

# This is my own bulletin board

**This book is probably outdated already.** (Unless it was just downloaded from <https://beginners.re/>.)

The book is [changing too often](#), content being added, bugs are (hopefully) being fixed. The latest version is always at <https://beginners.re/>.

This PDF you currently reading was compiled at February 29, 2020.

---

If you have printed this book on paper, can you please send me a picture of it, for collection? <first at last dot com> or <first dot last at gmail dot com>. The collection, so far: [https://yurichev.com/news/20200222\\_printed\\_RE4B/](https://yurichev.com/news/20200222_printed_RE4B/).

---

My dear readers! From time to time, I have questions, I don't know who (or where) to ask. Or I'm just lazy... Can you please help me?

---

In 1988 Jim Reuter wrote a VAX-assembly-to-C decompiler:

## WHY I WROTE IT:

To decompile Peter Langston's EMPIRE game and other goodies into source form. This was desired because I wanted to port the games to VMS and to fix some bugs in the games.

Read more about it: [1](#), [2](#).

Now, in order to understand this compiler better, I seek Peter Langston's EMPIRE game from 1980's. Did anyone hear about it?

---

When a process crashes in Windows 10, it doesn't offer a dialog box so that the user can pick JIT-debugger anymore, like it was in earlier versions. How to turn this on?

---

Can anyone help me with Low Fragmentation Heap in Windows?

---

Survey: how do you use DLL injection aside of API interception?

---

I've got a huge graph, for example,  $10^6$  nodes (vertices). I want to visualize it somehow, so that a user would navigate it using mouse. Clicked on link (edge) and moved to another node (vertex). Like in IDA. Maybe, using JavaScript. Are there any mature open-source solutions?

---

Do you remember "The Incredible Machine" videogame for DOS? Do you know about Rube Goldberg machines? What can be used today for simulating them? Some kind of physics engine, maybe?

---

The ERGO BT-590 bluetooth headphones have a touch control that is too sensitive and easy to hit with clothing. How to force Android ignore messages from headphones about buttons?

---

If you know something, please help me: <first at last dot com> or <first dot last at gmail dot com>.

REVERSE

Engineering

FOR

Beginners

# Reverse Engineering for Beginners

(Understanding Assembly Language)

Why two titles? Read here: [on page xiii](#).

Dennis Yurichev  
<first at last dot com>



©2013-2020, Dennis Yurichev.

This work is licensed under the Creative Commons Attribution-ShareAlike 4.0 International (CC BY-SA 4.0) license. To view a copy of this license, visit <https://creativecommons.org/licenses/by-sa/4.0/>.

Text version (February 29, 2020).

The latest version (and Russian edition) of this text is accessible at [beginners.re](http://beginners.re).

## Call for translators!

You may want to help me with translating this work into languages other than English and Russian. Just send me any piece of translated text (no matter how short) and I'll put it into my LaTeX source code.

[Read here](#).

The language statistics is available right here: <https://beginners.re/>.

Speed isn't important, because this is an open-source project, after all. Your name will be mentioned as a project contributor. Korean, Chinese, and Persian languages are reserved by publishers. English and Russian versions I do by myself, but my English is still that horrible, so I'm very grateful for any notes about grammar, etc. Even my Russian is flawed, so I'm grateful for notes about Russian text as well!

So do not hesitate to contact me: <first at last dot com> or <first dot last at gmail dot com>.

# Abridged contents

<b>1 Code Patterns</b>	<b>1</b>
<b>2 Important fundamentals</b>	<b>447</b>
<b>3 Slightly more advanced examples</b>	<b>468</b>
<b>4 Java</b>	<b>661</b>
<b>5 Finding important/interesting stuff in the code</b>	<b>702</b>
<b>6 OS-specific</b>	<b>735</b>
<b>7 Tools</b>	<b>791</b>
<b>8 Case studies</b>	<b>795</b>
<b>9 Examples of reversing proprietary file formats</b>	<b>922</b>
<b>10 Dynamic binary instrumentation</b>	<b>986</b>
<b>11 Other things</b>	<b>994</b>
<b>12 Books/blogs worth reading</b>	<b>1013</b>
<b>13 Communities</b>	<b>1016</b>
<b>Afterword</b>	<b>1018</b>
<b>Appendix</b>	<b>1020</b>
<b>Acronyms Used</b>	<b>1048</b>
<b>Glossary</b>	<b>1053</b>
<b>Index</b>	<b>1055</b>

# Contents

<b>1 Code Patterns</b>	<b>1</b>
1.1 The method	1
1.2 Some basics	2
1.2.1 A short introduction to the CPU	2
1.2.2 Numeral Systems	3
1.2.3 Converting From One Radix To Another	3
1.3 An Empty Function	5
1.3.1 x86	6
1.3.2 ARM	6
1.3.3 MIPS	6
1.3.4 Empty Functions in Practice	6
1.4 Returning Values	7
1.4.1 x86	7
1.4.2 ARM	7
1.4.3 MIPS	8
1.5 Hello, world!	8
1.5.1 x86	8
1.5.2 x86-64	14
1.5.3 ARM	18
1.5.4 MIPS	24
1.5.5 Conclusion	28
1.5.6 Exercises	29
1.6 Function prologue and epilogue	29
1.6.1 Recursion	29
1.7 An Empty Function: redux	29
1.8 Returning Values: redux	29
1.9 Stack	30
1.9.1 Why does the stack grow backwards?	30
1.9.2 What is the stack used for?	31
1.9.3 A typical stack layout	37
1.9.4 Noise in stack	37
1.9.5 Exercises	42
1.10 Almost empty function	42
1.11 printf() with several arguments	43
1.11.1 x86	43
1.11.2 ARM	54
1.11.3 MIPS	60
1.11.4 Conclusion	66
1.11.5 By the way	67
1.12 scanf()	67
1.12.1 Simple example	67
1.12.2 The classic mistake	76
1.12.3 Global variables	77
1.12.4 scanf()	86
1.12.5 Exercise	97
1.13 Worth noting: global vs. local variables	97
1.14 Accessing passed arguments	98
1.14.1 x86	98
1.14.2 x64	100
1.14.3 ARM	103
1.14.4 MIPS	106
1.15 More about results returning	107
1.15.1 Attempt to use the result of a function returning <i>void</i>	107

1.15.2	What if we do not use the function result?	108
1.15.3	Returning a structure	109
1.16	Pointers	110
1.16.1	Returning values	110
1.16.2	Swap input values	119
1.17	GOTO operator	120
1.17.1	Dead code	123
1.17.2	Exercise	124
1.18	Conditional jumps	124
1.18.1	Simple example	124
1.18.2	Calculating absolute value	141
1.18.3	Ternary conditional operator	143
1.18.4	Getting minimal and maximal values	146
1.18.5	Conclusion	150
1.18.6	Exercise	152
1.19	Software cracking	152
1.20	Impossible shutdown practical joke (Windows 7)	154
1.21	switch()/case/default	154
1.21.1	Small number of cases	154
1.21.2	A lot of cases	167
1.21.3	When there are several case statements in one block	179
1.21.4	Fall-through	183
1.21.5	Exercises	184
1.22	Loops	184
1.22.1	Simple example	184
1.22.2	Memory blocks copying routine	195
1.22.3	Condition check	198
1.22.4	Conclusion	199
1.22.5	Exercises	200
1.23	More about strings	201
1.23.1	strlen()	201
1.23.2	Boundaries of strings	212
1.24	Replacing arithmetic instructions to other ones	212
1.24.1	Multiplication	212
1.24.2	Division	217
1.24.3	Exercise	218
1.25	Floating-point unit	218
1.25.1	IEEE 754	218
1.25.2	x86	218
1.25.3	ARM, MIPS, x86/x64 SIMD	219
1.25.4	C/C++	219
1.25.5	Simple example	219
1.25.6	Passing floating point numbers via arguments	229
1.25.7	Comparison example	231
1.25.8	Some constants	265
1.25.9	Copying	265
1.25.10	Stack, calculators and reverse Polish notation	265
1.25.11	80 bits?	265
1.25.12	x64	265
1.25.13	Exercises	265
1.26	Arrays	266
1.26.1	Simple example	266
1.26.2	Buffer overflow	273
1.26.3	Buffer overflow protection methods	281
1.26.4	One more word about arrays	284
1.26.5	Array of pointers to strings	285
1.26.6	Multidimensional arrays	292
1.26.7	Pack of strings as a two-dimensional array	299
1.26.8	Conclusion	303
1.26.9	Exercises	303
1.27	Example: a bug in Angband	303
1.28	Manipulating specific bit(s)	305
1.28.1	Specific bit checking	305
1.28.2	Setting and clearing specific bits	309

1.28.3 Shifts	318
1.28.4 Setting and clearing specific bits: FPU <sup>1</sup> example	318
1.28.5 Counting bits set to 1	322
1.28.6 Conclusion	337
1.28.7 Exercises	339
1.29 Linear congruential generator	339
1.29.1 x86	340
1.29.2 x64	341
1.29.3 32-bit ARM	341
1.29.4 MIPS	342
1.29.5 Thread-safe version of the example	344
1.30 Structures	344
1.30.1 MSVC: SYSTEMTIME example	344
1.30.2 Let's allocate space for a structure using malloc()	348
1.30.3 UNIX: struct tm	349
1.30.4 Fields packing in structure	359
1.30.5 Nested structures	366
1.30.6 Bit fields in a structure	369
1.30.7 Exercises	376
1.31 The classic <i>struct</i> bug	376
1.32 Unions	377
1.32.1 Pseudo-random number generator example	377
1.32.2 Calculating machine epsilon	380
1.32.3 FSCALE instruction replacement	382
1.32.4 Fast square root calculation	383
1.33 Pointers to functions	384
1.33.1 MSVC	384
1.33.2 GCC	391
1.33.3 Danger of pointers to functions	395
1.34 64-bit values in 32-bit environment	395
1.34.1 Returning of 64-bit value	395
1.34.2 Arguments passing, addition, subtraction	396
1.34.3 Multiplication, division	399
1.34.4 Shifting right	403
1.34.5 Converting 32-bit value into 64-bit one	404
1.35 LARGE_INTEGER structure case	405
1.36 SIMD	408
1.36.1 Vectorization	408
1.36.2 SIMD strlen() implementation	418
1.37 64 bits	421
1.37.1 x86-64	421
1.37.2 ARM	428
1.37.3 Float point numbers	428
1.37.4 64-bit architecture criticism	428
1.38 Working with floating point numbers using SIMD	428
1.38.1 Simple example	428
1.38.2 Passing floating point number via arguments	436
1.38.3 Comparison example	437
1.38.4 Calculating machine epsilon: x64 and SIMD	438
1.38.5 Pseudo-random number generator example revisited	439
1.38.6 Summary	439
1.39 ARM-specific details	440
1.39.1 Number sign (#) before number	440
1.39.2 Addressing modes	440
1.39.3 Loading a constant into a register	441
1.39.4 Relocs in ARM64	443
1.40 MIPS-specific details	444
1.40.1 Loading a 32-bit constant into register	444
1.40.2 Further reading about MIPS	446
<b>2 Important fundamentals</b>	<b>447</b>
2.1 Integral datatypes	447
2.1.1 Bit	447

---

<sup>1</sup>Floating-Point Unit

2.1.2 Nibble AKA nybble	447
2.1.3 Byte	448
2.1.4 Wide char	449
2.1.5 Signed integer vs unsigned	449
2.1.6 Word	449
2.1.7 Address register	450
2.1.8 Numbers	451
2.2 Signed number representations	452
2.2.1 Using IMUL over MUL	454
2.2.2 Couple of additions about two's complement form	454
2.2.3 -1	455
2.3 Integer overflow	455
2.4 AND	457
2.4.1 Checking if a value is on $2^n$ boundary	457
2.4.2 KOI-8R Cyrillic encoding	457
2.5 AND and OR as subtraction and addition	458
2.5.1 ZX Spectrum ROM text strings	458
2.6 XOR (exclusive OR)	461
2.6.1 Logical difference	461
2.6.2 Everyday speech	461
2.6.3 Encryption	461
2.6.4 RAID <sup>2</sup>	461
2.6.5 XOR swap algorithm	461
2.6.6 XOR linked list	462
2.6.7 Switching value trick	463
2.6.8 Zobrist hashing / tabulation hashing	463
2.6.9 By the way	464
2.6.10 AND/OR/XOR as MOV	464
2.7 Population count	464
2.8 Endianness	464
2.8.1 Big-endian	465
2.8.2 Little-endian	465
2.8.3 Example	465
2.8.4 Bi-endian	465
2.8.5 Converting data	466
2.9 Memory	466
2.10 CPU	466
2.10.1 Branch predictors	466
2.10.2 Data dependencies	466
2.11 Hash functions	467
2.11.1 How do one-way functions work?	467
<b>3 Slightly more advanced examples</b>	<b>468</b>
3.1 Zero register	468
3.2 Double negation	471
3.3 const correctness	472
3.3.1 Overlapping const strings	473
3.4 strstr() example	474
3.5 qsort() revisited	474
3.6 Temperature converting	475
3.6.1 Integer values	475
3.6.2 Floating-point values	477
3.7 Fibonacci numbers	479
3.7.1 Example #1	479
3.7.2 Example #2	482
3.7.3 Summary	485
3.8 CRC32 calculation example	486
3.9 Network address calculation example	488
3.9.1 calc_network_address()	490
3.9.2 form_IP()	490
3.9.3 print_as_IP()	492
3.9.4 form_netmask() and set_bit()	493
3.9.5 Summary	494

---

<sup>2</sup>Redundant Array of Independent Disks



3.10	Loops: several iterators	494
3.10.1	Three iterators	494
3.10.2	Two iterators	495
3.10.3	Intel C++ 2011 case	497
3.11	Duff's device	498
3.11.1	Should one use unrolled loops?	500
3.12	Division using multiplication	500
3.12.1	x86	501
3.12.2	How it works	502
3.12.3	ARM	502
3.12.4	MIPS	503
3.12.5	Exercise	504
3.13	String to number conversion (atoi())	504
3.13.1	Simple example	504
3.13.2	A slightly advanced example	507
3.13.3	Exercise	510
3.14	Inline functions	510
3.14.1	Strings and memory functions	511
3.15	C99 restrict	519
3.16	Branchless <i>abs()</i> function	521
3.16.1	Optimizing GCC 4.9.1 x64	521
3.16.2	Optimizing GCC 4.9 ARM64	522
3.17	Variadic functions	522
3.17.1	Computing arithmetic mean	522
3.17.2	<i>vprintf()</i> function case	526
3.17.3	Pin case	527
3.17.4	Format string exploit	527
3.18	Strings trimming	528
3.18.1	x64: Optimizing MSVC 2013	529
3.18.2	x64: Non-optimizing GCC 4.9.1	531
3.18.3	x64: Optimizing GCC 4.9.1	532
3.18.4	ARM64: Non-optimizing GCC (Linaro) 4.9	533
3.18.5	ARM64: Optimizing GCC (Linaro) 4.9	534
3.18.6	ARM: Optimizing Keil 6/2013 (ARM mode)	534
3.18.7	ARM: Optimizing Keil 6/2013 (Thumb mode)	535
3.18.8	MIPS	536
3.19	<i>toupper()</i> function	537
3.19.1	x64	537
3.19.2	ARM	539
3.19.3	Using bit operations	540
3.19.4	Summary	541
3.20	Obfuscation	541
3.20.1	Text strings	541
3.20.2	Executable code	542
3.20.3	Virtual machine / pseudo-code	545
3.20.4	Other things to mention	545
3.20.5	Exercise	545
3.21	C++	545
3.21.1	Classes	545
3.21.2	<i>ostream</i>	562
3.21.3	References	563
3.21.4	STL	563
3.21.5	Memory	596
3.22	Negative array indices	597
3.22.1	Addressing string from the end	597
3.22.2	Addressing some kind of block from the end	598
3.22.3	Arrays started at 1	598
3.23	More about pointers	600
3.23.1	Working with addresses instead of pointers	600
3.23.2	Passing values as pointers; tagged unions	603
3.23.3	Pointers abuse in Windows kernel	604
3.23.4	Null pointers	608
3.23.5	Array as function argument	613
3.23.6	Pointer to a function	614

3.23.7 Pointer to a function: copy protection	614
3.23.8 Pointer to a function: a common bug (or typo)	615
3.23.9 Pointer as object identifier	616
3.23.10 Oracle RDBMS and a simple garbage collector for C/C++	617
3.24 Loop optimizations	618
3.24.1 Weird loop optimization	618
3.24.2 Another loop optimization	619
3.25 More about structures	621
3.25.1 Sometimes a C structure can be used instead of array	621
3.25.2 Unsized array in C structure	622
3.25.3 Version of C structure	623
3.25.4 High-score file in “Block out” game and primitive serialization	625
3.26 memmove() and memcpy()	629
3.26.1 Anti-debugging trick	630
3.27 setjmp/longjmp	630
3.28 Other weird stack hacks	633
3.28.1 Accessing arguments/local variables of caller	633
3.28.2 Returning string	634
3.29 OpenMP	636
3.29.1 MSVC	638
3.29.2 GCC	640
3.30 Signed division using shifts	641
3.31 Another heisenbug	643
3.32 The case of forgotten return	644
3.33 Homework: more about function pointers and unions	648
3.34 Windows 16-bit	649
3.34.1 Example#1	649
3.34.2 Example #2	650
3.34.3 Example #3	650
3.34.4 Example #4	652
3.34.5 Example #5	654
3.34.6 Example #6	657
<b>4 Java</b>	<b>661</b>
4.1 Java	661
4.1.1 Introduction	661
4.1.2 Returning a value	661
4.1.3 Simple calculating functions	666
4.1.4 JVM <sup>3</sup> memory model	669
4.1.5 Simple function calling	670
4.1.6 Calling beep()	671
4.1.7 Linear congruential PRNG <sup>4</sup>	672
4.1.8 Conditional jumps	673
4.1.9 Passing arguments	675
4.1.10 Bitfields	676
4.1.11 Loops	678
4.1.12 switch()	679
4.1.13 Arrays	680
4.1.14 Strings	689
4.1.15 Exceptions	691
4.1.16 Classes	694
4.1.17 Simple patching	696
4.1.18 Summary	701
<b>5 Finding important/interesting stuff in the code</b>	<b>702</b>
5.1 Identification of executable files	702
5.1.1 Microsoft Visual C++	702
5.1.2 GCC	703
5.1.3 Intel Fortran	703
5.1.4 Watcom, OpenWatcom	703
5.1.5 Borland	704
5.1.6 Other known DLLs	705

<sup>3</sup>Java Virtual Machine

<sup>4</sup>Pseudorandom Number Generator

5.2	Communication with outer world (function level)	705
5.3	Communication with the outer world (win32)	705
5.3.1	Often used functions in the Windows API	706
5.3.2	Extending trial period	706
5.3.3	Removing nag dialog box	706
5.3.4	tracer: Intercepting all functions in specific module	706
5.4	Strings	707
5.4.1	Text strings	707
5.4.2	Finding strings in binary	711
5.4.3	Error/debug messages	712
5.4.4	Suspicious magic strings	713
5.5	Calls to assert()	713
5.6	Constants	714
5.6.1	Magic numbers	714
5.6.2	Specific constants	716
5.6.3	Searching for constants	716
5.7	Finding the right instructions	716
5.8	Suspicious code patterns	718
5.8.1	XOR instructions	718
5.8.2	Hand-written assembly code	718
5.9	Using magic numbers while tracing	719
5.10	Loops	720
5.10.1	Some binary file patterns	720
5.10.2	Memory “snapshots” comparing	727
5.11	ISA <sup>5</sup> detection	729
5.11.1	Incorrectly disassembled code	729
5.11.2	Correctly disassembled code	734
5.12	Other things	734
5.12.1	General idea	734
5.12.2	Order of functions in binary code	734
5.12.3	Tiny functions	734
5.12.4	C++	734
5.12.5	Crash on purpose	734
<b>6</b>	<b>OS-specific</b>	<b>735</b>
6.1	Arguments passing methods (calling conventions)	735
6.1.1	cdecl	735
6.1.2	stdcall	735
6.1.3	fastcall	736
6.1.4	thiscall	737
6.1.5	x86-64	738
6.1.6	Return values of <i>float</i> and <i>double</i> type	740
6.1.7	Modifying arguments	741
6.1.8	Taking a pointer to function argument	741
6.1.9	Python ctypes problem (x86 assembly homework)	743
6.1.10	Cdecl example: a DLL	743
6.2	Thread Local Storage	744
6.2.1	Linear congruential generator revisited	744
6.3	System calls (syscall-s)	749
6.3.1	Linux	749
6.3.2	Windows	750
6.4	Linux	750
6.4.1	Position-independent code	750
6.4.2	LD_PRELOAD hack in Linux	752
6.5	Windows NT	755
6.5.1	CRT (win32)	755
6.5.2	Win32 PE	758
6.5.3	Windows SEH	766
6.5.4	Windows NT: Critical section	789
<b>7</b>	<b>Tools</b>	<b>791</b>
7.1	Binary analysis	791
7.1.1	Disassemblers	791

---

<sup>5</sup>Instruction Set Architecture

7.1.2	Decompilers	792
7.1.3	Patch comparison/diffing	792
7.2	Live analysis	792
7.2.1	Debuggers	792
7.2.2	Library calls tracing	792
7.2.3	System calls tracing	792
7.2.4	Network sniffing	793
7.2.5	Sysinternals	793
7.2.6	Valgrind	793
7.2.7	Emulators	793
7.3	Other tools	793
7.3.1	SMT solvers	793
7.3.2	Calculators	794
7.4	Do You Think Something Is Missing Here?	794
<b>8</b>	<b>Case studies</b>	<b>795</b>
8.1	Mahjong solitaire prank (Windows 7)	795
8.2	Task manager practical joke (Windows Vista)	797
8.2.1	Using LEA to load values	800
8.3	Color Lines game practical joke	802
8.4	Minesweeper (Windows XP)	805
8.4.1	Finding grid automatically	810
8.4.2	Exercises	811
8.5	Hacking Windows clock	811
8.6	(Windows 7) Solitaire: practical jokes	818
8.6.1	51 cards	818
8.6.2	53 cards	823
8.7	FreeCell prank (Windows 7)	824
8.7.1	Part I	824
8.7.2	Part II: breaking the <i>Select Game</i> submenu	828
8.8	Dongles	829
8.8.1	Example #1: MacOS Classic and PowerPC	829
8.8.2	Example #2: SCO OpenServer	837
8.8.3	Example #3: MS-DOS	846
8.9	Encrypted database case #1	851
8.9.1	Base64 and entropy	851
8.9.2	Is data compressed?	854
8.9.3	Is data encrypted?	855
8.9.4	CryptoPP	855
8.9.5	Cipher Feedback mode	857
8.9.6	Initializing Vector	859
8.9.7	Structure of the buffer	860
8.9.8	Noise at the end	862
8.9.9	Conclusion	863
8.9.10	Post Scriptum: brute-forcing IV <sup>6</sup>	863
8.10	Overclocking Cointerra Bitcoin miner	863
8.11	Breaking simple executable cryptor	868
8.11.1	Other ideas to consider	873
8.12	SAP	873
8.12.1	About SAP client network traffic compression	873
8.12.2	SAP 6.0 password checking functions	884
8.13	Oracle RDBMS	888
8.13.1	V\$VERSION table in the Oracle RDBMS	888
8.13.2	X\$KSMLRU table in Oracle RDBMS	895
8.13.3	V\$TIMER table in Oracle RDBMS	897
8.14	Handwritten assembly code	901
8.14.1	EICAR test file	901
8.15	Demos	902
8.15.1	10 PRINT CHR\$(205.5+RND(1)); : GOTO 10	902
8.15.2	Mandelbrot set	905
8.16	A nasty bug in MSVCRT.DLL	915
8.17	Other examples	921

<sup>6</sup>Initialization Vector

<b>9</b>	<b>Examples of reversing proprietary file formats</b>	<b>922</b>
9.1	Primitive XOR-encryption	922
9.1.1	Simplest ever XOR encryption	922
9.1.2	Norton Guide: simplest possible 1-byte XOR encryption	924
9.1.3	Simplest possible 4-byte XOR encryption	927
9.1.4	Simple encryption using XOR mask	931
9.1.5	Simple encryption using XOR mask, case II	938
9.1.6	Homework	943
9.2	Information entropy	944
9.2.1	Analyzing entropy in Mathematica	944
9.2.2	Conclusion	953
9.2.3	Tools	953
9.2.4	A word about primitive encryption like XORing	954
9.2.5	More about entropy of executable code	954
9.2.6	PRNG	954
9.2.7	More examples	954
9.2.8	Entropy of various files	954
9.2.9	Making lower level of entropy	956
9.3	Millenium game save file	956
9.4	<i>fortune</i> program indexing file	963
9.4.1	Hacking	967
9.4.2	The files	968
9.5	Oracle RDBMS: .SYM-files	968
9.6	Oracle RDBMS: .MSB-files	978
9.6.1	Summary	985
9.7	Exercises	985
9.8	Further reading	985
<b>10</b>	<b>Dynamic binary instrumentation</b>	<b>986</b>
10.1	Using PIN DBI for XOR interception	986
10.2	Cracking Minesweeper with PIN	989
10.2.1	Intercepting all rand() calls	989
10.2.2	Replacing rand() calls with our function	990
10.2.3	Peeking into placement of mines	991
10.2.4	Exercise	993
10.3	Building Pin	993
10.4	Why “instrumentation”?	993
<b>11</b>	<b>Other things</b>	<b>994</b>
11.1	Executable files patching	994
11.1.1	x86 code	994
11.2	Function arguments number statistics	994
11.3	Compiler intrinsic	995
11.4	Compiler’s anomalies	995
11.4.1	Oracle RDBMS 11.2 and Intel C++ 10.1	995
11.4.2	MSVC 6.0	996
11.4.3	ftol2() in MSVC 2012	996
11.4.4	Summary	997
11.5	Itanium	998
11.6	8086 memory model	1000
11.7	Basic blocks reordering	1001
11.7.1	Profile-guided optimization	1001
11.8	My experience with Hex-Rays 2.2.0	1002
11.8.1	Bugs	1002
11.8.2	Odd peculiarities	1004
11.8.3	Silence	1005
11.8.4	Comma	1007
11.8.5	Data types	1008
11.8.6	Long and messed expressions	1008
11.8.7	De Morgan’s laws and decompilation	1008
11.8.8	My plan	1010
11.8.9	Summary	1010
11.9	Cyclomatic complexity	1010
<b>12</b>	<b>Books/blogs worth reading</b>	<b>1013</b>

12.1 Books and other materials	.1013
12.1.1 Reverse Engineering	.1013
12.1.2 Windows	.1013
12.1.3 C/C++	.1013
12.1.4 x86 / x86-64	.1014
12.1.5 ARM	.1014
12.1.6 Assembly language	.1014
12.1.7 Java	.1014
12.1.8 UNIX	.1014
12.1.9 Programming in general	.1014
12.1.10 Cryptography	.1015
<b>13 Communities</b>	<b>1016</b>
<b>Afterword</b>	<b>1018</b>
13.1 Questions?	.1018
<b>Appendix</b>	<b>1020</b>
.1 x86	.1020
.1.1 Terminology	.1020
.1.2 General purpose registers	.1020
.1.3 FPU registers	.1024
.1.4 SIMD registers	.1026
.1.5 Debugging registers	.1026
.1.6 Instructions	.1027
.1.7 npad	.1039
.2 ARM	.1041
.2.1 Terminology	.1041
.2.2 Versions	.1041
.2.3 32-bit ARM (AArch32)	.1041
.2.4 64-bit ARM (AArch64)	.1042
.2.5 Instructions	.1042
.3 MIPS	.1043
.3.1 Registers	.1043
.3.2 Instructions	.1044
.4 Some GCC library functions	.1044
.5 Some MSVC library functions	.1044
.6 Cheatsheets	.1044
.6.1 IDA	.1044
.6.2 OllyDbg	.1045
.6.3 MSVC	.1045
.6.4 GCC	.1045
.6.5 GDB	.1046
<b>Acronyms Used</b>	<b>1048</b>
<b>Glossary</b>	<b>1053</b>
<b>Index</b>	<b>1055</b>

# Preface

## What is with two titles?

The book was named “Reverse Engineering for Beginners” in 2014-2018, but I always suspected this makes readership too narrow.

Infosec people know about “reverse engineering”, but I’ve rarely hear the “assembler” word from them.

Likewise, the “reverse engineering” term is somewhat cryptic to a general audience of programmers, but they know about “assembler”.

In July 2018, as an experiment, I’ve changed the title to “Assembly Language for Beginners” and posted the link to Hacker News website<sup>7</sup>, and the book was received generally well.

So let it be, the book now has two titles.

However, I’ve changed the second title to “Understanding Assembly Language”, because someone had already written “Assembly Language for Beginners” book. Also, people say “for Beginners” sounds a bit sarcastic for a book of ~1000 pages.

The two books differ only by title, filename (UAL-XX.pdf versus RE4B-XX.pdf), URL and a couple of the first pages.

## About reverse engineering

There are several popular meanings of the term “[reverse engineering](#)”:

- 1) The reverse engineering of software; researching compiled programs
- 2) The scanning of 3D structures and the subsequent digital manipulation required in order to duplicate them
- 3) Recreating [DBMS](#)<sup>8</sup> structure

This book is about the first meaning.

## Prerequisites

Basic knowledge of the C [PL](#)<sup>9</sup>. Recommended reading: [12.1.3 on page 1013](#).

## Exercises and tasks

...can be found at: <http://challenges.re>.

## Praise for this book

<https://beginners.re/#praise>.

## Universities

The book is recommended at least at these universities: <https://beginners.re/#uni>.

## Thanks

For patiently answering all my questions: Slava “Avid” Kazakov, SkullC0DEr.

For sending me notes about mistakes and inaccuracies: Stanislav “Beaver” Bobrytskyy, Alexander Ly-senko, Alexander “Solar Designer” Peslyak, Federico Ramondino, Mark Wilson, Xenia Galinskaya, Razikhova Meiramgul Kayratovna, Anatoly Prokofiev, Kostya Begunets, Valentin “netch” Nechayev, Aleksandr Plakhov, Artem Metla, Alexander Yastrebov, Vlad Golovkin<sup>10</sup>, Evgeny Proshin, Alexander Myasnikov, Zhu Ruijin, Changmin Heo, Vitor Vidal, Stijn Crevits, Jean-Gregoire Foulon<sup>11</sup>, Ben L., Etienne Khan, Norbert Szetei<sup>12</sup>,

<sup>7</sup><https://news.ycombinator.com/item?id=17549050>

<sup>8</sup>Database Management Systems

<sup>9</sup>Programming Language

<sup>10</sup>[goto-vlad@github](mailto:goto-vlad@github)

<sup>11</sup><https://github.com/pixjuan>

<sup>12</sup><https://github.com/73696e65>

Marc Remy, Michael Hansen, Derk Barten, The Renaissance<sup>13</sup>, Hugo Chan, Emil Mursalimov, Tanner Hoke, Tan90909090@GitHub, Ole Petter Orhagen, Sourav Punoriyar, Vitor Oliveira, Alexis Ehret, Maxim Shlochiski, Greg Paton, Pierrick Lebourgeois.

For helping me in other ways: Andrew Zubinski, Arnaud Patard (rtp on #debian-arm IRC), noshadow on #gcc IRC, Aliaksandr Autayeu, Mohsen Mostafa Jokar, Peter Sovietov, Misha “tiphareth” Verbitsky.

For translating the book into Simplified Chinese: Antiy Labs ([antiy.cn](http://antiy.cn)), Archer.

For translating the book into Korean: Byungho Min.

For translating the book into Dutch: Cedric Sambre (AKA Midas).

For translating the book into Spanish: Diego Boy, Luis Alberto Espinosa Calvo, Fernando Guida, Diogo Mussi, Patricio Galdames.

For translating the book into Portuguese: Thales Stevan de A. Gois, Diogo Mussi, Luiz Filipe.

For translating the book into Italian: Federico Ramondino<sup>14</sup>, Paolo Stivanin<sup>15</sup>, twyK, Fabrizio Bertone, Matteo Sticco, Marco Negro<sup>16</sup>.

For translating the book into French: Florent Besnard<sup>17</sup>, Marc Remy<sup>18</sup>, Baudouin Landais, Téo Dacquet<sup>19</sup>, BlueSkeye@GitHub<sup>20</sup>.

For translating the book into German: Dennis Siekmeier<sup>21</sup>, Julius Angres<sup>22</sup>, Dirk Loser<sup>23</sup>, Clemens Tamme.

For translating the book into Polish: Kateryna Rozanova, Aleksander Mistewicz, Wiktoria Lewicka.

For translating the book into Japanese: shmz@github<sup>24</sup>.

For proofreading: Alexander “Lstar” Chernenkiy, Vladimir Botov, Andrei Brazhuk, Mark “Logxen” Cooper, Yuan Jochen Kang, Mal Malakov, Lewis Porter, Jarle Thorsen, Hong Xie.

Vasil Kolev<sup>25</sup> did a great amount of work in proofreading and correcting many mistakes.

Thanks also to all the folks on github.com who have contributed notes and corrections.

Many  $\LaTeX$  packages were used: I would like to thank the authors as well.

## Donors

Those who supported me during the time when I wrote significant part of the book:

2 \* Oleg Vygovsky (50+100 UAH), Daniel Bilar (\$50), James Truscott (\$4.5), Luis Rocha (\$63), Joris van de Vis (\$127), Richard S Shultz (\$20), Jang Minchang (\$20), Shade Atlas (5 AUD), Yao Xiao (\$10), Pawel Szczur (40 CHF), Justin Simms (\$20), Shawn the R0ck (\$27), Ki Chan Ahn (\$50), Triop AB (100 SEK), Ange Albertini (€10+50), Sergey Lukianov (300 RUR), Ludvig Gislason (200 SEK), Gérard Labadie (€40), Sergey Volchkov (10 AUD), Vankayala Vigneswararao (\$50), Philippe Teuwen (\$4), Martin Haeberli (\$10), Victor Cazacov (€5), Tobias Sturzenegger (10 CHF), Sonny Thai (\$15), Bayna AlZaabi (\$75), Redfive B.V. (€25), Joona Oskari Heikkilä (€5), Marshall Bishop (\$50), Nicolas Werner (€12), Jeremy Brown (\$100), Alexandre Borges (\$25), Vladimir Dikovski (€50), Jiarui Hong (100.00 SEK), Jim Di (500 RUR), Tan Vincent (\$30), Sri Harsha Kandrakota (10 AUD), Pillay Harish (10 SGD), Timur Valiev (230 RUR), Carlos Garcia Prado (€10), Salikov Alexander (500 RUR), Oliver Whitehouse (30 GBP), Katy Moe (\$14), Maxim Dyakonov (\$3), Sebastian Aguilera (€20), Hans-Martin Münch (€15), Jarle Thorsen (100 NOK), Vitaly Osipov (\$100), Yuri Romanov (1000 RUR), Aliaksandr Autayeu (€10), Tudor Azoitei (\$40), Zovsky (€10), Yu Dai (\$10), Anonymous (\$15), Vladislav Chelnokov (\$25), Nenad Noveljic (\$50), Ryan Smith (\$25), Andreas Schommer (€5), Nikolay Gavrilo (€300).

Thanks a lot to every donor!

---

<sup>13</sup><https://github.com/TheRenaissance>

<sup>14</sup><https://github.com/pinkrab>

<sup>15</sup><https://github.com/paolostivanin>

<sup>16</sup><https://github.com/Internaut401>

<sup>17</sup><https://github.com/besnardf>

<sup>18</sup><https://github.com/mremy>

<sup>19</sup><https://github.com/T30rix>

<sup>20</sup><https://github.com/BlueSkeye>

<sup>21</sup><https://github.com/DSiekmeier>

<sup>22</sup><https://github.com/JAngres>

<sup>23</sup><https://github.com/PolymathMonkey>

<sup>24</sup><https://github.com/shmz>

<sup>25</sup><https://vasil.ludost.net/>



## mini-FAQ

Q: Is this book simpler/easier than others?

A: No, it is at about the same level as other books of this subject.

Q: I'm too frightened to start reading this book, there are more than 1000 pages. "...for Beginners" in the name sounds a bit sarcastic.

A: All sorts of listings are the bulk of the book. The book is indeed for beginners, there is a lot missing (yet).

Q: What are the prerequisites for reading this book?

A: A basic understanding of C/C++ is desirable.

Q: Should I really learn x86/x64/ARM and MIPS at once? Isn't it too much?

A: Starters can read about just x86/x64, while skipping or skimming the ARM and MIPS parts.

Q: Can I buy a Russian or English hard copy/paper book?

A: Unfortunately, no. No publisher got interested in publishing a Russian or English version so far. Meanwhile, you can ask your favorite copy shop to print and bind it. [https://yurichev.com/news/20200222\\_printed\\_RE4B/](https://yurichev.com/news/20200222_printed_RE4B/).

Q: Is there an epub or mobi version?

A: No. The book is highly dependent on TeX/LaTeX-specific hacks, so converting to HTML (epub/mobi are a set of HTMLs) would not be easy.

Q: Why should one learn assembly language these days?

A: Unless you are an [OS](#)<sup>26</sup> developer, you probably don't need to code in assembly—the latest compilers (2010s) are much better at performing optimizations than humans <sup>27</sup>.

Also, the latest [CPU](#)<sup>28</sup>s are very complex devices, and assembly knowledge doesn't really help towards understand their internals.

That being said, there are at least two areas where a good understanding of assembly can be helpful: First and foremost, for security/malware research. It is also a good way to gain a better understanding of your compiled code while debugging. This book is therefore intended for those who want to understand assembly language rather than to code in it, which is why there are many examples of compiler output contained within.

Q: I clicked on a hyperlink inside a PDF-document, how do I go back?

A: In Adobe Acrobat Reader click Alt+LeftArrow. In Evince click "<" button.

Q: May I print this book / use it for teaching?

A: Of course! That's why the book is licensed under the Creative Commons license (CC BY-SA 4.0).

Q: Why is this book free? You've done great job. This is suspicious, as with many other free things.

A: In my own experience, authors of technical literature write mostly for self-advertisement purposes. It's not possible to make any decent money from such work.

Q: How does one get a job in reverse engineering?

A: There are hiring threads that appear from time to time on reddit, devoted to RE<sup>29</sup>. Try looking there.

A somewhat related hiring thread can be found in the "netsec" subreddit.

Q: Compilers' versions in the book are outdated already...

A: No need to follow all steps precisely. Use the compilers you already have installed on your [OS](#). Also, there is: [Compiler Explorer](#).

Q: I have a question...

A: Send it to me by email (<first at last dot com> or <first dot last at gmail dot com>).

---

<sup>26</sup>Operating System

<sup>27</sup>A very good text on this topic: [Agner Fog, *The microarchitecture of Intel, AMD and VIA CPUs*, (2016)]

<sup>28</sup>Central Processing Unit

<sup>29</sup>[reddit.com/r/ReverseEngineering/](https://reddit.com/r/ReverseEngineering/)

## About the Korean translation

In January 2015, the Acorn publishing company ([www.acornpub.co.kr](http://www.acornpub.co.kr)) in South Korea did a huge amount of work in translating and publishing this book (as it was in August 2014) into Korean.

It's available now at [their website](#).

The translator is Byungho Min ([twitter/tais9](https://twitter.com/tais9)). The cover art was done by the artistic Andy Nechaevsky, a friend of the author: [facebook/andydinka](https://www.facebook.com/andydinka). Acorn also holds the copyright to the Korean translation.

So, if you want to have a *real* book on your shelf in Korean and want to support this work, it is now available for purchase.

## About the Persian/Farsi translation

In 2016 the book was translated by Mohsen Mostafa Jokar (who is also known to Iranian community for his translation of Radare manual<sup>30</sup>). It is available on the publisher's website<sup>31</sup> (Pendare Pars).

Here is a link to a 40-page excerpt: <https://beginners.re/farsi.pdf>.

National Library of Iran registration information: <http://opac.nlai.ir/opac-prod/bibliographic/4473995>.

## About the Chinese translation

In April 2017, translation to Chinese was completed by Chinese PTPress. They are also the Chinese translation copyright holders.

The Chinese version is available for order here: <http://www.epubit.com.cn/book/details/4174>. A partial review and history behind the translation can be found here: <http://www.cptoday.cn/news/detail/3155>.

The principal translator is Archer, to whom the author owes very much. He was extremely meticulous (in a good sense) and reported most of the known mistakes and bugs, which is very important in literature such as this book. The author would recommend his services to any other author!

The guys from [Antiy Labs](#) has also helped with translation. [Here is preface](#) written by them.

---

<sup>30</sup><http://rada.re/get/radare2book-persian.pdf>

<sup>31</sup><http://goo.gl/2Tzx0H>

# Chapter 1

## Code Patterns

### 1.1 The method

When the author of this book first started learning C and, later, C++, he used to write small pieces of code, compile them, and then look at the assembly language output. This made it very easy for him to understand what was going on in the code that he had written. <sup>1</sup> He did this so many times that the relationship between the C/C++ code and what the compiler produced was imprinted deeply in his mind. It's now easy for him to imagine instantly a rough outline of a C code's appearance and function. Perhaps this technique could be helpful for others.

By the way, there is a great website where you can do the same, with various compilers, instead of installing them on your box. You can use it as well: <https://godbolt.org/>.

### Exercises

When the author of this book studied assembly language, he also often compiled small C functions and then rewrote them gradually to assembly, trying to make their code as short as possible. This probably is not worth doing in real-world scenarios today, because it's hard to compete with the latest compilers in terms of efficiency. It is, however, a very good way to gain a better understanding of assembly. Feel free, therefore, to take any assembly code from this book and try to make it shorter. However, don't forget to test what you have written.

### Optimization levels and debug information

Source code can be compiled by different compilers with various optimization levels. A typical compiler has about three such levels, where level zero means that optimization is completely disabled. Optimization can also be targeted towards code size or code speed. A non-optimizing compiler is faster and produces more understandable (albeit verbose) code, whereas an optimizing compiler is slower and tries to produce code that runs faster (but is not necessarily more compact). In addition to optimization levels, a compiler can include some debug information in the resulting file, producing code that is easy to debug. One of the important features of the 'debug' code is that it might contain links between each line of the source code and its respective machine code address. Optimizing compilers, on the other hand, tend to produce output where entire lines of source code can be optimized away and thus not even be present in the resulting machine code. Reverse engineers can encounter either version, simply because some developers turn on the compiler's optimization flags and others do not. Because of this, we'll try to work on examples of both debug and release versions of the code featured in this book, wherever possible.

Sometimes some pretty ancient compilers are used in this book, in order to get the shortest (or simplest) possible code snippet.

---

<sup>1</sup>In fact, he still does this when he can't understand what a particular bit of code does. A recent example from the year 2019: `p += p+(i&1)+2;` from the "SAT0W" SAT-solver by D.Knuth.

## 1.2 Some basics

### 1.2.1 A short introduction to the CPU

The **CPU** is the device that executes the machine code a program consists of.

#### A short glossary:

**Instruction** : A primitive **CPU** command. The simplest examples include: moving data between registers, working with memory, primitive arithmetic operations. As a rule, each **CPU** has its own instruction set architecture (**ISA**).

**Machine code** : Code that the **CPU** directly processes. Each instruction is usually encoded by several bytes.

**Assembly language** : Mnemonic code and some extensions, like macros, that are intended to make a programmer's life easier.

**CPU register** : Each **CPU** has a fixed set of general purpose registers (**GPR**<sup>2</sup>).  $\approx 8$  in x86,  $\approx 16$  in x86-64, and also  $\approx 16$  in ARM. The easiest way to understand a register is to think of it as an untyped temporary variable. Imagine if you were working with a high-level **PL** and could only use eight 32-bit (or 64-bit) variables. Yet a lot can be done using just these!

One might wonder why there needs to be a difference between machine code and a **PL**. The answer lies in the fact that humans and **CPUs** are not alike—it is much easier for humans to use a high-level **PL** like C/C++, Java, or Python, but it is easier for a **CPU** to use a much lower level of abstraction. Perhaps it would be possible to invent a **CPU** that can execute high-level **PL** code, but it would be many times more complex than the **CPUs** we know of today. In a similar fashion, it is very inconvenient for humans to write in assembly language, due to it being so low-level and difficult to write in without making a huge number of annoying mistakes. The program that converts the high-level **PL** code into assembly is called a *compiler*.<sup>3</sup>

#### A couple of words about different **ISAs**

The x86 **ISA** has always had variable-length instructions, so when the 64-bit era came, the x64 extensions did not impact the **ISA** very significantly. In fact, the x86 **ISA** still contains a lot of instructions that first appeared in 16-bit 8086 CPU, yet are still found in the CPUs of today. ARM is a **RISC**<sup>4</sup> **CPU** designed with constant-length instructions in mind, which had some advantages in the past. In the very beginning, all ARM instructions were encoded in 4 bytes<sup>5</sup>. This is now referred to as “ARM mode”. Then they realized it wasn't as frugal as they first imagined. In fact, the most common **CPU** instructions<sup>6</sup> in real world applications can be encoded using less information. They therefore added another **ISA**, called Thumb, in which each instruction was encoded in just 2 bytes. This is now referred to as “Thumb mode”. However, not *all* ARM instructions can be encoded in just 2 bytes, so the Thumb instruction set is somewhat limited. It is worth noting that code compiled for ARM mode and Thumb mode can coexist within one single program. The ARM creators thought Thumb could be extended, giving rise to Thumb-2, which appeared in ARMv7. Thumb-2 still uses 2-byte instructions, but has some new instructions which have the size of 4 bytes. There is a common misconception that Thumb-2 is a mix of ARM and Thumb. This is incorrect. Rather, Thumb-2 was extended to fully support all processor features so it could compete with ARM mode—a goal that was clearly achieved, as the majority of applications for iPod/iPhone/iPad are compiled for the Thumb-2 instruction set. (Though, admittedly, this is largely due to the fact that Xcode does this by default). Later the 64-bit ARM came out. This **ISA** has 4-byte instructions, and lacked the need of any additional Thumb mode. However, the 64-bit requirements affected the **ISA**, resulting in us now having three ARM instruction sets: ARM mode, Thumb mode (including Thumb-2) and ARM64. These **ISAs** intersect partially, but it can be said that they are different **ISAs**, rather than variations of the same one. Therefore, we will try to add fragments of code in all three ARM **ISAs** in this book. There are, by the way, many other **RISC ISAs** with fixed length 32-bit instructions, such as MIPS, PowerPC and Alpha AXP.

<sup>2</sup>General Purpose Registers

<sup>3</sup>Old-school Russian literature also uses the term “translator”.

<sup>4</sup>Reduced Instruction Set Computing

<sup>5</sup>Fixed-length instructions are handy because one can calculate the next (or previous) instruction address without effort. This feature will be discussed in the switch() operator ( 1.21.2 on page 174) section.

<sup>6</sup>e.g. MOV/PUSH/CALL/Jcc

## 1.2.2 Numeral Systems

Nowadays octal numbers seem to be used for exactly one purpose—file permissions on POSIX systems—but hexadecimal numbers are widely used to emphasize the bit pattern of a number over its numeric value.

---

Alan A. A. Donovan, Brian W. Kernighan —  
The Go Programming Language

Humans have become accustomed to a decimal numeral system, probably because almost everyone has 10 fingers. Nevertheless, the number “10” has no significant meaning in science and mathematics. The natural numeral system in digital electronics is binary: 0 is for an absence of current in the wire, and 1 for presence. 10 in binary is 2 in decimal, 100 in binary is 4 in decimal, and so on.

If the numeral system has 10 digits, it has a *radix* (or *base*) of 10. The binary numeral system has a *radix* of 2.

Important things to recall:

- 1) A *number* is a number, while a *digit* is a term from writing systems, and is usually one character
- 2) The value of a number does not change when converted to another radix; only the writing notation for that value has changed (and therefore the way of representing it in [RAM](#)<sup>7</sup>).

## 1.2.3 Converting From One Radix To Another

Positional notation is used in almost every numerical system. This means that a digit has weight relative to where it is placed inside of the larger number. If 2 is placed at the rightmost place, it's 2, but if it's placed one digit before rightmost, it's 20.

What does 1234 stand for?

$$10^3 \cdot 1 + 10^2 \cdot 2 + 10^1 \cdot 3 + 1 \cdot 4 = 1234 \text{ or } 1000 \cdot 1 + 100 \cdot 2 + 10 \cdot 3 + 4 = 1234$$

It's the same story for binary numbers, but the base is 2 instead of 10. What does 0b101011 stand for?

$$2^5 \cdot 1 + 2^4 \cdot 0 + 2^3 \cdot 1 + 2^2 \cdot 0 + 2^1 \cdot 1 + 2^0 \cdot 1 = 43 \text{ or } 32 \cdot 1 + 16 \cdot 0 + 8 \cdot 1 + 4 \cdot 0 + 2 \cdot 1 + 1 = 43$$

There is such a thing as non-positional notation, such as the Roman numeral system.<sup>8</sup> Perhaps, humankind switched to positional notation because it's easier to do basic operations (addition, multiplication, etc.) on paper by hand.

Binary numbers can be added, subtracted and so on in the very same as taught in schools, but only 2 digits are available.

Binary numbers are bulky when represented in source code and dumps, so that is where the hexadecimal numeral system can be useful. A hexadecimal radix uses the digits 0..9, and also 6 Latin characters: A..F. Each hexadecimal digit takes 4 bits or 4 binary digits, so it's very easy to convert from binary number to hexadecimal and back, even manually, in one's mind.

hexadecimal	binary	decimal
0	0000	0
1	0001	1
2	0010	2
3	0011	3
4	0100	4
5	0101	5
6	0110	6
7	0111	7
8	1000	8
9	1001	9
A	1010	10
B	1011	11
C	1100	12
D	1101	13
E	1110	14

---

<sup>7</sup>Random-Access Memory

<sup>8</sup>About numeric system evolution, see [Donald E. Knuth, *The Art of Computer Programming*, Volume 2, 3rd ed., (1997), 195–213.]

How can one tell which radix is being used in a specific instance?

Decimal numbers are usually written as is, i.e., 1234. Some assemblers allow an identifier on decimal radix numbers, in which the number would be written with a "d" suffix: 1234d.

Binary numbers are sometimes prepended with the "0b" prefix: 0b100110111 ([GCC<sup>9</sup>](#) has a non-standard language extension for this<sup>10</sup>). There is also another way: using a "b" suffix, for example: 100110111b. This book tries to use the "0b" prefix consistently throughout the book for binary numbers.

Hexadecimal numbers are prepended with "0x" prefix in C/C++ and other [PLs](#): 0x1234ABCD. Alternatively, they are given a "h" suffix: 1234ABCDh. This is common way of representing them in assemblers and debuggers. In this convention, if the number is started with a Latin (A..F) digit, a 0 is added at the beginning: 0ABCDEFh. There was also convention that was popular in 8-bit home computers era, using \$ prefix, like \$ABCD. The book will try to stick to "0x" prefix throughout the book for hexadecimal numbers.

Should one learn to convert numbers mentally? A table of 1-digit hexadecimal numbers can easily be memorized. As for larger numbers, it's probably not worth tormenting yourself.

Perhaps the most visible hexadecimal numbers are in [URL<sup>11</sup>](#)s. This is the way that non-Latin characters are encoded. For example: <https://en.wiktionary.org/wiki/na%C3%AFvet%C3%A9> is the [URL](#) of Wiktionary article about "naïveté" word.

## Octal Radix

Another numeral system heavily used in the past of computer programming is octal. In octal there are 8 digits (0..7), and each is mapped to 3 bits, so it's easy to convert numbers back and forth. It has been superseded by the hexadecimal system almost everywhere, but, surprisingly, there is a \*NIX utility, used often by many people, which takes octal numbers as argument: `chmod`.

As many \*NIX users know, `chmod` argument can be a number of 3 digits. The first digit represents the rights of the owner of the file (read, write and/or execute), the second is the rights for the group to which the file belongs, and the third is for everyone else. Each digit that `chmod` takes can be represented in binary form:

decimal	binary	meaning
7	111	<b>rwX</b>
6	110	<b>rw-</b>
5	101	<b>r-x</b>
4	100	<b>r--</b>
3	011	<b>-wX</b>
2	010	<b>-w-</b>
1	001	<b>--X</b>
0	000	<b>---</b>

So each bit is mapped to a flag: read/write/execute.

The importance of `chmod` here is that the whole number in argument can be represented as octal number. Let's take, for example, 644. When you run `chmod 644 file`, you set read/write permissions for owner, read permissions for group and again, read permissions for everyone else. If we convert the octal number 644 to binary, it would be 110100100, or, in groups of 3 bits, 110 100 100.

Now we see that each triplet describe permissions for owner/group/others: first is `rw-`, second is `r--` and third is `r--`.

The octal numeral system was also popular on old computers like PDP-8, because word there could be 12, 24 or 36 bits, and these numbers are all divisible by 3, so the octal system was natural in that environment. Nowadays, all popular computers employ word/address sizes of 16, 32 or 64 bits, and these numbers are all divisible by 4, so the hexadecimal system is more natural there.

<sup>9</sup>GNU Compiler Collection

<sup>10</sup><https://gcc.gnu.org/onlinedocs/gcc/Binary-constants.html>

<sup>11</sup>Uniform Resource Locator

The octal numeral system is supported by all standard C/C++ compilers. This is a source of confusion sometimes, because octal numbers are encoded with a zero prepended, for example, 0377 is 255. Sometimes, you might make a typo and write "09" instead of 9, and the compiler would report an error. GCC might report something like this:  
error: invalid digit "9" in octal constant.

Also, the octal system is somewhat popular in Java. When the IDA shows Java strings with non-printable characters, they are encoded in the octal system instead of hexadecimal. The JAD Java decompiler behaves the same way.

## Divisibility

When you see a decimal number like 120, you can quickly deduce that it's divisible by 10, because the last digit is zero. In the same way, 123400 is divisible by 100, because the two last digits are zeros.

Likewise, the hexadecimal number 0x1230 is divisible by 0x10 (or 16), 0x123000 is divisible by 0x1000 (or 4096), etc.

The binary number 0b1000101000 is divisible by 0b1000 (8), etc.

This property can often be used to quickly realize if an address or a size of some block in memory is padded to some boundary. For example, sections in PE<sup>12</sup> files are almost always started at addresses ending with 3 hexadecimal zeros: 0x41000, 0x10001000, etc. The reason behind this is the fact that almost all PE sections are padded to a boundary of 0x1000 (4096) bytes.

## Multi-Precision Arithmetic and Radix

Multi-precision arithmetic can use huge numbers, and each one may be stored in several bytes. For example, RSA keys, both public and private, span up to 4096 bits, and maybe even more.

In [Donald E. Knuth, *The Art of Computer Programming*, Volume 2, 3rd ed., (1997), 265] we find the following idea: when you store a multi-precision number in several bytes, the whole number can be represented as having a radix of  $2^8 = 256$ , and each digit goes to the corresponding byte. Likewise, if you store a multi-precision number in several 32-bit integer values, each digit goes to each 32-bit slot, and you may think about this number as stored in radix of  $2^{32}$ .

## How to Pronounce Non-Decimal Numbers

Numbers in a non-decimal base are usually pronounced by digit by digit: "one-zero-zero-one-one-...". Words like "ten" and "thousand" are usually not pronounced, to prevent confusion with the decimal base system.

## Floating point numbers

To distinguish floating point numbers from integers, they are usually written with ".0" at the end, like 0.0, 123.0, etc.

## 1.3 An Empty Function

The simplest possible function is arguably one that does nothing:

Listing 1.1: C/C++ Code

```
void f()
{
    return;
};
```

Let's compile it!

---

<sup>12</sup>Portable Executable

### 1.3.1 x86

Here's what both the GCC and MSVC compilers produce on the x86 platform:

Listing 1.2: Optimizing GCC/MSVC (assembly output)

```
f:
    ret
```

There is just one instruction: RET, which returns execution to the [caller](#).

### 1.3.2 ARM

Listing 1.3: Optimizing Keil 6/2013 (ARM mode) assembly output

```
f
    PROC
    BX     lr
    ENDP
```

The return address is not saved on the local stack in the ARM [ISA](#), but rather in the link register, so the BX LR instruction causes execution to jump to that address—effectively returning execution to the [caller](#).

### 1.3.3 MIPS

There are two naming conventions used in the world of MIPS when naming registers: by number (from \$0 to \$31) or by pseudo name (\$V0, \$A0, etc.).

The GCC assembly output below lists registers by number:

Listing 1.4: Optimizing GCC 4.4.5 (assembly output)

```
j      $31
nop
```

...while [IDA<sup>13</sup>](#) does it by pseudo name:

Listing 1.5: Optimizing GCC 4.4.5 (IDA)

```
j      $ra
nop
```

The first instruction is the jump instruction (J or JR) which returns the execution flow to the [caller](#), jumping to the address in the \$31 (or \$RA) register.

This is the register analogous to [LR<sup>14</sup>](#) in ARM.

The second instruction is [NOP<sup>15</sup>](#), which does nothing. We can ignore it for now.

#### A Note About MIPS Instructions and Register Names

Register and instruction names in the world of MIPS are traditionally written in lowercase. However, for the sake of consistency, this book will stick to using uppercase letters, as it is the convention followed by all the other [ISAs](#) featured in this book.

### 1.3.4 Empty Functions in Practice

Despite the fact empty functions seem useless, they are quite frequent in low-level code.

First of all, they are quite popular in debugging functions, like this one:

Listing 1.6: C/C++ code

```
void dbg_print (const char *fmt, ...)
{
#ifdef _DEBUG
    // open log file
```

<sup>13</sup> Interactive Disassembler and Debugger developed by [Hex-Rays](#)

<sup>14</sup> Link Register

<sup>15</sup> No Operation



```

        // write to log file
        // close log file
#endif
};

void some_function()
{
    ...

    dbg_print ("we did something\n");

    ...
};

```

In a non-debug build (as in a “release”), `_DEBUG` is not defined, so the `dbg_print()` function, despite still being called during execution, will be empty.

Similarly, a popular method of software protection is to make one build for legal customers, and another demo build. A demo build can lack some important functions, as with this example:

Listing 1.7: C/C++ code

```

void save_file ()
{
#ifdef DEMO
    // a real saving code
#endif
};

```

The `save_file()` function can be called when the user clicks File->Save on the menu. The demo version may be delivered with this menu item disabled, but even if a software cracker will enable it, only an empty function with no useful code will be called.

IDA marks such functions with names like `nullsub_00`, `nullsub_01`, etc.

## 1.4 Returning Values

Another simple function is the one that simply returns a constant value:

Listing 1.8: C/C++ Code

```

int f()
{
    return 123;
};

```

Let’s compile it.

### 1.4.1 x86

Here’s what both the GCC and MSVC compilers produce (with optimization) on the x86 platform:

Listing 1.9: Optimizing GCC/MSVC (assembly output)

```

f:
    mov     eax, 123
    ret

```

There are just two instructions: the first places the value 123 into the EAX register, which is used by convention for storing the return value, and the second one is RET, which returns execution to the [caller](#).

The caller will take the result from the EAX register.

### 1.4.2 ARM

There are a few differences on the ARM platform:

Listing 1.10: Optimizing Keil 6/2013 (ARM mode) ASM Output

```
f
    PROC
    MOV     r0,#0x7b ; 123
    BX     lr
    ENDP
```

ARM uses the register R0 for returning the results of functions, so 123 is copied into R0.

It is worth noting that MOV is a misleading name for the instruction in both the x86 and ARM ISAs.

The data is not in fact *moved*, but *copied*.

### 1.4.3 MIPS

The GCC assembly output below lists registers by number:

Listing 1.11: Optimizing GCC 4.4.5 (assembly output)

```
j      $31
li     $2,123          # 0x7b
```

...while IDA does it by their pseudo names:

Listing 1.12: Optimizing GCC 4.4.5 (IDA)

```
jr     $ra
li     $v0, 0x7B
```

The \$2 (or \$V0) register is used to store the function’s return value. LI stands for “Load Immediate” and is the MIPS equivalent to MOV.

The other instruction is the jump instruction (J or JR) which returns the execution flow to the [caller](#).

You might be wondering why the positions of the load instruction (LI) and the jump instruction (J or JR) are swapped. This is due to a [RISC](#) feature called “branch delay slot”.

The reason this happens is a quirk in the architecture of some RISC ISAs and isn’t important for our purposes—we must simply keep in mind that in MIPS, the instruction following a jump or branch instruction is executed *before* the jump/branch instruction itself.

As a consequence, branch instructions always swap places with the instruction executed immediately beforehand.

In practice, functions which merely return 1 (*true*) or 0 (*false*) are very frequent.

The smallest ever of the standard UNIX utilities, `/bin/true` and `/bin/false` return 0 and 1 respectively, as an exit code. (Zero as an exit code usually means success, non-zero means error.)

## 1.5 Hello, world!

Let’s use the famous example from the book [Brian W. Kernighan, Dennis M. Ritchie, *The C Programming Language*, 2ed, (1988)]:

Listing 1.13: C/C++ Code

```
#include <stdio.h>

int main()
{
    printf("hello, world\n");
    return 0;
}
```

### 1.5.1 x86

#### MSVC

Let’s compile it in MSVC 2010:

```
cl 1.cpp /Fa1.asm
```

(The /Fa option instructs the compiler to generate an assembly listing file)

Listing 1.14: MSVC 2010

```
CONST SEGMENT
$SG3830 DB 'hello, world', 0AH, 00H
CONST ENDS
PUBLIC _main
EXTRN _printf:PROC
; Function compile flags: /Odtp
_TEXT SEGMENT
_main PROC
    push    ebp
    mov     ebp, esp
    push    OFFSET $SG3830
    call   _printf
    add     esp, 4
    xor     eax, eax
    pop     ebp
    ret     0
_main ENDP
_TEXT ENDS
```

MSVC produces assembly listings in Intel-syntax. The differences between Intel-syntax and AT&T-syntax will be discussed in [1.5.1 on page 11](#).

The compiler generated the file, 1.obj, which is to be linked into 1.exe. In our case, the file contains two segments: CONST (for data constants) and \_TEXT (for code).

The string `hello, world` in C/C++ has type `const char[]` [Bjarne Stroustrup, *The C++ Programming Language, 4th Edition*, (2013)p176, 7.3.2], but it does not have its own name. The compiler needs to deal with the string somehow, so it defines the internal name `$SG3830` for it.

That is why the example may be rewritten as follows:

```
#include <stdio.h>

const char $SG3830[]="hello, world\n";

int main()
{
    printf($SG3830);
    return 0;
}
```

Let's go back to the assembly listing. As we can see, the string is terminated by a zero byte, which is standard for C/C++ strings. More about C/C++ strings: [5.4.1 on page 707](#).

In the code segment, \_TEXT, there is only one function so far: `main()`. The function `main()` starts with prologue code and ends with epilogue code (like almost any function) <sup>16</sup>.

After the function prologue we see the call to the `printf()` function:

CALL `_printf`. Before the call, a string address (or a pointer to it) containing our greeting is placed on the stack with the help of the PUSH instruction.

When the `printf()` function returns the control to the `main()` function, the string address (or a pointer to it) is still on the stack. Since we do not need it anymore, the [stack pointer](#) (the ESP register) needs to be corrected.

ADD ESP, 4 means add 4 to the ESP register value.

Why 4? Since this is a 32-bit program, we need exactly 4 bytes for address passing through the stack. If it was x64 code we would need 8 bytes. ADD ESP, 4 is effectively equivalent to POP register but without using any register<sup>17</sup>.

<sup>16</sup>You can read more about it in the section about function prologues and epilogues ( [1.6 on page 29](#)).

<sup>17</sup>CPU flags, however, are modified

For the same purpose, some compilers (like the Intel C++ Compiler) may emit POP ECX instead of ADD (e.g., such a pattern can be observed in the Oracle RDBMS code as it is compiled with the Intel C++ compiler). This instruction has almost the same effect but the ECX register contents will be overwritten. The Intel C++ compiler supposedly uses POP ECX since this instruction's opcode is shorter than ADD ESP, x (1 byte for POP against 3 for ADD).

Here is an example of using POP instead of ADD from Oracle RDBMS:

Listing 1.15: Oracle RDBMS 10.2 Linux (app.o file)

```
.text:0800029A      push    ebx
.text:0800029B      call   qksfroChild
.text:080002A0      pop     ecx
```

However, MSVC can do the same.

Listing 1.16: Minesweeper from Windows 7 32-bit

```
.text:0102106F      push    0
.text:01021071      call   ds:time
.text:01021077      pop     ecx
```

After calling printf(), the original C/C++ code contains the statement return 0 —return 0 as the result of the main() function.

In the generated code this is implemented by the instruction XOR EAX, EAX.

XOR is in fact just “eXclusive OR”<sup>18</sup> but the compilers often use it instead of MOV EAX, 0—again because it is a slightly shorter opcode (2 bytes for XOR against 5 for MOV).

Some compilers emit SUB EAX, EAX, which means *SUBtract the value in the EAX from the value in EAX*. That in any case will result in zero.

The last instruction RET returns the control to the caller. Usually, this is C/C++ CRT<sup>19</sup> code which in turn returns control to the OS.

## GCC

Now let's try to compile the same C/C++ code in the GCC 4.4.1 compiler in Linux: gcc 1.c -o 1. Next, with the assistance of the IDA disassembler, let's see how the main() function was created. IDA, like MSVC, uses Intel-syntax<sup>20</sup>.

Listing 1.17: code in IDA

```
main          proc near
var_10        = dword ptr -10h

              push    ebp
              mov     ebp, esp
              and     esp, 0FFFFFF0h
              sub     esp, 10h
              mov     eax, offset aHelloWorld ; "hello, world\n"
              mov     [esp+10h+var_10], eax
              call   _printf
              mov     eax, 0
              leave
              retn
main          endp
```

The result is almost the same. The address of the hello, world string (stored in the data segment) is loaded in the EAX register first, and then saved onto the stack.

In addition, the function prologue has AND ESP, 0FFFFFF0h —this instruction aligns the ESP register value on a 16-byte boundary. This results in all values in the stack being aligned the same way (The CPU

<sup>18</sup>Wikipedia

<sup>19</sup>C Runtime library

<sup>20</sup>We could also have GCC produce assembly listings in Intel-syntax by applying the options -S -masm=intel.

performs better if the values it is dealing with are located in memory at addresses aligned on a 4-byte or 16-byte boundary).

SUB ESP, 10h allocates 16 bytes on the stack. Although, as we can see hereafter, only 4 are necessary here.

This is because the size of the allocated stack is also aligned on a 16-byte boundary.

The string address (or a pointer to the string) is then stored directly onto the stack without using the PUSH instruction. `var_10` —is a local variable and is also an argument for `printf()`. Read about it below.

Then the `printf()` function is called.

Unlike MSVC, when GCC is compiling without optimization turned on, it emits `MOV EAX, 0` instead of a shorter opcode.

The last instruction, `LEAVE` —is the equivalent of the `MOV ESP, EBP` and `POP EBP` instruction pair —in other words, this instruction sets the [stack pointer](#) (ESP) back and restores the EBP register to its initial state. This is necessary since we modified these register values (ESP and EBP) at the beginning of the function (by executing `MOV EBP, ESP / AND ESP, ...`).

### GCC: AT&T syntax

Let's see how this can be represented in assembly language AT&T syntax. This syntax is much more popular in the UNIX-world.

Listing 1.18: let's compile in GCC 4.7.3

```
gcc -S 1_1.c
```

We get this:

Listing 1.19: GCC 4.7.3

```
.file "1_1.c"
.section .rodata
.LC0:
.string "hello, world\n"
.text
.globl main
.type main, @function
main:
.LFB0:
.cfi_startproc
pushl %ebp
.cfi_def_cfa_offset 8
.cfi_offset 5, -8
movl %esp, %ebp
.cfi_def_cfa_register 5
andl $-16, %esp
subl $16, %esp
movl $.LC0, (%esp)
call printf
movl $0, %eax
leave
.cfi_restore 5
.cfi_def_cfa 4, 4
ret
.cfi_endproc
.LFE0:
.size main, .-main
.ident "GCC: (Ubuntu/Linaro 4.7.3-1ubuntu1) 4.7.3"
.section .note.GNU-stack,"",@progbits
```

The listing contains many macros (the parts that begin with a dot). These are not interesting for us at the moment.

For now, for the sake of simplicity, we can ignore them (except the `.string` macro which encodes a null-terminated character sequence just like a C-string). Then we'll see this <sup>21</sup>:

<sup>21</sup>This GCC option can be used to eliminate "unnecessary" macros: `-fno-asynchronous-unwind-tables`

```

.LC0:
.string "hello, world\n"
main:
    pushl   %ebp
    movl   %esp, %ebp
    andl   $-16, %esp
    subl   $16, %esp
    movl   $.LC0, (%esp)
    call  printf
    movl   $0, %eax
    leave
    ret

```

Some of the major differences between Intel and AT&T syntax are:

- Source and destination operands are written in opposite order.

In Intel-syntax: <instruction> <destination operand> <source operand>.

In AT&T syntax: <instruction> <source operand> <destination operand>.

Here is an easy way to memorize the difference: when you deal with Intel-syntax, you can imagine that there is an equality sign (=) between operands and when you deal with AT&T-syntax imagine there is a right arrow (→) <sup>22</sup>.

- AT&T: Before register names, a percent sign must be written (%) and before numbers a dollar sign (\$). Parentheses are used instead of brackets.
- AT&T: A suffix is added to instructions to define the operand size:
  - q — quad (64 bits)
  - l — long (32 bits)
  - w — word (16 bits)
  - b — byte (8 bits)

To go back to the compiled result: it is almost identical to what was displayed by IDA. There is one subtle difference: 0FFFFFFF0h is presented as \$-16. It's the same thing: 16 in the decimal system is 0x10 in hexadecimal. -0x10 is equal to 0xFFFFFFF0 (for a 32-bit data type).

One more thing: the return value is set to 0 by using the usual MOV, not XOR. MOV just loads a value to a register. Its name is a misnomer (as the data is not moved but rather copied). In other architectures, this instruction is named "LOAD" or "STORE" or something similar.

## String patching (Win32)

We can easily find the "hello, world" string in the executable file using Hiew:

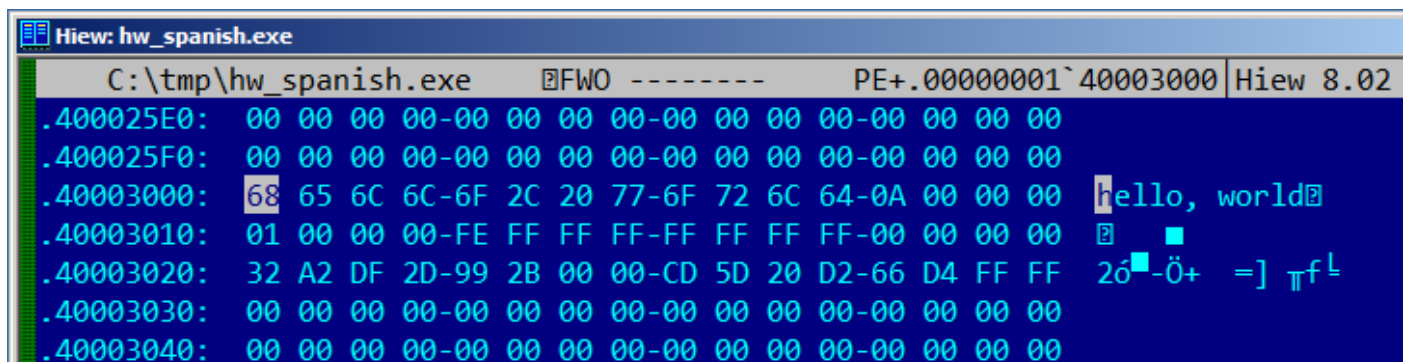

Figure 1.1: Hiew

And we can try to translate our message into Spanish:

<sup>22</sup>By the way, in some C standard functions (e.g., memcpy(), strcpy()) the arguments are listed in the same way as in Intel-syntax: first the pointer to the destination memory block, and then the pointer to the source memory block.

```

Hiew: hw_spanish.exe
C:\tmp\hw_spanish.exe  FWO EDITMODE  PE+ 00000000`0000120D Hiew 8.02
000011E0: 00 00 00 00-00 00 00 00-00 00 00 00-00 00 00 00
000011F0: 00 00 00 00-00 00 00 00-00 00 00 00-00 00 00 00
00001200: 68 6F 6C 61-2C 20 6D 75-6E 64 6F 0A-00 00 00 00 hola, mundo
00001210: 01 00 00 00-FE FF FF FF-FF FF FF FF-00 00 00 00
00001220: 32 A2 DF 2D-99 2B 00 00-CD 5D 20 D2-66 D4 FF FF 2ó-Ö+ =] ¶fL
00001230: 00 00 00 00-00 00 00 00-00 00 00 00-00 00 00 00
00001240: 00 00 00 00-00 00 00 00-00 00 00 00-00 00 00 00

```

Figure 1.2: Hiew

The Spanish text is one byte shorter than English, so we also added the 0x0A byte at the end (\n) with a zero byte.

It works.

What if we want to insert a longer message? There are some zero bytes after original English text. It's hard to say if they can be overwritten: they may be used somewhere in CRT code, or maybe not. Anyway, only overwrite them if you really know what you're doing.

### String patching (Linux x64)

Let's try to patch a Linux x64 executable using rada.re:

Listing 1.21: rada.re session

```

dennis@bigbox ~/tmp % gcc hw.c

dennis@bigbox ~/tmp % radare2 a.out
-- SHALL WE PLAY A GAME?
[0x00400430]> / hello
Searching 5 bytes from 0x00400000 to 0x00601040: 68 65 6c 6c 6f
Searching 5 bytes in [0x400000-0x601040]
hits: 1
0x004005c4 hit0_0 .HHhello, world;0.

[0x00400430]> s 0x004005c4

[0x004005c4]> px
- offset - 0 1 2 3 4 5 6 7 8 9 A B C D E F 0123456789ABCDEF
0x004005c4 6865 6c6c 6f2c 2077 6f72 6c64 0000 0000 hello, world....
0x004005d4 011b 033b 3000 0000 0500 0000 1cfe ffff ...;0.....
0x004005e4 7c00 0000 5cfe ffff 4c00 0000 52ff ffff |...\...L...R...
0x004005f4 a400 0000 6cff ffff c400 0000 dcff ffff ....l.....
0x00400604 0c01 0000 1400 0000 0000 0000 017a 5200 .....zR.
0x00400614 0178 1001 1b0c 0708 9001 0710 1400 0000 .x.....
0x00400624 1c00 0000 08fe ffff 2a00 0000 0000 0000 .....*.....
0x00400634 0000 0000 1400 0000 0000 0000 017a 5200 .....zR.
0x00400644 0178 1001 1b0c 0708 9001 0000 2400 0000 .x.....$.
0x00400654 1c00 0000 98fd ffff 3000 0000 000e 1046 .....0.....F
0x00400664 0e18 4a0f 0b77 0880 003f 1a3b 2a33 2422 ..J..w...?.;*3$"
0x00400674 0000 0000 1c00 0000 4400 0000 a6fe ffff .....D.....
0x00400684 1500 0000 0041 0e10 8602 430d 0650 0c07 ....A...C..P..
0x00400694 0800 0000 4400 0000 6400 0000 a0fe ffff ....D...d.....
0x004006a4 6500 0000 0042 0e10 8f02 420e 188e 0345 e....B...B....E
0x004006b4 0e20 8d04 420e 288c 0548 0e30 8606 480e . .B.(.H.0..H.

[0x004005c4]> oo+
File a.out reopened in read-write mode

[0x004005c4]> w hola, mundo\x00

[0x004005c4]> q

```

```
dennis@bigbox ~/tmp % ./a.out
hola, mundo
```

Here's what's going on: I searched for the "hello" string using the / command, then I set the *cursor* (*seek*, in *rada.re* terms) to that address. Then I want to be sure that this is really that place: *px* dumps bytes there. *oo+* switches *rada.re* to *read-write* mode. *w* writes an ASCII string at the current *seek*. Note the `\00` at the end—this is a zero byte. *q* quits.

## This is a real story of software cracking

An image processing software, when not registered, added watermarks, like "This image was processed by evaluation version of [software name]", across a picture. We tried at random: we found that string in the executable file and put spaces instead of it. Watermarks disappeared. Technically speaking, they continued to appear. With the help of Qt functions, the watermark was still added to the resulting image. But adding spaces didn't alter the image itself...

## Software localization of MS-DOS era

This method was a common way to translate MS-DOS software to Russian language back to 1980's and 1990's. This technique is available even for those who are not aware of machine code and executable file formats. The new string shouldn't be bigger than the old one, because there's a risk of overwriting another value or code there. Russian words and sentences are usually slightly longer than its English counterparts, so that is why *localized* software has a lot of weird acronyms and hardly readable abbreviations.

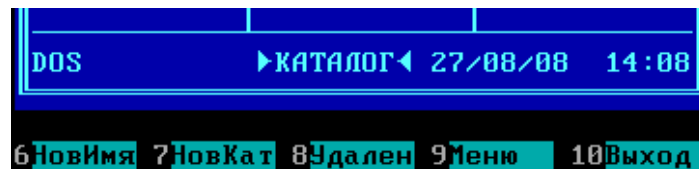

Figure 1.3: Localized Norton Commander 5.51

Perhaps this also happened to other languages during that era, in other countries.

As for Delphi strings, the string's size must also be corrected, if needed.

## 1.5.2 x86-64

### MSVC: x86-64

Let's also try 64-bit MSVC:

Listing 1.22: MSVC 2012 x64

```
$SG2989 DB      'hello, world', 0AH, 00H

main PROC
    sub     rsp, 40
    lea    rcx, OFFSET FLAT:$SG2989
    call   printf
    xor    eax, eax
    add    rsp, 40
    ret    0
main ENDP
```

In x86-64, all registers were extended to 64-bit, and now their names have an R- prefix. In order to use the stack less often (in other words, to access external memory/cache less often), there is a popular way to pass function arguments via registers (*fastcall*) [6.1.3 on page 736](#). I.e., a part of the function's arguments are passed in registers, and the rest—via the stack. In Win64, 4 function arguments are passed in the RCX, RDX, R8, and R9 registers. That is what we see here: a pointer to the string for `printf()` is now passed not in the stack, but rather in the RCX register. The pointers are 64-bit now, so they are passed in the 64-bit registers (which have the R- prefix). However, for backward compatibility, it is still possible to access the 32-bit parts, using the E- prefix. This is how the RAX/EAX/AX/AL register looks like in x86-64:



Byte number:							
7th	6th	5th	4th	3rd	2nd	1st	0th
RAX <sup>x64</sup>							
EAX						AX	
						AH	AL

The `main()` function returns an *int*-typed value, which in C/C++ is still 32-bit, for better backward compatibility and portability, so that is why the EAX register is cleared at the function end (i.e., the 32-bit part of the register) instead of with RAX. There are also 40 bytes allocated in the local stack. This is called the “shadow space”, which we’ll talk about later: [1.14.2 on page 101](#).

## GCC: x86-64

Let’s also try GCC in 64-bit Linux:

Listing 1.23: GCC 4.4.6 x64

```
.string "hello, world\n"
main:
    sub    rsp, 8
    mov    edi, OFFSET FLAT:.LC0 ; "hello, world\n"
    xor    eax, eax ; number of vector registers passed
    call  printf
    xor    eax, eax
    add    rsp, 8
    ret
```

Linux, \*BSD and Mac OS X also use a method to pass function arguments in registers. [Michael Matz, Jan Hubicka, Andreas Jaeger, Mark Mitchell, *System V Application Binary Interface. AMD64 Architecture Processor Supplement*, (2013)] <sup>23</sup>.

The first 6 arguments are passed in the RDI, RSI, RDX, RCX, R8, and R9 registers, and the rest—via the stack.

So the pointer to the string is passed in EDI (the 32-bit part of the register). Why doesn’t it use the 64-bit part, RDI?

It is important to keep in mind that all MOV instructions in 64-bit mode that write something into the lower 32-bit register part also clear the higher 32-bits (as stated in Intel manuals: [12.1.4 on page 1014](#)).

I.e., the MOV EAX, 011223344h writes a value into RAX correctly, since the higher bits will be cleared.

If we open the compiled object file (.o), we can also see all the instructions’ opcodes <sup>24</sup>:

Listing 1.24: GCC 4.4.6 x64

```
.text:0000000004004D0      main  proc near
.text:0000000004004D0 48 83 EC 08      sub    rsp, 8
.text:0000000004004D4 BF E8 05 40 00    mov    edi, offset format ; "hello, world\n"
.text:0000000004004D9 31 C0            xor    eax, eax
.text:0000000004004DB E8 D8 FE FF FF    call  _printf
.text:0000000004004E0 31 C0            xor    eax, eax
.text:0000000004004E2 48 83 C4 08      add    rsp, 8
.text:0000000004004E6 C3              retn
.text:0000000004004E6      main  endp
```

As we can see, the instruction that writes into EDI at 0x4004D4 occupies 5 bytes. The same instruction writing a 64-bit value into RDI occupies 7 bytes. Apparently, GCC is trying to save some space. Besides, it can be sure that the data segment containing the string will not be allocated at the addresses higher than 4GiB.

We also see that the EAX register has been cleared before the `printf()` function call. This is done because according to ABI<sup>25</sup> standard mentioned above, the number of used vector registers is to be passed in EAX in \*NIX systems on x86-64.

<sup>23</sup>Also available as <https://software.intel.com/sites/default/files/article/402129/mpx-linux64-abi.pdf>

<sup>24</sup>This must be enabled in **Options** → **Disassembly** → **Number of opcode bytes**

<sup>25</sup>Application Binary Interface

## Address patching (Win64)

If our example was compiled in MSVC 2013 using /MD switch (meaning a smaller executable due to MSVCR\*.DLL file linkage), the main() function comes first, and can be easily found:

```
C:\tmp\hw2.exe          FWO EDITMODE a64 PE+ 00000000`00000404 Hiew 8.02 (c)SEN
00000400: 4883EC28      sub     rsp,028 ; '('
00000404: 488D0DF51F0000 lea    rcx,[000002400]
0000040B: FF15D7100000  call   q,[0000014E8]
00000411: 33C0         xor     eax,eax
00000413: 4883C428     add     rsp,028 ; '('
00000417: C3         ret    ; ~^~^~^~^~^~^~^~^~^~^~^~^~^~^~^~^~^~^~^
00000418: 4883EC28     sub     rsp,028 ; '('
0000041C: B84D5A0000   mov     eax,00005A4D ; ' ZM'
00000421: 663905D8EFFFFF cmp    [-000000C00],ax
00000428: 7404         jz     0000042E
0000043F: 813850450000 cmp    d,[rax],000004550 ; ' EP'
00000445: 75E3         jnz    0000042A
00000447: B90B020000   mov     ecx,0000020B
0000044C: 66394818     cmp    [rax][018],cx
00000450: 75D8         jnz    0000042A
00000452: 33C9         xor     ecx,ecx
00000454: 83B884000000E cmp    d,[rax][00000084],00E
0000045B: 7609         jbe    00000466
0000045D: 3988F8000000 cmp    [rax][000000F8],ecx
1Help  2    3    4Select 5    6    7    8    9    10   11
```

Figure 1.4: Hiew

As an experiment, we can [increment](#) address by 1:

```

Hiew: hw2.exe
C:\tmp\hw2.exe  FUO ----- a64 PE+.00000001`4000100B Hiew 8.02 (c)SEN
.40001000: 4883EC28      sub     rsp,028 ; '('
.40001004: 488D0DF61F0000     lea    rcx,[00000001`40003001] ;'ello, w
.4000100B: FF15D7100000     call   printf
.40001011: 33C0              xor     eax,eax
.40001013: 4883C428          add     rsp,028 ; '('
.40001017: C3                retn   ; ^^^^
.40001018: 4883EC28          sub     rsp,028 ; '('
.4000101C: B84D5A0000        mov     eax,00005A4D ;' ZM'
.40001021: 663905D8EFFFFFF   cmp     [00000001`40000000],ax
.40001028: 7404              jz     .00000001`4000102E --[2
.4000102A: 33C9              5xor   ecx,ecx
.4000102C: EB38              jmps   .00000001`40001066 --[3
.4000102E: 48630507F0FFFF   2movsxd rax,d,[00000001`4000003C] --[4
.40001035: 488D0DC4EFFFFFF   lea    rcx,[00000001`40000000]
.4000103C: 4803C1            add     rax,rcx
.4000103F: 813850450000     cmp     d,[rax],000004550 ;' EP'
.40001045: 75E3              jnz   .00000001`4000102A --[5
.40001047: B90B020000        mov     ecx,00000020B
.4000104C: 66394818          cmp     [rax][018],cx
.40001050: 75D8              jnz   .00000001`4000102A --[5
.40001052: 33C9              xor     ecx,ecx
.40001054: 83B88400000000E  cmp     d,[rax][000000084],00E
.4000105B: 7609              jbe   .00000001`40001066 --[3
.4000105D: 3988F8000000     cmp     [rax][0000000F8],ecx
1Help  2PutBlk 3Edit  4Mode  5Goto  6Refer  7Search 8Header 9Files 10Quit 11Hem

```

Figure 1.5: Hiew

Hiew shows “ello, world”. And when we run the patched executable, this very string is printed.

### Pick another string from binary image (Linux x64)

The binary file I’ve got when I compile our example using GCC 5.4.0 on Linux x64 box has many other text strings. They are mostly imported function names and library names.

Run objdump to get the contents of all sections of the compiled file:

```

$ objdump -s a.out
a.out:      file format elf64-x86-64
Contents of section .interp:
400238 2f6c6962 36342f6c 642d6c69 6e75782d /lib64/ld-linux-
400248 7838362d 36342e73 6f2e3200      x86-64.so.2.
Contents of section .note.ABI-tag:
400254 04000000 10000000 01000000 474e5500 .....GNU.
400264 00000000 02000000 06000000 20000000 .....
Contents of section .note.gnu.build-id:
400274 04000000 14000000 03000000 474e5500 .....GNU.
400284 fe461178 5bb710b4 bbf2aca8 5ec1ec10 .F.x[.....^...
400294 cf3f7ae4      .?z.
...

```

It’s not a problem to pass address of the text string “/lib64/ld-linux-x86-64.so.2” to printf():

```
#include <stdio.h>

int main()
{
    printf(0x400238);
    return 0;
}
```

It's hard to believe, but this code prints the aforementioned string.

If you would change the address to 0x400260, the "GNU" string would be printed. This address is true for my specific GCC version, GNU toolset, etc. On your system, the executable may be slightly different, and all addresses will also be different. Also, adding/removing code to/from this source code will probably shift all addresses back or forward.

### 1.5.3 ARM

For my experiments with ARM processors, several compilers were used:

- Popular in the embedded area: Keil Release 6/2013.
- Apple Xcode 4.6.3 IDE with the LLVM-GCC 4.2 compiler <sup>26</sup>.
- GCC 4.9 (Linaro) (for ARM64), available as win32-executables at <http://go.yurichev.com/17325>.

32-bit ARM code is used (including Thumb and Thumb-2 modes) in all cases in this book, if not mentioned otherwise. When we talk about 64-bit ARM here, we call it ARM64.

#### Non-optimizing Keil 6/2013 (ARM mode)

Let's start by compiling our example in Keil:

```
armcc.exe --arm --c90 -00 1.c
```

The *armcc* compiler produces assembly listings in Intel-syntax, but it has high-level ARM-processor related macros <sup>27</sup>, but it is more important for us to see the instructions "as is" so let's see the compiled result in [IDA](#).

Listing 1.25: Non-optimizing Keil 6/2013 (ARM mode) [IDA](#)

```
.text:00000000          main
.text:00000000 10 40 2D E9      STMFDP  SP!, {R4,LR}
.text:00000004 1E 0E 8F E2      ADROP  R0, aHelloWorld ; "hello, world"
.text:00000008 15 19 00 EB      BL      __2printf
.text:0000000C 00 00 A0 E3      MOV     R0, #0
.text:00000010 10 80 BD E8      LDMFDP SP!, {R4,PC}

.text:000001EC 68 65 6C 6C+aHelloWorld DCB "hello, world",0 ; DATA XREF: main+4
```

In the example, we can easily see each instruction has a size of 4 bytes. Indeed, we compiled our code for ARM mode, not for Thumb.

The very first instruction, `STMFDP SP!, {R4,LR}`<sup>28</sup>, works as an x86 PUSH instruction, writing the values of two registers (R4 and LR) into the stack.

Indeed, in the output listing from the *armcc* compiler, for the sake of simplification, actually shows the `PUSH {r4,lr}` instruction. But that is not quite precise. The PUSH instruction is only available in Thumb mode. So, to make things less confusing, we're doing this in [IDA](#).

This instruction first [decrements](#) the `SP`<sup>30</sup> so it points to the place in the stack that is free for new entries, then it saves the values of the R4 and LR registers at the address stored in the modified `SP`.

<sup>26</sup>It is indeed so: Apple Xcode 4.6.3 uses open-source GCC as front-end compiler and LLVM code generator

<sup>27</sup>e.g. ARM mode lacks PUSH/POP instructions

<sup>28</sup>`STMFDP`<sup>29</sup>

<sup>30</sup>[stack pointer](#). SP/ESP/RSP in x86/x64. SP in ARM.

This instruction (like the PUSH instruction in Thumb mode) is able to save several register values at once which can be very useful. By the way, this has no equivalent in x86. It can also be noted that the STMFD instruction is a generalization of the PUSH instruction (extending its features), since it can work with any register, not just with SP. In other words, STMFD may be used for storing a set of registers at the specified memory address.

The ADR R0, aHelloWorld instruction adds or subtracts the value in the PC<sup>31</sup> register to the offset where the hello, world string is located. How is the PC register used here, one might ask? This is called “position-independent code”<sup>32</sup>.

Such code can be executed at a non-fixed address in memory. In other words, this is PC-relative addressing. The ADR instruction takes into account the difference between the address of this instruction and the address where the string is located. This difference (offset) is always to be the same, no matter at what address our code is loaded by the OS. That’s why all we need is to add the address of the current instruction (from PC) in order to get the absolute memory address of our C-string.

BL \_\_2printf<sup>33</sup> instruction calls the printf() function. Here’s how this instruction works:

- store the address following the BL instruction (0xC) into the LR;
- then pass the control to printf() by writing its address into the PC register.

When printf() finishes its execution it must have information about where it needs to return the control to. That’s why each function passes control to the address stored in the LR register.

That is a difference between “pure” RISC-processors like ARM and CISC<sup>34</sup>-processors like x86, where the return address is usually stored on the stack. Read more about this in next section ( 1.9 on page 30).

By the way, an absolute 32-bit address or offset cannot be encoded in the 32-bit BL instruction because it only has space for 24 bits. As we may recall, all ARM-mode instructions have a size of 4 bytes (32 bits). Hence, they can only be located on 4-byte boundary addresses. This implies that the last 2 bits of the instruction address (which are always zero bits) may be omitted. In summary, we have 26 bits for offset encoding. This is enough to encode  $current\_PC \pm \approx 32M$ .

Next, the MOV R0, #0<sup>35</sup> instruction just writes 0 into the R0 register. That’s because our C-function returns 0 and the return value is to be placed in the R0 register.

The last instruction LDMFD SP!, R4, PC<sup>36</sup>. It loads values from the stack (or any other memory place) in order to save them into R4 and PC, and increments the stack pointer SP. It works like POP here.

N.B. The very first instruction STMFD saved the R4 and LR registers pair on the stack, but R4 and PC are restored during the LDMFD execution.

As we already know, the address of the place where each function must return control to is usually saved in the LR register. The very first instruction saves its value in the stack because the same register will be used by our main() function when calling printf(). In the function’s end, this value can be written directly to the PC register, thus passing control to where our function has been called.

Since main() is usually the primary function in C/C++, the control will be returned to the OS loader or to a point in a CRT, or something like that.

All that allows omitting the BX LR instruction at the end of the function.

DCB is an assembly language directive defining an array of bytes or ASCII strings, akin to the DB directive in the x86-assembly language.

## Non-optimizing Keil 6/2013 (Thumb mode)

Let’s compile the same example using Keil in Thumb mode:

```
armcc.exe --thumb --c90 -o0 1.c
```

We are getting (in IDA):

<sup>31</sup>Program Counter. IP/EIP/RIP in x86/64. PC in ARM.

<sup>32</sup>Read more about it in relevant section ( 6.4.1 on page 750)

<sup>33</sup>Branch with Link

<sup>34</sup>Complex Instruction Set Computing

<sup>35</sup>Meaning MOVE

<sup>36</sup>LDMFD<sup>37</sup> is an inverse instruction of STMFD

Listing 1.26: Non-optimizing Keil 6/2013 (Thumb mode) + IDA

```

.text:00000000          main
.text:00000000 10 B5      PUSH    {R4,LR}
.text:00000002 C0 A0      ADR     R0, aHelloWorld ; "hello, world"
.text:00000004 06 F0 2E F9    BL      __2printf
.text:00000008 00 20      MOVS   R0, #0
.text:0000000A 10 BD      POP    {R4,PC}

.text:00000304 68 65 6C 6C+aHelloWorld DCB "hello, world",0 ; DATA XREF: main+2

```

We can easily spot the 2-byte (16-bit) opcodes. This is, as was already noted, Thumb. The BL instruction, however, consists of two 16-bit instructions. This is because it is impossible to load an offset for the `printf()` function while using the small space in one 16-bit opcode. Therefore, the first 16-bit instruction loads the higher 10 bits of the offset and the second instruction loads the lower 11 bits of the offset.

As was noted, all instructions in Thumb mode have a size of 2 bytes (or 16 bits). This implies it is impossible for a Thumb-instruction to be at an odd address whatsoever. Given the above, the last address bit may be omitted while encoding instructions.

In summary, the BL Thumb-instruction can encode an address in  $current\_PC \pm \approx 2M$ .

As for the other instructions in the function: PUSH and POP work here just like the described STMFD/LDMFD only the SP register is not mentioned explicitly here. ADR works just like in the previous example. MOVS writes 0 into the R0 register in order to return zero.

### Optimizing Xcode 4.6.3 (LLVM) (ARM mode)

Xcode 4.6.3 without optimization turned on produces a lot of redundant code so we'll study optimized output, where the instruction count is as small as possible, setting the compiler switch `-O3`.

Listing 1.27: Optimizing Xcode 4.6.3 (LLVM) (ARM mode)

```

__text:000028C4          _hello_world
__text:000028C4 80 40 2D E9    STMFD   SP!, {R7,LR}
__text:000028C8 86 06 01 E3    MOV     R0, #0x1686
__text:000028CC 0D 70 A0 E1    MOV     R7, SP
__text:000028D0 00 00 40 E3    MOVT   R0, #0
__text:000028D4 00 00 8F E0    ADD    R0, PC, R0
__text:000028D8 C3 05 00 EB    BL     puts
__text:000028DC 00 00 A0 E3    MOV     R0, #0
__text:000028E0 80 80 BD E8    LDMFD  SP!, {R7,PC}

__cstring:00003F62 48 65 6C 6C+aHelloWorld_0 DCB "Hello world!",0

```

The instructions STMFD and LDMFD are already familiar to us.

The MOV instruction just writes the number `0x1686` into the R0 register. This is the offset pointing to the "Hello world!" string.

The R7 register (as it is standardized in [iOS ABI Function Call Guide, (2010)]<sup>38</sup>) is a frame pointer. More on that below.

The MOVT R0, #0 (MOVE Top) instruction writes 0 into higher 16 bits of the register. The issue here is that the generic MOV instruction in ARM mode may write only the lower 16 bits of the register.

Keep in mind, all instruction opcodes in ARM mode are limited in size to 32 bits. Of course, this limitation is not related to moving data between registers. That's why an additional instruction MOVT exists for writing into the higher bits (from 16 to 31 inclusive). Its usage here, however, is redundant because the MOV R0, #0x1686 instruction above cleared the higher part of the register. This is supposedly a shortcoming of the compiler.

The ADD R0, PC, R0 instruction adds the value in the PC to the value in the R0, to calculate the absolute address of the "Hello world!" string. As we already know, it is "position-independent code" so this correction is essential here.

The BL instruction calls the `puts()` function instead of `printf()`.

<sup>38</sup>Also available as <http://go.yurichev.com/17276>

LLVM has replaced the first `printf()` call with `puts()`. Indeed: `printf()` with a sole argument is almost analogous to `puts()`.

*Almost*, because the two functions are producing the same result only in case the string does not contain printf format identifiers starting with `%`. In case it does, the effect of these two functions would be different <sup>39</sup>.

Why did the compiler replace the `printf()` with `puts()`? Presumably because `puts()` is faster <sup>40</sup>.

Because it just passes characters to `stdout` without comparing every one of them with the `%` symbol.

Next, we see the familiar `MOV R0, #0` instruction intended to set the `R0` register to 0.

### Optimizing Xcode 4.6.3 (LLVM) (Thumb-2 mode)

By default Xcode 4.6.3 generates code for Thumb-2 in this manner:

Listing 1.28: Optimizing Xcode 4.6.3 (LLVM) (Thumb-2 mode)

```
__text:00002B6C          _hello_world
__text:00002B6C  80 B5          PUSH          {R7,LR}
__text:00002B6E  41 F2 D8 30    MOVW         R0, #0x13D8
__text:00002B72  6F 46          MOV          R7, SP
__text:00002B74  C0 F2 00 00    MOVT.W      R0, #0
__text:00002B78  78 44          ADD         R0, PC
__text:00002B7A  01 F0 38 EA    BLX         _puts
__text:00002B7E  00 20          MOVS        R0, #0
__text:00002B80  80 BD          POP         {R7,PC}

...

__cstring:00003E70  48 65 6C 6C 6F 20+aHelloWorld  DCB "Hello world!",0xA,0
```

The `BL` and `BLX` instructions in Thumb mode, as we recall, are encoded as a pair of 16-bit instructions. In Thumb-2 these *surrogate* opcodes are extended in such a way so that new instructions may be encoded here as 32-bit instructions.

That is obvious considering that the opcodes of the Thumb-2 instructions always begin with `0xFx` or `0xEx`.

But in the [IDA](#) listing the opcode bytes are swapped because for ARM processor the instructions are encoded as follows: last byte comes first and after that comes the first one (for Thumb and Thumb-2 modes) or for instructions in ARM mode the fourth byte comes first, then the third, then the second and finally the first (due to different [endianness](#)).

So that is how bytes are located in IDA listings:

- for ARM and ARM64 modes: 4-3-2-1;
- for Thumb mode: 2-1;
- for 16-bit instructions pair in Thumb-2 mode: 2-1-4-3.

So as we can see, the `MOVW`, `MOVT.W` and `BLX` instructions begin with `0xFx`.

One of the Thumb-2 instructions is `MOVW R0, #0x13D8` —it stores a 16-bit value into the lower part of the `R0` register, clearing the higher bits.

Also, `MOVT.W R0, #0` works just like `MOVT` from the previous example only it works in Thumb-2.

Among the other differences, the `BLX` instruction is used in this case instead of the `BL`.

The difference is that, besides saving the [RA](#)<sup>41</sup> in the `LR` register and passing control to the `puts()` function, the processor is also switching from Thumb/Thumb-2 mode to ARM mode (or back).

This instruction is placed here since the instruction to which control is passed looks like (it is encoded in ARM mode):

<sup>39</sup>It has also to be noted the `puts()` does not require a `\n` new line symbol at the end of a string, so we do not see it here.

<sup>40</sup>[ciselant.de/projects/gcc\\_printf/gcc\\_printf.html](http://ciselant.de/projects/gcc_printf/gcc_printf.html)

<sup>41</sup>Return Address

```
__symbolstub1:00003FEC _puts ; CODE XREF: _hello_world+E
__symbolstub1:00003FEC 44 F0 9F E5 LDR PC, =__imp__puts
```

This is essentially a jump to the place where the address of `puts()` is written in the imports' section. So, the observant reader may ask: why not call `puts()` right at the point in the code where it is needed? Because it is not very space-efficient.

Almost any program uses external dynamic libraries (like DLL in Windows, `.so` in \*NIX or `.dylib` in Mac OS X). The dynamic libraries contain frequently used library functions, including the standard C-function `puts()`.

In an executable binary file (Windows PE `.exe`, ELF or Mach-O) an import section is present. This is a list of symbols (functions or global variables) imported from external modules along with the names of the modules themselves.

The OS loader loads all modules it needs and, while enumerating import symbols in the primary module, determines the correct addresses of each symbol.

In our case, `__imp__puts` is a 32-bit variable used by the OS loader to store the correct address of the function in an external library. Then the LDR instruction just reads the 32-bit value from this variable and writes it into the PC register, passing control to it.

So, in order to reduce the time the OS loader needs for completing this procedure, it is good idea to write the address of each symbol only once, to a dedicated place.

Besides, as we have already figured out, it is impossible to load a 32-bit value into a register while using only one instruction without a memory access.

Therefore, the optimal solution is to allocate a separate function working in ARM mode with the sole goal of passing control to the dynamic library and then to jump to this short one-instruction function (the so-called [thunk function](#)) from the Thumb-code.

By the way, in the previous example (compiled for ARM mode) the control is passed by the BL to the same [thunk function](#). The processor mode, however, is not being switched (hence the absence of an "X" in the instruction mnemonic).

## More about thunk-functions

Thunk-functions are hard to understand, apparently, because of a misnomer. The simplest way to understand it as adaptors or convertors of one type of jack to another. For example, an adaptor allowing the insertion of a British power plug into an American wall socket, or vice-versa. Thunk functions are also sometimes called *wrappers*.

Here are a couple more descriptions of these functions:

"A piece of coding which provides an address:", according to P. Z. Ingerman, who invented thunks in 1961 as a way of binding actual parameters to their formal definitions in Algol-60 procedure calls. If a procedure is called with an expression in the place of a formal parameter, the compiler generates a thunk which computes the expression and leaves the address of the result in some standard location.

...  
Microsoft and IBM have both defined, in their Intel-based systems, a "16-bit environment" (with bletcherous segment registers and 64K address limits) and a "32-bit environment" (with flat addressing and semi-real memory management). The two environments can both be running on the same computer and OS (thanks to what is called, in the Microsoft world, WOW which stands for Windows On Windows). MS and IBM have both decided that the process of getting from 16- to 32-bit and vice versa is called a "thunk"; for Windows 95, there is even a tool, THUNK.EXE, called a "thunk compiler".

( [The Jargon File](#) )

Another example we can find in LAPACK library—a "Linear Algebra PACKage" written in FORTRAN. C/C++ developers also want to use LAPACK, but it's insane to rewrite it to C/C++ and then maintain several versions. So there are short C functions callable from C/C++ environment, which are, in turn, call FORTRAN functions, and do almost anything else:



```
double Blas_Dot_Prod(const LaVectorDouble &dx, const LaVectorDouble &dy)
{
    assert(dx.size()==dy.size());
    integer n = dx.size();
    integer incx = dx.inc(), incy = dy.inc();

    return F77NAME(ddot>(&n, &dx(0), &incx, &dy(0), &incy);
}
```

Also, functions like that are called “wrappers”.

## ARM64

### GCC

Let’s compile the example using GCC 4.8.1 in ARM64:

Listing 1.29: Non-optimizing GCC 4.8.1 + objdump

```
1 000000000400590 <main>:
2 400590: a9bf7bfd stp x29, x30, [sp,#-16]!
3 400594: 910003fd mov x29, sp
4 400598: 90000000 adrp x0, 400000 <_init-0x3b8>
5 40059c: 91192000 add x0, x0, #0x648
6 4005a0: 97ffffa0 bl 400420 <puts@plt>
7 4005a4: 52800000 mov w0, #0x0 // #0
8 4005a8: a8c17bfd ldp x29, x30, [sp],#16
9 4005ac: d65f03c0 ret
10
11 ...
12
13 Contents of section .rodata:
14 400640 01000200 00000000 48656c6c 6f210a00 .....Hello!..
```

There are no Thumb and Thumb-2 modes in ARM64, only ARM, so there are 32-bit instructions only. The Register count is doubled: [2.4 on page 1042](#). 64-bit registers have X- prefixes, while its 32-bit parts—W-

The STP instruction (*Store Pair*) saves two registers in the stack simultaneously: X29 and X30.

Of course, this instruction is able to save this pair at an arbitrary place in memory, but the SP register is specified here, so the pair is saved in the stack.

ARM64 registers are 64-bit ones, each has a size of 8 bytes, so one needs 16 bytes for saving two registers.

The exclamation mark (“!”) after the operand means that 16 is to be subtracted from SP first, and only then are values from register pair to be written into the stack. This is also called *pre-index*. About the difference between *post-index* and *pre-index* read here: [1.39.2 on page 440](#).

Hence, in terms of the more familiar x86, the first instruction is just an analogue to a pair of PUSH X29 and PUSH X30. X29 is used as FP<sup>42</sup> in ARM64, and X30 as LR, so that’s why they are saved in the function prologue and restored in the function epilogue.

The second instruction copies SP in X29 (or FP). This is made so to set up the function stack frame.

ADRP and ADD instructions are used to fill the address of the string “Hello!” into the X0 register, because the first function argument is passed in this register. There are no instructions, whatsoever, in ARM that can store a large number into a register (because the instruction length is limited to 4 bytes, read more about it here: [1.39.3 on page 441](#)). So several instructions must be utilized. The first instruction (ADRP) writes the address of the 4KiB page, where the string is located, into X0, and the second one (ADD) just adds the remainder to the address. More about that in: [1.39.4 on page 443](#).

0x400000 + 0x648 = 0x400648, and we see our “Hello!” C-string in the .rodata data segment at this address.

puts() is called afterwards using the BL instruction. This was already discussed: [1.5.3 on page 20](#).

MOV writes 0 into W0. W0 is the lower 32 bits of the 64-bit X0 register:

<sup>42</sup>Frame Pointer

High 32-bit part	low 32-bit part
X0	
	W0

The function result is returned via X0 and main() returns 0, so that's how the return result is prepared. But why use the 32-bit part?

Because the *int* data type in ARM64, just like in x86-64, is still 32-bit, for better compatibility.

So if a function returns a 32-bit *int*, only the lower 32 bits of X0 register have to be filled.

In order to verify this, let's change this example slightly and recompile it. Now main() returns a 64-bit value:

Listing 1.30: main() returning a value of uint64\_t type

```
#include <stdio.h>
#include <stdint.h>

uint64_t main()
{
    printf ("Hello!\n");
    return 0;
}
```

The result is the same, but that's how MOV at that line looks like now:

Listing 1.31: Non-optimizing GCC 4.8.1 + objdump

```
4005a4:    d2800000    mov     x0, #0x0    // #0
```

LDP (*Load Pair*) then restores the X29 and X30 registers.

There is no exclamation mark after the instruction: this implies that the values are first loaded from the stack, and only then is *SP* increased by 16. This is called *post-index*.

A new instruction appeared in ARM64: RET. It works just as BX LR, only a special *hint* bit is added, informing the CPU that this is a return from a function, not just another jump instruction, so it can execute it more optimally.

Due to the simplicity of the function, optimizing GCC generates the very same code.

## 1.5.4 MIPS

### A word about the “global pointer”

One important MIPS concept is the “global pointer”. As we may already know, each MIPS instruction has a size of 32 bits, so it's impossible to embed a 32-bit address into one instruction: a pair has to be used for this (like GCC did in our example for the text string address loading). It's possible, however, to load data from the address in the range of  $register - 32768 \dots register + 32767$  using one single instruction (because 16 bits of signed offset could be encoded in a single instruction). So we can allocate some register for this purpose and also allocate a 64KiB area of most used data. This allocated register is called a “global pointer” and it points to the middle of the 64KiB area. This area usually contains global variables and addresses of imported functions like printf(), because the GCC developers decided that getting the address of some function must be as fast as a single instruction execution instead of two. In an ELF file this 64KiB area is located partly in sections .sbss (“small BSS<sup>43</sup>”) for uninitialized data and .sdata (“small data”) for initialized data. This implies that the programmer may choose what data he/she wants to be accessed fast and place it into .sdata/.sbss. Some old-school programmers may recall the MS-DOS memory model [11.6 on page 1000](#) or the MS-DOS memory managers like XMS/EMS where all memory was divided in 64KiB blocks.

This concept is not unique to MIPS. At least PowerPC uses this technique as well.

<sup>43</sup>Block Started by Symbol

## Optimizing GCC

Let's consider the following example, which illustrates the "global pointer" concept.

Listing 1.32: Optimizing GCC 4.4.5 (assembly output)

```
1 $LC0:
2 ; \000 is zero byte in octal base:
3   .ascii "Hello, world!\012\000"
4 main:
5 ; function prologue.
6 ; set the GP:
7     lui    $28,%hi(__gnu_local_gp)
8     addiu  $sp,$sp,-32
9     addiu  $28,$28,%lo(__gnu_local_gp)
10 ; save the RA to the local stack:
11     sw    $31,28($sp)
12 ; load the address of the puts() function from the GP to $25:
13     lw    $25,%call16(puts)($28)
14 ; load the address of the text string to $4 ($a0):
15     lui   $4,%hi($LC0)
16 ; jump to puts(), saving the return address in the link register:
17     jalr  $25
18     addiu $4,$4,%lo($LC0) ; branch delay slot
19 ; restore the RA:
20     lw    $31,28($sp)
21 ; copy 0 from $zero to $v0:
22     move  $2,$0
23 ; return by jumping to the RA:
24     j     $31
25 ; function epilogue:
26     addiu $sp,$sp,32 ; branch delay slot + free local stack
```

As we see, the \$GP register is set in the function prologue to point to the middle of this area. The RA register is also saved in the local stack. puts() is also used here instead of printf(). The address of the puts() function is loaded into \$25 using LW the instruction ("Load Word"). Then the address of the text string is loaded to \$4 using LUI ("Load Upper Immediate") and ADDIU ("Add Immediate Unsigned Word") instruction pair. LUI sets the high 16 bits of the register (hence "upper" word in instruction name) and ADDIU adds the lower 16 bits of the address.

ADDIU follows JALR (haven't you forgot *branch delay slots* yet?). The register \$4 is also called \$A0, which is used for passing the first function argument <sup>44</sup>.

JALR ("Jump and Link Register") jumps to the address stored in the \$25 register (address of puts()) while saving the address of the next instruction (LW) in RA. This is very similar to ARM. Oh, and one important thing is that the address saved in RA is not the address of the next instruction (because it's in a *delay slot* and is executed before the jump instruction), but the address of the instruction after the next one (after the *delay slot*). Hence, PC+8 is written to RA during the execution of JALR, in our case, this is the address of the LW instruction next to ADDIU.

LW ("Load Word") at line 20 restores RA from the local stack (this instruction is actually part of the function epilogue).

MOVE at line 22 copies the value from the \$0 (\$ZERO) register to \$2 (\$V0).

MIPS has a *constant* register, which always holds zero. Apparently, the MIPS developers came up with the idea that zero is in fact the busiest constant in the computer programming, so let's just use the \$0 register every time zero is needed.

Another interesting fact is that MIPS lacks an instruction that transfers data between registers. In fact, MOVE DST, SRC is ADD DST, SRC, \$ZERO ( $DST = SRC + 0$ ), which does the same. Apparently, the MIPS developers wanted to have a compact opcode table. This does not mean an actual addition happens at each MOVE instruction. Most likely, the CPU optimizes these pseudo instructions and the ALU<sup>45</sup> is never used.

J at line 24 jumps to the address in RA, which is effectively performing a return from the function. ADDIU after J is in fact executed before J (remember *branch delay slots*?) and is part of the function epilogue. Here is also a listing generated by IDA. Each register here has its own pseudo name:

<sup>44</sup>The MIPS registers table is available in appendix .3.1 on page 1043

<sup>45</sup>Arithmetic Logic Unit

Listing 1.33: Optimizing GCC 4.4.5 (IDA)

```

1  .text:00000000 main:
2  .text:00000000
3  .text:00000000 var_10      = -0x10
4  .text:00000000 var_4      = -4
5  .text:00000000
6  ; function prologue.
7  ; set the GP:
8  .text:00000000          lui    $gp, (__gnu_local_gp >> 16)
9  .text:00000004          addiu   $sp, -0x20
10 .text:00000008          la     $gp, (__gnu_local_gp & 0xFFFF)
11 ; save the RA to the local stack:
12 .text:0000000C          sw     $ra, 0x20+var_4($sp)
13 ; save the GP to the local stack:
14 ; for some reason, this instruction is missing in the GCC assembly output:
15 .text:00000010          sw     $gp, 0x20+var_10($sp)
16 ; load the address of the puts() function from the GP to $t9:
17 .text:00000014          lw     $t9, (puts & 0xFFFF)($gp)
18 ; form the address of the text string in $a0:
19 .text:00000018          lui    $a0, ($LC0 >> 16) # "Hello, world!"
20 ; jump to puts(), saving the return address in the link register:
21 .text:0000001C          jalr  $t9
22 .text:00000020          la     $a0, ($LC0 & 0xFFFF) # "Hello, world!"
23 ; restore the RA:
24 .text:00000024          lw     $ra, 0x20+var_4($sp)
25 ; copy 0 from $zero to $v0:
26 .text:00000028          move  $v0, $zero
27 ; return by jumping to the RA:
28 .text:0000002C          jr    $ra
29 ; function epilogue:
30 .text:00000030          addiu  $sp, 0x20

```

The instruction at line 15 saves the GP value into the local stack, and this instruction is missing mysteriously from the GCC output listing, maybe by a GCC error<sup>46</sup>. The GP value has to be saved indeed, because each function can use its own 64KiB data window. The register containing the puts() address is called \$T9, because registers prefixed with T- are called “temporaries” and their contents may not be preserved.

## Non-optimizing GCC

Non-optimizing GCC is more verbose.

Listing 1.34: Non-optimizing GCC 4.4.5 (assembly output)

```

1  $LC0:
2  .ascii "Hello, world!\012\000"
3  main:
4  ; function prologue.
5  ; save the RA ($31) and FP in the stack:
6  addiu  $sp,$sp,-32
7  sw     $31,28($sp)
8  sw     $fp,24($sp)
9  ; set the FP (stack frame pointer):
10 move  $fp,$sp
11 ; set the GP:
12 lui    $28,%hi(__gnu_local_gp)
13 addiu  $28,$28,%lo(__gnu_local_gp)
14 ; load the address of the text string:
15 lui    $2,%hi($LC0)
16 addiu  $4,$2,%lo($LC0)
17 ; load the address of puts() using the GP:
18 lw     $2,%call16(puts)($28)
19 nop
20 ; call puts():
21 move  $25,$2
22 jalr  $25
23 nop ; branch delay slot
24

```

<sup>46</sup>Apparently, functions generating listings are not so critical to GCC users, so some unfixed cosmetic bugs may still exist.

```

25 ; restore the GP from the local stack:
26     lw     $28,16($fp)
27 ; set register $2 ($V0) to zero:
28     move   $2,$0
29 ; function epilogue.
30 ; restore the SP:
31     move   $sp,$fp
32 ; restore the RA:
33     lw     $31,28($sp)
34 ; restore the FP:
35     lw     $fp,24($sp)
36     addiu  $sp,$sp,32
37 ; jump to the RA:
38     j      $31
39     nop   ; branch delay slot

```

We see here that register FP is used as a pointer to the stack frame. We also see 3 [NOPs](#). The second and third of which follow the branch instructions. Perhaps the GCC compiler always adds [NOPs](#) (because of *branch delay slots*) after branch instructions and then, if optimization is turned on, maybe eliminates them. So in this case they are left here.

Here is also [IDA](#) listing:

Listing 1.35: Non-optimizing GCC 4.4.5 ([IDA](#))

```

1  .text:00000000 main:
2  .text:00000000
3  .text:00000000 var_10      = -0x10
4  .text:00000000 var_8      = -8
5  .text:00000000 var_4      = -4
6  .text:00000000
7  ; function prologue.
8  ; save the RA and FP in the stack:
9  .text:00000000          addiu   $sp, -0x20
10 .text:00000004          sw      $ra, 0x20+var_4($sp)
11 .text:00000008          sw      $fp, 0x20+var_8($sp)
12 ; set the FP (stack frame pointer):
13 .text:0000000C          move   $fp, $sp
14 ; set the GP:
15 .text:00000010          la     $gp, __gnu_local_gp
16 .text:00000018          sw      $gp, 0x20+var_10($sp)
17 ; load the address of the text string:
18 .text:0000001C          lui    $v0, (aHelloWorld >> 16) # "Hello, world!"
19 .text:00000020          addiu  $a0, $v0, (aHelloWorld & 0xFFFF) # "Hello, world!"
20 ; load the address of puts() using the GP:
21 .text:00000024          lw     $v0, (puts & 0xFFFF)($gp)
22 .text:00000028          or     $at, $zero ; NOP
23 ; call puts():
24 .text:0000002C          move   $t9, $v0
25 .text:00000030          jalr  $t9
26 .text:00000034          or     $at, $zero ; NOP
27 ; restore the GP from local stack:
28 .text:00000038          lw     $gp, 0x20+var_10($fp)
29 ; set register $2 ($V0) to zero:
30 .text:0000003C          move   $v0, $zero
31 ; function epilogue.
32 ; restore the SP:
33 .text:00000040          move   $sp, $fp
34 ; restore the RA:
35 .text:00000044          lw     $ra, 0x20+var_4($sp)
36 ; restore the FP:
37 .text:00000048          lw     $fp, 0x20+var_8($sp)
38 .text:0000004C          addiu  $sp, 0x20
39 ; jump to the RA:
40 .text:00000050          jr    $ra
41 .text:00000054          or     $at, $zero ; NOP

```

Interestingly, [IDA](#) recognized the LUI/ADDIU instructions pair and coalesced them into one LA (“Load Address”) pseudo instruction at line 15. We may also see that this pseudo instruction has a size of 8 bytes!

This is a pseudo instruction (or *macro*) because it's not a real MIPS instruction, but rather a handy name for an instruction pair.

Another thing is that [IDA](#) doesn't recognize [NOP](#) instructions, so here they are at lines 22, 26 and 41. It is OR \$AT, \$ZERO. Essentially, this instruction applies the OR operation to the contents of the \$AT register with zero, which is, of course, an idle instruction. MIPS, like many other [ISAs](#), doesn't have a separate [NOP](#) instruction.

### Role of the stack frame in this example

The address of the text string is passed in the register. Why setup a local stack anyway? The reason for this lies in the fact that the values of registers [RA](#) and [GP](#) have to be saved somewhere (because `printf()` is called), and the local stack is used for this purpose. If this was a [leaf function](#), it would have been possible to get rid of the function prologue and epilogue, for example: [1.4.3 on page 8](#).

### Optimizing GCC: load it into GDB

Listing 1.36: sample GDB session

```
root@debian-mips:~# gcc hw.c -O3 -o hw

root@debian-mips:~# gdb hw
GNU gdb (GDB) 7.0.1-debian
...
Reading symbols from /root/hw...(no debugging symbols found)...done.
(gdb) b main
Breakpoint 1 at 0x400654
(gdb) run
Starting program: /root/hw

Breakpoint 1, 0x00400654 in main ()
(gdb) set step-mode on
(gdb) disas
Dump of assembler code for function main:
0x00400640 <main+0>:   lui    gp,0x42
0x00400644 <main+4>:   addiu  sp,sp,-32
0x00400648 <main+8>:   addiu  gp,gp,-30624
0x0040064c <main+12>:  sw     ra,28(sp)
0x00400650 <main+16>:  sw     gp,16(sp)
0x00400654 <main+20>:  lw     t9,-32716(gp)
0x00400658 <main+24>:  lui    a0,0x40
0x0040065c <main+28>:  jalr   t9
0x00400660 <main+32>:  addiu  a0,a0,2080
0x00400664 <main+36>:  lw     ra,28(sp)
0x00400668 <main+40>:  move   v0,zero
0x0040066c <main+44>:  jr     ra
0x00400670 <main+48>:  addiu  sp,sp,32
End of assembler dump.
(gdb) s
0x00400658 in main ()
(gdb) s
0x0040065c in main ()
(gdb) s
0x2ab2de60 in printf () from /lib/libc.so.6
(gdb) x/s $a0
0x400820:      "hello, world"
(gdb)
```

### 1.5.5 Conclusion

The main difference between x86/ARM and x64/ARM64 code is that the pointer to the string is now 64-bits in length. Indeed, modern [CPUs](#) are now 64-bit due to both the reduced cost of memory and the greater demand for it by modern applications. We can add much more memory to our computers than 32-bit pointers are able to address. As such, all pointers are now 64-bit.

## 1.5.6 Exercises

- <http://challenges.re/48>
- <http://challenges.re/49>

## 1.6 Function prologue and epilogue

A function prologue is a sequence of instructions at the start of a function. It often looks something like the following code fragment:

```
push    ebp
mov     ebp, esp
sub     esp, X
```

What these instructions do: save the value of the EBP register on the stack, set the value of the EBP register to the value of the ESP and then allocate space on the stack for local variables.

The value in the EBP stays the same over the period of the function execution and is to be used for local variables and arguments access. For the same purpose one can use ESP, but since it changes over time this approach is not too convenient.

The function epilogue frees the allocated space in the stack, returns the value in the EBP register back to its initial state and returns the control flow to the [caller](#):

```
mov     esp, ebp
pop     ebp
ret     0
```

Function prologues and epilogues are usually detected in disassemblers for function delimitation.

### 1.6.1 Recursion

Epilogues and prologues can negatively affect the recursion performance.

More about recursion in this book: [3.7.3 on page 485](#).

## 1.7 An Empty Function: `redux`

Let's back to the empty function example [1.3 on page 5](#). Now that we know about function prologue and epilogue, this is an empty function [1.1 on page 5](#) compiled by non-optimizing GCC:

Listing 1.37: Non-optimizing GCC 8.2 x64 (assembly output)

```
f:
    push    rbp
    mov     rbp, rsp
    nop
    pop     rbp
    ret
```

It's RET, but function prologue and epilogue, probably, wasn't optimized and left as is. NOP is seems another compiler artefact. Anyway, the only effective instruction here is RET. All other instructions can be removed (or optimized).

## 1.8 Returning Values: `redux`

Again, when we know about function prologue and epilogue, let's recompile an example returning a value ([1.4 on page 7](#), [1.8 on page 7](#)) using non-optimizing GCC:

Listing 1.38: Non-optimizing GCC 8.2 x64 (assembly output)

```
f:
    push    rbp
    mov     rbp, rsp
    mov     eax, 123
    pop     rbp
    ret
```

Effective instructions here are MOV and RET, others are - prologue and epilogue.

## 1.9 Stack

The stack is one of the most fundamental data structures in computer science <sup>47</sup>. AKA<sup>48</sup> LIFO<sup>49</sup>.

Technically, it is just a block of memory in process memory along with the ESP or RSP register in x86 or x64, or the SP register in ARM, as a pointer within that block.

The most frequently used stack access instructions are PUSH and POP (in both x86 and ARM Thumb-mode). PUSH subtracts from ESP/RSP/SP 4 in 32-bit mode (or 8 in 64-bit mode) and then writes the contents of its sole operand to the memory address pointed by ESP/RSP/SP.

POP is the reverse operation: retrieve the data from the memory location that SP points to, load it into the instruction operand (often a register) and then add 4 (or 8) to the stack pointer.

After stack allocation, the stack pointer points at the bottom of the stack. PUSH decreases the stack pointer and POP increases it. The bottom of the stack is actually at the beginning of the memory allocated for the stack block. It seems strange, but that's the way it is.

ARM supports both descending and ascending stacks.

For example the STMFD/LDMFD, STMED<sup>50</sup>/LDMED<sup>51</sup> instructions are intended to deal with a descending stack (grows downwards, starting with a high address and progressing to a lower one). The STMFA<sup>52</sup>/LDMFA<sup>53</sup>, STMEA<sup>54</sup>/LDMEA<sup>55</sup> instructions are intended to deal with an ascending stack (grows upwards, starting from a low address and progressing to a higher one).

### 1.9.1 Why does the stack grow backwards?

Intuitively, we might think that the stack grows upwards, i.e. towards higher addresses, like any other data structure.

The reason that the stack grows backward is probably historical. When the computers were big and occupied a whole room, it was easy to divide memory into two parts, one for the heap and one for the stack. Of course, it was unknown how big the heap and the stack would be during program execution, so this solution was the simplest possible.

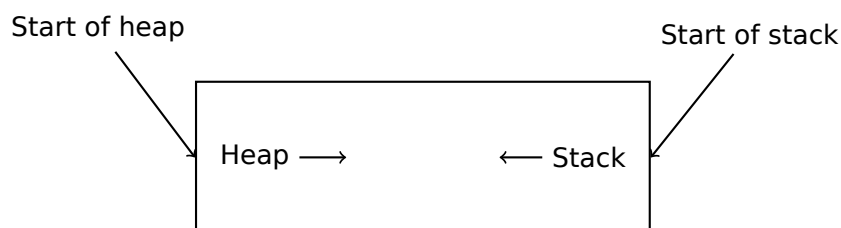

In [D. M. Ritchie and K. Thompson, *The UNIX Time Sharing System*, (1974)]<sup>56</sup> we can read:

<sup>47</sup> [wikipedia.org/wiki/Call\\_stack](http://wikipedia.org/wiki/Call_stack)

<sup>48</sup> Also Known As

<sup>49</sup> Last In First Out

<sup>50</sup> Store Multiple Empty Descending (ARM instruction)

<sup>51</sup> Load Multiple Empty Descending (ARM instruction)

<sup>52</sup> Store Multiple Full Ascending (ARM instruction)

<sup>53</sup> Load Multiple Full Ascending (ARM instruction)

<sup>54</sup> Store Multiple Empty Ascending (ARM instruction)

<sup>55</sup> Load Multiple Empty Ascending (ARM instruction)

<sup>56</sup> Also available as <http://go.yurichev.com/17270>



The user-core part of an image is divided into three logical segments. The program text segment begins at location 0 in the virtual address space. During execution, this segment is write-protected and a single copy of it is shared among all processes executing the same program. At the first 8K byte boundary above the program text segment in the virtual address space begins a nonshared, writable data segment, the size of which may be extended by a system call. Starting at the highest address in the virtual address space is a stack segment, which automatically grows downward as the hardware's stack pointer fluctuates.

This reminds us how some students write two lecture notes using only one notebook: notes for the first lecture are written as usual, and notes for the second one are written from the end of notebook, by flipping it. Notes may meet each other somewhere in between, in case of lack of free space.

## 1.9.2 What is the stack used for?

### Save the function's return address

#### x86

When calling another function with a CALL instruction, the address of the point exactly after the CALL instruction is saved to the stack and then an unconditional jump to the address in the CALL operand is executed.

The CALL instruction is equivalent to a PUSH `address_after_call` / JMP operand instruction pair.

RET fetches a value from the stack and jumps to it—that is equivalent to a POP `tmp` / JMP `tmp` instruction pair.

Overflowing the stack is straightforward. Just run eternal recursion:

```
void f()
{
    f();
};
```

MSVC 2008 reports the problem:

```
c:\tmp6>cl ss.cpp /Fass.asm
Microsoft (R) 32-bit C/C++ Optimizing Compiler Version 15.00.21022.08 for 80x86
Copyright (C) Microsoft Corporation. All rights reserved.

ss.cpp
c:\tmp6\ss.cpp(4) : warning C4717: 'f' : recursive on all control paths, function will cause
  ↪ runtime stack overflow
```

...but generates the right code anyway:

```
?f@@YAXXZ PROC                ; f
; Line 2
    push    ebp
    mov     ebp, esp
; Line 3
    call    ?f@@YAXXZ          ; f
; Line 4
    pop     ebp
    ret     0
?f@@YAXXZ ENDP                ; f
```

...Also if we turn on the compiler optimization (`/Ox` option) the optimized code will not overflow the stack and will work *correctly*<sup>57</sup> instead:

<sup>57</sup>irony here

```
?f@@YAXXZ PROC                ; f
; Line 2
$LL3@f:
; Line 3
        jmp     SHORT $LL3@f
?f@@YAXXZ ENDP                ; f
```

GCC 4.4.1 generates similar code in both cases without, however, issuing any warning about the problem.

## ARM

ARM programs also use the stack for saving return addresses, but differently. As mentioned in “Hello, world!” ( 1.5.3 on page 18), the RA is saved to the LR (link register). If one needs, however, to call another function and use the LR register one more time, its value has to be saved. Usually it is saved in the function prologue.

Often, we see instructions like PUSH R4-R7, LR along with this instruction in epilogue POP R4-R7, PC—thus register values to be used in the function are saved in the stack, including LR.

Nevertheless, if a function never calls any other function, in RISC terminology it is called a *leaf function*<sup>58</sup>. As a consequence, leaf functions do not save the LR register (because they don’t modify it). If such function is small and uses a small number of registers, it may not use the stack at all. Thus, it is possible to call leaf functions without using the stack, which can be faster than on older x86 machines because external RAM is not used for the stack<sup>59</sup>. This can be also useful for situations when memory for the stack is not yet allocated or not available.

Some examples of leaf functions: 1.14.3 on page 104, 1.14.3 on page 104, 1.282 on page 316, 1.298 on page 333, 1.28.5 on page 334, 1.192 on page 210, 1.190 on page 208, 1.209 on page 226.

## Passing function arguments

The most popular way to pass parameters in x86 is called “cdecl”:

```
push arg3
push arg2
push arg1
call f
add esp, 12 ; 4*3=12
```

**Callee** functions get their arguments via the stack pointer.

Therefore, this is how the argument values are located in the stack before the execution of the f() function’s very first instruction:

ESP	return address
ESP+4	argument#1, marked in IDA as arg_0
ESP+8	argument#2, marked in IDA as arg_4
ESP+0xC	argument#3, marked in IDA as arg_8
...	...

For more information on other calling conventions see also section ( 6.1 on page 735).

By the way, the **callee** function does not have any information about how many arguments were passed. C functions with a variable number of arguments (like printf()) determine their number using format string specifiers (which begin with the % symbol).

If we write something like:

```
printf("%d %d %d", 1234);
```

<sup>58</sup>[infocenter.arm.com/help/index.jsp?topic=/com.arm.doc.faqs/ka13785.html](http://infocenter.arm.com/help/index.jsp?topic=/com.arm.doc.faqs/ka13785.html)

<sup>59</sup>Some time ago, on PDP-11 and VAX, the CALL instruction (calling other functions) was expensive; up to 50% of execution time might be spent on it, so it was considered that having a big number of small functions is an **anti-pattern** [Eric S. Raymond, *The Art of UNIX Programming*, (2003)Chapter 4, Part II].

printf() will print 1234, and then two random numbers<sup>60</sup>, which were lying next to it in the stack.

That's why it is not very important how we declare the main() function: as main(), main(int argc, char \*argv[]) or main(int argc, char \*argv[], char \*envp[]).

In fact, the CRT-code is calling main() roughly as:

```
push envp
push argv
push argc
call main
...
```

If you declare main() as main() without arguments, they are, nevertheless, still present in the stack, but are not used. If you declare main() as main(int argc, char \*argv[]), you will be able to use first two arguments, and the third will remain "invisible" for your function. Even more, it is possible to declare main(int argc), and it will work.

Another related example: [6.1.10](#).

### Alternative ways of passing arguments

It is worth noting that nothing obliges programmers to pass arguments through the stack. It is not a requirement. One could implement any other method without using the stack at all.

A somewhat popular way among assembly language newbies is to pass arguments via global variables, like:

Listing 1.39: Assembly code

```
...

mov     X, 123
mov     Y, 456
call   do_something

...

X       dd     ?
Y       dd     ?

do_something proc near
; take X
; take Y
; do something
retn
do_something endp
```

But this method has obvious drawback: *do\_something()* function cannot call itself recursively (or via another function), because it has to zap its own arguments. The same story with local variables: if you hold them in global variables, the function couldn't call itself. And this is also not thread-safe<sup>61</sup>. A method to store such information in stack makes this easier—it can hold as many function arguments and/or values, as much space it has.

[Donald E. Knuth, *The Art of Computer Programming*, Volume 1, 3rd ed., (1997), 189] mentions even weirder schemes particularly convenient on IBM System/360.

MS-DOS had a way of passing all function arguments via registers, for example, this is piece of code for ancient 16-bit MS-DOS prints "Hello, world!":

```
mov dx, msg      ; address of message
mov ah, 9        ; 9 means "print string" function
int 21h         ; DOS "syscall"
```

<sup>60</sup>Not random in strict sense, but rather unpredictable: [1.9.4 on page 37](#)

<sup>61</sup>Correctly implemented, each thread would have its own stack with its own arguments/variables.

```

mov ah, 4ch      ; "terminate program" function
int 21h         ; DOS "syscall"

msg db 'Hello, World!\$'

```

This is quite similar to [6.1.3 on page 736](#) method. And also it's very similar to calling syscalls in Linux ([6.3.1 on page 749](#)) and Windows.

If a MS-DOS function is going to return a boolean value (i.e., single bit, usually indicating error state), CF flag was often used.

For example:

```

mov ah, 3ch      ; create file
lea dx, filename
mov cl, 1
int 21h
jc error
mov file_handle, ax
...
error:
...

```

In case of error, CF flag is raised. Otherwise, handle of newly created file is returned via AX.

This method is still used by assembly language programmers. In Windows Research Kernel source code (which is quite similar to Windows 2003) we can find something like this (file *base/ntos/ke/i386/cpu.asm*):

```

        public  Get386Stepping
Get386Stepping  proc

        call    MultiplyTest          ; Perform multiplication test
        jnc     short G3s00           ; if nc, muttest is ok
        mov     ax, 0
        ret

G3s00:
        call    Check386B0            ; Check for B0 stepping
        jnc     short G3s05           ; if nc, it's B1/later
        mov     ax, 100h              ; It is B0/earlier stepping
        ret

G3s05:
        call    Check386D1            ; Check for D1 stepping
        jc      short G3s10           ; if c, it is NOT D1
        mov     ax, 301h              ; It is D1/later stepping
        ret

G3s10:
        mov     ax, 101h              ; assume it is B1 stepping
        ret

        ...

MultiplyTest  proc

mlt00:  xor     cx,cx                  ; 64K times is a nice round number
        push   cx
        call   Multiply              ; does this chip's multiply work?
        pop    cx
        jc     short mltx             ; if c, No, exit
        loop   mlt00                 ; if nc, YEs, loop to try again
        clc

mltx:
        ret

MultiplyTest  endp

```

## Local variable storage

A function could allocate space in the stack for its local variables just by decreasing the [stack pointer](#) towards the stack bottom.

Hence, it's very fast, no matter how many local variables are defined. It is also not a requirement to store local variables in the stack. You could store local variables wherever you like, but traditionally this is how it's done.

## x86: alloca() function

It is worth noting the `alloca()` function <sup>62</sup>. This function works like `malloc()`, but allocates memory directly on the stack. The allocated memory chunk does not have to be freed via a `free()` function call, since the function epilogue ( [1.6 on page 29](#)) returns ESP back to its initial state and the allocated memory is just *dropped*. It is worth noting how `alloca()` is implemented. In simple terms, this function just shifts ESP downwards toward the stack bottom by the number of bytes you need and sets ESP as a pointer to the *allocated* block.

Let's try:

```
#ifdef __GNUC__
#include <alloca.h> // GCC
#else
#include <malloc.h> // MSVC
#endif
#include <stdio.h>

void f()
{
    char *buf=(char*)alloca (600);
#ifdef __GNUC__
    snprintf (buf, 600, "hi! %d, %d, %d\n", 1, 2, 3); // GCC
#else
    _snprintf (buf, 600, "hi! %d, %d, %d\n", 1, 2, 3); // MSVC
#endif

    puts (buf);
};
```

`_snprintf()` function works just like `printf()`, but instead of dumping the result into [stdout](#) (e.g., to terminal or console), it writes it to the `buf` buffer. Function `puts()` copies the contents of `buf` to [stdout](#). Of course, these two function calls might be replaced by one `printf()` call, but we have to illustrate small buffer usage.

## MSVC

Let's compile (MSVC 2010):

Listing 1.40: MSVC 2010

```
...
mov     eax, 600 ; 00000258H
call    __alloca_probe_16
mov     esi, esp

push   3
push   2
push   1
push   OFFSET $SG2672
push   600 ; 00000258H
push   esi
call   __snprintf

push   esi
call   _puts
```

<sup>62</sup>In MSVC, the function implementation can be found in `alloca16.asm` and `chkstk.asm` in `C:\Program Files (x86)\Microsoft Visual Studio 10.0\VC\crt\src\intel`

```
add    esp, 28
...
```

The sole `alloca()` argument is passed via EAX (instead of pushing it into the stack) <sup>63</sup>.

## GCC + Intel syntax

GCC 4.4.1 does the same without calling external functions:

Listing 1.41: GCC 4.7.3

```
.LC0:
.string "hi! %d, %d, %d\n"
f:
    push    ebp
    mov     ebp, esp
    push    ebx
    sub     esp, 660
    lea    ebx, [esp+39]
    and    ebx, -16                ; align pointer by 16-bit border
    mov    DWORD PTR [esp], ebx    ; s
    mov    DWORD PTR [esp+20], 3
    mov    DWORD PTR [esp+16], 2
    mov    DWORD PTR [esp+12], 1
    mov    DWORD PTR [esp+8], OFFSET FLAT:.LC0 ; "hi! %d, %d, %d\n"
    mov    DWORD PTR [esp+4], 600  ; maxlen
    call   _snprintf
    mov    DWORD PTR [esp], ebx    ; s
    call   puts
    mov    ebx, DWORD PTR [ebp-4]
    leave
    ret
```

## GCC + AT&T syntax

Let's see the same code, but in AT&T syntax:

Listing 1.42: GCC 4.7.3

```
.LC0:
.string "hi! %d, %d, %d\n"
f:
    pushl   %ebp
    movl   %esp, %ebp
    pushl   %ebx
    subl   $660, %esp
    leal   39(%esp), %ebx
    andl   $-16, %ebx
    movl   %ebx, (%esp)
    movl   $3, 20(%esp)
    movl   $2, 16(%esp)
    movl   $1, 12(%esp)
    movl   $.LC0, 8(%esp)
    movl   $600, 4(%esp)
    call   _snprintf
    movl   %ebx, (%esp)
    call   puts
    movl   -4(%ebp), %ebx
    leave
    ret
```

<sup>63</sup>It is because `alloca()` is rather a compiler intrinsic ( 11.3 on page 995) than a normal function. One of the reasons we need a separate function instead of just a couple of instructions in the code, is because the `MSVC`<sup>64</sup> `alloca()` implementation also has code which reads from the memory just allocated, in order to let the OS map physical memory to this `VM`<sup>65</sup> region. After the `alloca()` call, ESP points to the block of 600 bytes and we can use it as memory for the `buf` array.

The code is the same as in the previous listing.

By the way, `movl $3, 20(%esp)` corresponds to `mov DWORD PTR [esp+20], 3` in Intel-syntax. In the AT&T syntax, the register+offset format of addressing memory looks like `offset(%register)`.

## (Windows) SEH

[SEH<sup>66</sup>](#) records are also stored on the stack (if they are present). Read more about it: ( [6.5.3 on page 766](#)).

## Buffer overflow protection

More about it here ( [1.26.2 on page 273](#)).

## Automatic deallocation of data in stack

Perhaps the reason for storing local variables and SEH records in the stack is that they are freed automatically upon function exit, using just one instruction to correct the stack pointer (it is often `ADD`). Function arguments, as we could say, are also deallocated automatically at the end of function. In contrast, everything stored in the *heap* must be deallocated explicitly.

### 1.9.3 A typical stack layout

A typical stack layout in a 32-bit environment at the start of a function, before the first instruction execution looks like this:

...	...
ESP-0xC	local variable#2, marked in <a href="#">IDA</a> as <code>var_8</code>
ESP-8	local variable#1, marked in <a href="#">IDA</a> as <code>var_4</code>
ESP-4	saved value of EBP
ESP	Return Address
ESP+4	argument#1, marked in <a href="#">IDA</a> as <code>arg_0</code>
ESP+8	argument#2, marked in <a href="#">IDA</a> as <code>arg_4</code>
ESP+0xC	argument#3, marked in <a href="#">IDA</a> as <code>arg_8</code>
...	...

### 1.9.4 Noise in stack

When one says that something seems random, what one usually means in practice is that one cannot see any regularities in it.

---

Stephen Wolfram, *A New Kind of Science*.

Often in this book “noise” or “garbage” values in the stack or memory are mentioned. Where do they come from? These are what has been left there after other functions’ executions. Short example:

```
#include <stdio.h>

void f1()
{
    int a=1, b=2, c=3;
};

void f2()
{
    int a, b, c;
    printf ("%d, %d, %d\n", a, b, c);
};

int main()
{
    f1();
    f2();
};
```

---

<sup>66</sup>Structured Exception Handling

Compiling ...

Listing 1.43: Non-optimizing MSVC 2010

```
$SG2752 DB      '%d, %d, %d', 0aH, 00H

_c$ = -12      ; size = 4
_b$ = -8       ; size = 4
_a$ = -4       ; size = 4
_f1 PROC
  push        ebp
  mov         ebp, esp
  sub         esp, 12
  mov         DWORD PTR _a$[ebp], 1
  mov         DWORD PTR _b$[ebp], 2
  mov         DWORD PTR _c$[ebp], 3
  mov         esp, ebp
  pop         ebp
  ret         0
_f1 ENDP

_c$ = -12      ; size = 4
_b$ = -8       ; size = 4
_a$ = -4       ; size = 4
_f2 PROC
  push        ebp
  mov         ebp, esp
  sub         esp, 12
  mov         eax, DWORD PTR _c$[ebp]
  push        eax
  mov         ecx, DWORD PTR _b$[ebp]
  push        ecx
  mov         edx, DWORD PTR _a$[ebp]
  push        edx
  push        OFFSET $SG2752 ; '%d, %d, %d'
  call       DWORD PTR __imp__printf
  add         esp, 16
  mov         esp, ebp
  pop         ebp
  ret         0
_f2 ENDP

_main PROC
  push        ebp
  mov         ebp, esp
  call       _f1
  call       _f2
  xor         eax, eax
  pop         ebp
  ret         0
_main ENDP
```

The compiler will grumble a little bit...

```
c:\Polygon>c>cl st.c /Fast.asm /MD
Microsoft (R) 32-bit C/C++ Optimizing Compiler Version 16.00.40219.01 for 80x86
Copyright (C) Microsoft Corporation. All rights reserved.

st.c
c:\polygon\c\st.c(11) : warning C4700: uninitialized local variable 'c' used
c:\polygon\c\st.c(11) : warning C4700: uninitialized local variable 'b' used
c:\polygon\c\st.c(11) : warning C4700: uninitialized local variable 'a' used
Microsoft (R) Incremental Linker Version 10.00.40219.01
Copyright (C) Microsoft Corporation. All rights reserved.

/out:st.exe
st.obj
```

But when we run the compiled program ...



```
c:\Polygon\c>st  
1, 2, 3
```

Oh, what a weird thing! We did not set any variables in `f2()`. These are “ghosts” values, which are still in the stack.

Let's load the example into OllyDbg:

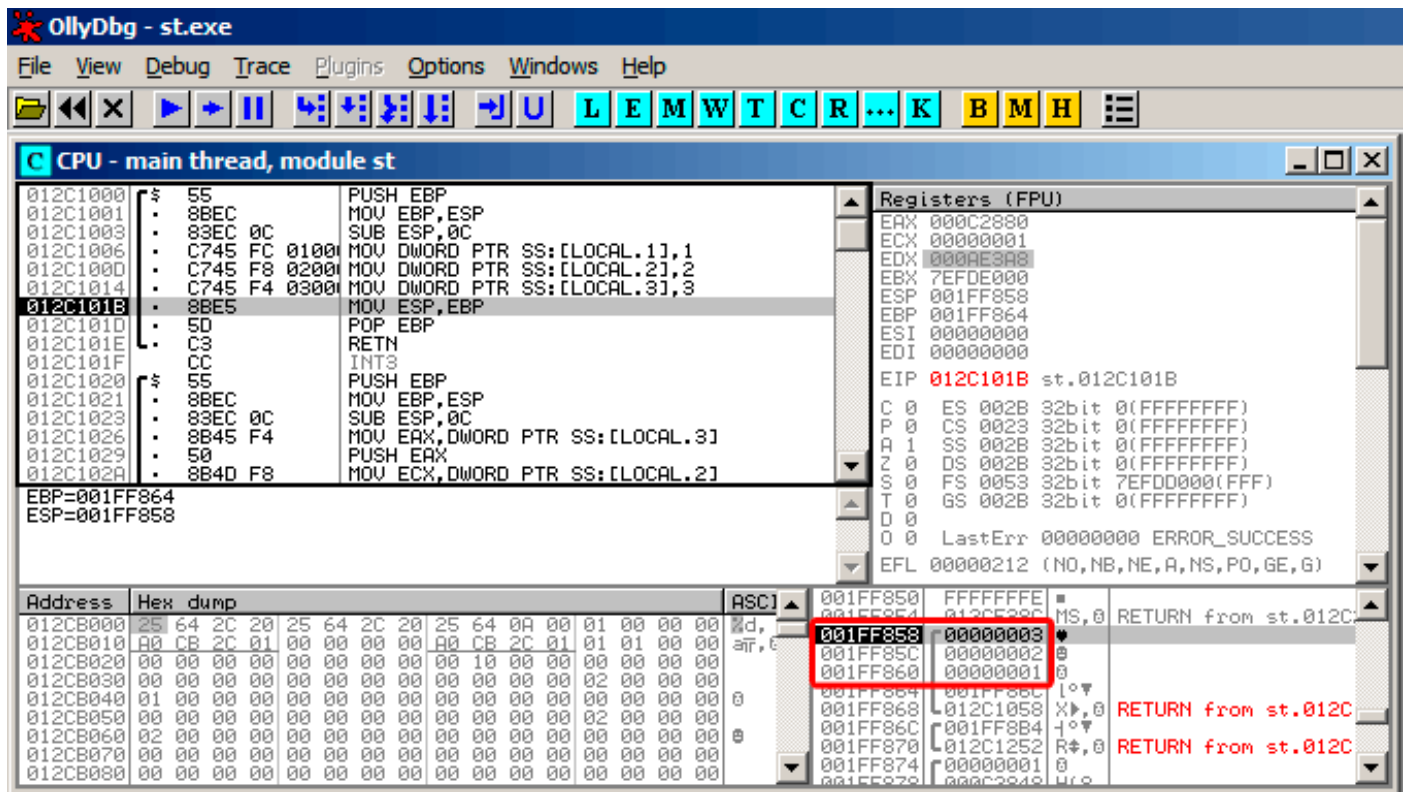

Figure 1.6: OllyDbg: f1()

When `f1()` assigns the variables `a`, `b` and `c`, their values are stored at the address `0x1FF860` and so on.

And when f2() executes:

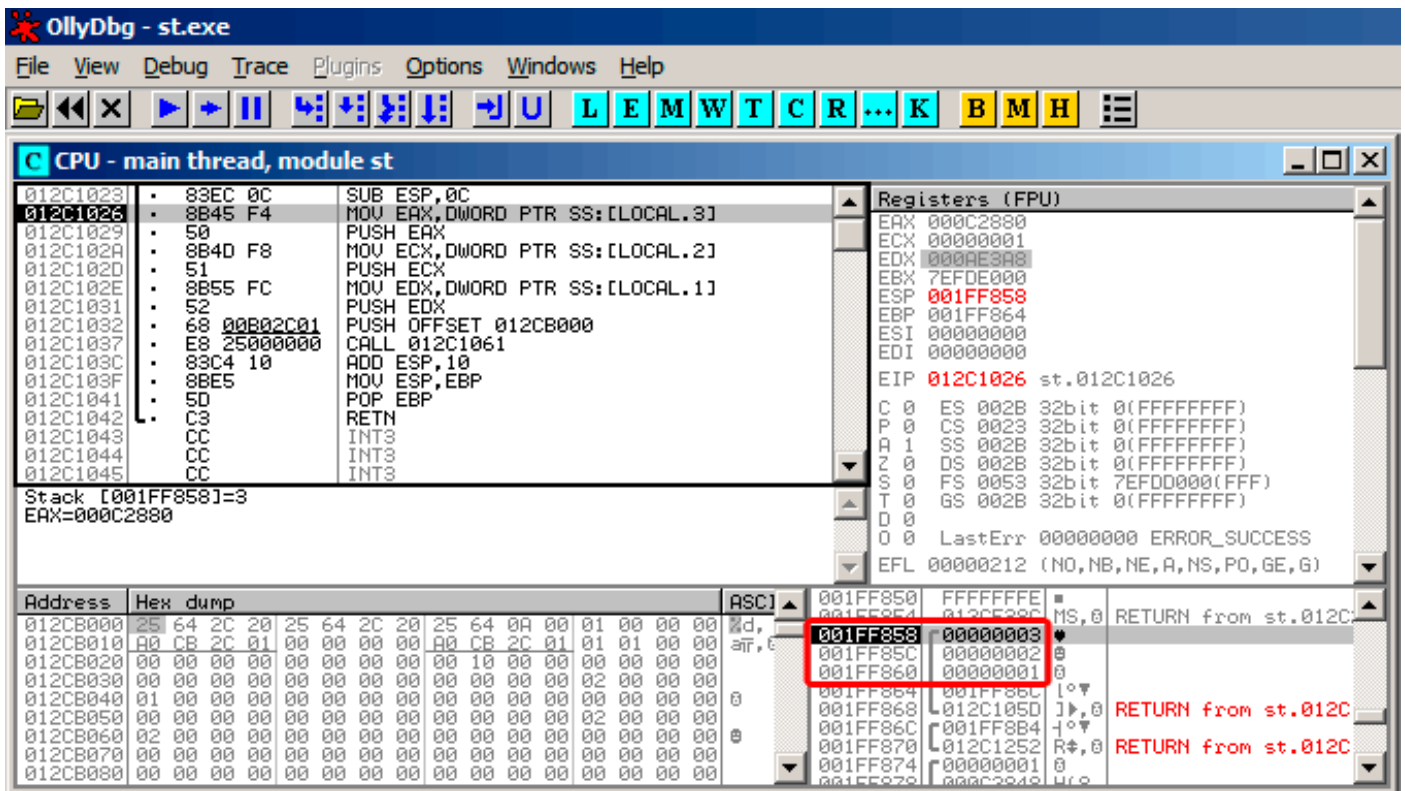

Figure 1.7: OllyDbg: f2()

... *a*, *b* and *c* of f2() are located at the same addresses! No one has overwritten the values yet, so at that point they are still untouched. So, for this weird situation to occur, several functions have to be called one after another and *SP* has to be the same at each function entry (i.e., they have the same number of arguments). Then the local variables will be located at the same positions in the stack. Summarizing, all values in the stack (and memory cells in general) have values left there from previous function executions. They are not random in the strict sense, but rather have unpredictable values. Is there another option? It would probably be possible to clear portions of the stack before each function execution, but that's too much extra (and unnecessary) work.

### MSVC 2013

The example was compiled by MSVC 2010. But the reader of this book made attempt to compile this example in MSVC 2013, ran it, and got all 3 numbers reversed:

```
c:\Polygon\c>st
3, 2, 1
```

Why? I also compiled this example in MSVC 2013 and saw this:

Listing 1.44: MSVC 2013

```
_a$ = -12      ; size = 4
_b$ = -8      ; size = 4
_c$ = -4      ; size = 4
_f2          PROC

...

_f2          ENDP

_c$ = -12     ; size = 4
_b$ = -8     ; size = 4
```

```

_a$ = -4      ; size = 4
_f1 PROC
...
_f1 ENDP

```

Unlike MSVC 2010, MSVC 2013 allocated a/b/c variables in function f2() in reverse order. And this is completely correct, because C/C++ standards has no rule, in which order local variables must be allocated in the local stack, if at all. The reason of difference is because MSVC 2010 has one way to do it, and MSVC 2013 has supposedly something changed inside of compiler guts, so it behaves slightly different.

## 1.9.5 Exercises

- <http://challenges.re/51>
- <http://challenges.re/52>

## 1.10 Almost empty function

This is a real piece of code I found in Boolector<sup>67</sup>:

```

// forward declaration. the function is residing in some other module:
int boolector_main (int argc, char **argv);

// executable
int main (int argc, char **argv)
{
    return boolector_main (argc, argv);
}

```

Why would anyone do so? I don't know, but my best guess is that boolector\_main() may be compiled in some kind of DLL or dynamic library, and be called from a test suite. Surely, a test suite can prepare argc/argv variables as CRT would do it.

Interestingly enough, how this compiles:

Listing 1.45: Non-optimizing GCC 8.2 x64 (assembly output)

```

main:
    push    rbp
    mov     rbp, rsp
    sub     rsp, 16
    mov     DWORD PTR -4[rbp], edi
    mov     QWORD PTR -16[rbp], rsi
    mov     rdx, QWORD PTR -16[rbp]
    mov     eax, DWORD PTR -4[rbp]
    mov     rsi, rdx
    mov     edi, eax
    call   boolector_main
    leave
    ret

```

This is OK, prologue, unnecessary (not optimized) shuffling of two arguments, CALL, epilogue, RET. But let's see optimizing version:

Listing 1.46: Optimizing GCC 8.2 x64 (assembly output)

```

main:
    jmp     boolector_main

```

As simple as that: stack/registers are untouched and boolector\_main() has the same arguments set. So all we need to do is pass execution to another address.

This is close to [thunk function](#).

We will see something more advanced later: [1.11.2 on page 55](#), [1.21.1 on page 156](#).

<sup>67</sup><https://boolector.github.io/>

## 1.11 printf() with several arguments

Now let's extend the *Hello, world!* ( [1.5 on page 8](#) ) example, replacing `printf()` in the `main()` function body with this:

```
#include <stdio.h>

int main()
{
    printf("a=%d; b=%d; c=%d", 1, 2, 3);
    return 0;
};
```

### 1.11.1 x86

#### x86: 3 arguments

#### MSVC

When we compile it with MSVC 2010 Express we get:

```
$SG3830 DB      'a=%d; b=%d; c=%d', 00H

...

    push    3
    push    2
    push    1
    push    OFFSET $SG3830
    call    _printf
    add     esp, 16                ; 00000010H
```

Almost the same, but now we can see the `printf()` arguments are pushed onto the stack in reverse order. The first argument is pushed last.

By the way, variables of *int* type in 32-bit environment have 32-bit width, that is 4 bytes.

So, we have 4 arguments here.  $4 * 4 = 16$  —they occupy exactly 16 bytes in the stack: a 32-bit pointer to a string and 3 numbers of type *int*.

When the [stack pointer](#) (ESP register) has changed back by the `ADD ESP, X` instruction after a function call, often, the number of function arguments could be deduced by simply dividing X by 4.

Of course, this is specific to the *cdecl* calling convention, and only for 32-bit environment.

See also the calling conventions section ( [6.1 on page 735](#) ).

In certain cases where several functions return right after one another, the compiler could merge multiple “ADD ESP, X” instructions into one, after the last call:

```
push a1
push a2
call ...
...
push a1
call ...
...
push a1
push a2
push a3
call ...
add esp, 24
```

Here is a real-world example:

### Listing 1.47: x86

```
.text:100113E7  push    3
.text:100113E9  call   sub_100018B0 ; takes one argument (3)
.text:100113EE  call   sub_100019D0 ; takes no arguments at all
.text:100113F3  call   sub_10006A90 ; takes no arguments at all
.text:100113F8  push    1
.text:100113FA  call   sub_100018B0 ; takes one argument (1)
.text:100113FF  add    esp, 8      ; drops two arguments from stack at once
```

## MSVC and OllyDbg

Now let's try to load this example in OllyDbg. It is one of the most popular user-land win32 debuggers. We can compile our example in MSVC 2012 with /MD option, which means to link with MSVCR\*.DLL, so we can see the imported functions clearly in the debugger.

Then load the executable in OllyDbg. The very first breakpoint is in ntdll.dll, press F9 (run). The second breakpoint is in CRT-code. Now we have to find the main() function.

Find this code by scrolling the code to the very top (MSVC allocates the main() function at the very beginning of the code section):

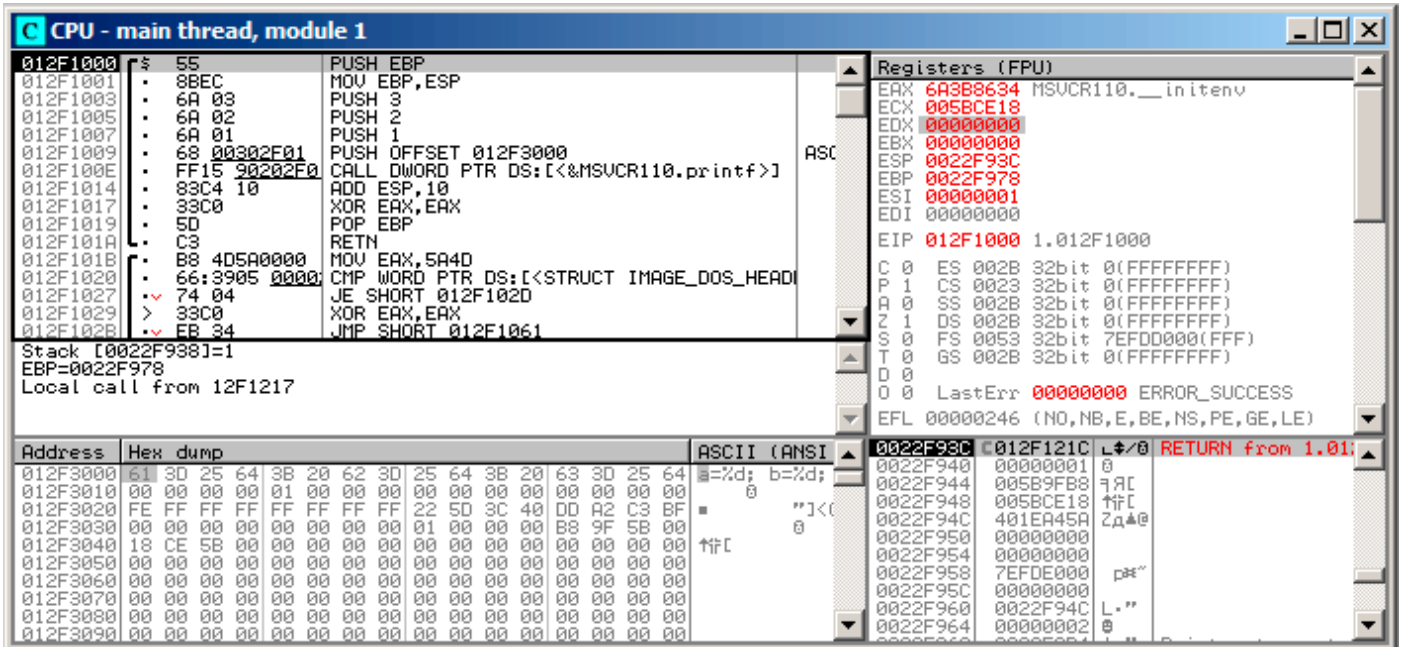

Figure 1.8: OllyDbg: the very start of the main() function

Click on the `PUSH EBP` instruction, press F2 (set breakpoint) and press F9 (run). We have to perform these actions in order to skip CRT-code, because we aren't really interested in it yet.

Press F8 (step over) 6 times, i.e. skip 6 instructions:

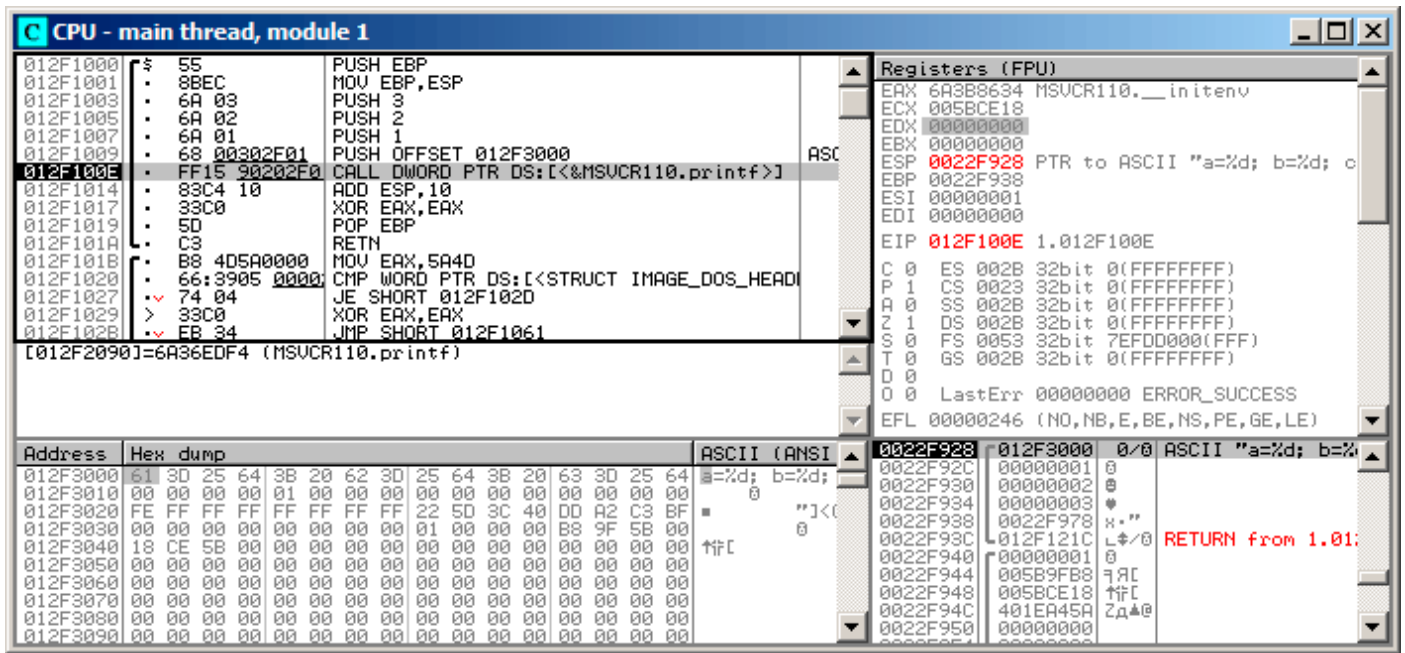

Figure 1.9: OllyDbg: before printf() execution

Now the PC points to the CALL printf instruction. OllyDbg, like other debuggers, highlights the value of the registers which were changed. So each time you press F8, EIP changes and its value is displayed in red. ESP changes as well, because the arguments values are pushed into the stack.

Where are the values in the stack? Take a look at the right bottom debugger window:

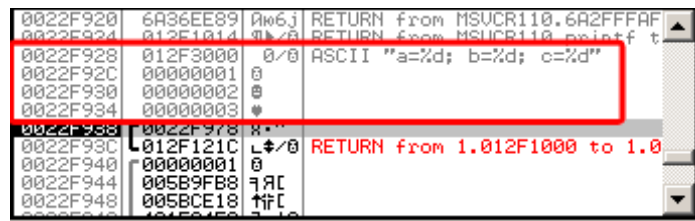

Figure 1.10: OllyDbg: stack after the argument values have been pushed (The red rectangular border was added by the author in a graphics editor)

We can see 3 columns there: address in the stack, value in the stack and some additional OllyDbg comments. OllyDbg understands printf()-like strings, so it reports the string here and the 3 values attached to it.

It is possible to right-click on the format string, click on "Follow in dump", and the format string will appear in the debugger left-bottom window, which always displays some part of the memory. These memory values can be edited. It is possible to change the format string, in which case the result of our example would be different. It is not very useful in this particular case, but it could be good as an exercise so you start building a feel of how everything works here.



Press F8 (step over).

We see the following output in the console:

```
a=1; b=2; c=3
```

Let's see how the registers and stack state have changed:

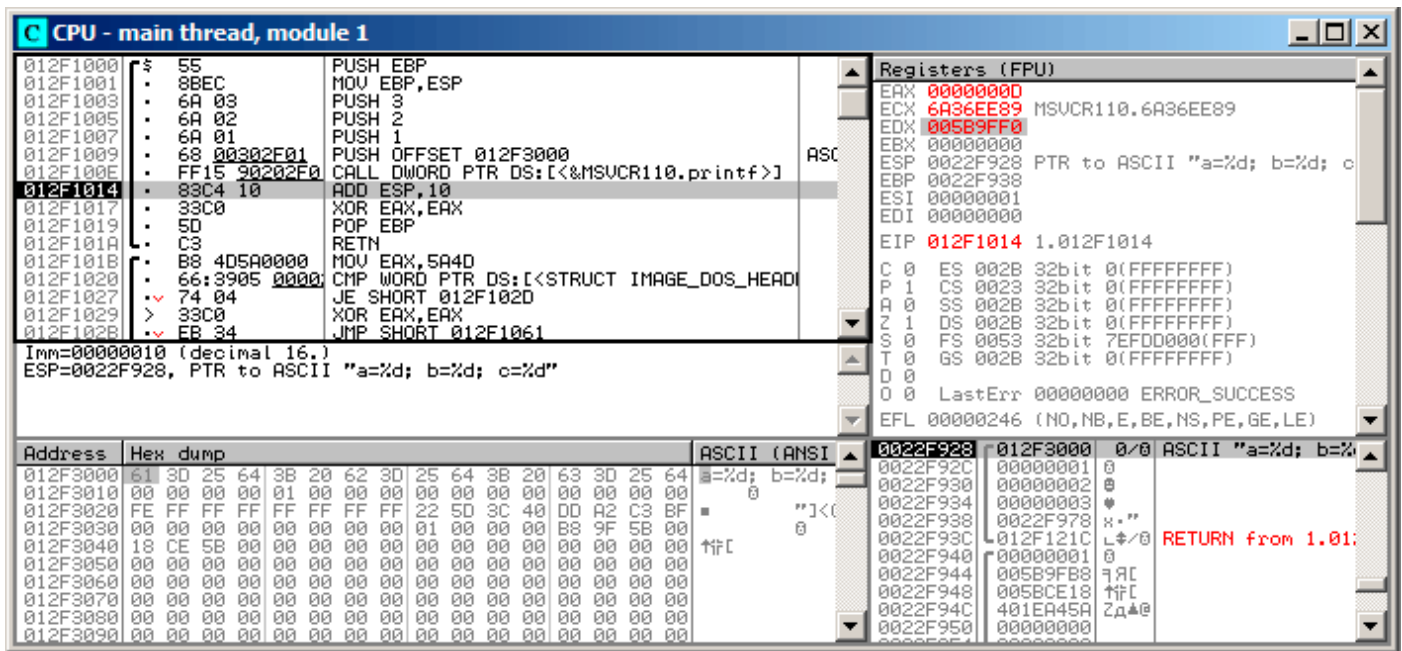

Figure 1.11: OllyDbg after printf() execution

Register EAX now contains 0xD (13). That is correct, since printf() returns the number of characters printed. The value of EIP has changed: indeed, now it contains the address of the instruction coming after CALL printf. ECX and EDX values have changed as well. Apparently, the printf() function's hidden machinery used them for its own needs.

A very important fact is that neither the ESP value, nor the stack state have been changed! We clearly see that the format string and corresponding 3 values are still there. This is indeed the *cdecl* calling convention behavior: *callee* does not return ESP back to its previous value. The *caller* is responsible to do so.

Press F8 again to execute ADD ESP, 10 instruction:

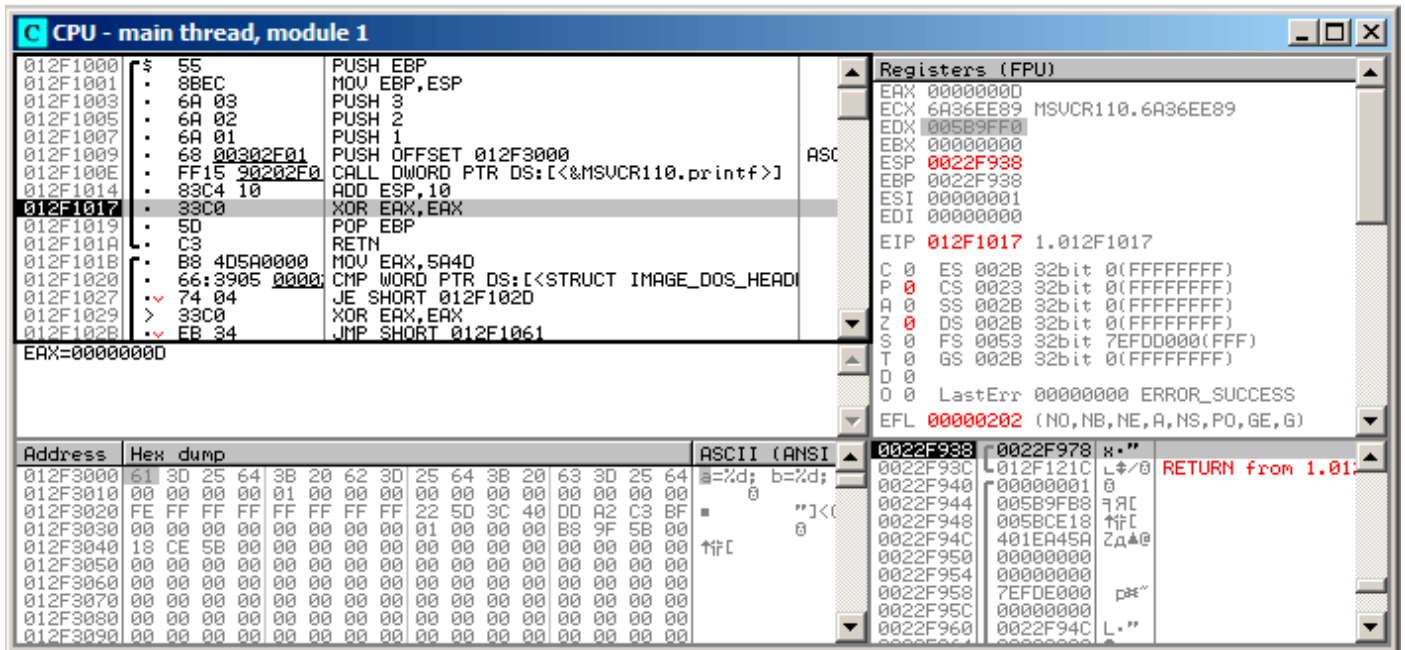

Figure 1.12: OllyDbg: after ADD ESP, 10 instruction execution

ESP has changed, but the values are still in the stack! Yes, of course; no one needs to set these values to zeros or something like that. Everything above the stack pointer (SP) is *noise* or *garbage* and has no meaning at all. It would be time consuming to clear the unused stack entries anyway, and no one really needs to.

### GCC

Now let's compile the same program in Linux using GCC 4.4.1 and take a look at what we have got in IDA:

```

main      proc near

var_10    = dword ptr -10h
var_C     = dword ptr -0Ch
var_8     = dword ptr -8
var_4     = dword ptr -4

        push    ebp
        mov     ebp, esp
        and     esp, 0FFFFFF0h
        sub     esp, 10h
        mov     eax, offset aADBDCD ; "a=%d; b=%d; c=%d"
        mov     [esp+10h+var_4], 3
        mov     [esp+10h+var_8], 2
        mov     [esp+10h+var_C], 1
        mov     [esp+10h+var_10], eax
        call   _printf
        mov     eax, 0
        leave
        retn
main      endp
    
```

Its noticeable that the difference between the MSVC code and the GCC code is only in the way the arguments are stored on the stack. Here the GCC is working directly with the stack without the use of PUSH/POP.

### GCC and GDB

Let's try this example also in [GDB<sup>68</sup>](#) in Linux.

-g option instructs the compiler to include debug information in the executable file.

```
$ gcc 1.c -g -o 1
```

```
$ gdb 1
GNU gdb (GDB) 7.6.1-ubuntu
...
Reading symbols from /home/dennis/polygon/1...done.
```

Listing 1.48: let's set breakpoint on printf()

```
(gdb) b printf
Breakpoint 1 at 0x80482f0
```

Run. We don't have the printf() function source code here, so [GDB](#) can't show it, but may do so.

```
(gdb) run
Starting program: /home/dennis/polygon/1

Breakpoint 1, _printf (format=0x80484f0 "a=%d; b=%d; c=%d") at printf.c:29
29      printf.c: No such file or directory.
```

Print 10 stack elements. The most left column contains addresses on the stack.

```
(gdb) x/10w $esp
0xbffff11c: 0x0804844a    0x080484f0    0x00000001    0x00000002
0xbffff12c: 0x00000003    0x08048460    0x00000000    0x00000000
0xbffff13c: 0xb7e29905    0x00000001
```

The very first element is the [RA](#) (0x0804844a). We can verify this by disassembling the memory at this address:

```
(gdb) x/5i 0x0804844a
0x804844a <main+45>: mov    $0x0,%eax
0x804844f <main+50>: leave
0x8048450 <main+51>: ret
0x8048451:  xchg  %ax,%ax
0x8048453:  xchg  %ax,%ax
```

The two XCHG instructions are idle instructions, analogous to [NOPs](#).

The second element (0x080484f0) is the format string address:

```
(gdb) x/s 0x080484f0
0x80484f0: "a=%d; b=%d; c=%d"
```

Next 3 elements (1, 2, 3) are the printf() arguments. The rest of the elements could be just "garbage" on the stack, but could also be values from other functions, their local variables, etc. We can ignore them for now.

Run "finish". The command instructs GDB to "execute all instructions until the end of the function". In this case: execute till the end of printf().

<sup>68</sup>GNU Debugger

```
(gdb) finish
Run till exit from #0  __printf (format=0x80484f0 "a=%d; b=%d; c=%d") at printf.c:29
main () at 1.c:6
6      return 0;
Value returned is $2 = 13
```

**GDB** shows what `printf()` returned in `EAX` (13). This is the number of characters printed out, just like in the `OllyDbg` example.

We also see “return 0;” and the information that this expression is in the `1.c` file at the line 6. Indeed, the `1.c` file is located in the current directory, and **GDB** finds the string there. How does **GDB** know which C-code line is being currently executed? This is due to the fact that the compiler, while generating debugging information, also saves a table of relations between source code line numbers and instruction addresses. **GDB** is a source-level debugger, after all.

Let's examine the registers. 13 in `EAX`:

```
(gdb) info registers
eax          0xd      13
ecx          0x0      0
edx          0x0      0
ebx          0xb7fc0000  -1208221696
esp          0xbffff120  0xbffff120
ebp          0xbffff138  0xbffff138
esi          0x0      0
edi          0x0      0
eip          0x804844a   0x804844a <main+45>
...
```

Let's disassemble the current instructions. The arrow points to the instruction to be executed next.

```
(gdb) disas
Dump of assembler code for function main:
0x0804841d <+0>:  push  %ebp
0x0804841e <+1>:  mov   %esp,%ebp
0x08048420 <+3>:  and  $0xffffffff0,%esp
0x08048423 <+6>:  sub  $0x10,%esp
0x08048426 <+9>:  movl $0x3,0xc(%esp)
0x0804842e <+17>: movl $0x2,0x8(%esp)
0x08048436 <+25>: movl $0x1,0x4(%esp)
0x0804843e <+33>: movl $0x80484f0,(%esp)
0x08048445 <+40>: call 0x80482f0 <printf@plt>
=> 0x0804844a <+45>: mov  $0x0,%eax
0x0804844f <+50>: leave
0x08048450 <+51>: ret
End of assembler dump.
```

**GDB** uses AT&T syntax by default. But it is possible to switch to Intel syntax:

```
(gdb) set disassembly-flavor intel
(gdb) disas
Dump of assembler code for function main:
0x0804841d <+0>:  push  ebp
0x0804841e <+1>:  mov   ebp,esp
0x08048420 <+3>:  and  esp,0xffffffff0
0x08048423 <+6>:  sub  esp,0x10
0x08048426 <+9>:  mov  DWORD PTR [esp+0xc],0x3
0x0804842e <+17>: mov  DWORD PTR [esp+0x8],0x2
0x08048436 <+25>: mov  DWORD PTR [esp+0x4],0x1
0x0804843e <+33>: mov  DWORD PTR [esp],0x80484f0
0x08048445 <+40>: call 0x80482f0 <printf@plt>
=> 0x0804844a <+45>: mov  eax,0x0
0x0804844f <+50>: leave
0x08048450 <+51>: ret
End of assembler dump.
```

Execute next instruction. [GDB](#) shows ending bracket, meaning, it ends the block.

```
(gdb) step
7      };
```

Let's examine the registers after the `MOV EAX, 0` instruction execution. Indeed `EAX` is zero at that point.

```
(gdb) info registers
eax          0x0          0
ecx          0x0          0
edx          0x0          0
ebx          0xb7fc0000   -1208221696
esp          0xbffff120   0xbffff120
ebp          0xbffff138   0xbffff138
esi          0x0          0
edi          0x0          0
eip          0x804844f     0x804844f <main+50>
...
```

### x64: 8 arguments

To see how other arguments are passed via the stack, let's change our example again by increasing the number of arguments to 9 (`printf()` format string + 8 `int` variables):

```
#include <stdio.h>

int main()
{
    printf("a=%d; b=%d; c=%d; d=%d; e=%d; f=%d; g=%d; h=%d\n", 1, 2, 3, 4, 5, 6, 7, 8);
    return 0;
};
```

### MSVC

As it was mentioned earlier, the first 4 arguments has to be passed through the `RCX`, `RDX`, `R8`, `R9` registers in Win64, while all the rest—via the stack. That is exactly what we see here. However, the `MOV` instruction, instead of `PUSH`, is used for preparing the stack, so the values are stored to the stack in a straightforward manner.

Listing 1.49: MSVC 2012 x64

```
$SG2923 DB      'a=%d; b=%d; c=%d; d=%d; e=%d; f=%d; g=%d; h=%d', 0aH, 00H

main      PROC
          sub     rsp, 88

          mov     DWORD PTR [rsp+64], 8
          mov     DWORD PTR [rsp+56], 7
          mov     DWORD PTR [rsp+48], 6
          mov     DWORD PTR [rsp+40], 5
          mov     DWORD PTR [rsp+32], 4
          mov     r9d, 3
          mov     r8d, 2
          mov     edx, 1
          lea    rcx, OFFSET FLAT:$SG2923
          call   printf

          ; return 0
          xor     eax, eax

          add     rsp, 88
          ret     0
main      ENDP
_TEXT    ENDS
END
```

The observant reader may ask why are 8 bytes allocated for *int* values, when 4 is enough? Yes, one has to recall: 8 bytes are allocated for any data type shorter than 64 bits. This is established for the convenience's sake: it makes it easy to calculate the address of arbitrary argument. Besides, they are all located at aligned memory addresses. It is the same in the 32-bit environments: 4 bytes are reserved for all data types.

## GCC

The picture is similar for x86-64 \*NIX OS-es, except that the first 6 arguments are passed through the RDI, RSI, RDX, RCX, R8, R9 registers. All the rest—via the stack. GCC generates the code storing the string pointer into EDI instead of RDI—we noted that previously: [1.5.2 on page 15](#).

We also noted earlier that the EAX register has been cleared before a `printf()` call: [1.5.2 on page 15](#).

Listing 1.50: Optimizing GCC 4.4.6 x64

```
.LC0:
    .string "a=%d; b=%d; c=%d; d=%d; e=%d; f=%d; g=%d; h=%d\n"

main:
    sub     rsp, 40

    mov     r9d, 5
    mov     r8d, 4
    mov     ecx, 3
    mov     edx, 2
    mov     esi, 1
    mov     edi, OFFSET FLAT:.LC0
    xor     eax, eax ; number of vector registers passed
    mov     DWORD PTR [rsp+16], 8
    mov     DWORD PTR [rsp+8], 7
    mov     DWORD PTR [rsp], 6
    call    printf

    ; return 0

    xor     eax, eax
    add     rsp, 40
    ret
```

## GCC + GDB

Let's try this example in [GDB](#).

```
$ gcc -g 2.c -o 2
```

```
$ gdb 2
GNU gdb (GDB) 7.6.1-ubuntu
...
Reading symbols from /home/dennis/polygon/2...done.
```

Listing 1.51: let's set the breakpoint to `printf()`, and run

```
(gdb) b printf
Breakpoint 1 at 0x400410
(gdb) run
Starting program: /home/dennis/polygon/2

Breakpoint 1, __printf (format=0x400628 "a=%d; b=%d; c=%d; d=%d; e=%d; f=%d; g=%d; h=%d\n") at ↵
↳ printf.c:29
29     printf.c: No such file or directory.
```

Registers RSI/RDX/RCX/R8/R9 have the expected values. RIP has the address of the very first instruction of the `printf()` function.

```
(gdb) info registers
rax          0x0      0
rbx          0x0      0
rcx          0x3      3
rdx          0x2      2
rsi          0x1      1
rdi          0x400628 4195880
rbp          0x7fffffffdf60 0x7fffffffdf60
rsp          0x7fffffffdf38 0x7fffffffdf38
r8           0x4      4
r9           0x5      5
r10          0x7fffffffdfce0 140737488346336
r11          0x7ffff7a65f60 140737348263776
r12          0x400440 4195392
r13          0x7fffffffef040 140737488347200
r14          0x0      0
r15          0x0      0
rip          0x7ffff7a65f60 0x7ffff7a65f60 <__printf>
...
```

Listing 1.52: let's inspect the format string

```
(gdb) x/s $rdi
0x400628:      "a=%d; b=%d; c=%d; d=%d; e=%d; f=%d; g=%d; h=%d\n"
```

Let's dump the stack with the `x/g` command this time—`g` stands for *giant words*, i.e., 64-bit words.

```
(gdb) x/10g $rsp
0x7fffffffdf38: 0x0000000000400576      0x0000000000000006
0x7fffffffdf48: 0x0000000000000007      0x00007fff00000008
0x7fffffffdf58: 0x0000000000000000      0x0000000000000000
0x7fffffffdf68: 0x00007ffff7a33de5      0x0000000000000000
0x7fffffffdf78: 0x00007fffffe048      0x0000000010000000
```

The very first stack element, just like in the previous case, is the `RA`. 3 values are also passed through the stack: 6, 7, 8. We also see that 8 is passed with the high 32-bits not cleared: `0x00007fff00000008`. That's OK, because the values are of `int` type, which is 32-bit. So, the high register or stack element part may contain "random garbage".

If you take a look at where the control will return after the `printf()` execution, `GDB` will show the entire `main()` function:

```
(gdb) set disassembly-flavor intel
(gdb) disas 0x0000000000400576
Dump of assembler code for function main:
   0x000000000040052d <+0>:      push  rbp
   0x000000000040052e <+1>:      mov   rbp, rsp
   0x0000000000400531 <+4>:      sub   rsp, 0x20
   0x0000000000400535 <+8>:      mov   DWORD PTR [rsp+0x10], 0x8
   0x000000000040053d <+16>:     mov   DWORD PTR [rsp+0x8], 0x7
   0x0000000000400545 <+24>:     mov   DWORD PTR [rsp], 0x6
   0x000000000040054c <+31>:     mov   r9d, 0x5
   0x0000000000400552 <+37>:     mov   r8d, 0x4
   0x0000000000400558 <+43>:     mov   ecx, 0x3
   0x000000000040055d <+48>:     mov   edx, 0x2
   0x0000000000400562 <+53>:     mov   esi, 0x1
   0x0000000000400567 <+58>:     mov   edi, 0x400628
   0x000000000040056c <+63>:     mov   eax, 0x0
   0x0000000000400571 <+68>:     call 0x400410 <printf@plt>
   0x0000000000400576 <+73>:     mov   eax, 0x0
   0x000000000040057b <+78>:     leave
```

```
0x00000000040057c <+79>:    ret
End of assembler dump.
```

Let's finish executing `printf()`, execute the instruction zeroing EAX, and note that the EAX register has a value of exactly zero. RIP now points to the LEAVE instruction, i.e., the penultimate one in the `main()` function.

```
(gdb) finish
Run till exit from #0 __printf (format=0x400628 "a=%d; b=%d; c=%d; d=%d; e=%d; f=%d; g=%d; h=%d\n") at printf.c:29
↳ d\n") at printf.c:29
a=1; b=2; c=3; d=4; e=5; f=6; g=7; h=8
main () at 2.c:6
6         return 0;
Value returned is $1 = 39
(gdb) next
7         };
(gdb) info registers
rax          0x0          0
rbx          0x0          0
rcx          0x26         38
rdx          0x7ffff7dd59f0  140737351866864
rsi          0x7fffffd9      2147483609
rdi          0x0          0
rbp          0x7ffffffffff60  0x7ffffffffff60
rsp          0x7ffffffffff40  0x7ffffffffff40
r8           0x7ffff7dd26a0    140737351853728
r9           0x7ffff7a60134    140737348239668
r10          0x7ffff7a60134    140737348239668
r11          0x7ffff7a95900    140737348458752
r12          0x400440 4195392
r13          0x7ffffffffffe040  140737488347200
r14          0x0          0
r15          0x0          0
rip          0x40057b 0x40057b <main+78>
...
```

## 1.11.2 ARM

### ARM: 3 arguments

ARM's traditional scheme for passing arguments (calling convention) behaves as follows: the first 4 arguments are passed through the R0-R3 registers; the remaining arguments via the stack. This resembles the arguments passing scheme in `fastcall` ([6.1.3 on page 736](#)) or `win64` ([6.1.5 on page 738](#)).

### 32-bit ARM

#### Non-optimizing Keil 6/2013 (ARM mode)

Listing 1.53: Non-optimizing Keil 6/2013 (ARM mode)

```
.text:00000000 main
.text:00000000 10 40 2D E9   STMFDP   SP!, {R4,LR}
.text:00000004 03 30 A0 E3   MOV     R3, #3
.text:00000008 02 20 A0 E3   MOV     R2, #2
.text:0000000C 01 10 A0 E3   MOV     R1, #1
.text:00000010 08 00 8F E2   ADR     R0, aADBDCD ; "a=%d; b=%d; c=%d"
.text:00000014 06 00 00 EB   BL     __2printf
.text:00000018 00 00 A0 E3   MOV     R0, #0 ; return 0
.text:0000001C 10 80 BD E8   LDMFDP   SP!, {R4,PC}
```



So, the first 4 arguments are passed via the R0-R3 registers in this order: a pointer to the printf() format string in R0, then 1 in R1, 2 in R2 and 3 in R3. The instruction at 0x18 writes 0 to R0—this is *return 0* C-statement. There is nothing unusual so far.

Optimizing Keil 6/2013 generates the same code.

### Optimizing Keil 6/2013 (Thumb mode)

Listing 1.54: Optimizing Keil 6/2013 (Thumb mode)

```
.text:00000000 main
.text:00000000 10 B5      PUSH   {R4,LR}
.text:00000002 03 23      MOVS   R3, #3
.text:00000004 02 22      MOVS   R2, #2
.text:00000006 01 21      MOVS   R1, #1
.text:00000008 02 A0      ADR    R0, aADBDCD      ; "a=%d; b=%d; c=%d"
.text:0000000A 00 F0 0D F8  BL    __2printf
.text:0000000E 00 20      MOVS   R0, #0
.text:00000010 10 BD      POP    {R4,PC}
```

There is no significant difference from the non-optimized code for ARM mode.

### Optimizing Keil 6/2013 (ARM mode) + let's remove return

Let's rework example slightly by removing *return 0*:

```
#include <stdio.h>

void main()
{
    printf("a=%d; b=%d; c=%d", 1, 2, 3);
};
```

The result is somewhat unusual:

Listing 1.55: Optimizing Keil 6/2013 (ARM mode)

```
.text:00000014 main
.text:00000014 03 30 A0 E3  MOV    R3, #3
.text:00000018 02 20 A0 E3  MOV    R2, #2
.text:0000001C 01 10 A0 E3  MOV    R1, #1
.text:00000020 1E 0E 8F E2  ADR    R0, aADBDCD      ; "a=%d; b=%d; c=%d\n"
.text:00000024 CB 18 00 EA   B      __2printf
```

This is the optimized (-O3) version for ARM mode and this time we see B as the last instruction instead of the familiar BL. Another difference between this optimized version and the previous one (compiled without optimization) is the lack of function prologue and epilogue (instructions preserving the R0 and LR registers values). The B instruction just jumps to another address, without any manipulation of the LR register, similar to JMP in x86. Why does it work? Because this code is, in fact, effectively equivalent to the previous. There are two main reasons: 1) neither the stack nor SP (the [stack pointer](#)) is modified; 2) the call to printf() is the last instruction, so there is nothing going on afterwards. On completion, the printf() function simply returns the control to the address stored in LR. Since the LR currently stores the address of the point from where our function has been called then the control from printf() will be returned to that point. Therefore we do not have to save LR because we do not have necessity to modify LR. And we do not have necessity to modify LR because there are no other function calls except printf(). Furthermore, after this call we do not to do anything else! That is the reason such optimization is possible.

This optimization is often used in functions where the last statement is a call to another function. A similar example is presented here: [1.21.1 on page 156](#).

A somewhat simpler case was described above: [1.10 on page 42](#).

## ARM64

## Non-optimizing GCC (Linaro) 4.9

Listing 1.56: Non-optimizing GCC (Linaro) 4.9

```
.LC1:
    .string "a=%d; b=%d; c=%d"
f2:
; save FP and LR in stack frame:
    stp    x29, x30, [sp, -16]!
; set stack frame (FP=SP):
    add    x29, sp, 0
    adrp   x0, .LC1
    add    x0, x0, :lo12:.LC1
    mov    w1, 1
    mov    w2, 2
    mov    w3, 3
    bl     printf
    mov    w0, 0
; restore FP and LR
    ldp    x29, x30, [sp], 16
    ret
```

The first instruction STP (*Store Pair*) saves FP (X29) and LR (X30) in the stack. The second ADD X29, SP, 0 instruction forms the stack frame. It is just writing the value of SP into X29.

Next, we see the familiar ADRP/ADD instruction pair, which forms a pointer to the string. *lo12* meaning low 12 bits, i.e., linker will write low 12 bits of LC1 address into the opcode of ADD instruction. %d in printf() string format is a 32-bit *int*, so the 1, 2 and 3 are loaded into 32-bit register parts.

Optimizing GCC (Linaro) 4.9 generates the same code.

### ARM: 8 arguments

Let's use again the example with 9 arguments from the previous section: [1.11.1 on page 51](#).

```
#include <stdio.h>

int main()
{
    printf("a=%d; b=%d; c=%d; d=%d; e=%d; f=%d; g=%d; h=%d\n", 1, 2, 3, 4, 5, 6, 7, 8);
    return 0;
};
```

### Optimizing Keil 6/2013: ARM mode

```
.text:00000028          main
.text:00000028
.text:00000028          var_18 = -0x18
.text:00000028          var_14 = -0x14
.text:00000028          var_4  = -4
.text:00000028
.text:00000028 04 E0 2D E5  STR    LR, [SP,#var_4]!
.text:0000002C 14 D0 4D E2  SUB    SP, SP, #0x14
.text:00000030 08 30 A0 E3  MOV    R3, #8
.text:00000034 07 20 A0 E3  MOV    R2, #7
.text:00000038 06 10 A0 E3  MOV    R1, #6
.text:0000003C 05 00 A0 E3  MOV    R0, #5
.text:00000040 04 C0 8D E2  ADD    R12, SP, #0x18+var_14
.text:00000044 0F 00 8C E8  STMIA  R12, {R0-R3}
.text:00000048 04 00 A0 E3  MOV    R0, #4
.text:0000004C 00 00 8D E5  STR    R0, [SP,#0x18+var_18]
.text:00000050 03 30 A0 E3  MOV    R3, #3
.text:00000054 02 20 A0 E3  MOV    R2, #2
.text:00000058 01 10 A0 E3  MOV    R1, #1
.text:0000005C 6E 0F 8F E2  ADR    R0, aADBDCDDDEDFDGD ; "a=%d; b=%d; c=%d; d=%d; e=%d; f=%d;
g=%d"...
.text:00000060 BC 18 00 EB  BL     __2printf
.text:00000064 14 D0 8D E2  ADD    SP, SP, #0x14
```

```
.text:00000068 04 F0 9D E4 LDR PC, [SP+4+var_4],#4
```

This code can be divided into several parts:

- Function prologue:

The very first STR LR, [SP,#var\_4]! instruction saves LR on the stack, because we are going to use this register for the printf() call. Exclamation mark at the end indicates *pre-index*.

This implies that SP is to be decreased by 4 first, and then LR will be saved at the address stored in SP. This is similar to PUSH in x86. Read more about it at: [1.39.2 on page 440](#).

The second SUB SP, SP, #0x14 instruction decreases SP (the *stack pointer*) in order to allocate 0x14 (20) bytes on the stack. Indeed, we have to pass 5 32-bit values via the stack to the printf() function, and each one occupies 4 bytes, which is exactly  $5 * 4 = 20$ . The other 4 32-bit values are to be passed through registers.

- Passing 5, 6, 7 and 8 via the stack: they are stored in the R0, R1, R2 and R3 registers respectively. Then, the ADD R12, SP, #0x18+var\_14 instruction writes the stack address where these 4 variables are to be stored, into the R12 register. var\_14 is an assembly macro, equal to -0x14, created by IDA to conveniently display the code accessing the stack. The var\_? macros generated by IDA reflect local variables in the stack.

So, SP+4 is to be stored into the R12 register.

The next STMIA R12, R0-R3 instruction writes registers R0-R3 contents to the memory pointed by R12. STMIA abbreviates *Store Multiple Increment After*. *Increment After* implies that R12 is to be increased by 4 after each register value is written.

- Passing 4 via the stack: 4 is stored in R0 and then this value, with the help of the STR R0, [SP,#0x18+var\_18] instruction is saved on the stack. var\_18 is -0x18, so the offset is to be 0, thus the value from the R0 register (4) is to be written to the address written in SP.
- Passing 1, 2 and 3 via registers: The values of the first 3 numbers (a, b, c) (1, 2, 3 respectively) are passed through the R1, R2 and R3 registers right before the printf() call, and the other 5 values are passed via the stack:
- printf() call.
- Function epilogue:

The ADD SP, SP, #0x14 instruction restores the SP pointer back to its former value, thus annulling everything what has been stored on the stack. Of course, what has been stored on the stack will stay there, but it will all be rewritten during the execution of subsequent functions.

The LDR PC, [SP+4+var\_4],#4 instruction loads the saved LR value from the stack into the PC register, thus causing the function to exit. There is no exclamation mark—indeed, PC is loaded first from the address stored in SP ( $4 + var\_4 = 4 + (-4) = 0$ ), so this instruction is analogous to LDR PC, [SP],#4, and then SP is increased by 4. This is referred as *post-index*<sup>69</sup>. Why does IDA display the instruction like that? Because it wants to illustrate the stack layout and the fact that var\_4 is allocated for saving the LR value in the local stack. This instruction is somewhat similar to POP PC in x86<sup>70</sup>.

## Optimizing Keil 6/2013: Thumb mode

```
.text:0000001C          printf_main2
.text:0000001C
.text:0000001C          var_18 = -0x18
.text:0000001C          var_14 = -0x14
.text:0000001C          var_8  = -8
.text:0000001C
.text:0000001C 00 B5          PUSH    {LR}
.text:0000001E 08 23          MOVS    R3, #8
.text:00000020 85 B0          SUB     SP, SP, #0x14
.text:00000022 04 93          STR     R3, [SP,#0x18+var_8]
.text:00000024 07 22          MOVS    R2, #7
.text:00000026 06 21          MOVS    R1, #6
.text:00000028 05 20          MOVS    R0, #5
.text:0000002A 01 AB          ADD     R3, SP, #0x18+var_14
.text:0000002C 07 C3          STMIA  R3!, {R0-R2}
```

<sup>69</sup>Read more about it: [1.39.2 on page 440](#).

<sup>70</sup>It is impossible to set IP/EIP/RIP value using POP in x86, but anyway, you got the analogy right.

```

.text:0000002E 04 20      MOVS    R0, #4
.text:00000030 00 90      STR     R0, [SP,#0x18+var_18]
.text:00000032 03 23      MOVS    R3, #3
.text:00000034 02 22      MOVS    R2, #2
.text:00000036 01 21      MOVS    R1, #1
.text:00000038 A0 A0      ADR     R0, aADBDCDDDEDFDGD ; "a=%d; b=%d; c=%d; d=%d; e=%d; f=%d;
      g=%d"...
.text:0000003A 06 F0 D9 F8 BL      __2printf
.text:0000003E      loc_3E ; CODE XREF: example13_f+16
.text:0000003E 05 B0      ADD     SP, SP, #0x14
.text:00000040 00 BD      POP     {PC}

```

The output is almost like in the previous example. However, this is Thumb code and the values are packed into stack differently: 8 goes first, then 5, 6, 7, and 4 goes third.

### Optimizing Xcode 4.6.3 (LLVM): ARM mode

```

__text:0000290C      _printf_main2
__text:0000290C      var_1C = -0x1C
__text:0000290C      var_C = -0xC
__text:0000290C 80 40 2D E9      STMFDP SP!, {R7,LR}
__text:00002910 0D 70 A0 E1      MOV     R7, SP
__text:00002914 14 D0 4D E2      SUB     SP, SP, #0x14
__text:00002918 70 05 01 E3      MOV     R0, #0x1570
__text:0000291C 07 C0 A0 E3      MOV     R12, #7
__text:00002920 00 00 40 E3      MOVT   R0, #0
__text:00002924 04 20 A0 E3      MOV     R2, #4
__text:00002928 00 00 8F E0      ADD     R0, PC, R0
__text:0000292C 06 30 A0 E3      MOV     R3, #6
__text:00002930 05 10 A0 E3      MOV     R1, #5
__text:00002934 00 20 8D E5      STR     R2, [SP,#0x1C+var_1C]
__text:00002938 0A 10 8D E9      STMFA  SP, {R1,R3,R12}
__text:0000293C 08 90 A0 E3      MOV     R9, #8
__text:00002940 01 10 A0 E3      MOV     R1, #1
__text:00002944 02 20 A0 E3      MOV     R2, #2
__text:00002948 03 30 A0 E3      MOV     R3, #3
__text:0000294C 10 90 8D E5      STR     R9, [SP,#0x1C+var_C]
__text:00002950 A4 05 00 EB      BL      _printf
__text:00002954 07 D0 A0 E1      MOV     SP, R7
__text:00002958 80 80 BD E8      LDMFDP SP!, {R7,PC}

```

Almost the same as what we have already seen, with the exception of STMFA (Store Multiple Full Ascending) instruction, which is a synonym of STMIB (Store Multiple Increment Before) instruction. This instruction increases the value in the `SP` register and only then writes the next register value into the memory, rather than performing those two actions in the opposite order.

Another thing that catches the eye is that the instructions are arranged seemingly random. For example, the value in the `R0` register is manipulated in three places, at addresses `0x2918`, `0x2920` and `0x2928`, when it would be possible to do it in one point.

However, the optimizing compiler may have its own reasons on how to order the instructions so to achieve higher efficiency during the execution.

Usually, the processor attempts to simultaneously execute instructions located side-by-side. For example, instructions like `MOVT R0, #0` and `ADD R0, PC, R0` cannot be executed simultaneously since they both modify the `R0` register. On the other hand, `MOVT R0, #0` and `MOV R2, #4` instructions can be executed simultaneously since the effects of their execution are not conflicting with each other. Presumably, the compiler tries to generate code in such a manner (wherever it is possible).

### Optimizing Xcode 4.6.3 (LLVM): Thumb-2 mode

```

__text:00002BA0          _printf_main2
__text:00002BA0
__text:00002BA0          var_1C = -0x1C
__text:00002BA0          var_18 = -0x18
__text:00002BA0          var_C = -0xC
__text:00002BA0
__text:00002BA0 80 B5          PUSH    {R7,LR}
__text:00002BA2 6F 46          MOV     R7, SP
__text:00002BA4 85 B0          SUB     SP, SP, #0x14
__text:00002BA6 41 F2 D8 20    MOVW   R0, #0x12D8
__text:00002BAA 4F F0 07 0C    MOV.W  R12, #7
__text:00002BAE C0 F2 00 00    MOVT.W R0, #0
__text:00002BB2 04 22          MOVS   R2, #4
__text:00002BB4 78 44          ADD    R0, PC ; char *
__text:00002BB6 06 23          MOVS   R3, #6
__text:00002BB8 05 21          MOVS   R1, #5
__text:00002BBA 0D F1 04 0E    ADD.W  LR, SP, #0x1C+var_18
__text:00002BBE 00 92          STR    R2, [SP,#0x1C+var_1C]
__text:00002BC0 4F F0 08 09    MOV.W  R9, #8
__text:00002BC4 8E E8 0A 10    STMIA.W LR, {R1,R3,R12}
__text:00002BC8 01 21          MOVS   R1, #1
__text:00002BCA 02 22          MOVS   R2, #2
__text:00002BCC 03 23          MOVS   R3, #3
__text:00002BCE CD F8 10 90    STR.W  R9, [SP,#0x1C+var_C]
__text:00002BD2 01 F0 0A EA    BLX   _printf
__text:00002BD6 05 B0          ADD    SP, SP, #0x14
__text:00002BD8 80 BD          POP    {R7,PC}

```

The output is almost the same as in the previous example, with the exception that Thumb-instructions are used instead.

## ARM64

### Non-optimizing GCC (Linaro) 4.9

Listing 1.57: Non-optimizing GCC (Linaro) 4.9

```

.LC2:
.string "a=%d; b=%d; c=%d; d=%d; e=%d; f=%d; g=%d; h=%d\n"
f3:
; grab more space in stack:
sub    sp, sp, #32
; save FP and LR in stack frame:
stp    x29, x30, [sp,16]
; set stack frame (FP=SP):
add    x29, sp, 16
adrp   x0, .LC2 ; "a=%d; b=%d; c=%d; d=%d; e=%d; f=%d; g=%d; h=%d\n"
add    x0, x0, :lo12:.LC2
mov    w1, 8 ; 9th argument
str    w1, [sp] ; store 9th argument in the stack
mov    w1, 1
mov    w2, 2
mov    w3, 3
mov    w4, 4
mov    w5, 5
mov    w6, 6
mov    w7, 7
bl     printf
sub    sp, x29, #16
; restore FP and LR
ldp    x29, x30, [sp,16]
add    sp, sp, 32
ret

```

The first 8 arguments are passed in X- or W-registers: [Procedure Call Standard for the ARM 64-bit Architecture (AArch64), (2013)]<sup>71</sup>. A string pointer requires a 64-bit register, so it's passed in X0. All other values have a *int* 32-bit type, so they are stored in the 32-bit part of the registers (W-). The 9th argument (8) is passed via the stack. Indeed: it's not possible to pass large number of arguments through registers, because the number of registers is limited.

Optimizing GCC (Linaro) 4.9 generates the same code.

### 1.11.3 MIPS

#### 3 arguments

#### Optimizing GCC 4.4.5

The main difference with the "Hello, world!" example is that in this case `printf()` is called instead of `puts()` and 3 more arguments are passed through the registers `$5...$7` (or `$A0...$A2`). That is why these registers are prefixed with A-, which implies they are used for function arguments passing.

Listing 1.58: Optimizing GCC 4.4.5 (assembly output)

```
$LC0:
    .ascii "a=%d; b=%d; c=%d\000"
main:
; function prologue:
    lui    $28,%hi(__gnu_local_gp)
    addiu  $sp,$sp,-32
    addiu  $28,$28,%lo(__gnu_local_gp)
    sw     $31,28($sp)
; load address of printf():
    lw     $25,%call16(printf)($28)
; load address of the text string and set 1st argument of printf():
    lui    $4,%hi($LC0)
    addiu  $4,$4,%lo($LC0)
; set 2nd argument of printf():
    li     $5,1                # 0x1
; set 3rd argument of printf():
    li     $6,2                # 0x2
; call printf():
    jalr   $25
; set 4th argument of printf() (branch delay slot):
    li     $7,3                # 0x3

; function epilogue:
    lw     $31,28($sp)
; set return value to 0:
    move   $2,$0
; return
    j      $31
    addiu  $sp,$sp,32 ; branch delay slot
```

Listing 1.59: Optimizing GCC 4.4.5 (IDA)

```
.text:00000000 main:
.text:00000000
.text:00000000 var_10      = -0x10
.text:00000000 var_4      = -4
.text:00000000
; function prologue:
.text:00000000          lui     $gp, (__gnu_local_gp >> 16)
.text:00000004          addiu  $sp, -0x20
.text:00000008          la     $gp, (__gnu_local_gp & 0xFFFF)
.text:0000000C          sw     $ra, 0x20+var_4($sp)
.text:00000010          sw     $gp, 0x20+var_10($sp)
; load address of printf():
.text:00000014          lw     $t9, (printf & 0xFFFF)($gp)
; load address of the text string and set 1st argument of printf():
.text:00000018          la     $a0, $LC0          # "a=%d; b=%d; c=%d"
; set 2nd argument of printf():
```

<sup>71</sup>Also available as <http://go.yurichev.com/17287>

```

.text:00000020      li      $a1, 1
; set 3rd argument of printf():
.text:00000024      li      $a2, 2
; call printf():
.text:00000028      jalr   $t9
; set 4th argument of printf() (branch delay slot):
.text:0000002C      li      $a3, 3
; function epilogue:
.text:00000030      lw     $ra, 0x20+var_4($sp)
; set return value to 0:
.text:00000034      move   $v0, $zero
; return
.text:00000038      jr     $ra
.text:0000003C      addiu  $sp, 0x20 ; branch delay slot

```

IDA has coalesced pair of LUI and ADDIU instructions into one LA pseudo instruction. That's why there are no instruction at address 0x1C: because LA *occupies* 8 bytes.

### Non-optimizing GCC 4.4.5

Non-optimizing GCC is more verbose:

Listing 1.60: Non-optimizing GCC 4.4.5 (assembly output)

```

$LC0:
    .ascii "a=%d; b=%d; c=%d\000"
main:
; function prologue:
    addiu $sp,$sp,-32
    sw    $31,28($sp)
    sw    $fp,24($sp)
    move  $fp,$sp
    lui   $28,%hi(__gnu_local_gp)
    addiu $28,$28,%lo(__gnu_local_gp)
; load address of the text string:
    lui   $2,%hi($LC0)
    addiu $2,$2,%lo($LC0)
; set 1st argument of printf():
    move  $4,$2
; set 2nd argument of printf():
    li    $5,1          # 0x1
; set 3rd argument of printf():
    li    $6,2          # 0x2
; set 4th argument of printf():
    li    $7,3          # 0x3
; get address of printf():
    lw    $2,%call16(printf)($28)
    nop
; call printf():
    move  $25,$2
    jalr  $25
    nop

; function epilogue:
    lw    $28,16($fp)
; set return value to 0:
    move  $2,$0
    move  $sp,$fp
    lw    $31,28($sp)
    lw    $fp,24($sp)
    addiu $sp,$sp,32
; return
    j     $31
    nop

```

Listing 1.61: Non-optimizing GCC 4.4.5 (IDA)

```

.text:00000000 main:
.text:00000000

```

```

.text:00000000 var_10      = -0x10
.text:00000000 var_8      = -8
.text:00000000 var_4      = -4
.text:00000000
; function prologue:
.text:00000000          addiu   $sp, -0x20
.text:00000004          sw     $ra, 0x20+var_4($sp)
.text:00000008          sw     $fp, 0x20+var_8($sp)
.text:0000000C          move   $fp, $sp
.text:00000010          la     $gp, __gnu_local_gp
.text:00000018          sw     $gp, 0x20+var_10($sp)
; load address of the text string:
.text:0000001C          la     $v0, aADBDCD      # "a=%d; b=%d; c=%d"
; set 1st argument of printf():
.text:00000024          move   $a0, $v0
; set 2nd argument of printf():
.text:00000028          li     $a1, 1
; set 3rd argument of printf():
.text:0000002C          li     $a2, 2
; set 4th argument of printf():
.text:00000030          li     $a3, 3
; get address of printf():
.text:00000034          lw     $v0, (printf & 0xFFFF)($gp)
.text:00000038          or     $at, $zero
; call printf():
.text:0000003C          move   $t9, $v0
.text:00000040          jalr   $t9
.text:00000044          or     $at, $zero ; NOP
; function epilogue:
.text:00000048          lw     $gp, 0x20+var_10($fp)
; set return value to 0:
.text:0000004C          move   $v0, $zero
.text:00000050          move   $sp, $fp
.text:00000054          lw     $ra, 0x20+var_4($sp)
.text:00000058          lw     $fp, 0x20+var_8($sp)
.text:0000005C          addiu   $sp, 0x20
; return
.text:00000060          jr     $ra
.text:00000064          or     $at, $zero ; NOP

```

## 8 arguments

Let's use again the example with 9 arguments from the previous section: [1.11.1 on page 51](#).

```

#include <stdio.h>

int main()
{
    printf("a=%d; b=%d; c=%d; d=%d; e=%d; f=%d; g=%d; h=%d\n", 1, 2, 3, 4, 5, 6, 7, 8);
    return 0;
};

```

## Optimizing GCC 4.4.5

Only the first 4 arguments are passed in the \$A0 ...\$A3 registers, the rest are passed via the stack.

This is the O32 calling convention (which is the most common one in the MIPS world). Other calling conventions (like N32) may use the registers for different purposes.

SW abbreviates "Store Word" (from register to memory). MIPS lacks instructions for storing a value into memory, so an instruction pair has to be used instead (LI/SW).

Listing 1.62: Optimizing GCC 4.4.5 (assembly output)

```

$LC0:
    .ascii "a=%d; b=%d; c=%d; d=%d; e=%d; f=%d; g=%d; h=%d\012\000"
main:
; function prologue:

```



```

    lui    $28,%hi(__gnu_local_gp)
    addiu  $sp,$sp,-56
    addiu  $28,$28,%lo(__gnu_local_gp)
    sw    $31,52($sp)
; pass 5th argument in stack:
    li    $2,4                # 0x4
    sw    $2,16($sp)
; pass 6th argument in stack:
    li    $2,5                # 0x5
    sw    $2,20($sp)
; pass 7th argument in stack:
    li    $2,6                # 0x6
    sw    $2,24($sp)
; pass 8th argument in stack:
    li    $2,7                # 0x7
    lw    $25,%call16(sprintf)($28)
    sw    $2,28($sp)
; pass 1st argument in $a0:
    lui   $4,%hi($LC0)
; pass 9th argument in stack:
    li    $2,8                # 0x8
    sw    $2,32($sp)
    addiu $4,$4,%lo($LC0)
; pass 2nd argument in $a1:
    li    $5,1                # 0x1
; pass 3rd argument in $a2:
    li    $6,2                # 0x2
; call sprintf():
    jalr  $25
; pass 4th argument in $a3 (branch delay slot):
    li    $7,3                # 0x3

; function epilogue:
    lw    $31,52($sp)
; set return value to 0:
    move  $2,$0
; return
    j     $31
    addiu $sp,$sp,56 ; branch delay slot

```

Listing 1.63: Optimizing GCC 4.4.5 (IDA)

```

.text:00000000 main:
.text:00000000
.text:00000000 var_28          = -0x28
.text:00000000 var_24          = -0x24
.text:00000000 var_20          = -0x20
.text:00000000 var_1C          = -0x1C
.text:00000000 var_18          = -0x18
.text:00000000 var_10          = -0x10
.text:00000000 var_4           = -4
.text:00000000
; function prologue:
.text:00000000                lui    $gp, (__gnu_local_gp >> 16)
.text:00000004                addiu  $sp, -0x38
.text:00000008                la     $gp, (__gnu_local_gp & 0xFFFF)
.text:0000000C                sw    $ra, 0x38+var_4($sp)
.text:00000010                sw    $gp, 0x38+var_10($sp)
; pass 5th argument in stack:
.text:00000014                li    $v0, 4
.text:00000018                sw    $v0, 0x38+var_28($sp)
; pass 6th argument in stack:
.text:0000001C                li    $v0, 5
.text:00000020                sw    $v0, 0x38+var_24($sp)
; pass 7th argument in stack:
.text:00000024                li    $v0, 6
.text:00000028                sw    $v0, 0x38+var_20($sp)
; pass 8th argument in stack:
.text:0000002C                li    $v0, 7
.text:00000030                lw    $t9, (sprintf & 0xFFFF)($gp)

```

```

.text:00000034      sw      $v0, 0x38+var_1C($sp)
; prepare 1st argument in $a0:
.text:00000038      lui     $a0, ($LC0 >> 16) # "a=%d; b=%d; c=%d; d=%d; e=%d; f=%d;
      g=%"..."
; pass 9th argument in stack:
.text:0000003C      li      $v0, 8
.text:00000040      sw      $v0, 0x38+var_18($sp)
; pass 1st argument in $a0:
.text:00000044      la      $a0, ($LC0 & 0xFFFF) # "a=%d; b=%d; c=%d; d=%d; e=%d;
      f=%d; g=%"..."
; pass 2nd argument in $a1:
.text:00000048      li      $a1, 1
; pass 3rd argument in $a2:
.text:0000004C      li      $a2, 2
; call printf():
.text:00000050      jalr   $t9
; pass 4th argument in $a3 (branch delay slot):
.text:00000054      li      $a3, 3
; function epilogue:
.text:00000058      lw      $ra, 0x38+var_4($sp)
; set return value to 0:
.text:0000005C      move   $v0, $zero
; return
.text:00000060      jr     $ra
.text:00000064      addiu  $sp, 0x38 ; branch delay slot

```

## Non-optimizing GCC 4.4.5

Non-optimizing GCC is more verbose:

Listing 1.64: Non-optimizing GCC 4.4.5 (assembly output)

```

$LC0:
      .ascii "a=%d; b=%d; c=%d; d=%d; e=%d; f=%d; g=%d; h=%d\012\000"
main:
; function prologue:
      addiu  $sp,$sp,-56
      sw     $31,52($sp)
      sw     $fp,48($sp)
      move   $fp,$sp
      lui   $28,%hi(__gnu_local_gp)
      addiu  $28,$28,%lo(__gnu_local_gp)
      lui   $2,%hi($LC0)
      addiu  $2,$2,%lo($LC0)
; pass 5th argument in stack:
      li     $3,4                # 0x4
      sw     $3,16($sp)
; pass 6th argument in stack:
      li     $3,5                # 0x5
      sw     $3,20($sp)
; pass 7th argument in stack:
      li     $3,6                # 0x6
      sw     $3,24($sp)
; pass 8th argument in stack:
      li     $3,7                # 0x7
      sw     $3,28($sp)
; pass 9th argument in stack:
      li     $3,8                # 0x8
      sw     $3,32($sp)
; pass 1st argument in $a0:
      move   $4,$2
; pass 2nd argument in $a1:
      li     $5,1                # 0x1
; pass 3rd argument in $a2:
      li     $6,2                # 0x2
; pass 4th argument in $a3:
      li     $7,3                # 0x3
; call printf():
      lw     $2,%call16(printf)($28)

```

```

    nop
    move    $25,$2
    jalr   $25
    nop
; function epilogue:
    lw     $28,40($fp)
; set return value to 0:
    move   $2,$0
    move   $sp,$fp
    lw     $31,52($sp)
    lw     $fp,48($sp)
    addiu  $sp,$sp,56
; return
    j      $31
    nop

```

Listing 1.65: Non-optimizing GCC 4.4.5 (IDA)

```

.text:00000000 main:
.text:00000000
.text:00000000 var_28          = -0x28
.text:00000000 var_24          = -0x24
.text:00000000 var_20          = -0x20
.text:00000000 var_1C          = -0x1C
.text:00000000 var_18          = -0x18
.text:00000000 var_10          = -0x10
.text:00000000 var_8           = -8
.text:00000000 var_4           = -4
.text:00000000
; function prologue:
.text:00000000          addiu   $sp, -0x38
.text:00000004          sw     $ra, 0x38+var_4($sp)
.text:00000008          sw     $fp, 0x38+var_8($sp)
.text:0000000C          move   $fp, $sp
.text:00000010          la     $gp, __gnu_local_gp
.text:00000018          sw     $gp, 0x38+var_10($sp)
.text:0000001C          la     $v0, aADBDCDDDEDFDGD # "a=%d; b=%d; c=%d; d=%d; e=%d;
    f=%d; g=%d"...
; pass 5th argument in stack:
.text:00000024          li     $v1, 4
.text:00000028          sw     $v1, 0x38+var_28($sp)
; pass 6th argument in stack:
.text:0000002C          li     $v1, 5
.text:00000030          sw     $v1, 0x38+var_24($sp)
; pass 7th argument in stack:
.text:00000034          li     $v1, 6
.text:00000038          sw     $v1, 0x38+var_20($sp)
; pass 8th argument in stack:
.text:0000003C          li     $v1, 7
.text:00000040          sw     $v1, 0x38+var_1C($sp)
; pass 9th argument in stack:
.text:00000044          li     $v1, 8
.text:00000048          sw     $v1, 0x38+var_18($sp)
; pass 1st argument in $a0:
.text:0000004C          move   $a0, $v0
; pass 2nd argument in $a1:
.text:00000050          li     $a1, 1
; pass 3rd argument in $a2:
.text:00000054          li     $a2, 2
; pass 4th argument in $a3:
.text:00000058          li     $a3, 3
; call printf():
.text:0000005C          lw     $v0, (printf & 0xFFFF)($gp)
.text:00000060          or     $at, $zero
.text:00000064          move   $t9, $v0
.text:00000068          jalr   $t9
.text:0000006C          or     $at, $zero ; NOP
; function epilogue:
.text:00000070          lw     $gp, 0x38+var_10($fp)
; set return value to 0:

```

```

.text:00000074      move    $v0, $zero
.text:00000078      move    $sp, $fp
.text:0000007C      lw      $ra, 0x38+var_4($sp)
.text:00000080      lw      $fp, 0x38+var_8($sp)
.text:00000084      addiu   $sp, 0x38
; return
.text:00000088      jr      $ra
.text:0000008C      or      $at, $zero ; NOP

```

### 1.11.4 Conclusion

Here is a rough skeleton of the function call:

Listing 1.66: x86

```

...
PUSH 3rd argument
PUSH 2nd argument
PUSH 1st argument
CALL function
; modify stack pointer (if needed)

```

Listing 1.67: x64 (MSVC)

```

MOV RCX, 1st argument
MOV RDX, 2nd argument
MOV R8, 3rd argument
MOV R9, 4th argument
...
PUSH 5th, 6th argument, etc. (if needed)
CALL function
; modify stack pointer (if needed)

```

Listing 1.68: x64 (GCC)

```

MOV RDI, 1st argument
MOV RSI, 2nd argument
MOV RDX, 3rd argument
MOV RCX, 4th argument
MOV R8, 5th argument
MOV R9, 6th argument
...
PUSH 7th, 8th argument, etc. (if needed)
CALL function
; modify stack pointer (if needed)

```

Listing 1.69: ARM

```

MOV R0, 1st argument
MOV R1, 2nd argument
MOV R2, 3rd argument
MOV R3, 4th argument
; pass 5th, 6th argument, etc., in stack (if needed)
BL function
; modify stack pointer (if needed)

```

Listing 1.70: ARM64

```

MOV X0, 1st argument
MOV X1, 2nd argument
MOV X2, 3rd argument

```

```

MOV X3, 4th argument
MOV X4, 5th argument
MOV X5, 6th argument
MOV X6, 7th argument
MOV X7, 8th argument
; pass 9th, 10th argument, etc., in stack (if needed)
BL function
; modify stack pointer (if needed)

```

Listing 1.71: MIPS (O32 calling convention)

```

LI $4, 1st argument ; AKA $A0
LI $5, 2nd argument ; AKA $A1
LI $6, 3rd argument ; AKA $A2
LI $7, 4th argument ; AKA $A3
; pass 5th, 6th argument, etc., in stack (if needed)
LW temp_reg, address of function
JALR temp_reg

```

### 1.11.5 By the way

By the way, this difference between the arguments passing in x86, x64, fastcall, ARM and MIPS is a good illustration of the fact that the CPU is oblivious to how the arguments are passed to functions. It is also possible to create a hypothetical compiler able to pass arguments via a special structure without using stack at all.

MIPS \$A0 ...\$A3 registers are labeled this way only for convenience (that is in the O32 calling convention). Programmers may use any other register (well, maybe except \$ZERO) to pass data or use any other calling convention.

The [CPU](#) is not aware of calling conventions whatsoever.

We may also recall how new coming assembly language programmers passing arguments into other functions: usually via registers, without any explicit order, or even via global variables. Of course, it works fine.

## 1.12 scanf()

Now let's use `scanf()`.

### 1.12.1 Simple example

```

#include <stdio.h>

int main()
{
    int x;
    printf ("Enter X:\n");

    scanf ("%d", &x);

    printf ("You entered %d...\n", x);

    return 0;
};

```

It's not clever to use `scanf()` for user interactions nowadays. But we can, however, illustrate passing a pointer to a variable of type `int`.

### About pointers

Pointers are one of the fundamental concepts in computer science. Often, passing a large array, structure or object as an argument to another function is too expensive, while passing their address is much cheaper. For example, if you going to print a text string to console, it's much easier to pass its address into [OS](#) kernel.

In addition if the [callee](#) function needs to modify something in the large array or structure received as a parameter and return back the entire structure then the situation is close to absurd. So the simplest thing to do is to pass the address of the array or structure to the [callee](#) function, and let it change what needs to be changed.

A pointer in C/C++—is simply an address of some memory location.

In x86, the address is represented as a 32-bit number (i.e., it occupies 4 bytes), while in x86-64 it is a 64-bit number (occupying 8 bytes). By the way, that is the reason behind some people’s indignation related to switching to x86-64—all pointers in the x64-architecture require twice as much space, including cache memory, which is “expensive” memory.

It is possible to work with untyped pointers only, given some effort; e.g. the standard C function `memcpy()`, that copies a block from one memory location to another, takes 2 pointers of type `void*` as arguments, since it is impossible to predict the type of the data you would like to copy. Data types are not important, only the block size matters.

Pointers are also widely used when a function needs to return more than one value (we are going to get back to this later ( [3.23 on page 600](#) ) ).

`scanf()` function—is such a case.

Besides the fact that the function needs to indicate how many values were successfully read, it also needs to return all these values.

In C/C++ the pointer type is only needed for compile-time type checking.

Internally, in the compiled code there is no information about pointer types at all.

## x86

## MSVC

Here is what we get after compiling with MSVC 2010:

```
CONST    SEGMENT
$SG3831  DB    'Enter X:', 0aH, 00H
$SG3832  DB    '%d', 00H
$SG3833  DB    'You entered %d...', 0aH, 00H
CONST    ENDS
PUBLIC   _main
EXTRN   _scanf:PROC
EXTRN   _printf:PROC
; Function compile flags: /Odtp
_TEXT   SEGMENT
_x$ = -4                                ; size = 4
_main   PROC
    push    ebp
    mov     ebp, esp
    push    ecx
    push    OFFSET $SG3831 ; 'Enter X:'
    call   _printf
    add     esp, 4
    lea    eax, DWORD PTR _x$[ebp]
    push    eax
    push    OFFSET $SG3832 ; '%d'
    call   _scanf
    add     esp, 8
    mov    ecx, DWORD PTR _x$[ebp]
    push    ecx
    push    OFFSET $SG3833 ; 'You entered %d...'
    call   _printf
    add     esp, 8

    ; return 0
    xor    eax, eax
    mov    esp, ebp
    pop    ebp
    ret    0
_main    ENDP
_TEXT    ENDS
```

x is a local variable.

According to the C/C++ standard it must be visible only in this function and not from any other external scope. Traditionally, local variables are stored on the stack. There are probably other ways to allocate them, but in x86 that is the way it is.

The goal of the instruction following the function prologue, `PUSH ECX`, is not to save the ECX state (notice the absence of corresponding `POP ECX` at the function's end).

In fact it allocates 4 bytes on the stack for storing the x variable.

x is to be accessed with the assistance of the `_x$` macro (it equals to -4) and the EBP register pointing to the current frame.

Over the span of the function's execution, EBP is pointing to the current [stack frame](#) making it possible to access local variables and function arguments via `EBP+offset`.

It is also possible to use ESP for the same purpose, although that is not very convenient since it changes frequently. The value of the EBP could be perceived as a *frozen state* of the value in ESP at the start of the function's execution.

Here is a typical [stack frame](#) layout in 32-bit environment:

...	...
EBP-8	local variable #2, marked in IDA as var_8
EBP-4	local variable #1, marked in IDA as var_4
EBP	saved value of EBP
EBP+4	return address
EBP+8	argument#1, marked in IDA as arg_0
EBP+0xC	argument#2, marked in IDA as arg_4
EBP+0x10	argument#3, marked in IDA as arg_8
...	...

The `scanf()` function in our example has two arguments.

The first one is a pointer to the string containing `%d` and the second is the address of the x variable.

First, the x variable's address is loaded into the EAX register by the `lea eax, DWORD PTR _x$[ebp]` instruction.

LEA stands for *load effective address*, and is often used for forming an address ([.1.6 on page 1029](#)).

We could say that in this case LEA simply stores the sum of the EBP register value and the `_x$` macro in the EAX register.

This is the same as `lea eax, [ebp-4]`.

So, 4 is being subtracted from the EBP register value and the result is loaded in the EAX register. Next the EAX register value is pushed into the stack and `scanf()` is being called.

`printf()` is being called after that with its first argument — a pointer to the string: `You entered %d... \n`.

The second argument is prepared with: `mov ecx, [ebp-4]`. The instruction stores the x variable value and not its address, in the ECX register.

Next the value in the ECX is stored on the stack and the last `printf()` is being called.

## MSVC + OllyDbg

Let's try this example in OllyDbg. Let's load it and keep pressing F8 (step over) until we reach our executable file instead of ntdll.dll. Scroll up until main() appears.

Click on the first instruction (PUSH EBP), press F2 (set a breakpoint), then F9 (Run). The breakpoint will be triggered when main() begins.

Let's trace to the point where the address of the variable *x* is calculated:

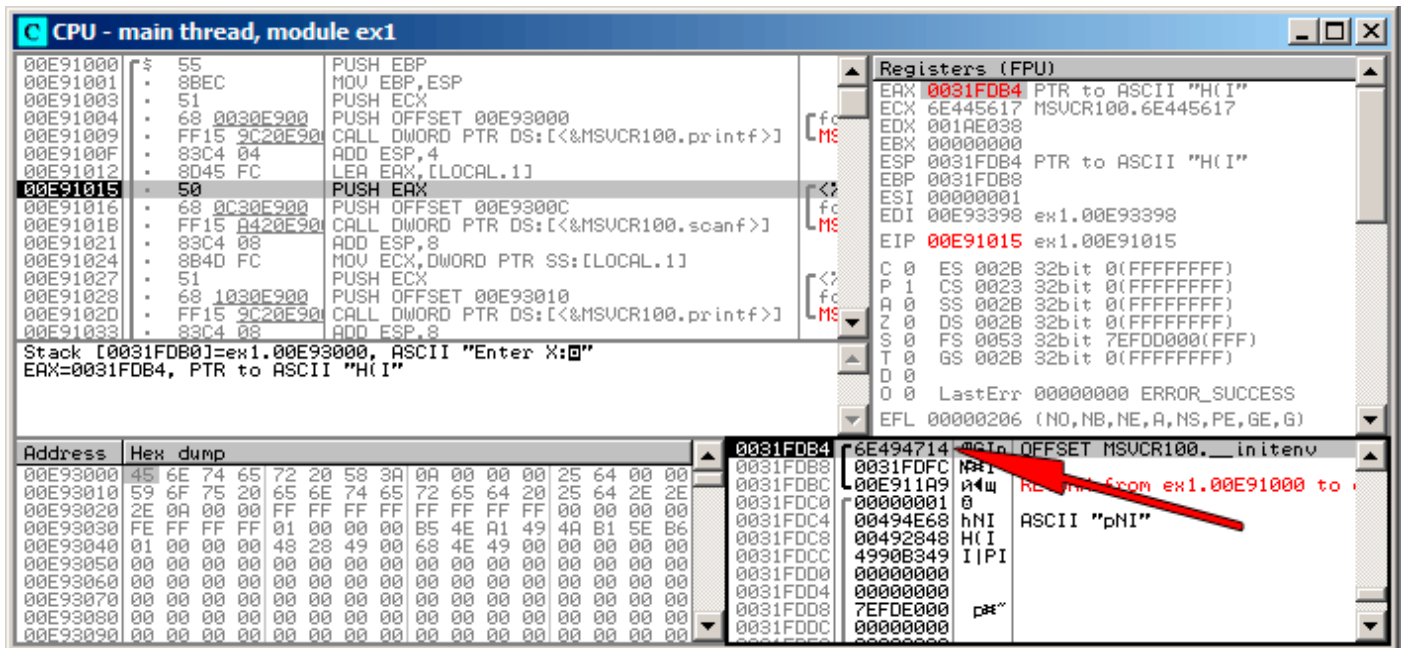

Figure 1.13: OllyDbg: The address of the local variable is calculated

Right-click the EAX in the registers window and then select "Follow in stack".

This address will appear in the stack window. The red arrow has been added, pointing to the variable in the local stack. At that moment this location contains some garbage (0x6E494714). Now with the help of PUSH instruction the address of this stack element is going to be stored to the same stack on the next position. Let's trace with F8 until the scanf() execution completes. During the scanf() execution, we input, for example, 123, in the console window:

```
Enter X:
123
```



scanf() completed its execution already:

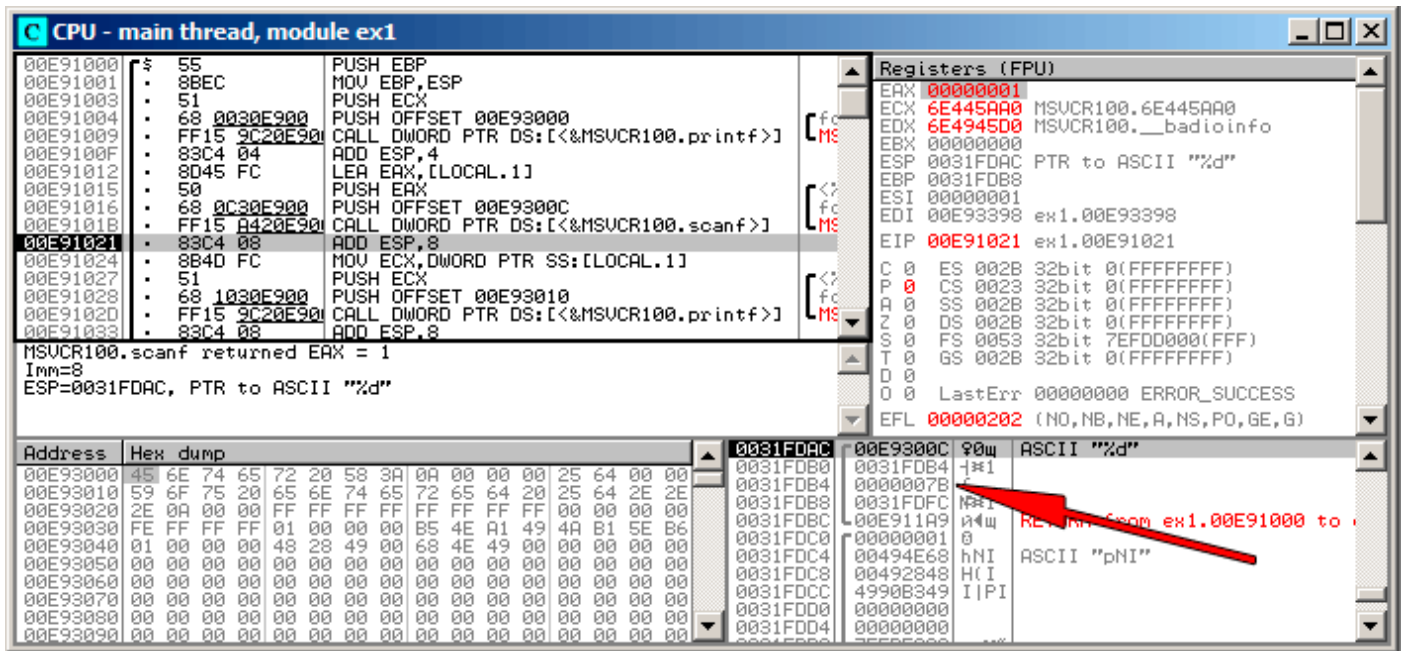

Figure 1.14: OllyDbg: scanf() executed

scanf() returns 1 in EAX, which implies that it has read successfully one value. If we look again at the stack element corresponding to the local variable it now contains 0x7B (123).

Later this value is copied from the stack to the ECX register and passed to printf():

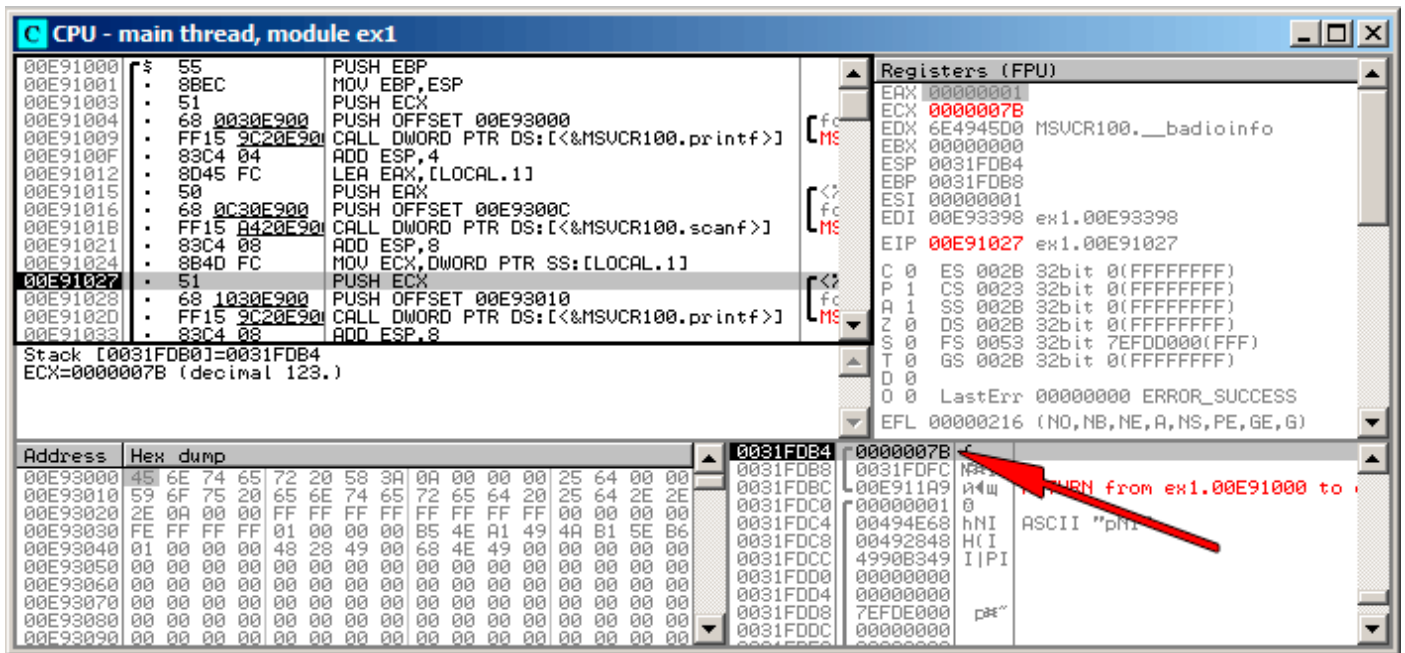

Figure 1.15: OllyDbg: preparing the value for passing to printf()

## GCC

Let's try to compile this code in GCC 4.4.1 under Linux:

```
main      proc near

var_20    = dword ptr -20h
var_1C    = dword ptr -1Ch
var_4     = dword ptr -4

        push    ebp
        mov     ebp, esp
        and     esp, 0FFFFFFF0h
        sub     esp, 20h
        mov     [esp+20h+var_20], offset aEnterX ; "Enter X:"
        call   _puts
        mov     eax, offset aD ; "%d"
        lea    edx, [esp+20h+var_4]
        mov     [esp+20h+var_1C], edx
        mov     [esp+20h+var_20], eax
        call   ___isoc99_scanf
        mov     edx, [esp+20h+var_4]
        mov     eax, offset aYouEnteredD___ ; "You entered %d...\n"
        mov     [esp+20h+var_1C], edx
        mov     [esp+20h+var_20], eax
        call   _printf
        mov     eax, 0
        leave
        retn
main      endp
```

GCC has replaced the printf() call with call to puts(). The reason for this was explained in ( 1.5.3 on page 20).

As in the MSVC example—the arguments are placed on the stack using the MOV instruction.

## By the way

This simple example is a demonstration of the fact that the compiler translates a list of expressions in C/C++-block into a sequential list of instructions. There is nothing in between expressions in C/C++, and so in the resulting machine code, there are nothing between, the control flow slips from one expression to the next one.

## x64

The picture here is similar with the difference that the registers, rather than the stack, are used for arguments passing.

## MSVC

Listing 1.72: MSVC 2012 x64

```
_DATA SEGMENT
$SG1289 DB 'Enter X:', 0aH, 00H
$SG1291 DB '%d', 00H
$SG1292 DB 'You entered %d...', 0aH, 00H
_DATA ENDS

_TEXT SEGMENT
x$ = 32
main PROC
$LN3:
    sub     rsp, 56
    lea    rcx, OFFSET FLAT:$SG1289 ; 'Enter X:'
    call   printf
    lea    rdx, QWORD PTR x$[rsp]
    lea    rcx, OFFSET FLAT:$SG1291 ; '%d'
    call   scanf
    mov    edx, DWORD PTR x$[rsp]
    lea    rcx, OFFSET FLAT:$SG1292 ; 'You entered %d...'
    call   printf

    ; return 0
    xor    eax, eax
    add    rsp, 56
    ret    0
main ENDP
_TEXT ENDS
```

## GCC

Listing 1.73: Optimizing GCC 4.4.6 x64

```
.LC0:
.string "Enter X:"
.LC1:
.string "%d"
.LC2:
.string "You entered %d...\n"

main:
    sub     rsp, 24
    mov     edi, OFFSET FLAT:.LC0 ; "Enter X:"
    call   puts
    lea    rsi, [rsp+12]
    mov     edi, OFFSET FLAT:.LC1 ; "%d"
    xor    eax, eax
    call   __isoc99_scanf
    mov     esi, DWORD PTR [rsp+12]
    mov     edi, OFFSET FLAT:.LC2 ; "You entered %d...\n"
    xor    eax, eax
    call   printf

    ; return 0
```

```

xor    eax, eax
add    rsp, 24
ret

```

## ARM

### Optimizing Keil 6/2013 (Thumb mode)

```

.text:00000042          scanf_main
.text:00000042
.text:00000042          var_8             = -8
.text:00000042
.text:00000042 08 B5          PUSH    {R3,LR}
.text:00000044 A9 A0          ADR     R0, aEnterX ; "Enter X:\n"
.text:00000046 06 F0 D3 F8    BL     __2printf
.text:0000004A 69 46          MOV     R1, SP
.text:0000004C AA A0          ADR     R0, aD ; "%d"
.text:0000004E 06 F0 CD F8    BL     __0scanf
.text:00000052 00 99          LDR     R1, [SP,#8+var_8]
.text:00000054 A9 A0          ADR     R0, aYouEnteredD___ ; "You entered %d...\n"
.text:00000056 06 F0 CB F8    BL     __2printf
.text:0000005A 00 20          MOVS   R0, #0
.text:0000005C 08 BD          POP     {R3,PC}

```

In order for `scanf()` to be able to read item it needs a parameter—pointer to an *int*. *int* is 32-bit, so we need 4 bytes to store it somewhere in memory, and it fits exactly in a 32-bit register. A place for the local variable `x` is allocated in the stack and **IDA** has named it `var_8`. It is not necessary, however, to allocate a such since **SP** (**stack pointer**) is already pointing to that space and it can be used directly.

So, **SP**'s value is copied to the **R1** register and, together with the format-string, passed to `scanf()`.

**PUSH/POP** instructions behaves differently in ARM than in x86 (it's the other way around). They are synonyms to **STM/STMDB/LDM/LDMIA** instructions. And **PUSH** instruction first writes a value into the stack, *and then* subtracts **SP** by 4. **POP** first adds 4 to **SP**, *and then* reads a value from the stack. Hence, after **PUSH**, **SP** points to an unused space in stack. It is used by `scanf()`, and by `printf()` after.

**LDMIA** means *Load Multiple Registers Increment address After each transfer*. **STMDB** means *Store Multiple Registers Decrement address Before each transfer*.

Later, with the help of the **LDR** instruction, this value is moved from the stack to the **R1** register in order to be passed to `printf()`.

## ARM64

Listing 1.74: Non-optimizing GCC 4.9.1 ARM64

```

1  .LC0:
2      .string "Enter X:"
3  .LC1:
4      .string "%d"
5  .LC2:
6      .string "You entered %d...\n"
7  scanf_main:
8      ; subtract 32 from SP, then save FP and LR in stack frame:
9          stp    x29, x30, [sp, -32]!
10     ; set stack frame (FP=SP)
11         add    x29, sp, 0
12     ; load pointer to the "Enter X:" string:
13         adrp   x0, .LC0
14         add    x0, x0, :lo12:LC0
15     ; X0=pointer to the "Enter X:" string
16     ; print it:
17         bl     puts
18     ; load pointer to the "%d" string:
19         adrp   x0, .LC1
20         add    x0, x0, :lo12:LC1
21     ; find a space in stack frame for "x" variable (X1=FP+28):

```

```

22     add    x1, x29, 28
23 ; X1=address of "x" variable
24 ; pass the address to scanf() and call it:
25     bl    __isoc99_scanf
26 ; load 32-bit value from the variable in stack frame:
27     ldr    w1, [x29,28]
28 ; W1=x
29 ; load pointer to the "You entered %d...\n" string
30 ; printf() will take text string from X0 and "x" variable from X1 (or W1)
31     adrp   x0, .LC2
32     add    x0, x0, :lo12:.LC2
33     bl    printf
34 ; return 0
35     mov    w0, 0
36 ; restore FP and LR, then add 32 to SP:
37     ldp    x29, x30, [sp], 32
38     ret

```

There is 32 bytes are allocated for stack frame, which is bigger than it needed. Perhaps some memory aligning issue? The most interesting part is finding space for the *x* variable in the stack frame (line 22). Why 28? Somehow, compiler decided to place this variable at the end of stack frame instead of beginning. The address is passed to `scanf()`, which just stores the user input value in the memory at that address. This is 32-bit value of type *int*. The value is fetched at line 27 and then passed to `printf()`.

## MIPS

A place in the local stack is allocated for the *x* variable, and it is to be referred as  $\$sp + 24$ .

Its address is passed to `scanf()`, and the user input values is loaded using the LW (“Load Word”) instruction and then passed to `printf()`.

Listing 1.75: Optimizing GCC 4.4.5 (assembly output)

```

$LC0:
    .ascii  "Enter X:\000"
$LC1:
    .ascii  "%d\000"
$LC2:
    .ascii  "You entered %d...\012\000"
main:
; function prologue:
    lui    $28,%hi(__gnu_local_gp)
    addiu  $sp,$sp,-40
    addiu  $28,$28,%lo(__gnu_local_gp)
    sw     $31,36($sp)
; call puts():
    lw     $25,%call16(puts)($28)
    lui    $4,%hi($LC0)
    jalr   $25
    addiu  $4,$4,%lo($LC0) ; branch delay slot
; call scanf():
    lw     $28,16($sp)
    lui    $4,%hi($LC1)
    lw     $25,%call16(__isoc99_scanf)($28)
; set 2nd argument of scanf(), $a1=$sp+24:
    addiu  $5,$sp,24
    jalr   $25
    addiu  $4,$4,%lo($LC1) ; branch delay slot

; call printf():
    lw     $28,16($sp)
; set 2nd argument of printf(),
; load word at address $sp+24:
    lw     $5,24($sp)
    lw     $25,%call16(printf)($28)
    lui    $4,%hi($LC2)
    jalr   $25
    addiu  $4,$4,%lo($LC2) ; branch delay slot

; function epilogue:

```

```

        lw      $31,36($sp)
; set return value to 0:
        move   $2,$0
; return:
        j      $31
        addiu  $sp,$sp,40      ; branch delay slot

```

IDA displays the stack layout as follows:

Listing 1.76: Optimizing GCC 4.4.5 (IDA)

```

.text:00000000 main:
.text:00000000
.text:00000000 var_18    = -0x18
.text:00000000 var_10    = -0x10
.text:00000000 var_4     = -4
.text:00000000
; function prologue:
.text:00000000          lui     $gp, (__gnu_local_gp >> 16)
.text:00000004          addiu   $sp, -0x28
.text:00000008          la      $gp, (__gnu_local_gp & 0xFFFF)
.text:0000000C          sw     $ra, 0x28+var_4($sp)
.text:00000010          sw     $gp, 0x28+var_18($sp)
; call puts():
.text:00000014          lw     $t9, (puts & 0xFFFF)($gp)
.text:00000018          lui   $a0, ($LC0 >> 16) # "Enter X:"
.text:0000001C          jalr  $t9
.text:00000020          la    $a0, ($LC0 & 0xFFFF) # "Enter X:" ; branch delay slot
; call scanf():
.text:00000024          lw     $gp, 0x28+var_18($sp)
.text:00000028          lui   $a0, ($LC1 >> 16) # "%d"
.text:0000002C          lw     $t9, (__isoc99_scanf & 0xFFFF)($gp)
; set 2nd argument of scanf(), $a1=$sp+24:
.text:00000030          addiu  $a1, $sp, 0x28+var_10
.text:00000034          jalr  $t9 ; branch delay slot
.text:00000038          la    $a0, ($LC1 & 0xFFFF) # "%d"
; call printf():
.text:0000003C          lw     $gp, 0x28+var_18($sp)
; set 2nd argument of printf(),
; load word at address $sp+24:
.text:00000040          lw     $a1, 0x28+var_10($sp)
.text:00000044          lw     $t9, (printf & 0xFFFF)($gp)
.text:00000048          lui   $a0, ($LC2 >> 16) # "You entered %d...\n"
.text:0000004C          jalr  $t9
.text:00000050          la    $a0, ($LC2 & 0xFFFF) # "You entered %d...\n" ; branch delay
slot
; function epilogue:
.text:00000054          lw     $ra, 0x28+var_4($sp)
; set return value to 0:
.text:00000058          move  $v0, $zero
; return:
.text:0000005C          jr   $ra
.text:00000060          addiu  $sp, 0x28 ; branch delay slot

```

## 1.12.2 The classic mistake

It's a very popular mistake (and/or typo) to pass a value of *x* instead of pointer to *x*:

```

#include <stdio.h>

int main()
{
    int x;
    printf ("Enter X:\n");

    scanf ("%d", x); // BUG

    printf ("You entered %d...\n", x);

    return 0;
}

```

```
};
```

So what happens here? `x` is not initialized and contains some random noise from local stack. When `scanf()` called, it takes string from user, parses it into number and tries to write it into `x`, treating it as an address in memory. But there is a random noise, so `scanf()` will try to write at random address. Most likely, the process will crash.

Interestingly enough, some [CRT](#) libraries in debug build, put visually distinctive patterns into memory just allocated, like `0xCCCCCCCC` or `0x0BADF00D` and so on. In this case, `x` may contain `0xCCCCCCCC`, and `scanf()` would try to write at address `0xCCCCCCCC`. And if you'll notice that something in your process tries to write at address `0xCCCCCCCC`, you'll know that uninitialized variable (or pointer) gets used without prior initialization. This is better than as if newly allocated memory is just cleared by zero bytes.

### 1.12.3 Global variables

What if the `x` variable from the previous example isn't local but a global one? Then it would have been accessible from any point, not only from the function body. Global variables are considered [anti-pattern](#), but for the sake of the experiment, we could do this.

```
#include <stdio.h>

// now x is global variable
int x;

int main()
{
    printf ("Enter X:\n");

    scanf ("%d", &x);

    printf ("You entered %d...\n", x);

    return 0;
};
```

### MSVC: x86

```
_DATA    SEGMENT
COMM    _x:DWORD
$SG2456  DB    'Enter X:', 0aH, 00H
$SG2457  DB    '%d', 00H
$SG2458  DB    'You entered %d...', 0aH, 00H
_DATA    ENDS
PUBLIC  _main
EXTRN  _scanf:PROC
EXTRN  _printf:PROC
; Function compile flags: /Odtp
_TEXT    SEGMENT
_main    PROC
    push    ebp
    mov     ebp, esp
    push    OFFSET $SG2456
    call    _printf
    add     esp, 4
    push    OFFSET _x
    push    OFFSET $SG2457
    call    _scanf
    add     esp, 8
    mov     eax, DWORD PTR _x
    push    eax
    push    OFFSET $SG2458
    call    _printf
    add     esp, 8
    xor     eax, eax
    pop     ebp
    ret     0
_main    ENDP
_TEXT    ENDS
```

In this case the `x` variable is defined in the `_DATA` segment and no memory is allocated in the local stack. It is accessed directly, not through the stack. Uninitialized global variables take no space in the executable file (indeed, why one needs to allocate space for variables initially set to zero?), but when someone accesses their address, the OS will allocate a block of zeros there<sup>72</sup>.

Now let's explicitly assign a value to the variable:

```
int x=10; // default value
```

We got:

```
_DATA  SEGMENT
_x      DD      0aH
...
```

Here we see a value `0xA` of `DWORD` type (`DD` stands for `DWORD` = 32 bit) for this variable.

If you open the compiled `.exe` in [IDA](#), you can see the `x` variable placed at the beginning of the `_DATA` segment, and after it you can see text strings.

If you open the compiled `.exe` from the previous example in [IDA](#), where the value of `x` hasn't been set, you would see something like this:

Listing 1.77: [IDA](#)

```
.data:0040FA80 _x          dd ?    ; DATA XREF: _main+10
.data:0040FA80          ; _main+22
.data:0040FA84 dword_40FA84  dd ?    ; DATA XREF: _memset+1E
.data:0040FA84          ; unknown_libname_1+28
.data:0040FA88 dword_40FA88  dd ?    ; DATA XREF: __sbh_find_block+5
.data:0040FA88          ; __sbh_free_block+2BC
.data:0040FA8C ; LPVOID lpMem
.data:0040FA8C lpMem      dd ?    ; DATA XREF: __sbh_find_block+B
.data:0040FA8C          ; __sbh_free_block+2CA
.data:0040FA90 dword_40FA90  dd ?    ; DATA XREF: _V6_HeapAlloc+13
.data:0040FA90          ; _calloc_impl+72
.data:0040FA94 dword_40FA94  dd ?    ; DATA XREF: __sbh_free_block+2FE
```

`_x` is marked with `?` with the rest of the variables that do not need to be initialized. This implies that after loading the `.exe` to the memory, a space for all these variables is to be allocated and filled with zeros [*ISO/IEC 9899:TC3 (C C99 standard)*, (2007)6.7.8p10]. But in the `.exe` file these uninitialized variables do not occupy anything. This is convenient for large arrays, for example.

<sup>72</sup>That is how a [VM](#) behaves



## MSVC: x86 + OllyDbg

Things are even simpler here:

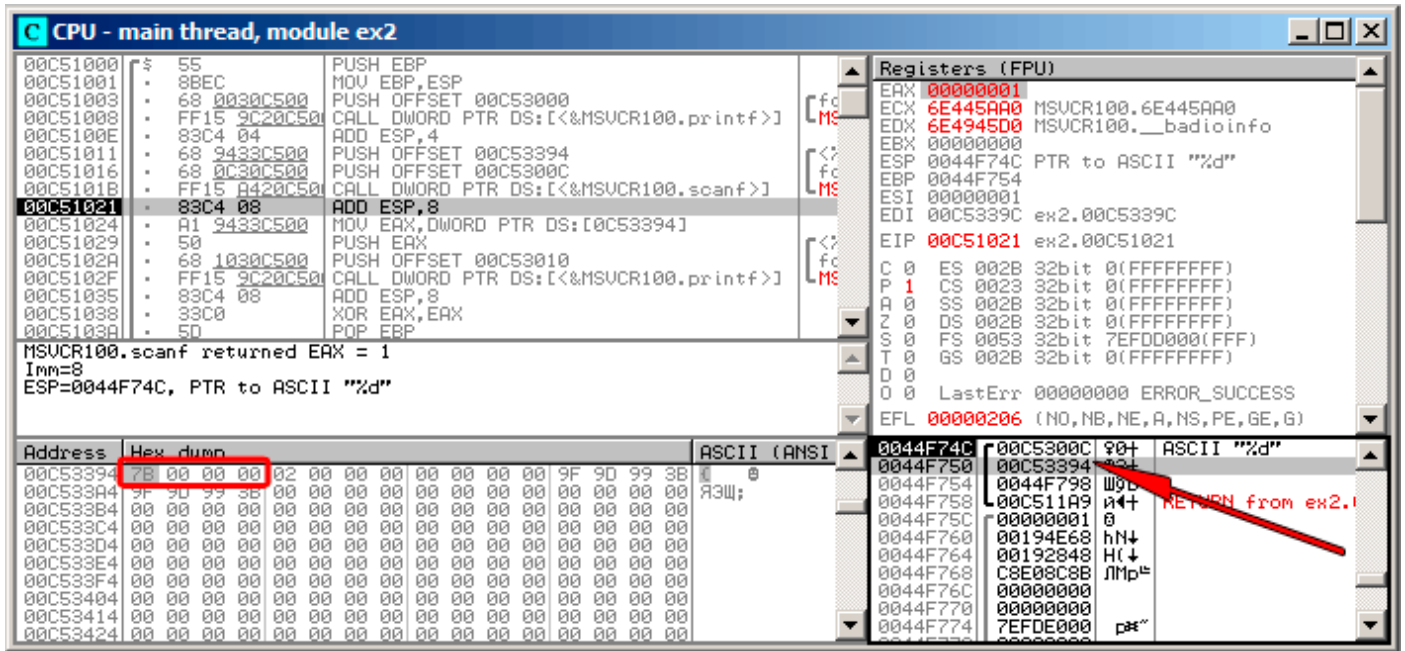

Figure 1.16: OllyDbg: after scanf () execution

The variable is located in the data segment. After the PUSH instruction (pushing the address of `x`) gets executed, the address appears in the stack window. Right-click on that row and select "Follow in dump". The variable will appear in the memory window on the left. After we have entered 123 in the console, 0x7B appears in the memory window (see the highlighted screenshot regions).

But why is the first byte 7B? Thinking logically, 00 00 00 7B must be there. The cause for this is referred as **endianness**, and x86 uses *little-endian*. This implies that the lowest byte is written first, and the highest written last. Read more about it at: [2.8 on page 464](#). Back to the example, the 32-bit value is loaded from this memory address into EAX and passed to printf().

The memory address of `x` is 0x00C53394.

In OllyDbg we can review the process memory map (Alt-M) and we can see that this address is inside the .data PE-segment of our program:

Address	Size	Owner	Section	Contains	Type	Access	Initial	Mapped as
00070000	00067000				Map	R	R	C:\Windows\System32\locale.nls
00190000	00005000			Heap	Priv	RW	RW	
00209000	00007000				Priv	RW	Gua: RW	Gua:
0044C000	00001000				Priv	RW	Gua: RW	Gua:
0044D000	00003000			Stack of main thread	Priv	RW	RW	
00590000	00007000				Priv	RW	RW	
00750000	0000C000			Default heap	Priv	RW	RW	
00C50000	00001000	ex2		PE header	Img	R	RWE	Cop:
00C51000	00001000	ex2	.text	Code	Img	R E	RWE	Cop:
00C52000	00001000	ex2	.rdata	Imports	Img	R	RWE	Cop:
00C53000	00001000	ex2	.data	Data	Img	RW	RWE	Cop:
00C54000	00001000	ex2	.reloc	Relocations	Img	R	RWE	Cop:
6E3E0000	00001000	MSUCR100		PE header	Img	R	RWE	Cop:
6E3E1000	000B2000	MSUCR100	.text	Code, imports, exports	Img	R E	RWE	Cop:
6E493000	00006000	MSUCR100	.data	Data	Img	RW	RWE	Cop:
6E499000	00001000	MSUCR100	.rsrc	Resources	Img	R	RWE	Cop:
6E49A000	00005000	MSUCR100	.reloc	Relocations	Img	R	RWE	Cop:
755D0000	00001000	Mod_755D		PE header	Img	R	RWE	Cop:
755D1000	00003000				Img	R E	RWE	Cop:
755D4000	00001000				Img	RW	RWE	Cop:
755D5000	00003000				Img	R	RWE	Cop:
755E0000	00001000	Mod_755E		PE header	Img	R	RWE	Cop:
755E1000	0004D000				Img	R E	RWE	Cop:
7562E000	00005000				Img	RW	RWE	Cop:
75633000	00009000				Img	R	RWE	Cop:
75640000	00001000	Mod_7564		PE header	Img	R	RWE	Cop:
75641000	00038000				Img	R E	RWE	Cop:
75679000	00002000				Img	RW	RWE	Cop:
7567B000	00004000				Img	R	RWE	Cop:
76F50000	00010000	kernel32		PE header	Img	R	RWE	Cop:
76F60000	000D0000	kernel32	.text	Code, imports, exports	Img	R E	RWE	Cop:
77030000	00010000	kernel32	.data	Data	Img	RW	RWE	Cop:
77040000	00010000	kernel32	.rsrc	Resources	Img	R	RWE	Cop:
77050000	0000B000	kernel32	.reloc	Relocations	Img	R	RWE	Cop:
77810000	00001000	KERNELBASE		PE header	Img	R	RWE	Cop:
77811000	00040000	KERNELBASE	.text	Code, imports, exports	Img	R E	RWE	Cop:
77851000	00002000	KERNELBASE	.data	Data	Img	RW	RWE	Cop:
77853000	00001000	KERNELBASE	.rsrc	Resources	Img	R	RWE	Cop:
77854000	00003000	KERNELBASE	.reloc	Relocations	Img	R	RWE	Cop:
77B20000	00001000	Mod_77B2		PE header	Img	R	RWE	Cop:
77B21000	00102000				Img	R E	RWE	Cop:
77C23000	0002F000				Img	R	RWE	Cop:
77C52000	0000C000				Img	RW	RWE	Cop:
77C5E000	0006B000				Img	R	RWE	Cop:
77D00000	00001000	ntdll		PE header	Img	R	RWE	Cop:
77D10000	000D6000	ntdll	.text	Code, exports	Img	R E	RWE	Cop:
77DF0000	00001000	ntdll	RT	Code	Img	R E	RWE	Cop:
77E00000	00009000	ntdll	.data	Data	Img	RW	RWE	Cop:

Figure 1.17: OllyDbg: process memory map

**GCC: x86**

The picture in Linux is near the same, with the difference that the uninitialized variables are located in the `_bss` segment. In [ELF<sup>73</sup>](#) file this segment has the following attributes:

```
; Segment type: Uninitialized
; Segment permissions: Read/Write
```

If you, however, initialize the variable with some value e.g. 10, it is to be placed in the `_data` segment, which has the following attributes:

```
; Segment type: Pure data
; Segment permissions: Read/Write
```

**MSVC: x64**

Listing 1.78: MSVC 2012 x64

```
_DATA SEGMENT
COMM x:DWORD
$SG2924 DB 'Enter X:', 0aH, 00H
$SG2925 DB '%d', 00H
$SG2926 DB 'You entered %d...', 0aH, 00H
```

<sup>73</sup> Executable File format widely used in \*NIX systems including Linux

```

_DATA   ENDS

_TEXT   SEGMENT
main    PROC
$LN3:

    sub     rsp, 40

    lea    rcx, OFFSET FLAT:$SG2924 ; 'Enter X:'
    call   printf
    lea    rdx, OFFSET FLAT:x
    lea    rcx, OFFSET FLAT:$SG2925 ; '%d'
    call   scanf
    mov    edx, DWORD PTR x
    lea    rcx, OFFSET FLAT:$SG2926 ; 'You entered %d...'
    call   printf

    ; return 0
    xor    eax, eax

    add    rsp, 40
    ret    0
main     ENDP
_TEXT   ENDS

```

The code is almost the same as in x86. Please note that the address of the *x* variable is passed to `scanf()` using a `LEA` instruction, while the variable's value is passed to the second `printf()` using a `MOV` instruction. `DWORD PTR`—is a part of the assembly language (no relation to the machine code), indicating that the variable data size is 32-bit and the `MOV` instruction has to be encoded accordingly.

## ARM: Optimizing Keil 6/2013 (Thumb mode)

Listing 1.79: IDA

```

.text:00000000 ; Segment type: Pure code
.text:00000000     AREA .text, CODE
...
.text:00000000 main
.text:00000000     PUSH     {R4,LR}
.text:00000002     ADR     R0, aEnterX ; "Enter X:\n"
.text:00000004     BL      __2printf
.text:00000008     LDR     R1, =x
.text:0000000A     ADR     R0, aD ; "%d"
.text:0000000C     BL      __0scanf
.text:00000010     LDR     R0, =x
.text:00000012     LDR     R1, [R0]
.text:00000014     ADR     R0, aYouEnteredD___ ; "You entered %d...\n"
.text:00000016     BL      __2printf
.text:0000001A     MOVS   R0, #0
.text:0000001C     POP     {R4,PC}
...
.text:00000020 aEnterX DCB "Enter X:",0xA,0 ; DATA XREF: main+2
.text:0000002A     DCB    0
.text:0000002B     DCB    0
.text:0000002C off_2C DCD x ; DATA XREF: main+8
.text:0000002C ; main+10
.text:00000030 aD DCB "%d",0 ; DATA XREF: main+A
.text:00000033     DCB    0
.text:00000034 aYouEnteredD___ DCB "You entered %d...",0xA,0 ; DATA XREF: main+14
.text:00000047     DCB    0
.text:00000047 ; .text ends
.text:00000047
...
.data:00000048 ; Segment type: Pure data
.data:00000048     AREA .data, DATA
.data:00000048 ; ORG 0x48
.data:00000048     EXPORT x
.data:00000048 x DCD 0xA ; DATA XREF: main+8
.data:00000048 ; main+10
.data:00000048 ; .data ends

```

So, the `x` variable is now global and for this reason located in another segment, namely the data segment (`.data`). One could ask, why are the text strings located in the code segment (`.text`) and `x` is located right here? Because it is a variable and by definition its value could change. Moreover it could possibly change often. While text strings has constant type, they will not be changed, so they are located in the `.text` segment.

The code segment might sometimes be located in a [ROM<sup>74</sup>](#) chip (keep in mind, we now deal with embedded microelectronics, and memory scarcity is common here), and changeable variables —in [RAM](#).

It is not very economical to store constant variables in RAM when you have ROM.

Furthermore, constant variables in RAM must be initialized, because after powering on, the RAM, obviously, contains random information.

Moving forward, we see a pointer to the `x` (`off_2C`) variable in the code segment, and that all operations with the variable occur via this pointer.

That is because the `x` variable could be located somewhere far from this particular code fragment, so its address must be saved somewhere in close proximity to the code.

The LDR instruction in Thumb mode can only address variables in a range of 1020 bytes from its location, and in ARM-mode —variables in range of  $\pm 4095$  bytes.

And so the address of the `x` variable must be located somewhere in close proximity, because there is no guarantee that the linker would be able to accommodate the variable somewhere nearby the code, it may well be even in an external memory chip!

One more thing: if a variable is declared as `const`, the Keil compiler allocates it in the `.constdata` segment. Perhaps thereafter, the linker could place this segment in ROM too, along with the code segment.

## ARM64

Listing 1.80: Non-optimizing GCC 4.9.1 ARM64

```
1      .comm    x,4,4
2  .LC0:
3      .string "Enter X:"
4  .LC1:
5      .string "%d"
6  .LC2:
7      .string "You entered %d...\n"
8  f5:
9      ; save FP and LR in stack frame:
10     stp     x29, x30, [sp, -16]!
11     ; set stack frame (FP=SP)
12     add     x29, sp, 0
13     ; load pointer to the "Enter X:" string:
14     adrp   x0, .LC0
15     add     x0, x0, :lo12:LC0
16     bl     puts
17     ; load pointer to the "%d" string:
18     adrp   x0, .LC1
19     add     x0, x0, :lo12:LC1
20     ; form address of x global variable:
21     adrp   x1, x
22     add     x1, x1, :lo12:x
23     bl     __isoc99_scanf
24     ; form address of x global variable again:
25     adrp   x0, x
26     add     x0, x0, :lo12:x
27     ; load value from memory at this address:
28     ldr    w1, [x0]
29     ; load pointer to the "You entered %d...\n" string:
30     adrp   x0, .LC2
31     add     x0, x0, :lo12:LC2
32     bl     printf
33     ; return 0
34     mov    w0, 0
35     ; restore FP and LR:
```

<sup>74</sup>Read-Only Memory

```

36     ldp    x29, x30, [sp], 16
37     ret

```

In this case the *x* variable is declared as global and its address is calculated using the ADRP/ADD instruction pair (lines 21 and 25).

## MIPS

### Uninitialized global variable

So now the *x* variable is global. Let's compile to executable file rather than object file and load it into IDA. IDA displays the *x* variable in the .sbss ELF section (remember the "Global Pointer"? [1.5.4 on page 24](#)), since the variable is not initialized at the start.

Listing 1.81: Optimizing GCC 4.4.5 (IDA)

```

.text:004006C0 main:
.text:004006C0
.text:004006C0 var_10      = -0x10
.text:004006C0 var_4       = -4
.text:004006C0
; function prologue:
.text:004006C0          lui    $gp, 0x42
.text:004006C4          addiu  $sp, -0x20
.text:004006C8          li    $gp, 0x418940
.text:004006CC          sw    $ra, 0x20+var_4($sp)
.text:004006D0          sw    $gp, 0x20+var_10($sp)
; call puts():
.text:004006D4          la    $t9, puts
.text:004006D8          lui  $a0, 0x40
.text:004006DC          jalr $t9 ; puts
.text:004006E0          la    $a0, aEnterX      # "Enter X:" ; branch delay slot
; call scanf():
.text:004006E4          lw    $gp, 0x20+var_10($sp)
.text:004006E8          lui  $a0, 0x40
.text:004006EC          la    $t9, __isoc99_scanf
; prepare address of x:
.text:004006F0          la    $a1, x
.text:004006F4          jalr $t9 ; __isoc99_scanf
.text:004006F8          la    $a0, aD           # "%d" ; branch delay slot
; call printf():
.text:004006FC          lw    $gp, 0x20+var_10($sp)
.text:00400700          lui  $a0, 0x40
; get address of x:
.text:00400704          la    $v0, x
.text:00400708          la    $t9, printf
; load value from "x" variable and pass it to printf() in $a1:
.text:0040070C          lw    $a1, (x - 0x41099C)($v0)
.text:00400710          jalr $t9 ; printf
.text:00400714          la    $a0, aYouEnteredD__ # "You entered %d...\n" ; branch
delay slot
; function epilogue:
.text:00400718          lw    $ra, 0x20+var_4($sp)
.text:0040071C          move $v0, $zero
.text:00400720          jr   $ra
.text:00400724          addiu $sp, 0x20 ; branch delay slot

...

.sbss:0041099C # Segment type: Uninitialized
.sbss:0041099C .sbss
.sbss:0041099C .globl x
.sbss:0041099C x: .space 4
.sbss:0041099C

```

IDA reduces the amount of information, so we'll also do a listing using objdump and comment it:

Listing 1.82: Optimizing GCC 4.4.5 (objdump)

```

1 004006c0 <main>:
2 ; function prologue:
3 4006c0:      3c1c0042      lui    gp,0x42
4 4006c4:      27bdffe0      addiu  sp,sp,-32
5 4006c8:      279c8940      addiu  gp,gp,-30400
6 4006cc:      afbf001c      sw     ra,28(sp)
7 4006d0:      afbc0010      sw     gp,16(sp)
8 ; call puts():
9 4006d4:      8f998034      lw     t9,-32716(gp)
10 4006d8:      3c040040      lui    a0,0x40
11 4006dc:      0320f809      jalr   t9
12 4006e0:      248408f0      addiu  a0,a0,2288 ; branch delay slot
13 ; call scanf():
14 4006e4:      8fbc0010      lw     gp,16(sp)
15 4006e8:      3c040040      lui    a0,0x40
16 4006ec:      8f998038      lw     t9,-32712(gp)
17 ; prepare address of x:
18 4006f0:      8f858044      lw     a1,-32700(gp)
19 4006f4:      0320f809      jalr   t9
20 4006f8:      248408fc      addiu  a0,a0,2300 ; branch delay slot
21 ; call printf():
22 4006fc:      8fbc0010      lw     gp,16(sp)
23 400700:      3c040040      lui    a0,0x40
24 ; get address of x:
25 400704:      8f828044      lw     v0,-32700(gp)
26 400708:      8f99803c      lw     t9,-32708(gp)
27 ; load value from "x" variable and pass it to printf() in $a1:
28 40070c:      8c450000      lw     a1,0(v0)
29 400710:      0320f809      jalr   t9
30 400714:      24840900      addiu  a0,a0,2304 ; branch delay slot
31 ; function epilogue:
32 400718:      8fbf001c      lw     ra,28(sp)
33 40071c:      00001021      move   v0,zero
34 400720:      03e00008      jr     ra
35 400724:      27bd0020      addiu  sp,sp,32 ; branch delay slot
36 ; pack of NOPs used for aligning next function start on 16-byte boundary:
37 400728:      00200825      move   at,at
38 40072c:      00200825      move   at,at

```

Now we see the *x* variable address is read from a 64KiB data buffer using GP and adding negative offset to it (line 18). More than that, the addresses of the three external functions which are used in our example (`puts()`, `scanf()`, `printf()`), are also read from the 64KiB global data buffer using GP (lines 9, 16 and 26). GP points to the middle of the buffer, and such offset suggests that all three function's addresses, and also the address of the *x* variable, are all stored somewhere at the beginning of that buffer. That make sense, because our example is tiny.

Another thing worth mentioning is that the function ends with two **NOPs** (`MOVE $AT, $AT` — an idle instruction), in order to align next function's start on 16-byte boundary.

## Initialized global variable

Let's alter our example by giving the *x* variable a default value:

```
int x=10; // default value
```

Now IDA shows that the *x* variable is residing in the `.data` section:

Listing 1.83: Optimizing GCC 4.4.5 (IDA)

```

.text:004006A0 main:
.text:004006A0
.text:004006A0 var_10      = -0x10
.text:004006A0 var_8       = -8
.text:004006A0 var_4       = -4
.text:004006A0
.text:004006A0      lui    $gp, 0x42
.text:004006A4      addiu  $sp, -0x20
.text:004006A8      li     $gp, 0x418930
.text:004006AC      sw     $ra, 0x20+var_4($sp)

```

```

.text:004006B0      sw      $s0, 0x20+var_8($sp)
.text:004006B4      sw      $gp, 0x20+var_10($sp)
.text:004006B8      la      $t9, puts
.text:004006BC      lui     $a0, 0x40
.text:004006C0      jalr   $t9 ; puts
.text:004006C4      la      $a0, aEnterX      # "Enter X:"
.text:004006C8      lw      $gp, 0x20+var_10($sp)
; prepare high part of x address:
.text:004006CC      lui     $s0, 0x41
.text:004006D0      la      $t9, __isoc99_scanf
.text:004006D4      lui     $a0, 0x40
; add low part of x address:
.text:004006D8      addiu  $a1, $s0, (x - 0x410000)
; now address of x is in $a1.
.text:004006DC      jalr   $t9 ; __isoc99_scanf
.text:004006E0      la      $a0, aD            # "%d"
.text:004006E4      lw      $gp, 0x20+var_10($sp)
; get a word from memory:
.text:004006E8      lw      $a1, x
; value of x is now in $a1.
.text:004006EC      la      $t9, printf
.text:004006F0      lui     $a0, 0x40
.text:004006F4      jalr   $t9 ; printf
.text:004006F8      la      $a0, aYouEnteredD___ # "You entered %d...\n"
.text:004006FC      lw      $ra, 0x20+var_4($sp)
.text:00400700      move   $v0, $zero
.text:00400704      lw      $s0, 0x20+var_8($sp)
.text:00400708      jr     $ra
.text:0040070C      addiu  $sp, 0x20

...

.data:00410920      .globl x
.data:00410920 x:      .word 0xA

```

Why not `.sdata`? Perhaps that this depends on some GCC option?

Nevertheless, now `x` is in `.data`, which is a general memory area, and we can take a look how to work with variables there.

The variable's address must be formed using a pair of instructions.

In our case those are LUI ("Load Upper Immediate") and ADDIU ("Add Immediate Unsigned Word").

Here is also the objdump listing for close inspection:

Listing 1.84: Optimizing GCC 4.4.5 (objdump)

```

004006a0 <main>:
4006a0: 3c1c0042      lui     gp,0x42
4006a4: 27bdffe0      addiu  sp,sp,-32
4006a8: 279c8930      addiu  gp,gp,-30416
4006ac: afbf001c      sw     ra,28(sp)
4006b0: afb00018      sw     s0,24(sp)
4006b4: afbc0010      sw     gp,16(sp)
4006b8: 8f998034      lw     t9,-32716(gp)
4006bc: 3c040040      lui     a0,0x40
4006c0: 0320f809      jalr   t9
4006c4: 248408d0      addiu  a0,a0,2256
4006c8: 8fbc0010      lw     gp,16(sp)
; prepare high part of x address:
4006cc: 3c100041      lui     s0,0x41
4006d0: 8f998038      lw     t9,-32712(gp)
4006d4: 3c040040      lui     a0,0x40
; add low part of x address:
4006d8: 26050920      addiu  a1,s0,2336
; now address of x is in $a1.
4006dc: 0320f809      jalr   t9
4006e0: 248408dc      addiu  a0,a0,2268
4006e4: 8fbc0010      lw     gp,16(sp)
; high part of x address is still in $s0.
; add low part to it and load a word from memory:

```

```

4006e8:      8e050920      lw      a1,2336(s0)
; value of x is now in $a1.
4006ec:      8f99803c      lw      t9,-32708(gp)
4006f0:      3c040040      lui     a0,0x40
4006f4:      0320f809      jalr   t9
4006f8:      248408e0      addiu  a0,a0,2272
4006fc:      8fbf001c      lw      ra,28(sp)
400700:      00001021      move   v0,zero
400704:      8fb00018      lw      s0,24(sp)
400708:      03e00008      jr      ra
40070c:      27bd0020      addiu  sp,sp,32

```

We see that the address is formed using LUI and ADDIU, but the high part of address is still in the \$S0 register, and it is possible to encode the offset in a LW (“Load Word”) instruction, so one single LW is enough to load a value from the variable and pass it to printf().

Registers holding temporary data are prefixed with T-, but here we also see some prefixed with S-, the contents of which must be preserved before use in other functions (i.e., saved somewhere).

That is why the value of \$S0 has been set at address 0x4006cc and has been used again at address 0x4006e8, after the scanf() call. The scanf() function does not change its value.

### 1.12.4 scanf()

As was noted before, it is slightly old-fashioned to use scanf() today. But if we have to, we have to check if scanf() finishes correctly without an error.

```

#include <stdio.h>

int main()
{
    int x;
    printf ("Enter X:\n");

    if (scanf ("%d", &x)==1)
        printf ("You entered %d...\n", x);
    else
        printf ("What you entered? Huh?\n");

    return 0;
};

```

By standard, the scanf()<sup>75</sup> function returns the number of fields it has successfully read.

In our case, if everything goes fine and the user enters a number scanf() returns 1, or in case of error (or EOF<sup>76</sup>) — 0.

Let’s add some C code to check the scanf() return value and print error message in case of an error.

This works as expected:

```

C:\...\>ex3.exe
Enter X:
123
You entered 123...

C:\...\>ex3.exe
Enter X:
ouch
What you entered? Huh?

```

### MSVC: x86

Here is what we get in the assembly output (MSVC 2010):

<sup>75</sup>scanf, wscanf: [MSDN](#)

<sup>76</sup>End of File



```

    lea    eax, DWORD PTR _x$[ebp]
    push  eax
    push  OFFSET $SG3833 ; '%d', 00H
    call  _scanf
    add   esp, 8
    cmp   eax, 1
    jne   SHORT $LN2@main
    mov   ecx, DWORD PTR _x$[ebp]
    push  ecx
    push  OFFSET $SG3834 ; 'You entered %d...', 0aH, 00H
    call  _printf
    add   esp, 8
    jmp   SHORT $LN1@main
$LN2@main:
    push  OFFSET $SG3836 ; 'What you entered? Huh?', 0aH, 00H
    call  _printf
    add   esp, 4
$LN1@main:
    xor   eax, eax

```

The **caller** function (`main()`) needs the **callee** function (`scanf()`) result, so the **callee** returns it in the EAX register.

We check it with the help of the instruction `CMP EAX, 1` (*CoMPare*). In other words, we compare the value in the EAX register with 1.

A JNE conditional jump follows the CMP instruction. JNE stands for *Jump if Not Equal*.

So, if the value in the EAX register is not equal to 1, the CPU will pass the execution to the address mentioned in the JNE operand, in our case `$LN2@main`. Passing the control to this address results in the CPU executing `printf()` with the argument `What you entered? Huh?`. But if everything is fine, the conditional jump is not be taken, and another `printf()` call is to be executed, with two arguments: `'You entered %d...'` and the value of `x`.

Since in this case the second `printf()` has not to be executed, there is a JMP preceding it (unconditional jump). It passes the control to the point after the second `printf()` and just before the `XOR EAX, EAX` instruction, which implements `return 0`.

So, it could be said that comparing a value with another is *usually* implemented by `CMP/Jcc` instruction pair, where *cc* is *condition code*. `CMP` compares two values and sets processor flags<sup>77</sup>. `Jcc` checks those flags and decides to either pass the control to the specified address or not.

This could sound paradoxical, but the `CMP` instruction is in fact `SUB` (subtract). All arithmetic instructions set processor flags, not just `CMP`. If we compare 1 and 1, `1-1` is 0 so the ZF flag would be set (meaning that the last result is 0). In no other circumstances ZF can be set, except when the operands are equal. JNE checks only the ZF flag and jumps only if it is not set. JNE is in fact a synonym for `JNZ` (*Jump if Not Zero*). Assembler translates both JNE and JNZ instructions into the same opcode. So, the `CMP` instruction can be replaced with a `SUB` instruction and almost everything will be fine, with the difference that `SUB` alters the value of the first operand. `CMP` is *SUB without saving the result, but affecting flags*.

## MSVC: x86: IDA

It is time to run **IDA** and try to do something in it. By the way, for beginners it is good idea to use `/MD` option in MSVC, which means that all these standard functions are not be linked with the executable file, but are to be imported from the `MSVCR*.DLL` file instead. Thus it will be easier to see which standard function are used and where.

While analyzing code in **IDA**, it is very helpful to leave notes for oneself (and others). In instance, analyzing this example, we see that `JNZ` is to be triggered in case of an error. So it is possible to move the cursor to the label, press “n” and rename it to “error”. Create another label—into “exit”. Here is my result:

```

.text:00401000 _main proc near
.text:00401000
.text:00401000 var_4 = dword ptr -4
.text:00401000 argc = dword ptr 8
.text:00401000 argv = dword ptr 0Ch
.text:00401000 envp = dword ptr 10h
.text:00401000

```

<sup>77</sup>x86 flags, see also: [wikipedia](https://en.wikipedia.org/wiki/x86_registers).

```

.text:00401000    push    ebp
.text:00401001    mov     ebp, esp
.text:00401003    push    ecx
.text:00401004    push    offset Format ; "Enter X:\n"
.text:00401009    call   ds:printf
.text:0040100F    add     esp, 4
.text:00401012    lea    eax, [ebp+var_4]
.text:00401015    push    eax
.text:00401016    push    offset aD ; "%d"
.text:0040101B    call   ds:scanf
.text:00401021    add     esp, 8
.text:00401024    cmp    eax, 1
.text:00401027    jnz    short error
.text:00401029    mov    ecx, [ebp+var_4]
.text:0040102C    push    ecx
.text:0040102D    push    offset aYou ; "You entered %d...\n"
.text:00401032    call   ds:printf
.text:00401038    add     esp, 8
.text:0040103B    jmp    short exit
.text:0040103D    error: ; CODE XREF: _main+27
.text:0040103D    push    offset aWhat ; "What you entered? Huh?\n"
.text:00401042    call   ds:printf
.text:00401048    add     esp, 4
.text:0040104B    exit: ; CODE XREF: _main+3B
.text:0040104B    xor    eax, eax
.text:0040104D    mov    esp, ebp
.text:0040104F    pop    ebp
.text:00401050    retn
.text:00401050    _main endp

```

Now it is slightly easier to understand the code. However, it is not a good idea to comment on every instruction.

You could also hide(collapse) parts of a function in [IDA](#). To do that mark the block, then press “-” on the numerical pad and enter the text to be displayed instead.

Let’s hide two blocks and give them names:

```

.text:00401000    _text segment para public 'CODE' use32
.text:00401000    assume cs:_text
.text:00401000    ;org 401000h
.text:00401000    ; ask for X
.text:00401012    ; get X
.text:00401024    cmp    eax, 1
.text:00401027    jnz    short error
.text:00401029    ; print result
.text:0040103B    jmp    short exit
.text:0040103D    error: ; CODE XREF: _main+27
.text:0040103D    push    offset aWhat ; "What you entered? Huh?\n"
.text:00401042    call   ds:printf
.text:00401048    add     esp, 4
.text:0040104B    exit: ; CODE XREF: _main+3B
.text:0040104B    xor    eax, eax
.text:0040104D    mov    esp, ebp
.text:0040104F    pop    ebp
.text:00401050    retn
.text:00401050    _main endp

```

To expand previously collapsed parts of the code, use “+” on the numerical pad.

By pressing "space", we can see how IDA represents a function as a graph:

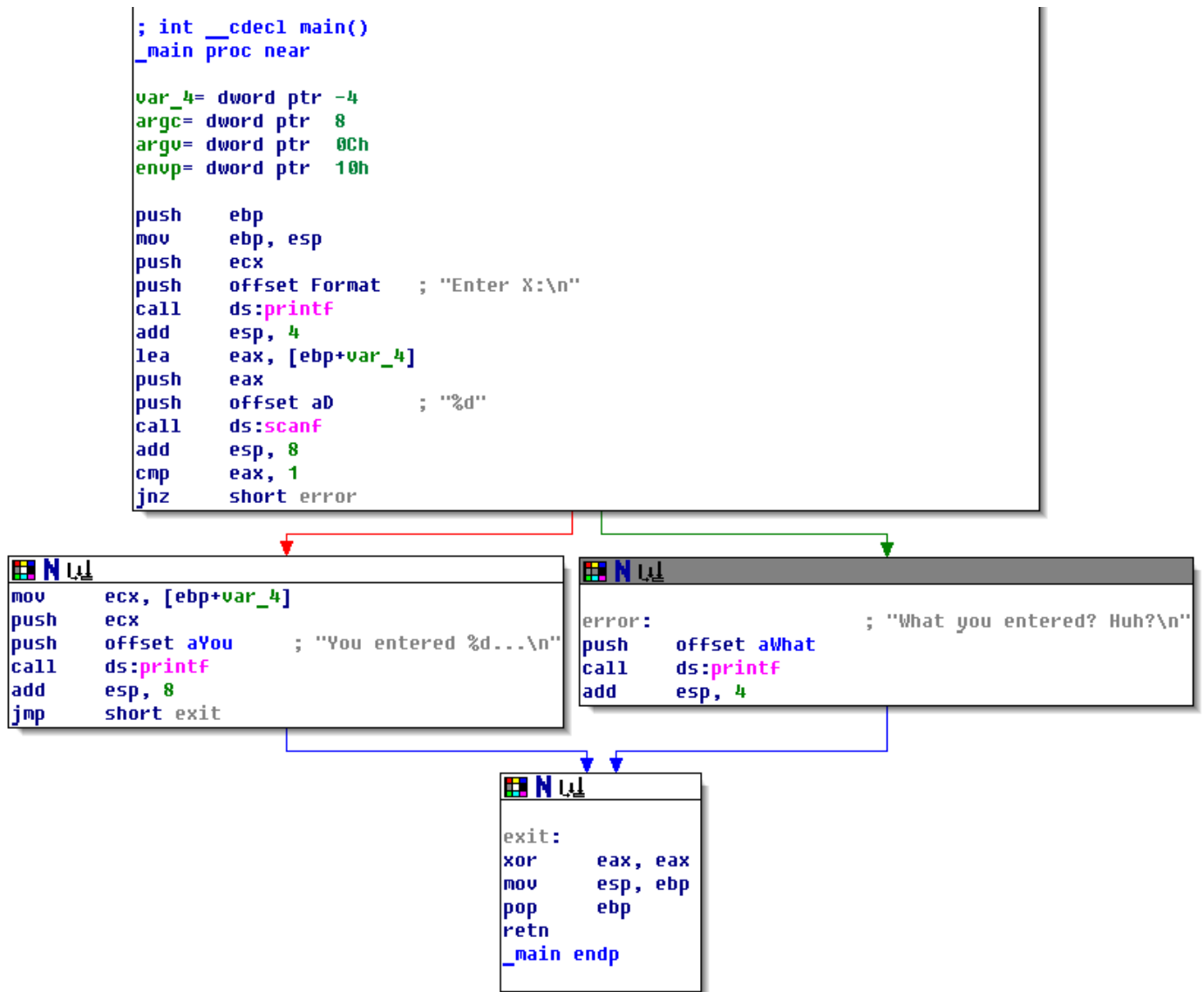

Figure 1.18: Graph mode in IDA

There are two arrows after each conditional jump: green and red. The green arrow points to the block which executes if the jump is triggered, and red if otherwise.

It is possible to fold nodes in this mode and give them names as well ("group nodes"). Let's do it for 3 blocks:

```
; int __cdecl main()
_main proc near

var_4= dword ptr -4
argc= dword ptr 8
argv= dword ptr 0Ch
envp= dword ptr 10h

push    ebp
mov     ebp, esp
push    ecx
push    offset Format    ; "Enter X:\n"
call   ds:printf
add     esp, 4
lea    eax, [ebp+var_4]
push    eax
push    offset aD        ; "%d"
call   ds:scanf
add     esp, 8
cmp    eax, 1
jnz    short error
```

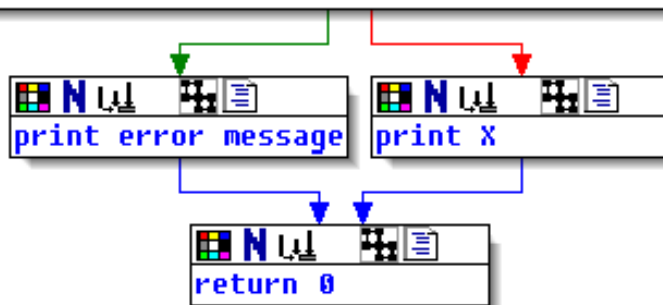

Figure 1.19: Graph mode in IDA with 3 nodes folded

That is very useful. It could be said that a very important part of the reverse engineers' job (and any other researcher as well) is to reduce the amount of information they deal with.

## MSVC: x86 + OllyDbg

Let's try to hack our program in OllyDbg, forcing it to think scanf() always works without error. When an address of a local variable is passed into scanf(), the variable initially contains some random garbage, in this case 0x6E494714:

The screenshot shows the CPU window for the main thread in module ex3. The assembly code at address 00321015 is highlighted, showing a call to scanf. The registers window shows EAX at 0042FBD4. The stack window shows the current stack frame with EAX=0042FBD4. The memory dump window shows the address 0042FB04 containing the value 6E494714, which is the address of a local variable passed to scanf(). A red arrow points to this value.

Address	Hex dump	ASCII (ANSI)
00323000	45 6E 74 65 72 20 58 3A 0A 00 00 00 25 64 00 00	Enter X:0
00323010	59 6F 75 20 65 6E 74 65 72 65 64 20 25 64 2E 2E	You entered
00323020	2E 0A 00 00 57 68 61 74 20 79 6F 75 20 65 6E 74	. What you
00323030	65 72 65 64 3F 20 48 75 68 3F 0A 00 FF FF FF FF	ered? Huh?
00323040	FF FF FF FF 00 00 00 00 00 00 00 00 00 00 00 00	
00323050	FE FF FF FF 01 00 00 00 10 05 05 22 E2 FA 2A 00	# 0 #F
00323060	01 00 00 00 48 28 17 00 68 4E 17 00 00 00 00 00	0 H( hN
00323070	00 00 00 00 00 00 00 00 00 00 00 00 00 00 00 00	
00323080	00 00 00 00 00 00 00 00 00 00 00 00 00 00 00 00	
00323090	00 00 00 00 00 00 00 00 00 00 00 00 00 00 00 00	

Figure 1.20: OllyDbg: passing variable address into scanf()

While scanf() executes, in the console we enter something that is definitely not a number, like "asdasd". scanf() finishes with 0 in EAX, which indicates that an error has occurred:

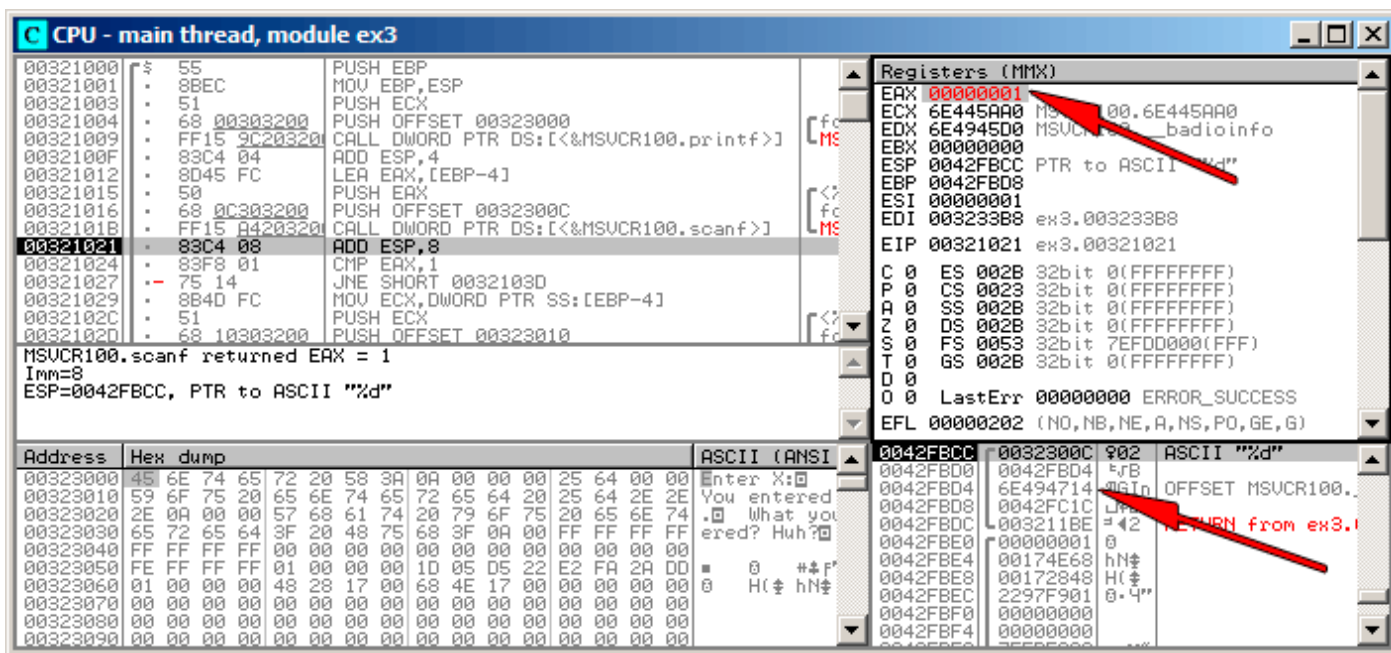

Figure 1.21: OllyDbg: scanf() returning error

We can also check the local variable in the stack and note that it has not changed. Indeed, what would scanf() write there? It simply did nothing except returning zero.

Let's try to "hack" our program. Right-click on EAX, Among the options there is "Set to 1". This is what we need.

We now have 1 in EAX, so the following check is to be executed as intended, and printf() will print the value of the variable in the stack.

When we run the program (F9) we can see the following in the console window:

Listing 1.85: console window

```
Enter X:
asdasd
You entered 1850296084...
```

Indeed, 1850296084 is a decimal representation of the number in the stack (0x6E494714)!

## MSVC: x86 + Hiew

This can also be used as a simple example of executable file patching. We may try to patch the executable so the program would always print the input, no matter what we enter.

Assuming that the executable is compiled against external MSVCR\*.DLL (i.e., with /MD option)<sup>78</sup>, we see the main() function at the beginning of the .text section. Let's open the executable in Hiew and find the beginning of the .text section (Enter, F8, F6, Enter, Enter).

We can see this:

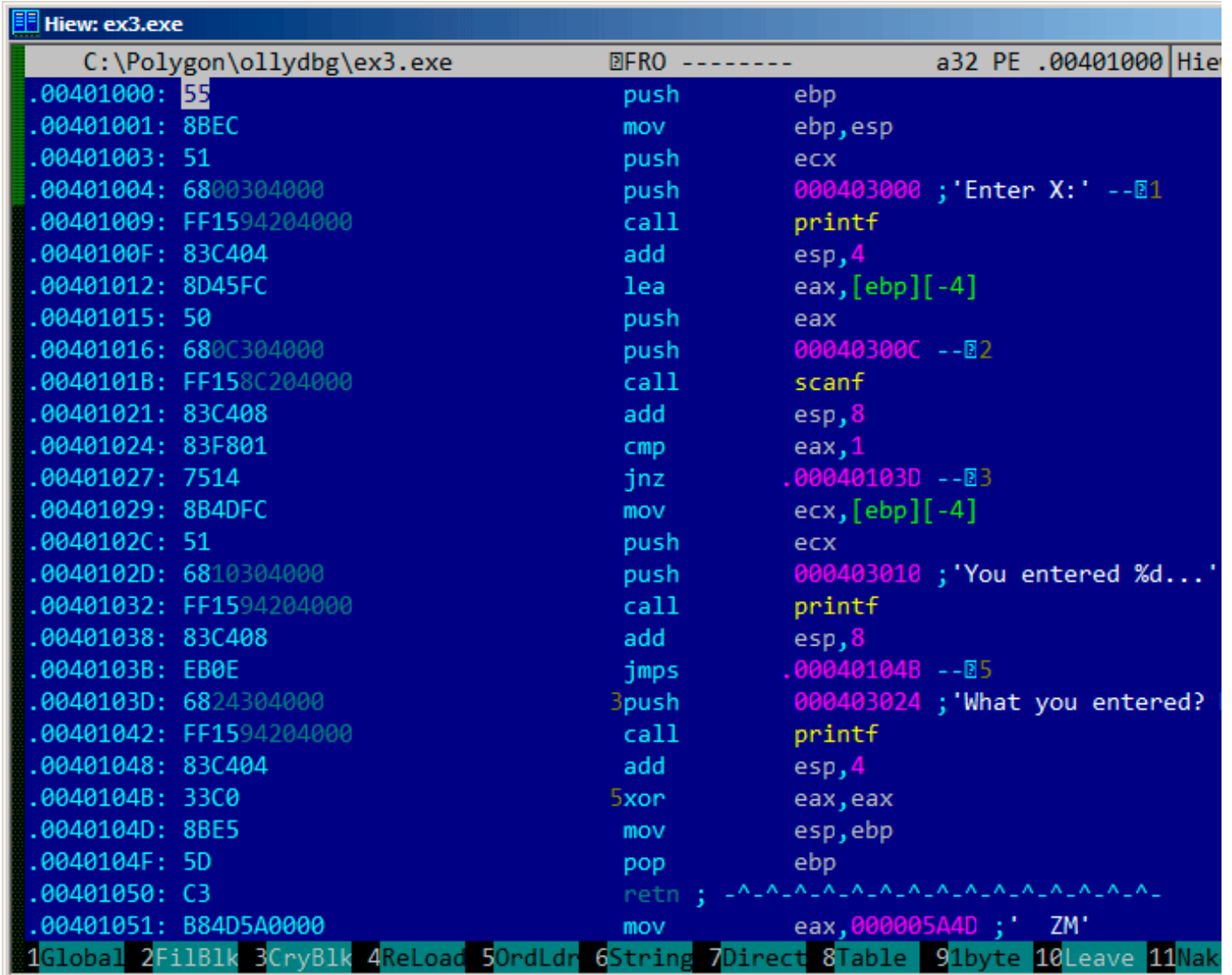

```
Hiew: ex3.exe
C:\Polygon\ollydbg\ex3.exe  FRO ----- a32 PE .00401000 Hie
.00401000: 55      push    ebp
.00401001: 8BEC    mov     ebp,esp
.00401003: 51      push    ecx
.00401004: 6800304000  push   000403000 ;'Enter X:' --[1]
.00401009: FF1594204000  call   printf
.0040100F: 83C404    add     esp,4
.00401012: 8D45FC    lea    eax,[ebp][-4]
.00401015: 50      push    eax
.00401016: 680C304000  push   00040300C --[2]
.0040101B: FF158C204000  call   scanf
.00401021: 83C408    add     esp,8
.00401024: 83F801    cmp     eax,1
.00401027: 7514     jnz    .0040103D --[3]
.00401029: 8B4DFC    mov     ecx,[ebp][-4]
.0040102C: 51      push    ecx
.0040102D: 6810304000  push   000403010 ;'You entered %d...'
.00401032: FF1594204000  call   printf
.00401038: 83C408    add     esp,8
.0040103B: EB0E     jmps   .0040104B --[5]
.0040103D: 6824304000  push   000403024 ;'What you entered?'
.00401042: FF1594204000  call   printf
.00401048: 83C404    add     esp,4
.0040104B: 33C0     xor     eax,eax
.0040104D: 8BE5     mov     esp,ebp
.0040104F: 5D      pop     ebp
.00401050: C3      retn   ; ^.^.^.^.^.^.^.^.^.^.^.^.^.^.^.^.^.^.^.^.^.^.^
.00401051: B84D5A0000  mov     eax,00005A4D ;' ZM'
1Global 2FilBlk 3CryBlk 4ReLoad 5OrdLdr 6String 7Direct 8Table 91byte 10Leave 11Nak
```

Figure 1.22: Hiew: main() function

Hiew finds ASCIIZ<sup>79</sup> strings and displays them, as it does with the imported functions' names.

<sup>78</sup>that's what also called "dynamic linking"

<sup>79</sup>ASCII Zero (null-terminated ASCII string )

Move the cursor to address .00401027 (where the JNZ instruction, we have to bypass, is located), press F3, and then type "9090" (meaning two NOPs):

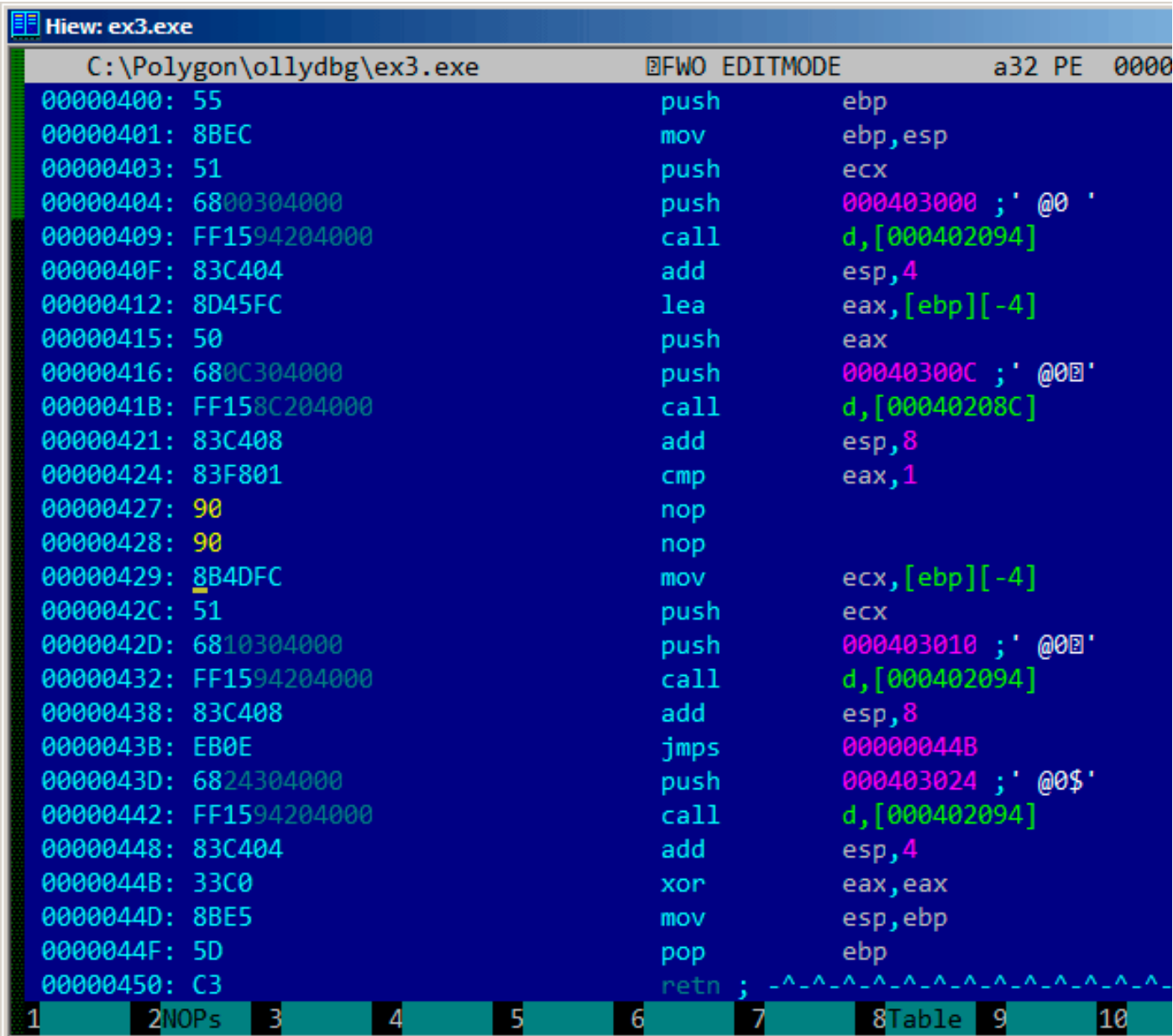

Figure 1.23: Hiew: replacing JNZ with two NOPs

Then press F9 (update). Now the executable is saved to the disk. It will behave as we wanted.

Two NOPs are probably not the most aesthetic approach. Another way to patch this instruction is to write just 0 to the second opcode byte (jump offset), so that JNZ will always jump to the next instruction.

We could also do the opposite: replace first byte with EB while not touching the second byte (jump offset). We would get an unconditional jump that is always triggered. In this case the error message would be printed every time, no matter the input.

**MSVC: x64**

Since we work here with int-typed variables, which are still 32-bit in x86-64, we see how the 32-bit part of the registers (prefixed with E-) are used here as well. While working with pointers, however, 64-bit register parts are used, prefixed with R-.

Listing 1.86: MSVC 2012 x64

```

_DATA SEGMENT
$SG2924 DB 'Enter X:', 0aH, 00H
$SG2926 DB '%d', 00H
  
```



```

$SG2927 DB      'You entered %d...', 0aH, 00H
$SG2929 DB      'What you entered? Huh?', 0aH, 00H
_DATA    ENDS

_TEXT    SEGMENT
x$ = 32
main     PROC
$LN5:
    sub     rsp, 56
    lea     rcx, OFFSET FLAT:$SG2924 ; 'Enter X:'
    call    printf
    lea     rdx, QWORD PTR x$[rsp]
    lea     rcx, OFFSET FLAT:$SG2926 ; '%d'
    call    scanf
    cmp     eax, 1
    jne     SHORT $LN2@main
    mov     edx, DWORD PTR x$[rsp]
    lea     rcx, OFFSET FLAT:$SG2927 ; 'You entered %d...'
    call    printf
    jmp     SHORT $LN1@main
$LN2@main:
    lea     rcx, OFFSET FLAT:$SG2929 ; 'What you entered? Huh?'
    call    printf
$LN1@main:
    ; return 0
    xor     eax, eax
    add     rsp, 56
    ret     0
main     ENDP
_TEXT    ENDS
END

```

## ARM

### ARM: Optimizing Keil 6/2013 (Thumb mode)

Listing 1.87: Optimizing Keil 6/2013 (Thumb mode)

```

var_8    = -8

    PUSH   {R3,LR}
    ADR    R0, aEnterX      ; "Enter X:\n"
    BL     __2printf
    MOV    R1, SP
    ADR    R0, aD           ; "%d"
    BL     __0scanf
    CMP    R0, #1
    BEQ    loc_1E
    ADR    R0, aWhatYouEntered ; "What you entered? Huh?\n"
    BL     __2printf

loc_1A   ; CODE XREF: main+26
    MOVS   R0, #0
    POP    {R3,PC}

loc_1E   ; CODE XREF: main+12
    LDR    R1, [SP,#8+var_8]
    ADR    R0, aYouEnteredD___ ; "You entered %d...\n"
    BL     __2printf
    B     loc_1A

```

The new instructions here are `CMP` and `BEQ`<sup>80</sup>.

`CMP` is analogous to the x86 instruction with the same name, it subtracts one of the arguments from the other and updates the conditional flags if needed.

<sup>80</sup>(PowerPC, ARM) Branch if Equal

**BEQ** jumps to another address if the operands were equal to each other, or, if the result of the last computation has been 0, or if the Z flag is 1. It behaves as JZ in x86.

Everything else is simple: the execution flow forks in two branches, then the branches converge at the point where 0 is written into the R0 as a function return value, and then the function ends.

## ARM64

Listing 1.88: Non-optimizing GCC 4.9.1 ARM64

```
1 .LC0:
2     .string "Enter X:"
3 .LC1:
4     .string "%d"
5 .LC2:
6     .string "You entered %d...\n"
7 .LC3:
8     .string "What you entered? Huh?"
9 f6:
10 ; save FP and LR in stack frame:
11     stp    x29, x30, [sp, -32]!
12 ; set stack frame (FP=SP)
13     add    x29, sp, 0
14 ; load pointer to the "Enter X:" string:
15     adrp   x0, .LC0
16     add    x0, x0, :lo12:LC0
17     bl     puts
18 ; load pointer to the "%d" string:
19     adrp   x0, .LC1
20     add    x0, x0, :lo12:LC1
21 ; calculate address of x variable in the local stack
22     add    x1, x29, 28
23     bl     __isoc99_scanf
24 ; scanf() returned result in W0.
25 ; check it:
26     cmp    w0, 1
27 ; BNE is Branch if Not Equal
28 ; so if W0<>0, jump to L2 will be occurred
29     bne    .L2
30 ; at this moment W0=1, meaning no error
31 ; load x value from the local stack
32     ldr    w1, [x29,28]
33 ; load pointer to the "You entered %d...\n" string:
34     adrp   x0, .LC2
35     add    x0, x0, :lo12:LC2
36     bl     printf
37 ; skip the code, which print the "What you entered? Huh?" string:
38     b     .L3
39 .L2:
40 ; load pointer to the "What you entered? Huh?" string:
41     adrp   x0, .LC3
42     add    x0, x0, :lo12:LC3
43     bl     puts
44 .L3:
45 ; return 0
46     mov    w0, 0
47 ; restore FP and LR:
48     ldp    x29, x30, [sp], 32
49     ret
```

Code flow in this case forks with the use of CMP/BNE (Branch if Not Equal) instructions pair.

## MIPS

Listing 1.89: Optimizing GCC 4.4.5 (IDA)

```
.text:004006A0 main:
.text:004006A0
.text:004006A0 var_18    = -0x18
```

```

.text:004006A0 var_10    = -0x10
.text:004006A0 var_4    = -4
.text:004006A0
.text:004006A0      lui    $gp, 0x42
.text:004006A4      addiu   $sp, -0x28
.text:004006A8      li     $gp, 0x418960
.text:004006AC      sw     $ra, 0x28+var_4($sp)
.text:004006B0      sw     $gp, 0x28+var_18($sp)
.text:004006B4      la     $t9, puts
.text:004006B8      lui    $a0, 0x40
.text:004006BC      jalr   $t9 ; puts
.text:004006C0      la     $a0, aEnterX      # "Enter X:"
.text:004006C4      lw     $gp, 0x28+var_18($sp)
.text:004006C8      lui    $a0, 0x40
.text:004006CC      la     $t9, __isoc99_scanf
.text:004006D0      la     $a0, aD           # "%d"
.text:004006D4      jalr   $t9 ; __isoc99_scanf
.text:004006D8      addiu   $a1, $sp, 0x28+var_10 # branch delay slot
.text:004006DC      li     $v1, 1
.text:004006E0      lw     $gp, 0x28+var_18($sp)
.text:004006E4      beq    $v0, $v1, loc_40070C
.text:004006E8      or     $at, $zero      # branch delay slot, NOP
.text:004006EC      la     $t9, puts
.text:004006F0      lui    $a0, 0x40
.text:004006F4      jalr   $t9 ; puts
.text:004006F8      la     $a0, aWhatYouEntered # "What you entered? Huh?"
.text:004006FC      lw     $ra, 0x28+var_4($sp)
.text:00400700      move   $v0, $zero
.text:00400704      jr     $ra
.text:00400708      addiu   $sp, 0x28

.text:0040070C loc_40070C:
.text:0040070C      la     $t9, printf
.text:00400710      lw     $a1, 0x28+var_10($sp)
.text:00400714      lui    $a0, 0x40
.text:00400718      jalr   $t9 ; printf
.text:0040071C      la     $a0, aYouEnteredD__ # "You entered %d...\n"
.text:00400720      lw     $ra, 0x28+var_4($sp)
.text:00400724      move   $v0, $zero
.text:00400728      jr     $ra
.text:0040072C      addiu   $sp, 0x28

```

scanf() returns the result of its work in register \$V0. It is checked at address 0x004006E4 by comparing the values in \$V0 with \$V1 (1 has been stored in \$V1 earlier, at 0x004006DC). BEQ stands for “Branch Equal”. If the two values are equal (i.e., success), the execution jumps to address 0x0040070C.

## Exercise

As we can see, the JNE/JNZ instruction can be easily replaced by the JE/JZ and vice versa (or BNE by BEQ and vice versa). But then the basic blocks must also be swapped. Try to do this in some of the examples.

### 1.12.5 Exercise

- <http://challenges.re/53>

## 1.13 Worth noting: global vs. local variables

Now that you know that global variables are filled with zeroes by OS at start ( 1.12.3 on page 78, [ISO/IEC 9899:TC3 (C C99 standard), (2007)6.7.8p10]), but local variables are not ( 1.9.4 on page 37).

Sometimes, you have a global variable that you forgot to initialize and your program relies on the fact that it has zero at start. Then you edit a program and move the global variable into a function to make it local. It wouldn't be zeroed at initialization anymore and this can result in nasty bugs.

## 1.14 Accessing passed arguments

Now we figured out that the **caller** function is passing arguments to the **callee** via the stack. But how does the **callee** access them?

Listing 1.90: simple example

```
#include <stdio.h>

int f (int a, int b, int c)
{
    return a*b+c;
};

int main()
{
    printf ("%d\n", f(1, 2, 3));
    return 0;
};
```

### 1.14.1 x86

#### MSVC

Here is what we get after compilation (MSVC 2010 Express):

Listing 1.91: MSVC 2010 Express

```
_TEXT  SEGMENT
_a$ = 8      ; size = 4
_b$ = 12     ; size = 4
_c$ = 16     ; size = 4
_f      PROC
    push    ebp
    mov     ebp, esp
    mov     eax, DWORD PTR _a$[ebp]
    imul   eax, DWORD PTR _b$[ebp]
    add    eax, DWORD PTR _c$[ebp]
    pop    ebp
    ret     0
_f      ENDP

_main   PROC
    push    ebp
    mov     ebp, esp
    push    3 ; 3rd argument
    push    2 ; 2nd argument
    push    1 ; 1st argument
    call   _f
    add    esp, 12
    push    eax
    push    OFFSET $SG2463 ; '%d', 0aH, 00H
    call   _printf
    add    esp, 8
    ; return 0
    xor    eax, eax
    pop    ebp
    ret     0
_main   ENDP
```

What we see is that the `main()` function pushes 3 numbers onto the stack and calls `f(int,int,int)`.

Argument access inside `f()` is organized with the help of macros like:

`_a$ = 8`, in the same way as local variables, but with positive offsets (addressed with *plus*). So, we are addressing the *outer* side of the **stack frame** by adding the `_a$` macro to the value in the EBP register.

Then the value of `a` is stored into EAX. After IMUL instruction execution, the value in EAX is a **product** of the value in EAX and the content of `_b`.

After that, ADD adds the value in `_c` to EAX.

The value in EAX does not need to be moved: it is already where it must be. On returning to [caller](#), it takes the EAX value and uses it as an argument to `printf()`.

## MSVC + OllyDbg

Let's illustrate this in OllyDbg. When we trace to the first instruction in `f()` that uses one of the arguments (first one), we see that EBP is pointing to the [stack frame](#), which is marked with a red rectangle.

The first element of the [stack frame](#) is the saved value of EBP, the second one is [RA](#), the third is the first function argument, then the second and third ones.

To access the first function argument, one needs to add exactly 8 (2 32-bit words) to EBP.

OllyDbg is aware about this, so it has added comments to the stack elements like

“RETURN from” and “Arg1 = ...”, etc.

N.B.: Function arguments are not members of the function's stack frame, they are rather members of the stack frame of the [caller](#) function.

Hence, OllyDbg marked “Arg” elements as members of another stack frame.

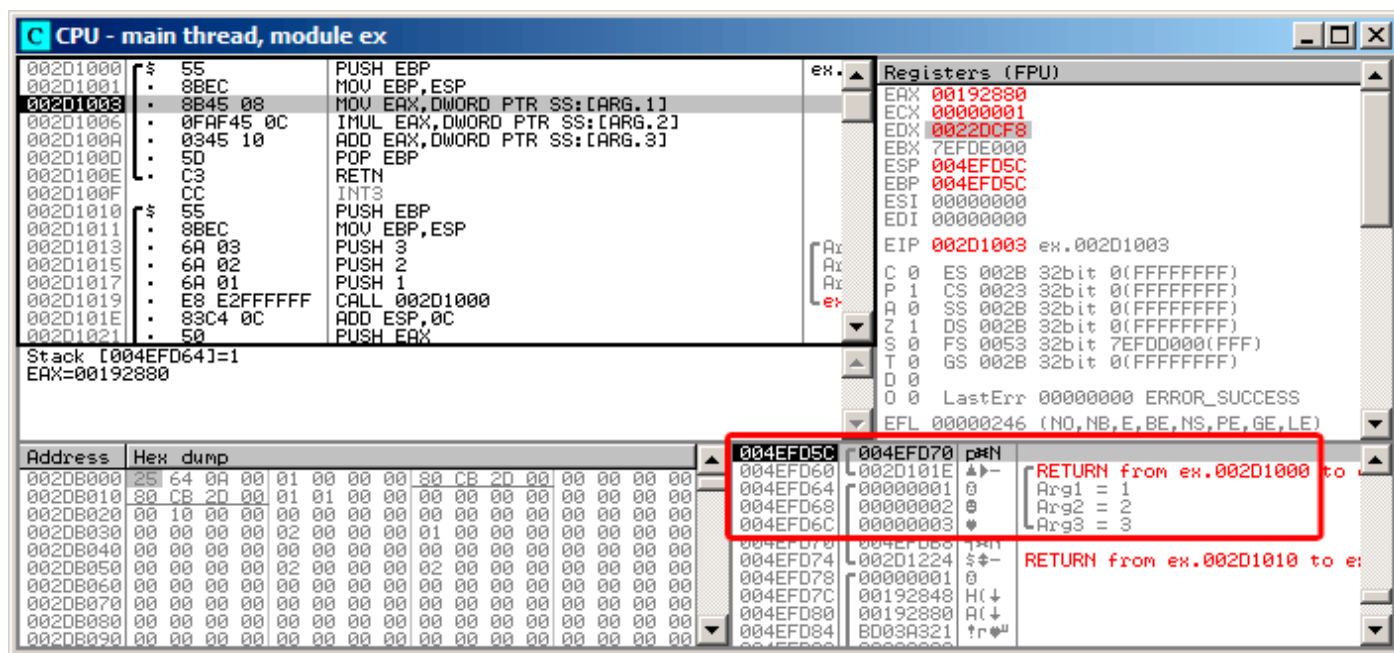

Figure 1.24: OllyDbg: inside of `f()` function

## GCC

Let's compile the same in GCC 4.4.1 and see the results in [IDA](#):

Listing 1.92: GCC 4.4.1

```

public f
f
proc near

arg_0 = dword ptr 8
arg_4 = dword ptr 0Ch
arg_8 = dword ptr 10h

push    ebp
mov     ebp, esp
mov     eax, [ebp+arg_0] ; 1st argument
imul   eax, [ebp+arg_4] ; 2nd argument
add    eax, [ebp+arg_8] ; 3rd argument
pop     ebp
retn

f
endp

public main

```

```

main    proc near

var_10  = dword ptr -10h
var_C   = dword ptr -0Ch
var_8   = dword ptr -8

        push    ebp
        mov     ebp, esp
        and     esp, 0FFFFFF0h
        sub     esp, 10h
        mov     [esp+10h+var_8], 3 ; 3rd argument
        mov     [esp+10h+var_C], 2 ; 2nd argument
        mov     [esp+10h+var_10], 1 ; 1st argument
        call    f
        mov     edx, offset aD ; "%d\n"
        mov     [esp+10h+var_C], eax
        mov     [esp+10h+var_10], edx
        call    _printf
        mov     eax, 0
        leave
        retn
main    endp

```

The result is almost the same with some minor differences discussed earlier.

The [stack pointer](#) is not set back after the two function calls(`f` and `printf`), because the penultimate `LEAVE` ([.1.6 on page 1029](#)) instruction takes care of this at the end.

### 1.14.2 x64

The story is a bit different in x86-64. Function arguments (first 4 or first 6 of them) are passed in registers i.e. the [callee](#) reads them from registers instead of reading them from the stack.

### MSVC

Optimizing MSVC:

Listing 1.93: Optimizing MSVC 2012 x64

```

$SG2997 DB    '%d', 0aH, 00H

main    PROC
        sub     rsp, 40
        mov     edx, 2
        lea    r8d, QWORD PTR [rdx+1] ; R8D=3
        lea    ecx, QWORD PTR [rdx-1] ; ECX=1
        call   f
        lea    rcx, OFFSET FLAT:$SG2997 ; '%d'
        mov     edx, eax
        call   printf
        xor     eax, eax
        add     rsp, 40
        ret     0
main    ENDP

f        PROC
        ; ECX - 1st argument
        ; EDX - 2nd argument
        ; R8D - 3rd argument
        imul   ecx, edx
        lea    eax, DWORD PTR [r8+rcx]
        ret     0
f        ENDP

```

As we can see, the compact function `f()` takes all its arguments from the registers.

The `LEA` instruction here is used for addition, apparently the compiler considered it faster than `ADD`.

LEA is also used in the `main()` function to prepare the first and third `f()` arguments. The compiler must have decided that this would work faster than the usual way of loading values into a register using `MOV` instruction.

Let's take a look at the non-optimizing MSVC output:

Listing 1.94: MSVC 2012 x64

```
f                proc near
; shadow space:
arg_0           = dword ptr  8
arg_8           = dword ptr 10h
arg_10          = dword ptr 18h

                ; ECX - 1st argument
                ; EDX - 2nd argument
                ; R8D - 3rd argument
                mov     [rsp+arg_10], r8d
                mov     [rsp+arg_8], edx
                mov     [rsp+arg_0], ecx
                mov     eax, [rsp+arg_0]
                imul   eax, [rsp+arg_8]
                add     eax, [rsp+arg_10]
                retn
f                endp

main            proc near
                sub     rsp, 28h
                mov     r8d, 3 ; 3rd argument
                mov     edx, 2 ; 2nd argument
                mov     ecx, 1 ; 1st argument
                call    f
                mov     edx, eax
                lea     rcx, $SG2931 ; "%d\n"
                call    printf

                ; return 0
                xor     eax, eax
                add     rsp, 28h
                retn
main            endp
```

It looks somewhat puzzling because all 3 arguments from the registers are saved to the stack for some reason. This is called “shadow space”<sup>81</sup>: every Win64 may (but is not required to) save all 4 register values there. This is done for two reasons: 1) it is too lavish to allocate a whole register (or even 4 registers) for an input argument, so it will be accessed via stack; 2) the debugger is always aware where to find the function arguments at a break<sup>82</sup>.

So, some large functions can save their input arguments in the “shadows space” if they want to use them during execution, but some small functions (like ours) may not do this.

It is a [caller](#) responsibility to allocate “shadow space” in the stack.

## GCC

Optimizing GCC generates more or less understandable code:

Listing 1.95: Optimizing GCC 4.4.6 x64

```
f:
                ; EDI - 1st argument
                ; ESI - 2nd argument
                ; EDX - 3rd argument
                imul   esi, edi
                lea     eax, [rdx+rsi]
                ret
```

<sup>81</sup>[MSDN](#)

<sup>82</sup>[MSDN](#)

```

main:
    sub    rsp, 8
    mov    edx, 3
    mov    esi, 2
    mov    edi, 1
    call   f
    mov    edi, OFFSET FLAT:.LC0 ; "%d\n"
    mov    esi, eax
    xor    eax, eax ; number of vector registers passed
    call   printf
    xor    eax, eax
    add    rsp, 8
    ret

```

Non-optimizing GCC:

Listing 1.96: GCC 4.4.6 x64

```

f:
    ; EDI - 1st argument
    ; ESI - 2nd argument
    ; EDX - 3rd argument
    push   rbp
    mov    rbp, rsp
    mov    DWORD PTR [rbp-4], edi
    mov    DWORD PTR [rbp-8], esi
    mov    DWORD PTR [rbp-12], edx
    mov    eax, DWORD PTR [rbp-4]
    imul  eax, DWORD PTR [rbp-8]
    add    eax, DWORD PTR [rbp-12]
    leave
    ret

main:
    push   rbp
    mov    rbp, rsp
    mov    edx, 3
    mov    esi, 2
    mov    edi, 1
    call   f
    mov    edx, eax
    mov    eax, OFFSET FLAT:.LC0 ; "%d\n"
    mov    esi, edx
    mov    rdi, rax
    mov    eax, 0 ; number of vector registers passed
    call   printf
    mov    eax, 0
    leave
    ret

```

There are no “shadow space” requirements in System V \*NIX ([Michael Matz, Jan Hubicka, Andreas Jaeger, Mark Mitchell, *System V Application Binary Interface. AMD64 Architecture Processor Supplement*, (2013)]<sup>83</sup>), but the **callee** may want to save its arguments somewhere in case of registers shortage.

### **GCC: uint64\_t instead of int**

Our example works with 32-bit *int*, that is why 32-bit register parts are used (prefixed by E-).

It can be altered slightly in order to use 64-bit values:

```

#include <stdio.h>
#include <stdint.h>

uint64_t f (uint64_t a, uint64_t b, uint64_t c)
{
    return a*b+c;
};

int main()

```

<sup>83</sup>Also available as <https://software.intel.com/sites/default/files/article/402129/mpx-linux64-abi.pdf>



```

{
    printf ("%lld\n", f(0x1122334455667788,
                       0x1111111122222222,
                       0x3333333344444444));
    return 0;
};

```

Listing 1.97: Optimizing GCC 4.4.6 x64

```

f      proc near
      imul   rsi, rdi
      lea   rax, [rdx+rsi]
      retn
f      endp

main   proc near
      sub    rsp, 8
      mov   rdx, 3333333344444444h ; 3rd argument
      mov   rsi, 1111111122222222h ; 2nd argument
      mov   rdi, 1122334455667788h ; 1st argument
      call  f
      mov   edi, offset format ; "%lld\n"
      mov   rsi, rax
      xor   eax, eax ; number of vector registers passed
      call  _printf
      xor   eax, eax
      add   rsp, 8
      retn
main   endp

```

The code is the same, but this time the *full size* registers (prefixed by R-) are used.

### 1.14.3 ARM

#### Non-optimizing Keil 6/2013 (ARM mode)

```

.text:000000A4 00 30 A0 E1      MOV     R3, R0
.text:000000A8 93 21 20 E0      MLA    R0, R3, R1, R2
.text:000000AC 1E FF 2F E1      BX     LR
...
.text:000000B0                main
.text:000000B0 10 40 2D E9      STMFD  SP!, {R4,LR}
.text:000000B4 03 20 A0 E3      MOV    R2, #3
.text:000000B8 02 10 A0 E3      MOV    R1, #2
.text:000000BC 01 00 A0 E3      MOV    R0, #1
.text:000000C0 F7 FF FF EB      BL     f
.text:000000C4 00 40 A0 E1      MOV    R4, R0
.text:000000C8 04 10 A0 E1      MOV    R1, R4
.text:000000CC 5A 0F 8F E2      ADR    R0, aD_0          ; "%d\n"
.text:000000D0 E3 18 00 EB      BL     __2printf
.text:000000D4 00 00 A0 E3      MOV    R0, #0
.text:000000D8 10 80 BD E8      LDMFD  SP!, {R4,PC}

```

The `main()` function simply calls two other functions, with three values passed to the first one —(`f()`).

As was noted before, in ARM the first 4 values are usually passed in the first 4 registers (R0-R3).

The `f()` function, as it seems, uses the first 3 registers (R0-R2) as arguments.

The `MLA` (*Multiply Accumulate*) instruction multiplies its first two operands (R3 and R1), adds the third operand (R2) to the product and stores the result into the zeroth register (R0), via which, by standard, functions return values.

Multiplication and addition at once (*Fused multiply-add*) is a very useful operation. By the way, there was no such instruction in x86 before FMA-instructions appeared in SIMD <sup>84</sup>.

The very first `MOV R3, R0` instruction is, apparently, redundant (a single `MLA` instruction could be used here instead). The compiler has not optimized it, since this is non-optimizing compilation.

<sup>84</sup>[wikipedia](#)

The BX instruction returns the control to the address stored in the LR register and, if necessary, switches the processor mode from Thumb to ARM or vice versa. This can be necessary since, as we can see, function f() is not aware from what kind of code it may be called, ARM or Thumb. Thus, if it gets called from Thumb code, BX is not only returns control to the calling function, but also switches the processor mode to Thumb. Or not switch, if the function has been called from ARM code [ARM(R) Architecture Reference Manual, ARMv7-A and ARMv7-R edition, (2012)A2.3.2].

### Optimizing Keil 6/2013 (ARM mode)

```
.text:00000098          f
.text:00000098 91 20 20 E0      MLA      R0, R1, R0, R2
.text:0000009C 1E FF 2F E1      BX       LR
```

And here is the f() function compiled by the Keil compiler in full optimization mode (-O3).

The MOV instruction was optimized out (or reduced) and now MLA uses all input registers and also places the result right into R0, exactly where the calling function will read and use it.

### Optimizing Keil 6/2013 (Thumb mode)

```
.text:0000005E 48 43          MULS    R0, R1
.text:00000060 80 18          ADDS    R0, R0, R2
.text:00000062 70 47          BX      LR
```

The MLA instruction is not available in Thumb mode, so the compiler generates the code doing these two operations (multiplication and addition) separately.

First the MULS instruction multiplies R0 by R1, leaving the result in register R0. The second instruction (ADDS) adds the result and R2 leaving the result in register R0.

## ARM64

### Optimizing GCC (Linaro) 4.9

Everything here is simple. MADD is just an instruction doing fused multiply/add (similar to the MLA we already saw). All 3 arguments are passed in the 32-bit parts of X-registers. Indeed, the argument types are 32-bit int's. The result is returned in W0.

Listing 1.98: Optimizing GCC (Linaro) 4.9

```
f:
    madd    w0, w0, w1, w2
    ret

main:
; save FP and LR to stack frame:
    stp    x29, x30, [sp, -16]!
    mov    w2, 3
    mov    w1, 2
    add    x29, sp, 0
    mov    w0, 1
    bl     f
    mov    w1, w0
    adrp   x0, .LC7
    add    x0, x0, :lo12:LC7
    bl     printf
; return 0
    mov    w0, 0
; restore FP and LR
    ldp    x29, x30, [sp], 16
    ret

.LC7:
    .string "%d\n"
```

Let's also extend all data types to 64-bit uint64\_t and test:

```

#include <stdio.h>
#include <stdint.h>

uint64_t f (uint64_t a, uint64_t b, uint64_t c)
{
    return a*b+c;
};

int main()
{
    printf ("%lld\n", f(0x1122334455667788,
                       0x1111111122222222,
                       0x3333333344444444));
    return 0;
};

```

```

f:
    madd    x0, x0, x1, x2
    ret

main:
    mov     x1, 13396
    adrp   x0, .LC8
    stp    x29, x30, [sp, -16]!
    movk   x1, 0x27d0, lsl 16
    add    x0, x0, :lo12:.LC8
    movk   x1, 0x122, lsl 32
    add    x29, sp, 0
    movk   x1, 0x58be, lsl 48
    bl     printf
    mov    w0, 0
    ldp    x29, x30, [sp], 16
    ret

.LC8:
    .string "%lld\n"

```

The f() function is the same, only the whole 64-bit X-registers are now used. Long 64-bit values are loaded into the registers by parts, this is also described here: [1.39.3 on page 441](#).

## Non-optimizing GCC (Linaro) 4.9

The non-optimizing compiler is more redundant:

```

f:
    sub    sp, sp, #16
    str    w0, [sp,12]
    str    w1, [sp,8]
    str    w2, [sp,4]
    ldr    w1, [sp,12]
    ldr    w0, [sp,8]
    mul    w1, w1, w0
    ldr    w0, [sp,4]
    add    w0, w1, w0
    add    sp, sp, 16
    ret

```

The code saves its input arguments in the local stack, in case someone (or something) in this function needs using the W0...W2 registers. This prevents overwriting the original function arguments, which may be needed again in the future.

This is called *Register Save Area*. ([*Procedure Call Standard for the ARM 64-bit Architecture (AArch64)*, (2013)]<sup>85</sup>). The callee, however, is not obliged to save them. This is somewhat similar to “Shadow Space”: [1.14.2 on page 101](#).

<sup>85</sup>Also available as <http://go.yurichev.com/17287>

Why did the optimizing GCC 4.9 drop this argument saving code? Because it did some additional optimizing work and concluded that the function arguments will not be needed in the future and also that the registers W0...W2 will not be used.

We also see a MUL/ADD instruction pair instead of single a MADD.

## 1.14.4 MIPS

Listing 1.99: Optimizing GCC 4.4.5

```
.text:00000000 f:
; $a0=a
; $a1=b
; $a2=c
.text:00000000      mult    $a1, $a0
.text:00000004      mflo    $v0
.text:00000008      jr      $ra
.text:0000000C      addu   $v0, $a2, $v0      ; branch delay slot
; result is in $v0 upon return
.text:00000010 main:
.text:00000010
.text:00000010 var_10 = -0x10
.text:00000010 var_4 = -4
.text:00000010
.text:00000010      lui    $gp, (__gnu_local_gp >> 16)
.text:00000014      addiu  $sp, -0x20
.text:00000018      la     $gp, (__gnu_local_gp & 0xFFFF)
.text:0000001C      sw    $ra, 0x20+var_4($sp)
.text:00000020      sw    $gp, 0x20+var_10($sp)
; set c:
.text:00000024      li     $a2, 3
; set a:
.text:00000028      li     $a0, 1
.text:0000002C      jal   f
; set b:
.text:00000030      li     $a1, 2      ; branch delay slot
; result in $v0 now
.text:00000034      lw    $gp, 0x20+var_10($sp)
.text:00000038      lui   $a0, ($LC0 >> 16)
.text:0000003C      lw    $t9, (printf & 0xFFFF)($gp)
.text:00000040      la   $a0, ($LC0 & 0xFFFF)
.text:00000044      jalr $t9
; take result of f() function and pass it as a second argument to printf():
.text:00000048      move  $a1, $v0      ; branch delay slot
.text:0000004C      lw    $ra, 0x20+var_4($sp)
.text:00000050      move  $v0, $zero
.text:00000054      jr    $ra
.text:00000058      addiu $sp, 0x20 ; branch delay slot
```

The first four function arguments are passed in four registers prefixed by A-.

There are two special registers in MIPS: HI and LO which are filled with the 64-bit result of the multiplication during the execution of the MULT instruction.

These registers are accessible only by using the MFLO and MFHI instructions. MFLO here takes the low-part of the multiplication result and stores it into \$V0. So the high 32-bit part of the multiplication result is dropped (the HI register content is not used). Indeed: we work with 32-bit *int* data types here.

Finally, ADDU (“Add Unsigned”) adds the value of the third argument to the result.

There are two different addition instructions in MIPS: ADD and ADDU. The difference between them is not related to signedness, but to exceptions. ADD can raise an exception on overflow, which is sometimes useful<sup>86</sup> and supported in Ada PL, for instance. ADDU does not raise exceptions on overflow.

Since C/C++ does not support this, in our example we see ADDU instead of ADD.

The 32-bit result is left in \$V0.

There is a new instruction for us in main(): JAL (“Jump and Link”).

<sup>86</sup><http://go.yurichev.com/17326>

The difference between JAL and JALR is that a relative offset is encoded in the first instruction, while JALR jumps to the absolute address stored in a register (“Jump and Link Register”).

Both `f()` and `main()` functions are located in the same object file, so the relative address of `f()` is known and fixed.

## 1.15 More about results returning

In x86, the result of function execution is usually returned <sup>87</sup> in the EAX register. If it is byte type or a character (*char*), then the lowest part of register EAX (AL) is used. If a function returns a *float* number, the FPU register ST(0) is used instead. In ARM, the result is usually returned in the R0 register.

### 1.15.1 Attempt to use the result of a function returning *void*

So, what if the `main()` function return value was declared of type *void* and not *int*? The so-called startup-code is calling `main()` roughly as follows:

```
push envp
push argv
push argc
call main
push eax
call exit
```

In other words:

```
exit(main(argv,argv,envp));
```

If you declare `main()` as *void*, nothing is to be returned explicitly (using the *return* statement), then something random, that has been stored in the EAX register at the end of `main()` becomes the sole argument of the `exit()` function. Most likely, there will be a random value, left from your function execution, so the exit code of program is pseudorandom.

We can illustrate this fact. Please note that here the `main()` function has a *void* return type:

```
#include <stdio.h>

void main()
{
    printf ("Hello, world!\n");
};
```

Let's compile it in Linux.

GCC 4.8.1 replaced `printf()` with `puts()` (we have seen this before: [1.5.3 on page 20](#)), but that's OK, since `puts()` returns the number of characters printed out, just like `printf()`. Please notice that EAX is not zeroed before `main()`'s end.

This implies that the value of EAX at the end of `main()` contains what `puts()` has left there.

Listing 1.100: GCC 4.8.1

```
.LC0:
    .string "Hello, world!"
main:
    push    ebp
    mov     ebp, esp
    and     esp, -16
    sub     esp, 16
    mov     DWORD PTR [esp], OFFSET FLAT:.LC0
```

<sup>87</sup>See also: MSDN: Return Values (C++): [MSDN](#)

```
call    puts
leave
ret
```

Let's write a bash script that shows the exit status:

Listing 1.101: tst.sh

```
#!/bin/sh
./hello_world
echo $?
```

And run it:

```
$ tst.sh
Hello, world!
14
```

14 is the number of characters printed. The number of characters printed *slips* from `printf()` through `EAX/RAX` into "exit code".

Another example in the book: [3.32 on page 644](#).

By the way, when we decompile C++ in Hex-Rays, we can often encounter a function which terminated with destructor of some class:

```
...
call    ??1CString@@QAE@XZ ; CString:: CString(void)
mov     ecx, [esp+30h+var_C]
pop     edi
pop     ebx
mov     large fs:0, ecx
add     esp, 28h
retn
```

By C++ standard, destructor doesn't return anything, but when Hex-Rays don't know about it, and thinks that both destructor and this function returns *int*, we can see something like that in output:

```
...
        return CString::~~CString(&Str);
}
```

### 1.15.2 What if we do not use the function result?

`printf()` returns the count of characters successfully output, but the result of this function is rarely used in practice.

It is also possible to call a function whose essence is in returning a value, and not use it:

```
int f()
{
    // skip first 3 random values:
    rand();
    rand();
    rand();
    // and use 4th:
    return rand();
};
```

The result of the `rand()` function is left in EAX, in all four cases.

But in the first 3 cases, the value in EAX is just not used.

### 1.15.3 Returning a structure

Let's go back to the fact that the return value is left in the EAX register.

That is why old C compilers cannot create functions capable of returning something that does not fit in one register (usually *int*), but if one needs it, one have to return information via pointers passed as function's arguments.

So, usually, if a function needs to return several values, it returns only one, and all the rest—via pointers.

Now it has become possible to return, let's say, an entire structure, but that is still not very popular. If a function has to return a large structure, the [caller](#) must allocate it and pass a pointer to it via the first argument, transparently for the programmer. That is almost the same as to pass a pointer in the first argument manually, but the compiler hides it.

Small example:

```
struct s
{
    int a;
    int b;
    int c;
};

struct s get_some_values (int a)
{
    struct s rt;

    rt.a=a+1;
    rt.b=a+2;
    rt.c=a+3;

    return rt;
};
```

...what we got (MSVC 2010 /Ox):

```
$T3853 = 8 ; size = 4
_a$ = 12 ; size = 4
?get_some_values@@YA?AU?AU?AU@@@H@Z PROC ; get_some_values
    mov     ecx, DWORD PTR _a$(esp-4)
    mov     eax, DWORD PTR $T3853[esp-4]
    lea     edx, DWORD PTR [ecx+1]
    mov     DWORD PTR [eax], edx
    lea     edx, DWORD PTR [ecx+2]
    add     ecx, 3
    mov     DWORD PTR [eax+4], edx
    mov     DWORD PTR [eax+8], ecx
    ret     0
?get_some_values@@YA?AU?AU?AU@@@H@Z ENDP ; get_some_values
```

The macro name for internal passing of pointer to a structure here is `$T3853`.

This example can be rewritten using the C99 language extensions:

```
struct s
{
    int a;
    int b;
    int c;
};

struct s get_some_values (int a)
{
    return (struct s){.a=a+1, .b=a+2, .c=a+3};
};
```

Listing 1.102: GCC 4.8.1

```

_get_some_values proc near
ptr_to_struct = dword ptr 4
a             = dword ptr 8

        mov     edx, [esp+a]
        mov     eax, [esp+ptr_to_struct]
        lea    ecx, [edx+1]
        mov     [eax], ecx
        lea    ecx, [edx+2]
        add    edx, 3
        mov     [eax+4], ecx
        mov     [eax+8], edx
        retn
_get_some_values endp

```

As we see, the function is just filling the structure's fields allocated by the caller function, as if a pointer to the structure has been passed. So there are no performance drawbacks.

## 1.16 Pointers

### 1.16.1 Returning values

Pointers are often used to return values from functions (recall `scanf()` case ( [1.12 on page 67](#))).

For example, when a function needs to return two values.

#### Global variables example

```

#include <stdio.h>

void f1 (int x, int y, int *sum, int *product)
{
    *sum=x+y;
    *product=x*y;
};

int sum, product;

void main()
{
    f1(123, 456, &sum, &product);
    printf ("sum=%d, product=%d\n", sum, product);
};

```

This compiles to:

Listing 1.103: Optimizing MSVC 2010 (/Ob0)

```

COMM    _product:DWORD
COMM    _sum:DWORD
$SG2803 DB      'sum=%d, product=%d', 0aH, 00H

_x$ = 8           ; size = 4
_y$ = 12          ; size = 4
_sum$ = 16        ; size = 4
_product$ = 20    ; size = 4
_f1     PROC
        mov     ecx, DWORD PTR _y$[esp-4]
        mov     eax, DWORD PTR _x$[esp-4]
        lea    edx, DWORD PTR [eax+ecx]
        imul   eax, ecx
        mov     ecx, DWORD PTR _product$[esp-4]
        push   esi
        mov     esi, DWORD PTR _sum$[esp]
        mov     DWORD PTR [esi], edx
        mov     DWORD PTR [ecx], eax

```



```

    pop     esi
    ret     0
_f1   ENDP

_main PROC
    push   OFFSET _product
    push   OFFSET _sum
    push   456      ; 000001c8H
    push   123     ; 0000007bH
    call   _f1
    mov    eax, DWORD PTR _product
    mov    ecx, DWORD PTR _sum
    push   eax
    push   ecx
    push   OFFSET $SG2803
    call   DWORD PTR __imp__printf
    add    esp, 28
    xor    eax, eax
    ret     0
_main ENDP

```

Let's see this in OllyDbg:

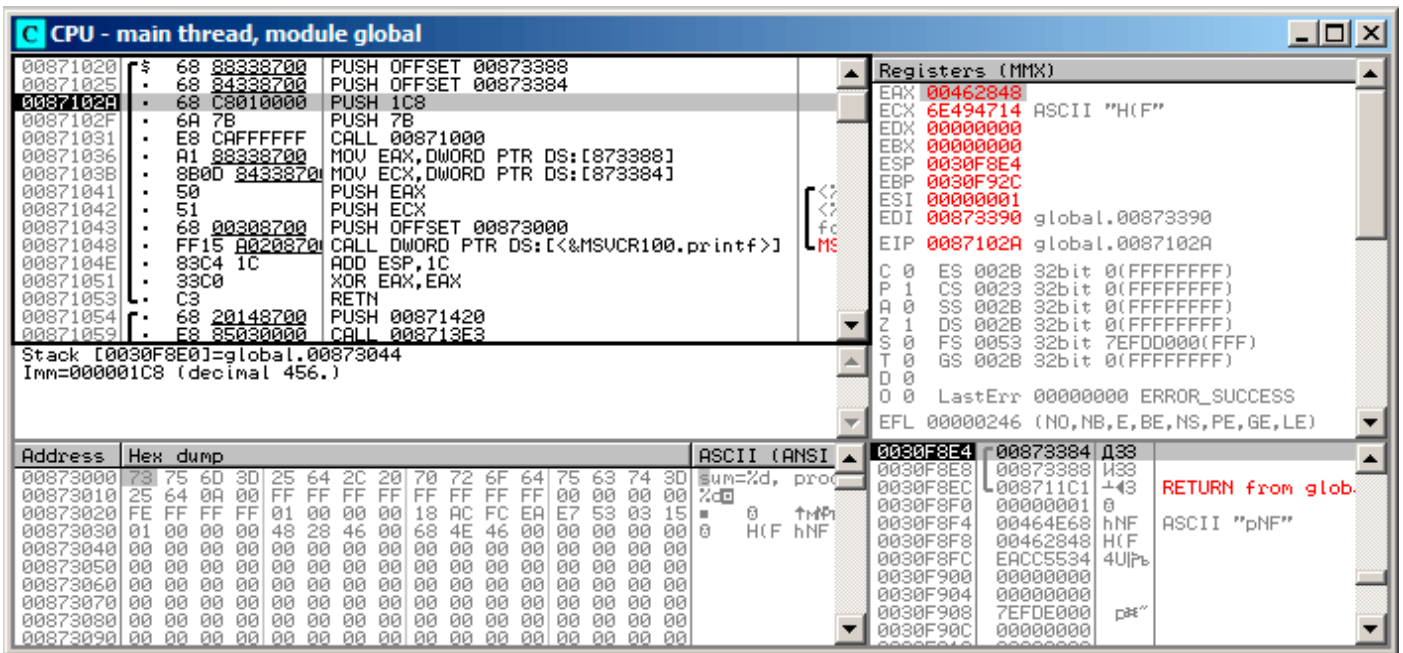

Figure 1.25: OllyDbg: global variables addresses are passed to f1()

First, global variables' addresses are passed to f1(). We can click "Follow in dump" on the stack element, and we can see the place in the data segment allocated for the two variables.

These variables are zeroed, because non-initialized data (from BSS) is cleared before the execution begins, [see ISO/IEC 9899:TC3 (C C99 standard), (2007) 6.7.8p10].

They reside in the data segment, we can verify this by pressing Alt-M and reviewing the memory map:

Address	Size	Owner	Section	Contains	Type	Access	Initial	Mapped as
00050000	00004000				Map	R	R	
00060000	00001000				Priv	RW	RW	
00070000	00007000				Map	R	R	C:\Windows\System32\Loc
00159000	00007000				Priv	RW	RW	Gua: Gua:
00300000	00001000				Priv	RW	RW	Gua: Gua:
0030E000	00002000			Stack of main thread	Priv	RW	RW	
00460000	00005000			Heap	Priv	RW	RW	
004A0000	00007000				Priv	RW	RW	
006B0000	0000C000			Default heap	Priv	RW	RW	
00870000	00001000	global		PE header	Img	R	RWE	Cop:
00871000	00001000	global	.text	Code	Img	R E	RWE	Cop:
00872000	00001000	global	.rdata	Imports	Img	R	RWE	Cop:
00873000	00001000	global	.data	Data	Img	RW	RWE	Cop:
00874000	00001000	global	.reloc	Relocations	Img	R	RWE	Cop:
6E3E0000	00001000	MSVCR100		PE header	Img	R	RWE	Cop:
6E3E1000	00002000	MSVCR100	.text	Code, imports, exports	Img	R E	RWE	Cop:
6E493000	00006000	MSVCR100	.data	Data	Img	RW	RWE	Cop:
6E499000	00001000	MSVCR100	.rsrc	Resources	Img	R	RWE	Cop:
6E49A000	00005000	MSVCR100	.reloc	Relocations	Img	R	RWE	Cop:
75500000	00001000	Mod_755D		PE header	Img	R	RWE	Cop:
755D1000	00003000				Img	R E	RWE	Cop:
755D4000	00001000				Img	RW	RWE	Cop:
755D5000	00003000				Img	R	RWE	Cop:
755E0000	00001000	Mod_755E		PE header	Img	R	RWE	Cop:
755E1000	00004000				Img	R E	RWE	Cop:
7562E000	00005000				Img	RW	RWE	Cop:
75633000	00009000				Img	R	RWE	Cop:

Figure 1.26: OllyDbg: memory map

Let's trace (F7) to the start of f1():

The screenshot shows the OllyDbg interface with the following details:

- Disassembly:**

```

00871000 8B4C24 08 MOV ECX,DWORD PTR SS:[ARG.2]
00871004 8B4424 04 MOV EAX,DWORD PTR SS:[ARG.1]
00871008 8D1408 LEA EDX,[ECX+EAX]
0087100B 0FAFC1 IMUL EAX,ECX
0087100E 8B4C24 10 MOV ECX,DWORD PTR SS:[ARG.4]
00871012 56 PUSH ESI
00871013 8B7424 10 MOV ESI,DWORD PTR SS:[ARG.3]
00871017 8916 MOV DWORD PTR DS:[ESI],EDX
00871019 8901 MOV DWORD PTR DS:[ECX],EAX
0087101B 5E POP ESI
0087101C C3 RETN
0087101D CC INT3
0087101E CC INT3
0087101F CC INT3
00871020 68 88338700 PUSH OFFSET 00873388
00871025 68 84338700 PUSH OFFSET 00873384

```
- Registers (MMX):**
  - EAX: 00462848
  - ECX: 6E494714 ASCII "H(F"
  - EDX: 00000000
  - EBX: 00000000
  - ESP: 0030F8D8
  - EBP: 0030F92C
  - ESI: 00000001
  - EDI: 00873390 global.00873390
  - EIP: 00871000 global.00871000
- Stack:**
  - [0030F8E0]=000001C8 (decimal 456.)
  - ECX=6E494714 (MSUCR100.\_\_initenv)
  - Local call from 871031
- Hex dump:**

Address	Hex dump	ASCII (ANSI)
00873000	73 75 6D 3D 25 64 2C 20 70 72 6F 64 75 63 74 3D	sum=%d, proc
00873010	25 64 0A 00 FF FF FF FF FF FF FF FF 00 00 00 00	%d
00873020	FE FF FF FF 01 00 00 00 18 AC FC EA E7 53 03 15	0 H(F hNF
00873030	01 00 00 00 48 28 46 00 68 4E 46 00 00 00 00 00	
00873040	00 00 00 00 00 00 00 00 00 00 00 00 00 00 00 00	
00873050	00 00 00 00 00 00 00 00 00 00 00 00 00 00 00 00	
00873060	00 00 00 00 00 00 00 00 00 00 00 00 00 00 00 00	
00873070	00 00 00 00 00 00 00 00 00 00 00 00 00 00 00 00	
00873080	00 00 00 00 00 00 00 00 00 00 00 00 00 00 00 00	
00873090	00 00 00 00 00 00 00 00 00 00 00 00 00 00 00 00	
- Return Address:** 0030F8D8 (00871036) RETURN from glob.

Figure 1.27: OllyDbg: f1() starts

Two values are visible in the stack: 456 (0x1C8) and 123 (0x7B), and also the addresses of the two global variables.

Let's trace until the end of f1(). In the left bottom window we see how the results of the calculation appear in the global variables:

The screenshot shows the OllyDbg interface with the following components:

- Assembly Window:** Shows assembly instructions for the `f1()` function. The instruction at address `0087101B` is `POP ESI`, which is highlighted. Below it, the stack pointer `EIP` is at `0087101B`. The stack is empty, with `Top of stack [0030F8D4]=1` and `ESI=global.00873384`.
- Registers (MMX) Window:** Shows the state of registers. `EAX` is `00000B18`, `ECX` is `00873388` (pointing to `global.00873388`), `EDX` is `00000243`, `EBX` is `00000000`, `ESP` is `0030F8D4`, `EBP` is `0030F92C`, `ESI` is `00873384` (pointing to `global.00873384`), and `EDI` is `00873390` (pointing to `global.00873390`).
- Memory Dump Window:** Shows a hex dump of memory starting at `00873384`. The first four bytes are `43 02 00 00`, which are highlighted with a red box. The ASCII column shows `m/E5m/E5`.
- Registers (MMX) Window (continued):** Shows the state of registers. `EAX` is `00000001`, `EAX` is `00871036`, `EAX` is `0000007B`, `EAX` is `000001C8`, `EAX` is `00873384`, `EAX` is `00873388`, `EAX` is `008711C1`, `EAX` is `00000001`, `EAX` is `00464E68`, `EAX` is `00462848`, and `EAX` is `EACC5534`. The ASCII column shows `RETURN from glob.`, `RETURN from glob.`, and `ASCII "pNF"`.

Figure 1.28: OllyDbg: f1() execution completed

Now the global variables' values are loaded into registers ready for passing to printf() (via the stack):

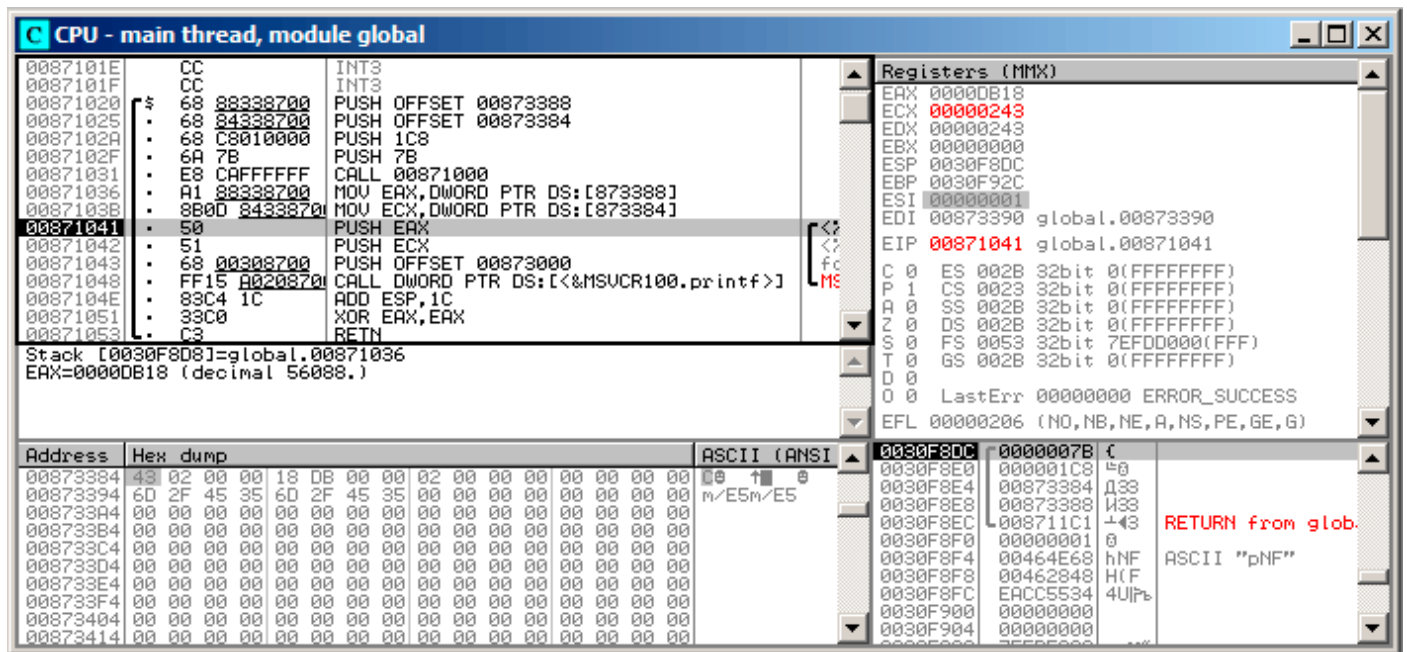

Figure 1.29: OllyDbg: global variables' values are passed into printf()

### Local variables example

Let's rework our example slightly:

Listing 1.104: now the sum and product variables are local

```
void main()
{
    int sum, product; // now variables are local in this function

    f1(123, 456, &sum, &product);
    printf ("sum=%d, product=%d\n", sum, product);
};
```

f1() code will not change. Only the code of main() will do:

Listing 1.105: Optimizing MSVC 2010 (/Ob0)

```
_product$ = -8          ; size = 4
_sum$ = -4             ; size = 4
_main PROC
; Line 10
sub     esp, 8
; Line 13
lea    eax, DWORD PTR _product$[esp+8]
push   eax
lea    ecx, DWORD PTR _sum$[esp+12]
push   ecx
push   456          ; 000001c8H
push   123         ; 0000007bH
call   _f1
; Line 14
mov    edx, DWORD PTR _product$[esp+24]
mov    eax, DWORD PTR _sum$[esp+24]
push   edx
push   eax
push   OFFSET $SG2803
call   DWORD PTR __imp__printf
; Line 15
xor    eax, eax
add    esp, 36
ret    0
```

Let's look again with OllyDbg. The addresses of the local variables in the stack are 0x2EF854 and 0x2EF858. We see how these are pushed into the stack:

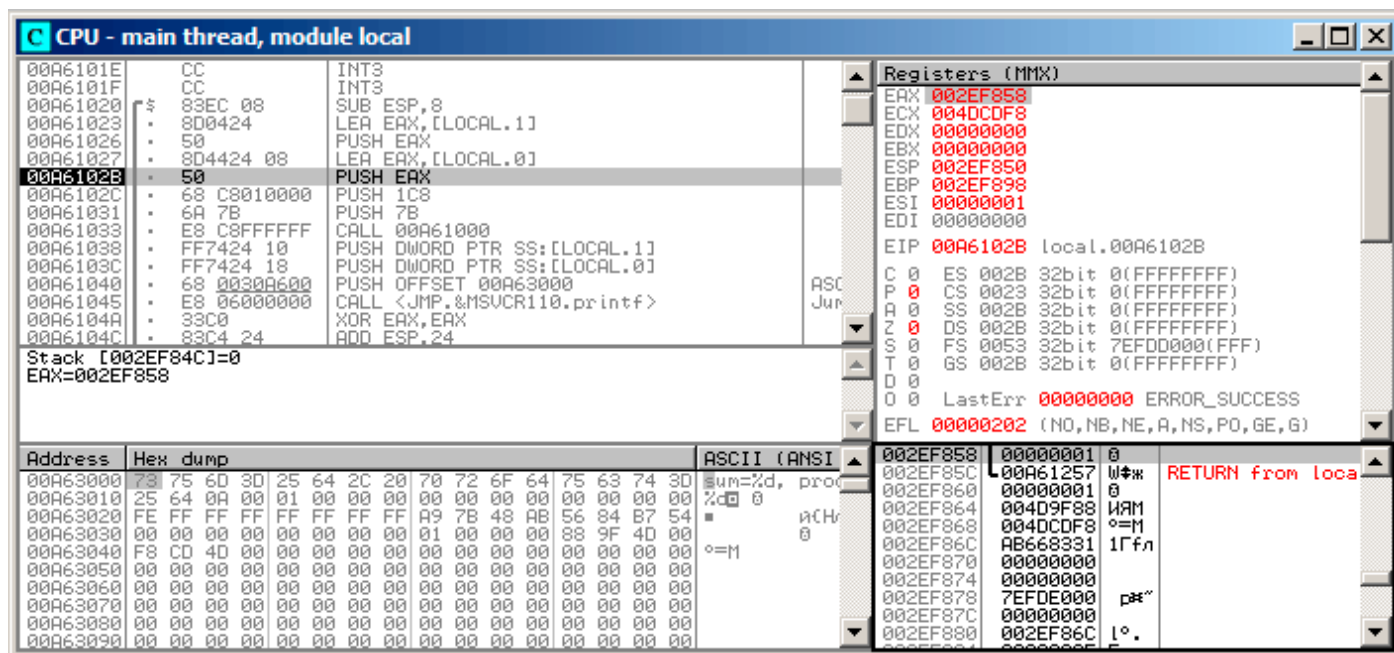

Figure 1.30: OllyDbg: local variables' addresses are pushed into the stack

f1() starts. So far there is only random garbage in the stack at 0x2EF854 and 0x2EF858:

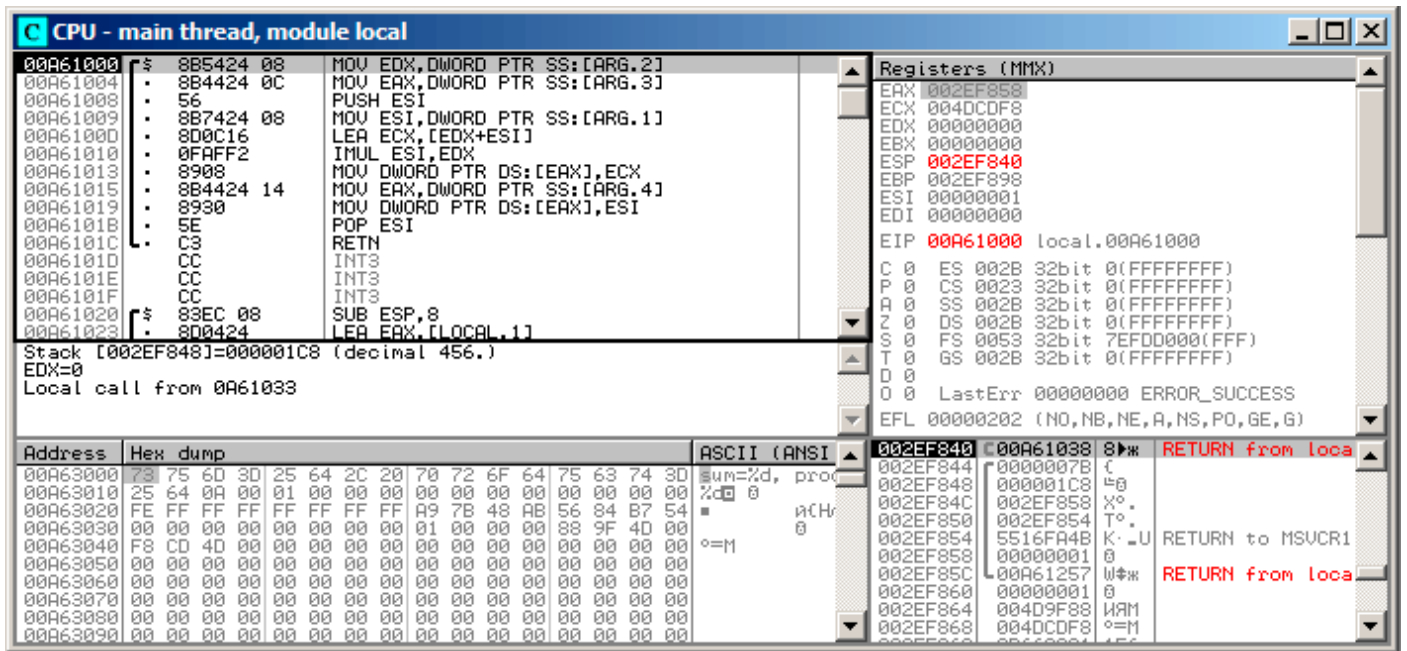

Figure 1.31: OllyDbg: f1() starting



f1() completes:

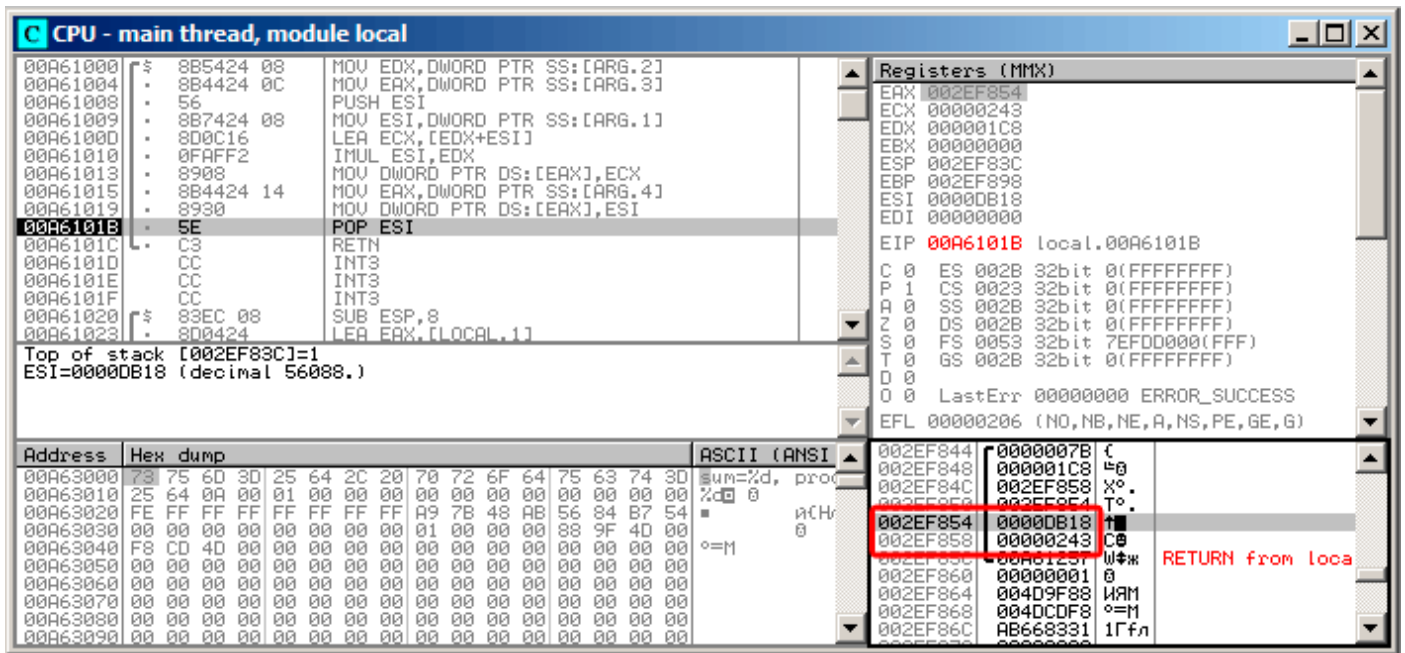

Figure 1.32: OllyDbg: f1() completes execution

We now find 0xDB18 and 0x243 at addresses 0x2EF854 and 0x2EF858. These values are the f1() results.

### Conclusion

f1() could return pointers to any place in memory, located anywhere.

This is in essence the usefulness of the pointers.

By the way, C++ *references* work exactly the same way. Read more about them: ([3.21.3 on page 563](#)).

### 1.16.2 Swap input values

This will do the job:

```
#include <memory.h>
#include <stdio.h>

void swap_bytes (unsigned char* first, unsigned char* second)
{
    unsigned char tmp1;
    unsigned char tmp2;

    tmp1=*first;
    tmp2=*second;

    *first=tmp2;
    *second=tmp1;
};

int main()
{
    // copy string into heap, so we will be able to modify it
    char *s=strdup("string");

    // swap 2nd and 3rd characters
    swap_bytes (s+1, s+2);

    printf ("%s\n", s);
};
```

As we can see, bytes are loaded into lower 8-bit parts of ECX and EBX using MOVZX (so higher parts of these registers will be cleared) and then bytes are written back swapped.

Listing 1.106: Optimizing GCC 5.4

```
swap_bytes:
    push    ebx
    mov     edx, DWORD PTR [esp+8]
    mov     eax, DWORD PTR [esp+12]
    movzx  ecx, BYTE PTR [edx]
    movzx  ebx, BYTE PTR [eax]
    mov     BYTE PTR [edx], bl
    mov     BYTE PTR [eax], cl
    pop     ebx
    ret
```

Addresses of both bytes are taken from arguments and through execution of the function are located in EDX and EAX.

So we use pointers: probably, there is no better way to solve this task without them.

## 1.17 GOTO operator

The GOTO operator is generally considered as anti-pattern, see [Edgar Dijkstra, *Go To Statement Considered Harmful* (1968)<sup>88</sup>]. Nevertheless, it can be used reasonably, see [Donald E. Knuth, *Structured Programming with go to Statements* (1974)<sup>89</sup> <sup>90</sup>.

Here is a very simple example:

```
#include <stdio.h>

int main()
{
    printf ("begin\n");
    goto exit;
    printf ("skip me!\n");
exit:
    printf ("end\n");
};
```

Here is what we have got in MSVC 2012:

Listing 1.107: MSVC 2012

```
$SG2934 DB    'begin', 0aH, 00H
$SG2936 DB    'skip me!', 0aH, 00H
$SG2937 DB    'end', 0aH, 00H

_main    PROC
    push    ebp
    mov     ebp, esp
    push    OFFSET $SG2934 ; 'begin'
    call    _printf
    add     esp, 4
    jmp     SHORT $exit$3
    push    OFFSET $SG2936 ; 'skip me!'
    call    _printf
    add     esp, 4
$exit$3:
    push    OFFSET $SG2937 ; 'end'
    call    _printf
    add     esp, 4
    xor     eax, eax
    pop     ebp
    ret     0
_main    ENDP
```

<sup>88</sup><http://yurichev.com/mirrors/Dijkstra68.pdf>

<sup>89</sup><http://yurichev.com/mirrors/KnuthStructuredProgrammingGoTo.pdf>

<sup>90</sup>[Dennis Yurichev, *C/C++ programming language notes*] also has some examples.

The *goto* statement has been simply replaced by a JMP instruction, which has the same effect: unconditional jump to another place. The second `printf()` could be executed only with human intervention, by using a debugger or by patching the code.

This could also be useful as a simple patching exercise. Let's open the resulting executable in Hiew:

```
Hiew: goto.exe
C:\Polygon\goto.exe  FRO ----- a32 PE .00401000
.00401000: 55      push   ebp
.00401001: 8BEC   mov    ebp,esp
.00401003: 6800304000 push  000403000 ;'begin' --[1]
.00401008: FF1590204000 call  printf
.0040100E: 83C404 add    esp,4
.00401011: EB0E   jmps  .00401021 --[2]
.00401013: 6808304000 push  000403008 ;'skip me!' --[3]
.00401018: FF1590204000 call  printf
.0040101E: 83C404 add    esp,4
.00401021: 6814304000 2push  000403014 --[4]
.00401026: FF1590204000 call  printf
.0040102C: 83C404 add    esp,4
.0040102F: 33C0   xor    eax,eax
.00401031: 5D     pop    ebp
.00401032: C3     retn  ; _^_^_^_^_^_^_^_^_^_^_^_^_^_^_^_
```

Figure 1.33: Hiew

Place the cursor to address JMP (0x410), press F3 (edit), press zero twice, so the opcode becomes EB 00:

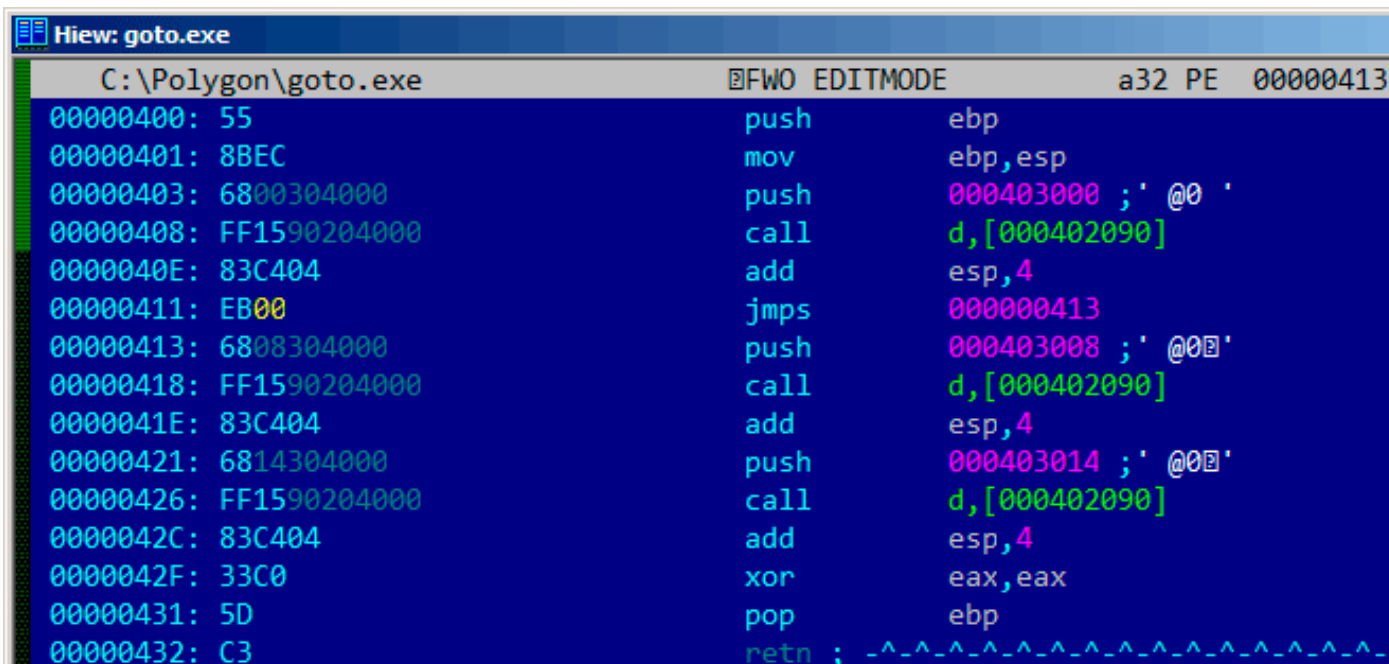

Figure 1.34: Hiew

The second byte of the JMP opcode denotes the relative offset for the jump, 0 means the point right after the current instruction.

So now JMP not skipping the second printf() call.

Press F9 (save) and exit. Now if we run the executable we will see this:

Listing 1.108: Patched executable output

```
C:\...\>goto.exe
begin
skip me!
end
```

The same result could be achieved by replacing the JMP instruction with 2 NOP instructions.

NOP has an opcode of 0x90 and length of 1 byte, so we need 2 instructions as JMP replacement (which is 2 bytes in size).

### 1.17.1 Dead code

The second printf() call is also called “dead code” in compiler terms.

This means that the code will never be executed. So when you compile this example with optimizations, the compiler removes “dead code”, leaving no trace of it:

Listing 1.109: Optimizing MSVC 2012

```
$SG2981 DB 'begin', 0aH, 00H
$SG2983 DB 'skip me!', 0aH, 00H
$SG2984 DB 'end', 0aH, 00H

_main PROC
push OFFSET $SG2981 ; 'begin'
call _printf
push OFFSET $SG2984 ; 'end'
$exit$4:
call _printf
add esp, 8
xor eax, eax
ret 0
```

However, the compiler forgot to remove the “skip me!” string.

## 1.17.2 Exercise

Try to achieve the same result using your favorite compiler and debugger.

## 1.18 Conditional jumps

### 1.18.1 Simple example

```
#include <stdio.h>

void f_signed (int a, int b)
{
    if (a>b)
        printf ("a>b\n");
    if (a==b)
        printf ("a==b\n");
    if (a<b)
        printf ("a<b\n");
};

void f_unsigned (unsigned int a, unsigned int b)
{
    if (a>b)
        printf ("a>b\n");
    if (a==b)
        printf ("a==b\n");
    if (a<b)
        printf ("a<b\n");
};

int main()
{
    f_signed(1, 2);
    f_unsigned(1, 2);
    return 0;
};
```

## x86

### x86 + MSVC

Here is how the `f_signed()` function looks like:

Listing 1.110: Non-optimizing MSVC 2010

```
_a$ = 8
_b$ = 12
_f_signed PROC
    push    ebp
    mov     ebp, esp
    mov     eax, DWORD PTR _a$[ebp]
    cmp     eax, DWORD PTR _b$[ebp]
    jle     SHORT $LN3@f_signed
    push    OFFSET $SG737          ; 'a>b'
    call   _printf
    add     esp, 4
$LN3@f_signed:
    mov     ecx, DWORD PTR _a$[ebp]
    cmp     ecx, DWORD PTR _b$[ebp]
    jne     SHORT $LN2@f_signed
    push    OFFSET $SG739          ; 'a==b'
    call   _printf
```

```

    add    esp, 4
$LN2@f_signed:
    mov    edx, DWORD PTR _a$[ebp]
    cmp    edx, DWORD PTR _b$[ebp]
    jge    SHORT $LN4@f_signed
    push   OFFSET $SG741      ; 'a<b'
    call   _printf
    add    esp, 4
$LN4@f_signed:
    pop    ebp
    ret    0
_f_signed ENDP

```

The first instruction, JLE, stands for *Jump if Less or Equal*. In other words, if the second operand is larger or equal to the first one, the control flow will be passed to the address or label specified in the instruction. If this condition does not trigger because the second operand is smaller than the first one, the control flow would not be altered and the first printf() would be executed. The second check is JNE: *Jump if Not Equal*. The control flow will not change if the operands are equal.

The third check is JGE: *Jump if Greater or Equal*—jump if the first operand is larger than the second or if they are equal. So, if all three conditional jumps are triggered, none of the printf() calls would be executed whatsoever. This is impossible without special intervention. Now let's take a look at the f\_unsigned() function. The f\_unsigned() function is the same as f\_signed(), with the exception that the JBE and JAE instructions are used instead of JLE and JGE, as follows:

Listing 1.111: GCC

```

_a$ = 8   ; size = 4
_b$ = 12  ; size = 4
_f_unsigned PROC
    push   ebp
    mov    ebp, esp
    mov    eax, DWORD PTR _a$[ebp]
    cmp    eax, DWORD PTR _b$[ebp]
    jbe    SHORT $LN3@f_unsigned
    push   OFFSET $SG2761      ; 'a>b'
    call   _printf
    add    esp, 4
$LN3@f_unsigned:
    mov    ecx, DWORD PTR _a$[ebp]
    cmp    ecx, DWORD PTR _b$[ebp]
    jne    SHORT $LN2@f_unsigned
    push   OFFSET $SG2763      ; 'a==b'
    call   _printf
    add    esp, 4
$LN2@f_unsigned:
    mov    edx, DWORD PTR _a$[ebp]
    cmp    edx, DWORD PTR _b$[ebp]
    jae    SHORT $LN4@f_unsigned
    push   OFFSET $SG2765      ; 'a<b'
    call   _printf
    add    esp, 4
$LN4@f_unsigned:
    pop    ebp
    ret    0
_f_unsigned ENDP

```

As already mentioned, the branch instructions are different: JBE—*Jump if Below or Equal* and JAE—*Jump if Above or Equal*. These instructions (JA/JAE/JB/JBE) differ from JG/JGE/JL/JLE in the fact that they work with unsigned numbers.

See also the section about signed number representations ( [2.2 on page 452](#)). That is why if we see JG/JL in use instead of JA/JB or vice-versa, we can be almost sure that the variables are signed or unsigned, respectively. Here is also the main() function, where there is nothing much new to us:

Listing 1.112: main()

```

_main PROC
    push   ebp
    mov    ebp, esp

```

```
    push    2
    push    1
    call    _f_signed
    add     esp, 8
    push    2
    push    1
    call    _f_unsigned
    add     esp, 8
    xor     eax, eax
    pop     ebp
    ret     0
_main    ENDP
```



## x86 + MSVC + OllyDbg

We can see how flags are set by running this example in OllyDbg. Let's begin with `f_unsigned()`, which works with unsigned numbers.

CMP is executed thrice here, but for the same arguments, so the flags are the same each time.

Result of the first comparison:

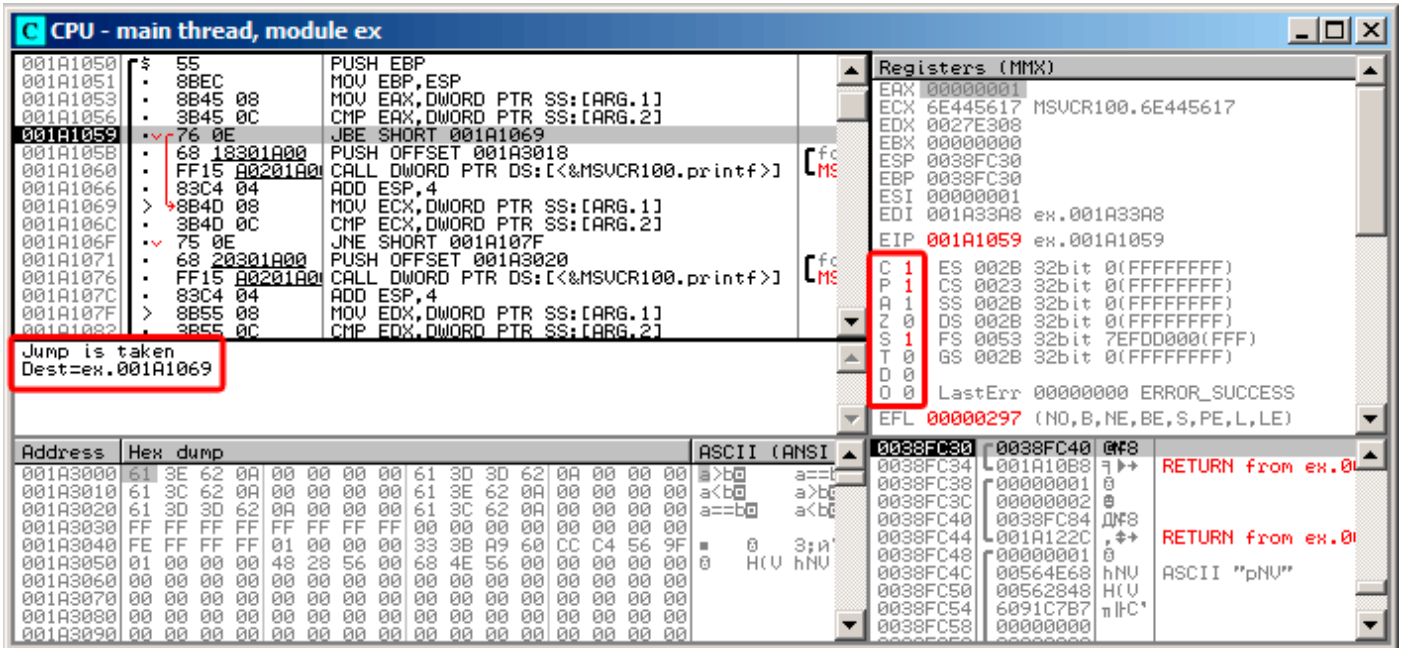

Figure 1.35: OllyDbg: `f_unsigned()`: first conditional jump

So, the flags are: C=1, P=1, A=1, Z=0, S=1, T=0, D=0, O=0.

They are named with one character for brevity in OllyDbg.

OllyDbg gives a hint that the (JBE) jump is to be triggered now. Indeed, if we take a look into Intel manuals ([12.1.4 on page 1014](#)), we can read there that JBE is triggering if CF=1 or ZF=1. The condition is true here, so the jump is triggered.

The next conditional jump:

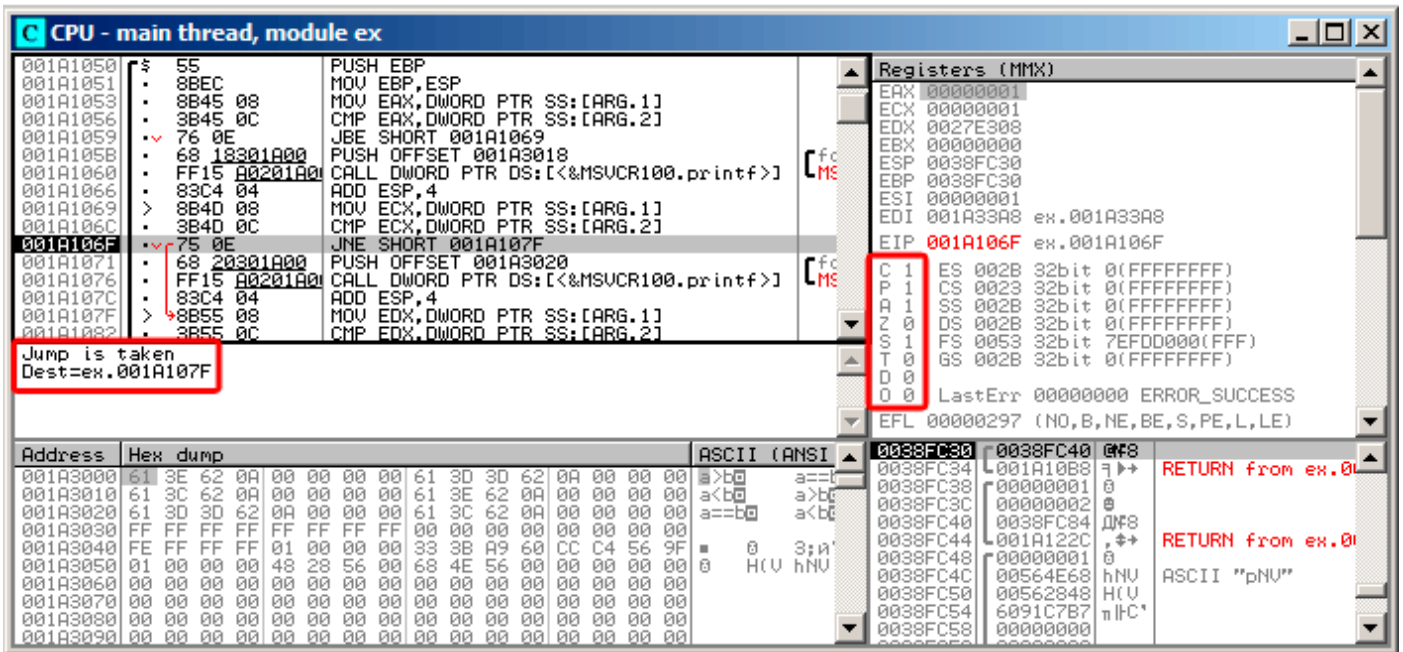

Figure 1.36: OllyDbg: f\_unsigned(): second conditional jump

OllyDbg gives a hint that JNZ is to be triggered now. Indeed, JNZ triggering if ZF=0 (zero flag).

The third conditional jump, JNB:

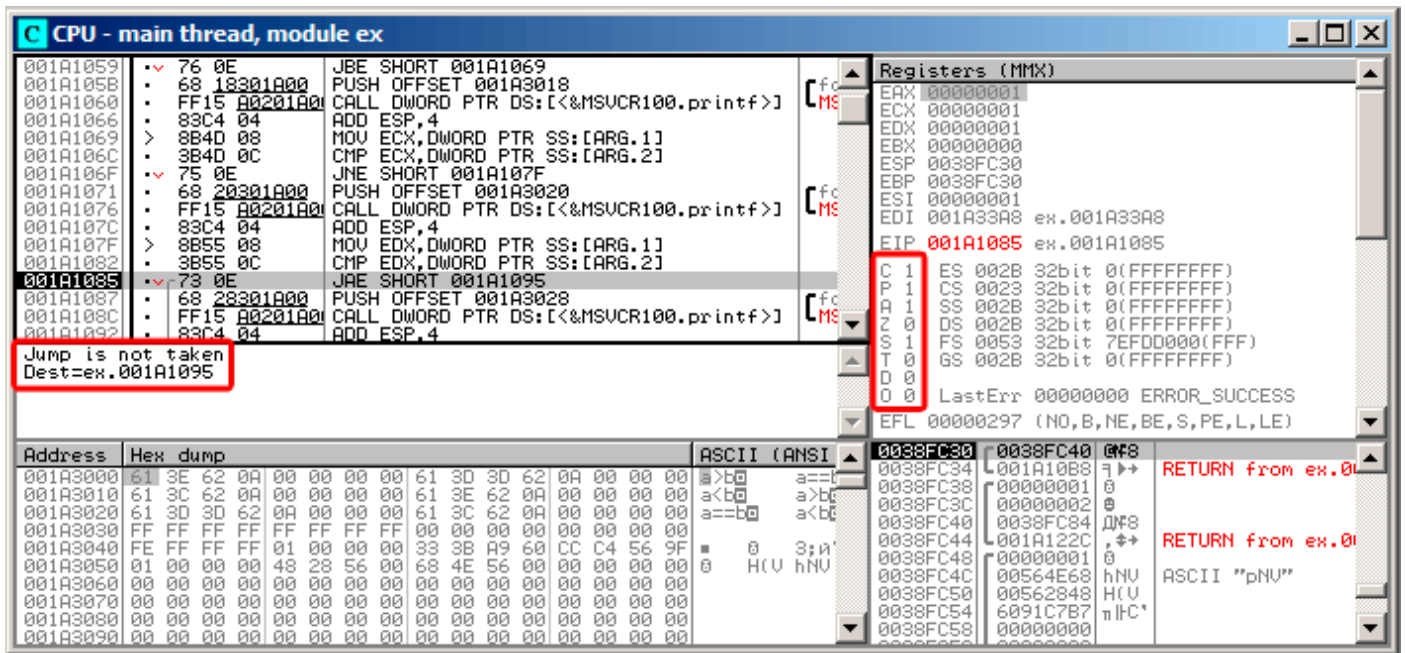

Figure 1.37: OllyDbg: f\_unsigned(): third conditional jump

In Intel manuals ( [12.1.4 on page 1014](#)) we can see that JNB triggers if CF=0 (carry flag). That is not true in our case, so the third printf() will execute.

Now let's review the `f_signed()` function, which works with signed values, in OllyDbg. Flags are set in the same way: C=1, P=1, A=1, Z=0, S=1, T=0, D=0, O=0. The first conditional jump JLE is to be triggered:

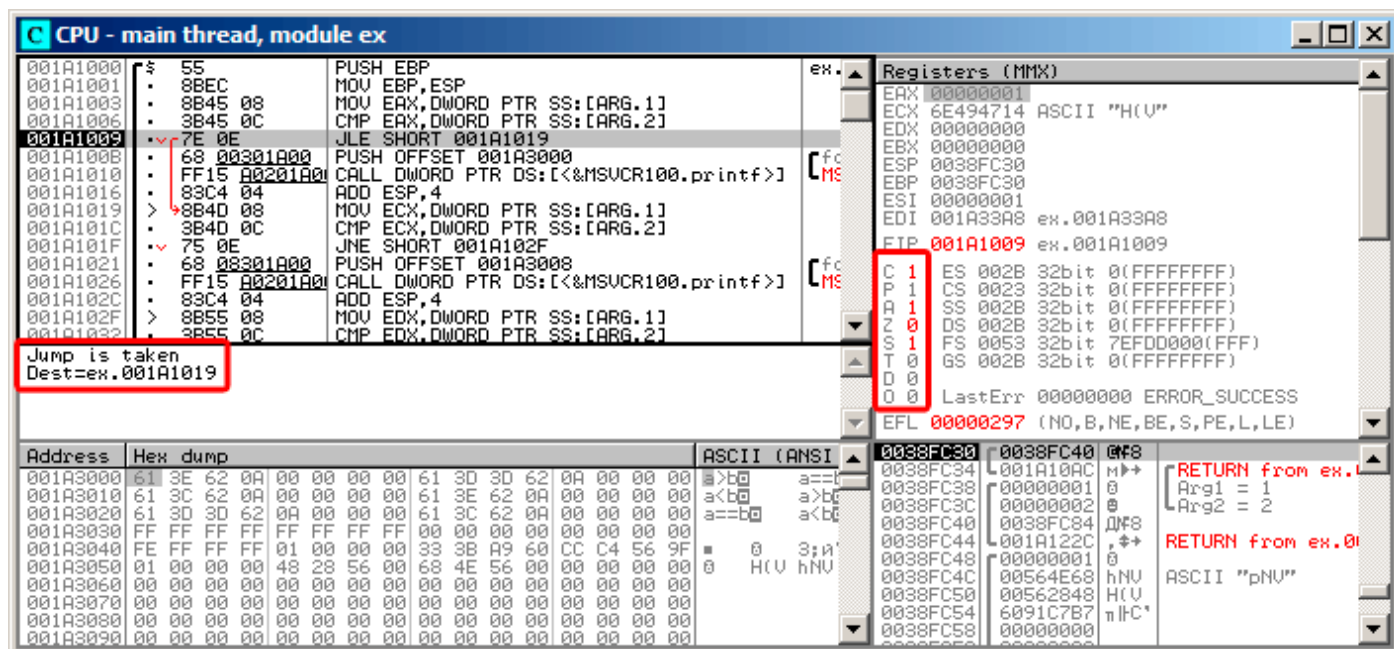

Figure 1.38: OllyDbg: `f_signed()`: first conditional jump

In Intel manuals ( [12.1.4 on page 1014](#)) we find that this instruction is triggered if  $ZF=1$  or  $SF \neq OF$ .  $SF \neq OF$  in our case, so the jump triggers.

The second JNZ conditional jump triggering: if ZF=0 (zero flag):

The screenshot shows the OllyDbg interface for the CPU - main thread, module ex. The assembly window displays the following code:

```

001A1000 55          PUSH EBP
001A1001 8BEC       MOV EBP,ESP
001A1003 8B45 08    MOV EAX,DWORD PTR SS:[ARG.1]
001A1006 3B45 0C    CMP EAX,DWORD PTR SS:[ARG.2]
001A1009 7E 0E     JLE SHORT 001A1019
001A100B 68 00301A00 PUSH OFFSET 001A3000
001A100E FF15 00201A00 CALL DWORD PTR DS:[<&MSUCR100.printf>]
001A1010 83C4 04    ADD ESP,4
001A1013 8B4D 08    MOV ECX,DWORD PTR SS:[ARG.1]
001A1016 3B4D 0C    CMP ECX,DWORD PTR SS:[ARG.2]
001A101F 75 0E     JNE SHORT 001A102F
001A1021 68 00301A00 PUSH OFFSET 001A3000
001A1024 FF15 00201A00 CALL DWORD PTR DS:[<&MSUCR100.printf>]
001A1027 83C4 04    ADD ESP,4
001A102A 8B55 08    MOV EDX,DWORD PTR SS:[ARG.1]
001A102D 3B55 0C    CMP EDX,DWORD PTR SS:[ARG.2]
  
```

The instruction at address 001A101F is highlighted, and a red box around it contains the message: "Jump is taken Dest=ex.001A102F".

The Registers (MMX) window shows the following values:

```

EAX 00000001
ECX 00000001
EDX 00000000
EBX 00000000
ESP 0038FC30
EBP 0038FC30
ESI 00000001
EDI 001A33A8 ex.001A33A8
EIP 001A101F ex.001A101F
  
```

The status bar shows the Zero Flag (Z) is 0, indicating the JNZ instruction is taken.

The memory dump window shows the following data:

```

Address Hex dump ASCII (ANSI)
001A3000 61 3E 62 0A 00 00 00 00 61 3D 3D 62 0A 00 00 00  a>b0 a==b0
001A3010 61 3C 62 0A 00 00 00 00 61 3E 62 0A 00 00 00 00  a<b0 a>b0
001A3020 61 3D 3D 62 0A 00 00 00 61 3C 62 0A 00 00 00 00  a==b0 a<b0
001A3030 FF FF FF FF FF FF FF FF 00 00 00 00 00 00 00 00
001A3040 FE FF FF FF 01 00 00 00 33 3B A9 60 CC C4 56 9F
001A3050 01 00 00 00 48 28 56 00 68 4E 56 00 00 00 00 00  H(U hNU
001A3060 00 00 00 00 00 00 00 00 00 00 00 00 00 00 00 00
001A3070 00 00 00 00 00 00 00 00 00 00 00 00 00 00 00 00
001A3080 00 00 00 00 00 00 00 00 00 00 00 00 00 00 00 00
001A3090 00 00 00 00 00 00 00 00 00 00 00 00 00 00 00 00
  
```

The return window shows the following return information:

```

RETURN from ex.0
Arg1 = 1
Arg2 = 2
RETURN from ex.0
ASCII "pNU"
  
```

Figure 1.39: OllyDbg: f\_signed(): second conditional jump

The third conditional jump JGE will not trigger because it would only do so if SF=OF, and that is not true in our case:

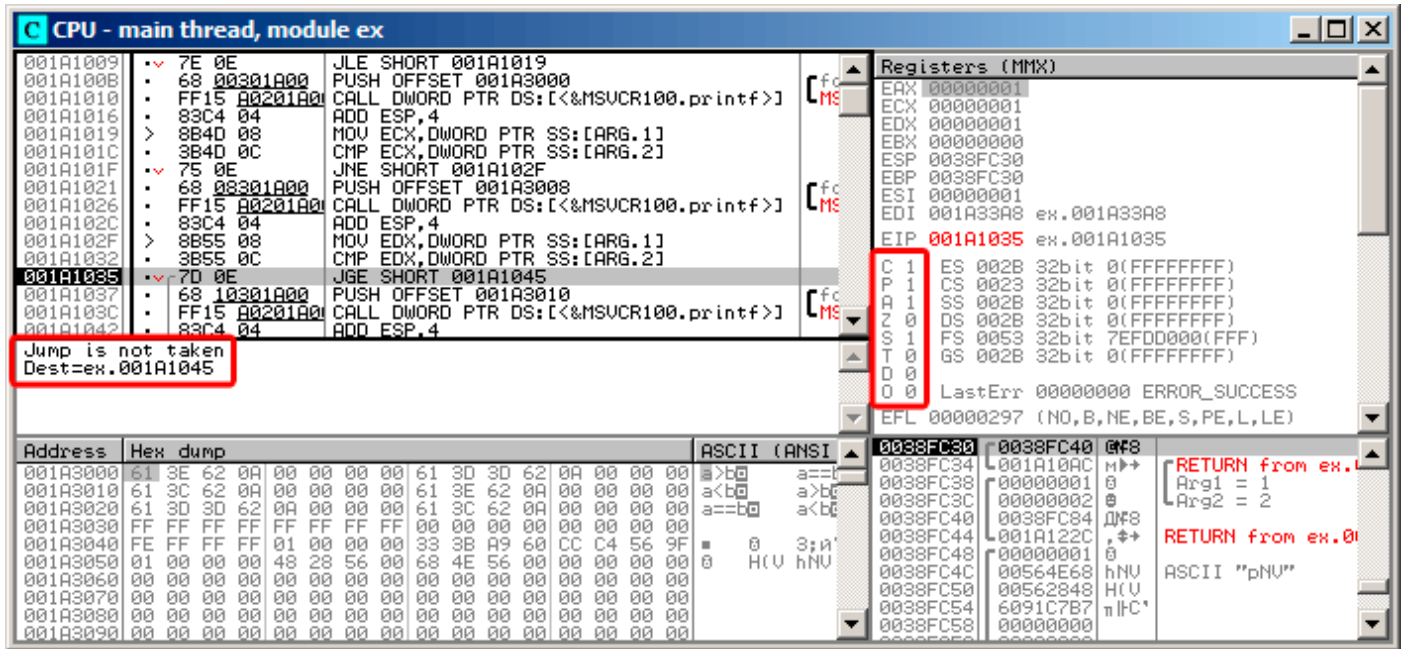
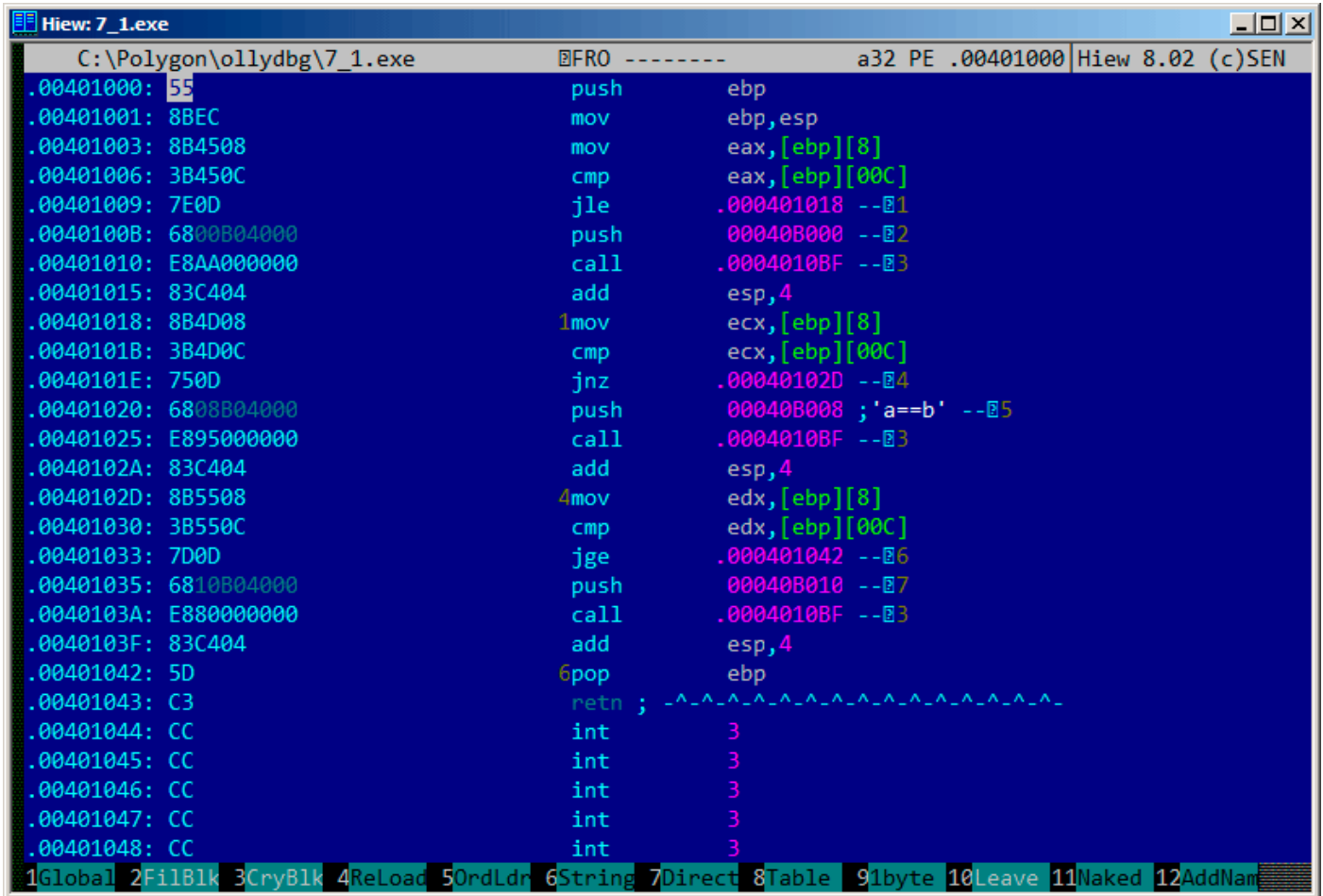

Figure 1.40: OllyDbg: f\_signed(): third conditional jump

## x86 + MSVC + Hiew

We can try to patch the executable file in a way that the `f_unsigned()` function would always print “a==b”, no matter the input values. Here is how it looks in Hiew:



```
C:\Polygon\ollydbg\7_1.exe  FRO ----- a32 PE .00401000 Hiew 8.02 (c)SEN
.00401000: 55          push     ebp
.00401001: 8BEC       mov     ebp,esp
.00401003: 8B4508     mov     eax,[ebp+8]
.00401006: 3B450C     cmp     eax,[ebp+00C]
.00401009: 7E0D      jle     .000401018 --E1
.0040100B: 6800B04000 push    00040B000 --E2
.00401010: E8AA000000 call    .0004010BF --E3
.00401015: 83C404     add     esp,4
.00401018: 8B4D08     1mov    ecx,[ebp+8]
.0040101B: 3B4D0C     cmp     ecx,[ebp+00C]
.0040101E: 750D      jnz     .00040102D --E4
.00401020: 6808B04000 push    00040B008 ; 'a==b' --E5
.00401025: E895000000 call    .0004010BF --E3
.0040102A: 83C404     add     esp,4
.0040102D: 8B5508     4mov    edx,[ebp+8]
.00401030: 3B550C     cmp     edx,[ebp+00C]
.00401033: 7D0D      jge     .000401042 --E6
.00401035: 6810B04000 push    00040B010 --E7
.0040103A: E880000000 call    .0004010BF --E3
.0040103F: 83C404     add     esp,4
.00401042: 5D        6pop    ebp
.00401043: C3        retn    ; ^.^.^.^.^.^.^.^.^.^.^.^.^.^.^.^
.00401044: CC        int     3
.00401045: CC        int     3
.00401046: CC        int     3
.00401047: CC        int     3
.00401048: CC        int     3
1Global 2FilBlk 3CryBlk 4ReLoad 5OrdLdr 6String 7Direct 8Table 91byte 10Leave 11Naked 12AddNam
```

Figure 1.41: Hiew: `f_unsigned()` function

Essentially, we have to accomplish three tasks:

- force the first jump to always trigger;
- force the second jump to never trigger;
- force the third jump to always trigger.

Thus we can direct the code flow to always pass through the second `printf()`, and output “a==b”.

Three instructions (or bytes) has to be patched:

- The first jump becomes `JMP`, but the [jump offset](#) would remain the same.
- The second jump might be triggered sometimes, but in any case it will jump to the next instruction, because, we set the [jump offset](#) to 0.

In these instructions the [jump offset](#) is added to the address for the next instruction. So if the offset is 0, the jump will transfer the control to the next instruction.

- The third jump we replace with `JMP` just as we do with the first one, so it will always trigger.

Here is the modified code:

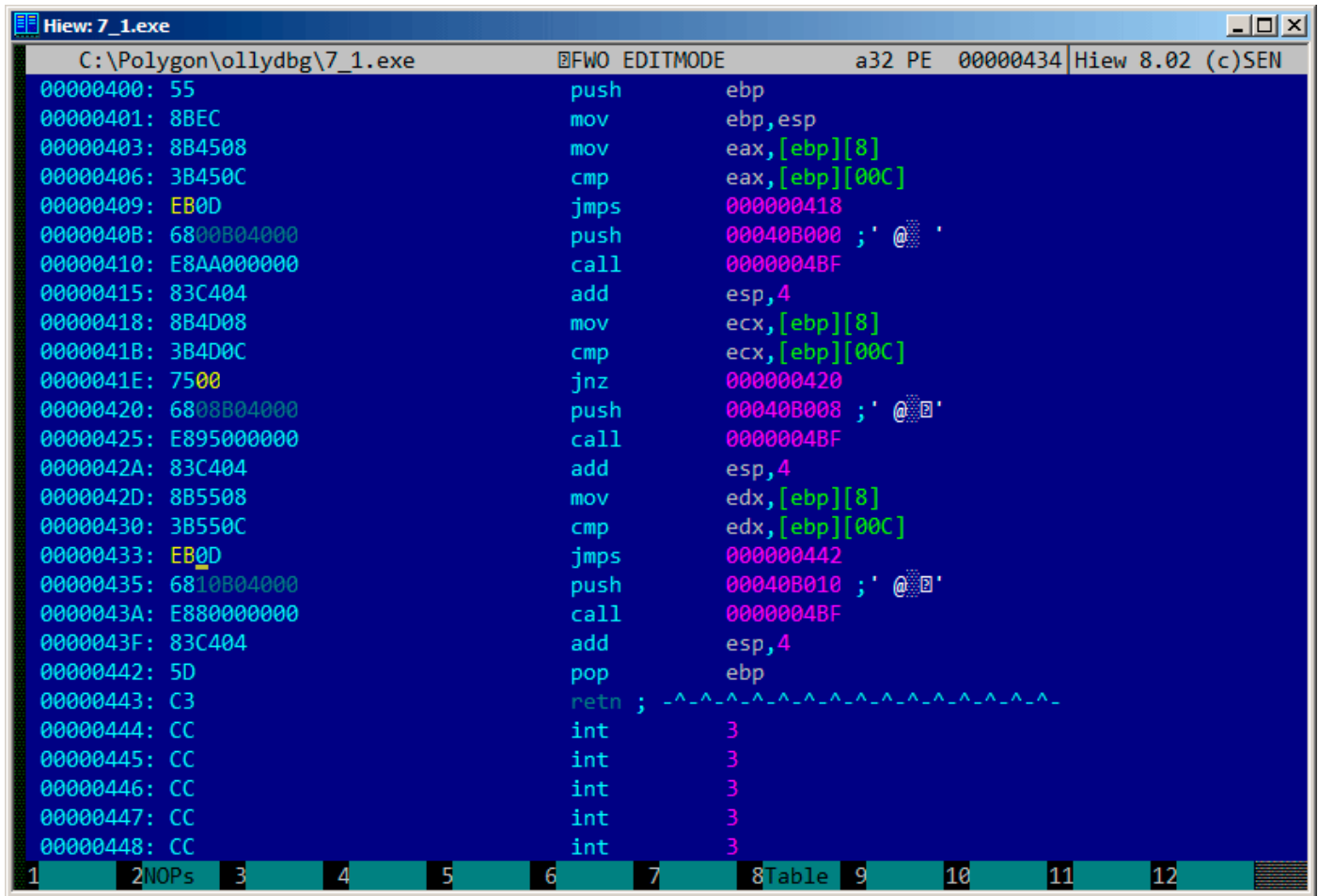

Figure 1.42: Hiew: let's modify the f\_unsigned() function

If we miss to change any of these jumps, then several printf() calls may execute, while we want to execute only one.

### Non-optimizing GCC

Non-optimizing GCC 4.4.1 produces almost the same code, but with puts() ( 1.5.3 on page 20) instead of printf().

### Optimizing GCC

An observant reader may ask, why execute CMP several times, if the flags has the same values after each execution?

Perhaps optimizing MSVC cannot do this, but optimizing GCC 4.8.1 can go deeper:

Listing 1.113: GCC 4.8.1 f\_signed()

```
f_signed:
    mov     eax, DWORD PTR [esp+8]
    cmp     DWORD PTR [esp+4], eax
    jg     .L6
    je     .L7
    jge    .L1
    mov     DWORD PTR [esp+4], OFFSET FLAT:.LC2 ; "a<b"
    jmp     puts
.L6:
    mov     DWORD PTR [esp+4], OFFSET FLAT:.LC0 ; "a>b"
    jmp     puts
```



```
.L1:
    rep ret
.L7:
    mov     DWORD PTR [esp+4], OFFSET FLAT:.LC1 ; "a==b"
    jmp     puts
```

We also see JMP puts here instead of CALL puts / RETN.

This kind of trick will have explained later: [1.21.1 on page 156](#).

This type of x86 code is somewhat rare. MSVC 2012 as it seems, can't generate such code. On the other hand, assembly language programmers are fully aware of the fact that Jcc instructions can be stacked.

So if you see such stacking somewhere, it is highly probable that the code was hand-written.

The f\_unsigned() function is not that aesthetically short:

Listing 1.114: GCC 4.8.1 f\_unsigned()

```
f_unsigned:
    push    esi
    push    ebx
    sub     esp, 20
    mov     esi, DWORD PTR [esp+32]
    mov     ebx, DWORD PTR [esp+36]
    cmp     esi, ebx
    ja     .L13
    cmp     esi, ebx ; this instruction could be removed
    je     .L14
.L10:
    jb     .L15
    add     esp, 20
    pop     ebx
    pop     esi
    ret
.L15:
    mov     DWORD PTR [esp+32], OFFSET FLAT:.LC2 ; "a<b"
    add     esp, 20
    pop     ebx
    pop     esi
    jmp     puts
.L13:
    mov     DWORD PTR [esp], OFFSET FLAT:.LC0 ; "a>b"
    call   puts
    cmp     esi, ebx
    jne    .L10
.L14:
    mov     DWORD PTR [esp+32], OFFSET FLAT:.LC1 ; "a==b"
    add     esp, 20
    pop     ebx
    pop     esi
    jmp     puts
```

Nevertheless, there are two CMP instructions instead of three.

So optimization algorithms of GCC 4.8.1 are probably not perfect yet.

## ARM

### 32-bit ARM

#### Optimizing Keil 6/2013 (ARM mode)

Listing 1.115: Optimizing Keil 6/2013 (ARM mode)

```
.text:000000B8          EXPORT f_signed
.text:000000B8          f_signed          ; CODE XREF: main+C
.text:000000B8 70 40 2D E9          STMFDD   SP!, {R4-R6,LR}
.text:000000BC 01 40 A0 E1          MOV      R4, R1
```

```

.text:000000C0 04 00 50 E1      CMP     R0, R4
.text:000000C4 00 50 A0 E1      MOV     R5, R0
.text:000000C8 1A 0E 8F C2      ADRGT  R0, aAB      ; "a>b\n"
.text:000000CC A1 18 00 CB      BLGT   __2printf
.text:000000D0 04 00 55 E1      CMP     R5, R4
.text:000000D4 67 0F 8F 02      ADREQ  R0, aAB_0    ; "a==b\n"
.text:000000D8 9E 18 00 0B      BLEQ   __2printf
.text:000000DC 04 00 55 E1      CMP     R5, R4
.text:000000E0 70 80 BD A8      LDMGEFD SP!, {R4-R6,PC}
.text:000000E4 70 40 BD E8      LDMFDD SP!, {R4-R6,LR}
.text:000000E8 19 0E 8F E2      ADR     R0, aAB_1    ; "a<b\n"
.text:000000EC 99 18 00 EA      B      __2printf
.text:000000EE      ; End of function f_signed

```

Many instructions in ARM mode could be executed only when specific flags are set. E.g. this is often used when comparing numbers.

For instance, the ADD instruction is in fact named ADDAL internally, where AL stands for *Always*, i.e., execute always. The predicates are encoded in 4 high bits of the 32-bit ARM instructions (*condition field*). The B instruction for unconditional jumping is in fact conditional and encoded just like any other conditional jump, but has AL in the *condition field*, and it implies *execute Always*, ignoring flags.

The ADRGT instruction works just like ADR but executes only in case the previous CMP instruction finds one of the numbers greater than the another, while comparing the two (*Greater Than*).

The next BLGT instruction behaves exactly as BL and is triggered only if the result of the comparison has been (*Greater Than*). ADRGT writes a pointer to the string a>b\n into R0 and BLGT calls printf(). Therefore, instructions suffixed with -GT are to execute only in case the value in R0 (which is *a*) is bigger than the value in R4 (which is *b*).

Moving forward we see the ADREQ and BLEQ instructions. They behave just like ADR and BL, but are to be executed only if operands were equal to each other during the last comparison. Another CMP is located before them (because the printf() execution may have tampered the flags).

Then we see LDMGEFD, this instruction works just like LDMFDD<sup>91</sup>, but is triggered only when one of the values is greater or equal than the other (*Greater or Equal*). The LDMGEFD SP!, {R4-R6,PC} instruction acts like a function epilogue, but it will be triggered only if  $a \geq b$ , and only then the function execution will finish.

But if that condition is not satisfied, i.e.,  $a < b$ , then the control flow will continue to the next "LDMFDD SP!, {R4-R6,LR}" instruction, which is one more function epilogue. This instruction restores not only the R4-R6 registers state, but also LR instead of PC, thus, it does not return from the function. The last two instructions call printf() with the string «a<b\n» as a sole argument. We already examined an unconditional jump to the printf() function instead of function return in «printf() with several arguments» section ( 1.11.2 on page 55).

f\_unsigned is similar, only the ADRHI, BLHI, and LDMCSFD instructions are used there, these predicates (*HI = Unsigned higher, CS = Carry Set (greater than or equal)*) are analogous to those examined before, but for unsigned values.

There is not much new in the main() function for us:

Listing 1.116: main()

```

.text:00000128      EXPORT main
.text:00000128      main
.text:00000128 10 40 2D E9      STMFD  SP!, {R4,LR}
.text:0000012C 02 10 A0 E3      MOV     R1, #2
.text:00000130 01 00 A0 E3      MOV     R0, #1
.text:00000134 DF FF FF EB      BL     f_signed
.text:00000138 02 10 A0 E3      MOV     R1, #2
.text:0000013C 01 00 A0 E3      MOV     R0, #1
.text:00000140 EA FF FF EB      BL     f_unsigned
.text:00000144 00 00 A0 E3      MOV     R0, #0
.text:00000148 10 80 BD E8      LDMFDD SP!, {R4,PC}
.text:0000014E      ; End of function main

```

That is how you can get rid of conditional jumps in ARM mode.

Why is this so good? Read here: [2.10.1 on page 466](#).

<sup>91</sup>LDMFDD

There is no such feature in x86, except the CMOVcc instruction, it is the same as MOV, but triggered only when specific flags are set, usually set by CMP.

## Optimizing Keil 6/2013 (Thumb mode)

Listing 1.117: Optimizing Keil 6/2013 (Thumb mode)

```
.text:00000072          f_signed ; CODE XREF: main+6
.text:00000072 70 B5          PUSH    {R4-R6,LR}
.text:00000074 0C 00          MOVS   R4, R1
.text:00000076 05 00          MOVS   R5, R0
.text:00000078 A0 42          CMP    R0, R4
.text:0000007A 02 DD          BLE    loc_82
.text:0000007C A4 A0          ADR    R0, aAB          ; "a>b\n"
.text:0000007E 06 F0 B7 F8    BL     __2printf
.text:00000082
.text:00000082          loc_82 ; CODE XREF: f_signed+8
.text:00000082 A5 42          CMP    R5, R4
.text:00000084 02 D1          BNE    loc_8C
.text:00000086 A4 A0          ADR    R0, aAB_0        ; "a==b\n"
.text:00000088 06 F0 B2 F8    BL     __2printf
.text:0000008C
.text:0000008C          loc_8C ; CODE XREF: f_signed+12
.text:0000008C A5 42          CMP    R5, R4
.text:0000008E 02 DA          BGE    locret_96
.text:00000090 A3 A0          ADR    R0, aAB_1        ; "a<b\n"
.text:00000092 06 F0 AD F8    BL     __2printf
.text:00000096
.text:00000096          locret_96 ; CODE XREF: f_signed+1C
.text:00000096 70 BD          POP    {R4-R6,PC}
.text:00000096          ; End of function f_signed
```

Only B instructions in Thumb mode may be supplemented by *condition codes*, so the Thumb code looks more ordinary.

BLE is a normal conditional jump *Less than or Equal*, BNE—*Not Equal*, BGE—*Greater than or Equal*.

f\_unsigned is similar, only other instructions are used while dealing with unsigned values: BLS (*Unsigned lower or same*) and BCS (*Carry Set (Greater than or equal)*).

## ARM64: Optimizing GCC (Linaro) 4.9

Listing 1.118: f\_signed()

```
f_signed:
; w0=a, w1=b
    cmp     w0, w1
    bgt    .L19    ; Branch if Greater Than (a>b)
    beq    .L20    ; Branch if Equal (a==b)
    bge    .L15    ; Branch if Greater than or Equal (a>=b) (impossible here)
; a<b
    adrp   x0, .LC11          ; "a<b"
    add    x0, x0, :lo12:LC11
    b      puts
.L19:
    adrp   x0, .LC9          ; "a>b"
    add    x0, x0, :lo12:LC9
    b      puts
.L15:
; impossible to get here
    ret
.L20:
    adrp   x0, .LC10          ; "a==b"
    add    x0, x0, :lo12:LC10
    b      puts
```

Listing 1.119: f\_unsigned()

```
f_unsigned:
```

```

    stp    x29, x30, [sp, -48]!
; w0=a, w1=b
    cmp    w0, w1
    add    x29, sp, 0
    str    x19, [sp,16]
    mov    w19, w0
    bhi    .L25    ; Branch if Higher (a>b)
    cmp    w19, w1
    beq    .L26    ; Branch if Equal (a==b)
.L23:
    bcc    .L27    ; Branch if Carry Clear (if less than) (a<b)
; function epilogue, impossible to be here
    ldr    x19, [sp,16]
    ldp    x29, x30, [sp], 48
    ret
.L27:
    ldr    x19, [sp,16]
    adrp   x0, .LC11    ; "a<b"
    ldp    x29, x30, [sp], 48
    add    x0, x0, :lo12:.LC11
    b      puts
.L25:
    adrp   x0, .LC9     ; "a>b"
    str    x1, [x29,40]
    add    x0, x0, :lo12:.LC9
    bl    puts
    ldr    x1, [x29,40]
    cmp    w19, w1
    bne   .L23    ; Branch if Not Equal
.L26:
    ldr    x19, [sp,16]
    adrp   x0, .LC10    ; "a==b"
    ldp    x29, x30, [sp], 48
    add    x0, x0, :lo12:.LC10
    b      puts

```

The comments were added by the author of this book. What is striking is that the compiler is not aware that some conditions are not possible at all, so there is dead code at some places, which can never be executed.

## Exercise

Try to optimize these functions manually for size, removing redundant instructions, without adding new ones.

## MIPS

One distinctive MIPS feature is the absence of flags. Apparently, it was done to simplify the analysis of data dependencies.

There are instructions similar to SETcc in x86: SLT (“Set on Less Than”: signed version) and SLTU (unsigned version). These instructions sets destination register value to 1 if the condition is true or to 0 if otherwise.

The destination register is then checked using BEQ (“Branch on Equal”) or BNE (“Branch on Not Equal”) and a jump may occur. So, this instruction pair has to be used in MIPS for comparison and branch. Let’s first start with the signed version of our function:

Listing 1.120: Non-optimizing GCC 4.4.5 (IDA)

```

.text:00000000 f_signed:                                     # CODE XREF: main+18
.text:00000000
.text:00000000 var_10          = -0x10
.text:00000000 var_8          = -8
.text:00000000 var_4          = -4
.text:00000000 arg_0          = 0
.text:00000000 arg_4          = 4
.text:00000000
.text:00000000          addiu   $sp, -0x20

```

```

.text:00000004      sw      $ra, 0x20+var_4($sp)
.text:00000008      sw      $fp, 0x20+var_8($sp)
.text:0000000C      move   $fp, $sp
.text:00000010      la      $gp, __gnu_local_gp
.text:00000018      sw      $gp, 0x20+var_10($sp)
; store input values into local stack:
.text:0000001C      sw      $a0, 0x20+arg_0($fp)
.text:00000020      sw      $a1, 0x20+arg_4($fp)
; reload them.
.text:00000024      lw      $v1, 0x20+arg_0($fp)
.text:00000028      lw      $v0, 0x20+arg_4($fp)
; $v0=b
; $v1=a
.text:0000002C      or      $at, $zero ; NOP
; this is pseudoinstruction. in fact, "slt $v0,$v0,$v1" is there.
; so $v0 will be set to 1 if $v0<$v1 (b<a) or to 0 if otherwise:
.text:00000030      slt    $v0, $v1
; jump to loc_5c, if condition is not true.
; this is pseudoinstruction. in fact, "beq $v0,$zero,loc_5c" is there:
.text:00000034      beqz   $v0, loc_5C
; print "a>b" and finish
.text:00000038      or      $at, $zero ; branch delay slot, NOP
.text:0000003C      lui    $v0, (unk_230 >> 16) # "a>b"
.text:00000040      addiu  $a0, $v0, (unk_230 & 0xFFFF) # "a>b"
.text:00000044      lw     $v0, (puts & 0xFFFF)($gp)
.text:00000048      or      $at, $zero ; NOP
.text:0000004C      move   $t9, $v0
.text:00000050      jalr   $t9
.text:00000054      or      $at, $zero ; branch delay slot, NOP
.text:00000058      lw     $gp, 0x20+var_10($fp)
.text:0000005C      loc_5C:                                     # CODE XREF: f_signed+34
.text:0000005C      lw     $v1, 0x20+arg_0($fp)
.text:00000060      lw     $v0, 0x20+arg_4($fp)
.text:00000064      or      $at, $zero ; NOP
; check if a==b, jump to loc_90 if its not true:
.text:00000068      bne    $v1, $v0, loc_90
.text:0000006C      or      $at, $zero ; branch delay slot, NOP
; condition is true, so print "a==b" and finish:
.text:00000070      lui    $v0, (aAB >> 16) # "a==b"
.text:00000074      addiu  $a0, $v0, (aAB & 0xFFFF) # "a==b"
.text:00000078      lw     $v0, (puts & 0xFFFF)($gp)
.text:0000007C      or      $at, $zero ; NOP
.text:00000080      move   $t9, $v0
.text:00000084      jalr   $t9
.text:00000088      or      $at, $zero ; branch delay slot, NOP
.text:0000008C      lw     $gp, 0x20+var_10($fp)
.text:00000090      loc_90:                                     # CODE XREF: f_signed+68
.text:00000090      lw     $v1, 0x20+arg_0($fp)
.text:00000094      lw     $v0, 0x20+arg_4($fp)
.text:00000098      or      $at, $zero ; NOP
; check if $v1<$v0 (a<b), set $v0 to 1 if condition is true:
.text:0000009C      slt    $v0, $v1, $v0
; if condition is not true (i.e., $v0==0), jump to loc_c8:
.text:000000A0      beqz   $v0, loc_c8
.text:000000A4      or      $at, $zero ; branch delay slot, NOP
; condition is true, print "a<b" and finish
.text:000000A8      lui    $v0, (aAB_0 >> 16) # "a<b"
.text:000000AC      addiu  $a0, $v0, (aAB_0 & 0xFFFF) # "a<b"
.text:000000B0      lw     $v0, (puts & 0xFFFF)($gp)
.text:000000B4      or      $at, $zero ; NOP
.text:000000B8      move   $t9, $v0
.text:000000BC      jalr   $t9
.text:000000C0      or      $at, $zero ; branch delay slot, NOP
.text:000000C4      lw     $gp, 0x20+var_10($fp)
.text:000000C8
; all 3 conditions were false, so just finish:
.text:000000C8      loc_c8:                                     # CODE XREF: f_signed+A0
.text:000000C8      move   $sp, $fp

```

```
.text:000000CC      lw      $ra, 0x20+var_4($sp)
.text:000000D0      lw      $fp, 0x20+var_8($sp)
.text:000000D4      addiu   $sp, 0x20
.text:000000D8      jr      $ra
.text:000000DC      or      $at, $zero ; branch delay slot, NOP
.text:000000DC      # End of function f_signed
```

SLT REG0, REG0, REG1 is reduced by IDA to its shorter form:  
SLT REG0, REG1.

We also see there BEQZ pseudo instruction (“Branch if Equal to Zero”),  
which are in fact BEQ REG, \$ZERO, LABEL.

The unsigned version is just the same, but SLTU (unsigned version, hence “U” in name) is used instead of  
SLT:

Listing 1.121: Non-optimizing GCC 4.4.5 (IDA)

```
.text:000000E0 f_unsigned:                                     # CODE XREF: main+28
.text:000000E0
.text:000000E0 var_10      = -0x10
.text:000000E0 var_8      = -8
.text:000000E0 var_4      = -4
.text:000000E0 arg_0      = 0
.text:000000E0 arg_4      = 4
.text:000000E0
.text:000000E0      addiu   $sp, -0x20
.text:000000E4      sw      $ra, 0x20+var_4($sp)
.text:000000E8      sw      $fp, 0x20+var_8($sp)
.text:000000EC      move   $fp, $sp
.text:000000F0      la     $gp, __gnu_local_gp
.text:000000F8      sw      $gp, 0x20+var_10($sp)
.text:000000FC      sw      $a0, 0x20+arg_0($fp)
.text:00000100      sw      $a1, 0x20+arg_4($fp)
.text:00000104      lw      $v1, 0x20+arg_0($fp)
.text:00000108      lw      $v0, 0x20+arg_4($fp)
.text:0000010C      or      $at, $zero
.text:00000110      sltu   $v0, $v1
.text:00000114      beqz   $v0, loc_13C
.text:00000118      or      $at, $zero
.text:0000011C      lui    $v0, (unk_230 >> 16)
.text:00000120      addiu   $a0, $v0, (unk_230 & 0xFFFF)
.text:00000124      lw      $v0, (puts & 0xFFFF)($gp)
.text:00000128      or      $at, $zero
.text:0000012C      move   $t9, $v0
.text:00000130      jalr   $t9
.text:00000134      or      $at, $zero
.text:00000138      lw      $gp, 0x20+var_10($fp)
.text:0000013C
.text:0000013C loc_13C:                                     # CODE XREF: f_unsigned+34
.text:0000013C      lw      $v1, 0x20+arg_0($fp)
.text:00000140      lw      $v0, 0x20+arg_4($fp)
.text:00000144      or      $at, $zero
.text:00000148      bne    $v1, $v0, loc_170
.text:0000014C      or      $at, $zero
.text:00000150      lui    $v0, (aAB >> 16) # "a==b"
.text:00000154      addiu   $a0, $v0, (aAB & 0xFFFF) # "a==b"
.text:00000158      lw      $v0, (puts & 0xFFFF)($gp)
.text:0000015C      or      $at, $zero
.text:00000160      move   $t9, $v0
.text:00000164      jalr   $t9
.text:00000168      or      $at, $zero
.text:0000016C      lw      $gp, 0x20+var_10($fp)
.text:00000170
.text:00000170 loc_170:                                     # CODE XREF: f_unsigned+68
.text:00000170      lw      $v1, 0x20+arg_0($fp)
.text:00000174      lw      $v0, 0x20+arg_4($fp)
.text:00000178      or      $at, $zero
.text:0000017C      sltu   $v0, $v1, $v0
.text:00000180      beqz   $v0, loc_1A8
.text:00000184      or      $at, $zero
```

```

.text:00000188          lui     $v0, (aAB_0 >> 16) # "a<b"
.text:0000018C          addiu  $a0, $v0, (aAB_0 & 0xFFFF) # "a<b"
.text:00000190          lw     $v0, (puts & 0xFFFF)($gp)
.text:00000194          or     $at, $zero
.text:00000198          move  $t9, $v0
.text:0000019C          jalr  $t9
.text:000001A0          or     $at, $zero
.text:000001A4          lw     $gp, 0x20+var_10($fp)
.text:000001A8          loc_1A8:                                # CODE XREF: f_unsigned+A0
.text:000001A8          move  $sp, $fp
.text:000001AC          lw     $ra, 0x20+var_4($sp)
.text:000001B0          lw     $fp, 0x20+var_8($sp)
.text:000001B4          addiu  $sp, 0x20
.text:000001B8          jr     $ra
.text:000001BC          or     $at, $zero
.text:000001BC          # End of function f_unsigned

```

## 1.18.2 Calculating absolute value

A simple function:

```

int my_abs (int i)
{
    if (i<0)
        return -i;
    else
        return i;
};

```

### Optimizing MSVC

This is how the code is usually generated:

Listing 1.122: Optimizing MSVC 2012 x64

```

i$ = 8
my_abs PROC
; ECX = input
    test    ecx, ecx
; check for sign of input value
; skip NEG instruction if sign is positive
    jns    SHORT $LN2@my_abs
; negate value
    neg    ecx
$LN2@my_abs:
; prepare result in EAX:
    mov    eax, ecx
    ret    0
my_abs ENDP

```

GCC 4.9 does mostly the same.

### Optimizing Keil 6/2013: Thumb mode

Listing 1.123: Optimizing Keil 6/2013: Thumb mode

```

my_abs PROC
    CMP     r0,#0
; is input value equal to zero or greater than zero?
; skip RSBS instruction then
    BGE    |L0.6|
; subtract input value from 0:
    RSBS   r0,r0,#0
|L0.6|
    BX     lr
ENDP

```

ARM lacks a negate instruction, so the Keil compiler uses the “Reverse Subtract” instruction, which just subtracts with reversed operands.

### Optimizing Keil 6/2013: ARM mode

It is possible to add condition codes to some instructions in ARM mode, so that is what the Keil compiler does:

Listing 1.124: Optimizing Keil 6/2013: ARM mode

```
my_abs PROC
    CMP        r0,#0
; execute "Reverse Subtract" instruction only if input value is less than 0:
    RSBLT     r0,r0,#0
    BX        lr
ENDP
```

Now there are no conditional jumps and this is good: [2.10.1 on page 466](#).

### Non-optimizing GCC 4.9 (ARM64)

ARM64 has instruction NEG for negating:

Listing 1.125: Optimizing GCC 4.9 (ARM64)

```
my_abs:
    sub       sp, sp, #16
    str       w0, [sp,12]
    ldr       w0, [sp,12]
; compare input value with contents of WZR register
; (which always holds zero)
    cmp       w0, wzr
    bge      .L2
    ldr       w0, [sp,12]
    neg       w0, w0
    b        .L3
.L2:
    ldr       w0, [sp,12]
.L3:
    add       sp, sp, 16
    ret
```

## MIPS

Listing 1.126: Optimizing GCC 4.4.5 (IDA)

```
my_abs:
; jump if $a0<0:
    bltz     $a0, locret_10
; just return input value ($a0) in $v0:
    move     $v0, $a0
    jr      $ra
    or      $at, $zero ; branch delay slot, NOP
locret_10:
; negate input value and store it in $v0:
    jr      $ra
; this is pseudoinstruction. in fact, this is "subu $v0,$zero,$a0" ($v0=0-$a0)
    negu    $v0, $a0
```

Here we see a new instruction: BLTZ (“Branch if Less Than Zero”).

There is also the NEGU pseudo instruction, which just does subtraction from zero. The “U” suffix in both SUBU and NEGU implies that no exception to be raised in case of integer overflow.

### Branchless version?

You could have also a branchless version of this code. This we will review later: [3.16 on page 521](#).



### 1.18.3 Ternary conditional operator

The ternary conditional operator in C/C++ has the following syntax:

```
expression ? expression : expression
```

Here is an example:

```
const char* f (int a)
{
    return a==10 ? "it is ten" : "it is not ten";
};
```

#### x86

Old and non-optimizing compilers generate assembly code just as if an if/else statement was used:

Listing 1.127: Non-optimizing MSVC 2008

```
$SG746 DB 'it is ten', 00H
$SG747 DB 'it is not ten', 00H

tv65 = -4 ; this will be used as a temporary variable
_a$ = 8
_f PROC
    push    ebp
    mov     ebp, esp
    push    ecx
; compare input value with 10
    cmp     DWORD PTR _a$[ebp], 10
; jump to $LN3@f if not equal
    jne     SHORT $LN3@f
; store pointer to the string into temporary variable:
    mov     DWORD PTR tv65[ebp], OFFSET $SG746 ; 'it is ten'
; jump to exit
    jmp     SHORT $LN4@f
$LN3@f:
; store pointer to the string into temporary variable:
    mov     DWORD PTR tv65[ebp], OFFSET $SG747 ; 'it is not ten'
$LN4@f:
; this is exit. copy pointer to the string from temporary variable to EAX.
    mov     eax, DWORD PTR tv65[ebp]
    mov     esp, ebp
    pop     ebp
    ret     0
_f ENDP
```

Listing 1.128: Optimizing MSVC 2008

```
$SG792 DB 'it is ten', 00H
$SG793 DB 'it is not ten', 00H

_a$ = 8 ; size = 4
_f PROC
; compare input value with 10
    cmp     DWORD PTR _a$[esp-4], 10
    mov     eax, OFFSET $SG792 ; 'it is ten'
; jump to $LN4@f if equal
    je     SHORT $LN4@f
    mov     eax, OFFSET $SG793 ; 'it is not ten'
$LN4@f:
    ret     0
_f ENDP
```

Newer compilers are more concise:

Listing 1.129: Optimizing MSVC 2012 x64

```

$SG1355 DB      'it is ten', 00H
$SG1356 DB      'it is not ten', 00H

a$ = 8
f      PROC
; load pointers to the both strings
    lea    rdx, OFFSET FLAT:$SG1355 ; 'it is ten'
    lea    rax, OFFSET FLAT:$SG1356 ; 'it is not ten'
; compare input value with 10
    cmp    ecx, 10
; if equal, copy value from RDX ("it is ten")
; if not, do nothing. pointer to the string "it is not ten" is still in RAX as for now.
    cmov  rax, rdx
    ret    0
f      ENDP

```

Optimizing GCC 4.8 for x86 also uses the CMOVcc instruction, while the non-optimizing GCC 4.8 uses conditional jumps.

## ARM

Optimizing Keil for ARM mode also uses the conditional instructions ADRcc:

Listing 1.130: Optimizing Keil 6/2013 (ARM mode)

```

f PROC
; compare input value with 10
    CMP    r0,#0xa
; if comparison result is Equal, copy pointer to the "it is ten" string into R0
    ADREQ  r0,|L0.16| ; "it is ten"
; if comparison result is Not Equal, copy pointer to the "it is not ten" string into R0
    ADRNE  r0,|L0.28| ; "it is not ten"
    BX    lr
    ENDP

|L0.16|
    DCB    "it is ten",0
|L0.28|
    DCB    "it is not ten",0

```

Without manual intervention, the two instructions ADREQ and ADRNE cannot be executed in the same run.

Optimizing Keil for Thumb mode needs to use conditional jump instructions, since there are no load instructions that support conditional flags:

Listing 1.131: Optimizing Keil 6/2013 (Thumb mode)

```

f PROC
; compare input value with 10
    CMP    r0,#0xa
; jump to |L0.8| if Equal
    BEQ    |L0.8|
    ADR    r0,|L0.12| ; "it is not ten"
    BX    lr
|L0.8|
    ADR    r0,|L0.28| ; "it is ten"
    BX    lr
    ENDP

|L0.12|
    DCB    "it is not ten",0
|L0.28|
    DCB    "it is ten",0

```

## ARM64

Optimizing GCC (Linaro) 4.9 for ARM64 also uses conditional jumps:

### Listing 1.132: Optimizing GCC (Linaro) 4.9

```
f:
    cmp    x0, 10
    beq    .L3          ; branch if equal
    adrp   x0, .LC1     ; "it is ten"
    add    x0, x0, :lo12:LC1
    ret

.L3:
    adrp   x0, .LC0     ; "it is not ten"
    add    x0, x0, :lo12:LC0
    ret

.LC0:
    .string "it is ten"

.LC1:
    .string "it is not ten"
```

That is because ARM64 does not have a simple load instruction with conditional flags, like `ADRcc` in 32-bit ARM mode or `CMOVcc` in x86.

It has, however, “Conditional SElect” instruction (`CSEL`) [*ARM Architecture Reference Manual, ARMv8, for ARMv8-A architecture profile*, (2013)p390, C5.5], but GCC 4.9 does not seem to be smart enough to use it in such piece of code.

### MIPS

Unfortunately, GCC 4.4.5 for MIPS is not very smart, either:

### Listing 1.133: Optimizing GCC 4.4.5 (assembly output)

```
$LC0:
    .ascii "it is not ten\000"

$LC1:
    .ascii "it is ten\000"

f:
    li     $2,10        # 0xa
; compare $a0 and 10, jump if equal:
    beq    $4,$2,$L2
    nop    ; branch delay slot

; leave address of "it is not ten" string in $v0 and return:
    lui    $2,%hi($LC0)
    j      $31
    addiu  $2,$2,%lo($LC0)

$L2:
; leave address of "it is ten" string in $v0 and return:
    lui    $2,%hi($LC1)
    j      $31
    addiu  $2,$2,%lo($LC1)
```

### Let’s rewrite it in an if/else way

```
const char* f (int a)
{
    if (a==10)
        return "it is ten";
    else
        return "it is not ten";
};
```

Interestingly, optimizing GCC 4.8 for x86 was also able to use `CMOVcc` in this case:

### Listing 1.134: Optimizing GCC 4.8

```
.LC0:
    .string "it is ten"

.LC1:
    .string "it is not ten"

f:
```

```

.LFB0:
; compare input value with 10
    cmp     DWORD PTR [esp+4], 10
    mov     edx, OFFSET FLAT:.LC1 ; "it is not ten"
    mov     eax, OFFSET FLAT:.LC0 ; "it is ten"
; if comparison result is Not Equal, copy EDX value to EAX
; if not, do nothing
    cmovne eax, edx
    ret

```

Optimizing Keil in ARM mode generates code identical to listing.1.130.

But the optimizing MSVC 2012 is not that good (yet).

## Conclusion

Why optimizing compilers try to get rid of conditional jumps? Read here about it: [2.10.1 on page 466](#).

## 1.18.4 Getting minimal and maximal values

### 32-bit

```

int my_max(int a, int b)
{
    if (a>b)
        return a;
    else
        return b;
};

int my_min(int a, int b)
{
    if (a<b)
        return a;
    else
        return b;
};

```

Listing 1.135: Non-optimizing MSVC 2013

```

_a$ = 8
_b$ = 12
_my_min PROC
    push    ebp
    mov     ebp, esp
    mov     eax, DWORD PTR _a$[ebp]
; compare A and B:
    cmp     eax, DWORD PTR _b$[ebp]
; jump, if A is greater or equal to B:
    jge     SHORT $LN2@my_min
; reload A to EAX if otherwise and jump to exit
    mov     eax, DWORD PTR _a$[ebp]
    jmp     SHORT $LN3@my_min
    jmp     SHORT $LN3@my_min ; this is redundant JMP
$LN2@my_min:
; return B
    mov     eax, DWORD PTR _b$[ebp]
$LN3@my_min:
    pop     ebp
    ret     0
_my_min ENDP

_a$ = 8
_b$ = 12
_my_max PROC
    push    ebp
    mov     ebp, esp
    mov     eax, DWORD PTR _a$[ebp]
; compare A and B:

```

```

    cmp    eax, DWORD PTR _b$[ebp]
; jump if A is less or equal to B:
    jle    SHORT $LN2@my_max
; reload A to EAX if otherwise and jump to exit
    mov    eax, DWORD PTR _a$[ebp]
    jmp    SHORT $LN3@my_max
    jmp    SHORT $LN3@my_max ; this is redundant JMP
$LN2@my_max:
; return B
    mov    eax, DWORD PTR _b$[ebp]
$LN3@my_max:
    pop    ebp
    ret    0
_my_max ENDP

```

These two functions differ only in the conditional jump instruction: JGE (“Jump if Greater or Equal”) is used in the first one and JLE (“Jump if Less or Equal”) in the second.

There is one unneeded JMP instruction in each function, which MSVC presumably left by mistake.

## Branchless

ARM for Thumb mode reminds us of x86 code:

Listing 1.136: Optimizing Keil 6/2013 (Thumb mode)

```

my_max PROC
; R0=A
; R1=B
; compare A and B:
    CMP    r0,r1
; branch if A is greater then B:
    BGT    |L0.6|
; otherwise (A<=B) return R1 (B):
    MOVS   r0,r1
|L0.6|
; return
    BX    lr
    ENDP

my_min PROC
; R0=A
; R1=B
; compare A and B:
    CMP    r0,r1
; branch if A is less then B:
    BLT    |L0.14|
; otherwise (A>=B) return R1 (B):
    MOVS   r0,r1
|L0.14|
; return
    BX    lr
    ENDP

```

The functions differ in the branching instruction: BGT and BLT. It’s possible to use conditional suffixes in ARM mode, so the code is shorter.

MOVcc is to be executed only if the condition is met:

Listing 1.137: Optimizing Keil 6/2013 (ARM mode)

```

my_max PROC
; R0=A
; R1=B
; compare A and B:
    CMP    r0,r1
; return B instead of A by placing B in R0
; this instruction will trigger only if A<=B (hence, LE - Less or Equal)
; if instruction is not triggered (in case of A>B), A is still in R0 register
    MOVLE  r0,r1

```

```

        BX      lr
        ENDP

my_min PROC
; R0=A
; R1=B
; compare A and B:
        CMP     r0,r1
; return B instead of A by placing B in R0
; this instruction will trigger only if A>=B (hence, GE - Greater or Equal)
; if instruction is not triggered (in case of A<B), A value is still in R0 register
        MOVGE   r0,r1
        BX      lr
        ENDP

```

Optimizing GCC 4.8.1 and optimizing MSVC 2013 can use CMOVcc instruction, which is analogous to MOVcc in ARM:

Listing 1.138: Optimizing MSVC 2013

```

my_max:
        mov     edx, DWORD PTR [esp+4]
        mov     eax, DWORD PTR [esp+8]
; EDX=A
; EAX=B
; compare A and B:
        cmp     edx, eax
; if A>=B, load A value into EAX
; the instruction idle if otherwise (if A<B)
        cmovge eax, edx
        ret

my_min:
        mov     edx, DWORD PTR [esp+4]
        mov     eax, DWORD PTR [esp+8]
; EDX=A
; EAX=B
; compare A and B:
        cmp     edx, eax
; if A<=B, load A value into EAX
; the instruction idle if otherwise (if A>B)
        cmovle eax, edx
        ret

```

## 64-bit

```

#include <stdint.h>

int64_t my_max(int64_t a, int64_t b)
{
    if (a>b)
        return a;
    else
        return b;
};

int64_t my_min(int64_t a, int64_t b)
{
    if (a<b)
        return a;
    else
        return b;
};

```

There is some unneeded value shuffling, but the code is comprehensible:

Listing 1.139: Non-optimizing GCC 4.9.1 ARM64

```

my_max:

```

```

    sub    sp, sp, #16
    str    x0, [sp,8]
    str    x1, [sp]
    ldr    x1, [sp,8]
    ldr    x0, [sp]
    cmp    x1, x0
    ble   .L2
    ldr    x0, [sp,8]
    b     .L3
.L2:
    ldr    x0, [sp]
.L3:
    add    sp, sp, 16
    ret

my_min:
    sub    sp, sp, #16
    str    x0, [sp,8]
    str    x1, [sp]
    ldr    x1, [sp,8]
    ldr    x0, [sp]
    cmp    x1, x0
    bge   .L5
    ldr    x0, [sp,8]
    b     .L6
.L5:
    ldr    x0, [sp]
.L6:
    add    sp, sp, 16
    ret

```

## Branchless

No need to load function arguments from the stack, as they are already in the registers:

Listing 1.140: Optimizing GCC 4.9.1 x64

```

my_max:
; RDI=A
; RSI=B
; compare A and B:
    cmp    rdi, rsi
; prepare B in RAX for return:
    mov    rax, rsi
; if A>=B, put A (RDI) in RAX for return.
; this instruction is idle if otherwise (if A<B)
    cmovge rax, rdi
    ret

my_min:
; RDI=A
; RSI=B
; compare A and B:
    cmp    rdi, rsi
; prepare B in RAX for return:
    mov    rax, rsi
; if A<=B, put A (RDI) in RAX for return.
; this instruction is idle if otherwise (if A>B)
    cmovle rax, rdi
    ret

```

MSVC 2013 does almost the same.

ARM64 has the CSEL instruction, which works just as MOVcc in ARM or CMOVcc in x86, just the name is different: "Conditional SElect".

Listing 1.141: Optimizing GCC 4.9.1 ARM64

```

my_max:

```

```

; X0=A
; X1=B
; compare A and B:
    cmp    x0, x1
; select X0 (A) to X0 if X0>=X1 or A>=B (Greater or Equal)
; select X1 (B) to X0 if A<B
    csel   x0, x0, x1, ge
    ret

my_min:
; X0=A
; X1=B
; compare A and B:
    cmp    x0, x1
; select X0 (A) to X0 if X0<=X1 or A<=B (Less or Equal)
; select X1 (B) to X0 if A>B
    csel   x0, x0, x1, le
    ret

```

## MIPS

Unfortunately, GCC 4.4.5 for MIPS is not that good:

Listing 1.142: Optimizing GCC 4.4.5 (IDA)

```

my_max:
; set $v1 to 1 if $a1<$a0, or clear otherwise (if $a1>$a0):
    slt    $v1, $a1, $a0
; jump, if $v1 is 0 (or $a1>$a0):
    beqz   $v1, locret_10
; this is branch delay slot
; prepare $a1 in $v0 in case of branch triggered:
    move   $v0, $a1
; no branch triggered, prepare $a0 in $v0:
    move   $v0, $a0

locret_10:
    jr     $ra
    or     $at, $zero ; branch delay slot, NOP

; the min() function is same, but input operands in SLT instruction are swapped:
my_min:
    slt    $v1, $a0, $a1
    beqz   $v1, locret_28
    move   $v0, $a1
    move   $v0, $a0

locret_28:
    jr     $ra
    or     $at, $zero ; branch delay slot, NOP

```

Do not forget about the *branch delay slots*: the first MOVE is executed *before* BEQZ, the second MOVE is executed only if the branch hasn't been taken.

## 1.18.5 Conclusion

### x86

Here's the rough skeleton of a conditional jump:

Listing 1.143: x86

```

CMP register, register/value
Jcc true ; cc=condition code
false:
... some code to be executed if comparison result is false ...
JMP exit

```



```
true:
... some code to be executed if comparison result is true ...
exit:
```

## ARM

Listing 1.144: ARM

```
CMP register, register/value
Bcc true ; cc=condition code
false:
... some code to be executed if comparison result is false ...
JMP exit
true:
... some code to be executed if comparison result is true ...
exit:
```

## MIPS

Listing 1.145: Check for zero

```
BEQZ REG, label
...
```

Listing 1.146: Check for less than zero using pseudoinstruction

```
BLTZ REG, label
...
```

Listing 1.147: Check for equal values

```
BEQ REG1, REG2, label
...
```

Listing 1.148: Check for non-equal values

```
BNE REG1, REG2, label
...
```

Listing 1.149: Check for less than (signed)

```
SLT REG1, REG2, REG3
BEQ REG1, label
...
```

Listing 1.150: Check for less than (unsigned)

```
SLTU REG1, REG2, REG3
BEQ REG1, label
...
```

## Branchless

If the body of a condition statement is very short, the conditional move instruction can be used: MOVcc in ARM (in ARM mode), CSEL in ARM64, CMOVcc in x86.

## ARM

It's possible to use conditional suffixes in ARM mode for some instructions:

Listing 1.151: ARM (ARM mode)

```
CMP register, register/value
instr1_cc ; some instruction will be executed if condition code is true
instr2_cc ; some other instruction will be executed if other condition code is true
... etc...
```

Of course, there is no limit for the number of instructions with conditional code suffixes, as long as the CPU flags are not modified by any of them.

Thumb mode has the IT instruction, allowing to add conditional suffixes to the next four instructions. Read more about it: [1.25.7 on page 260](#).

Listing 1.152: ARM (Thumb mode)

```
CMP register, register/value
ITEEE EQ ; set these suffixes: if-then-else-else-else
instr1   ; instruction will be executed if condition is true
instr2   ; instruction will be executed if condition is false
instr3   ; instruction will be executed if condition is false
instr4   ; instruction will be executed if condition is false
```

### 1.18.6 Exercise

(ARM64) Try rewriting the code in [listing.1.132](#) by removing all conditional jump instructions and using the CSEL instruction.

## 1.19 Software cracking

The vast majority of software can be cracked like that — by searching the very place where protection is checked, a dongle ( [8.8 on page 829](#)), license key, serial number, etc.

Often, it looks like:

```
...
call check_protection
jz   all_OK
call message_box_protection_missing
call exit
all_OK:
; proceed
...
```

So if you see a patch (or “crack”), that cracks a software, and that patch replaces 0x74/0x75 (JZ/JNZ) byte(s) by 0xEB (JMP), this is it.

The process of software cracking comes down to a search of that JMP.

---

There are also a cases, when a software checks protection from time to time, this can be a dongle, or a license server can be queried through the Internet. Then you have to look for a function that checks protection. Then to patch it, to put there `xor eax, eax / retn`, or `mov eax, 1 / retn`.

It's important to understand that after patching of function beginning, usually, a garbage follows these two instructions. The garbage consists of part of one instruction and the several next instructions.

This is a real case. The beginning of a function which we want to *replace* by `return 1`;

Listing 1.153: Before

```

8BFF      mov     edi,edi
55        push   ebp
8BEC      mov     ebp,esp
81EC68080000 sub    esp,000000868
A110C00001 mov     eax,[00100C010]
33C5      xor     eax,ebp
8945FC    mov     [ebp][-4],eax
53        push   ebx
8B5D08    mov     ebx,[ebp][8]
...

```

Listing 1.154: After

```

B801000000 mov    eax,1
C3        retn
EC        in     al,dx
68080000A1 push  0A1000008
10C0      adc    al,al
0001      add    [ecx],al
33C5      xor    eax,ebp
8945FC    mov    [ebp][-4],eax
53        push  ebx
8B5D08    mov    ebx,[ebp][8]
...

```

Several incorrect instructions appears — IN, PUSH, ADC, ADD, after which, Hiew disassembler (which I just used) synchronized and continued to disassemble all the rest.

This is not important — all these instructions followed RETN will never be executed, unless a direct jump would occur from some place, and that wouldn't be possible in general case.

---

Also, a global boolean variable can be present, having a flag, was the software registered or not.

```

init_etc proc
...
call check_protection_or_license_file
mov  is_demo, eax
...
retn
init_etc endp

...

save_file proc
...
mov  eax, is_demo
cmp  eax, 1
jz   all_OK1

call message_box_it_is_a_demo_no_saving_allowed
retn

:all_OK1
; continue saving file

...

save_proc endp

somewhere_else proc

mov  eax, is_demo
cmp  eax, 1
jz   all_OK

```

```

; check if we run for 15 minutes
; exit if it is so
; or show nagging screen

:all_OK2
; continue

somewhere_else endp

```

A beginning of the `check_protection_or_license_file()` function could be patched, so that it will always return 1, or, if this is better by some reason, all JZ/JNZ instructions can be patched as well.

More about patching: [11.1](#).

## 1.20 Impossible shutdown practical joke (Windows 7)

I don't quite remember how I found the `ExitWindowsEx()` function in Windows 98's (it was late 1990s) `user32.dll` file. Probably, I just spotted its self-describing name. And then I tried to *block* it by patching its beginning by `0xC3` byte (RETN).

The result was funny: Windows 98 cannot be shutted down anymore. Had to press reset button.

These days I tried to do the same in Windows 7, that was created almost 10 years later and based on completely different Windows NT base. Still, `ExitWindowsEx()` function present in `user32.dll` file and serves the same purpose.

First, I turned off *Windows File Protection* by adding this to registry (Windows would silently restore modified system files otherwise):

```

Windows Registry Editor Version 5.00

[HKEY_LOCAL_MACHINE\SOFTWARE\Microsoft\Windows NT\CurrentVersion\Winlogon]
"SFCDisable"=dword:ffffff9d

```

Then I renamed `c:\windows\system32\user32.dll` to `user32.dll.bak`. I found `ExitWindowsEx()` export entry using Hiew (IDA can help as well) and put `0xC3` byte here. I restarted by Windows 7 and now it can't be shutted down. "Restart" and "Logoff" buttons don't work anymore.

I don't know if it's funny today or not, but back then, in late 1990s, my friend took patched `user32.dll` file on a floppy diskette and copied it to all the computers (within his reach, that worked under Windows 98 (almost all)) at his university. No Windows can be shutted down after and his computer science teacher was lurid. (Hopefully he can forgive us if he is reading this right now.)

If you do this, backup everything. The best idea is to run Windows under a virtual machine.

## 1.21 switch()/case/default

### 1.21.1 Small number of cases

```

#include <stdio.h>

void f (int a)
{
    switch (a)
    {
        case 0: printf ("zero\n"); break;
        case 1: printf ("one\n"); break;
        case 2: printf ("two\n"); break;
        default: printf ("something unknown\n"); break;
    };
};

int main()
{
    f (2); // test
}

```

```
};
```

## x86

### Non-optimizing MSVC

Result (MSVC 2010):

Listing 1.155: MSVC 2010

```
tv64 = -4 ; size = 4
_a$ = 8 ; size = 4
_f PROC
    push    ebp
    mov     ebp, esp
    push    ecx
    mov     eax, DWORD PTR _a$[ebp]
    mov     DWORD PTR tv64[ebp], eax
    cmp     DWORD PTR tv64[ebp], 0
    je      SHORT $LN4@f
    cmp     DWORD PTR tv64[ebp], 1
    je      SHORT $LN3@f
    cmp     DWORD PTR tv64[ebp], 2
    je      SHORT $LN2@f
    jmp     SHORT $LN1@f
$LN4@f:
    push    OFFSET $SG739 ; 'zero', 0aH, 00H
    call    _printf
    add     esp, 4
    jmp     SHORT $LN7@f
$LN3@f:
    push    OFFSET $SG741 ; 'one', 0aH, 00H
    call    _printf
    add     esp, 4
    jmp     SHORT $LN7@f
$LN2@f:
    push    OFFSET $SG743 ; 'two', 0aH, 00H
    call    _printf
    add     esp, 4
    jmp     SHORT $LN7@f
$LN1@f:
    push    OFFSET $SG745 ; 'something unknown', 0aH, 00H
    call    _printf
    add     esp, 4
$LN7@f:
    mov     esp, ebp
    pop     ebp
    ret     0
_f        ENDP
```

Our function with a few cases in switch() is in fact analogous to this construction:

```
void f (int a)
{
    if (a==0)
        printf ("zero\n");
    else if (a==1)
        printf ("one\n");
    else if (a==2)
        printf ("two\n");
    else
        printf ("something unknown\n");
};
```

If we work with switch() with a few cases it is impossible to be sure if it was a real switch() in the source code, or just a pack of if() statements.

This implies that switch() is like syntactic sugar for a large number of nested if()s.

There is nothing especially new to us in the generated code, with the exception of the compiler moving input variable *a* to a temporary local variable *tv64* <sup>92</sup>.

If we compile this in GCC 4.4.1, we'll get almost the same result, even with maximal optimization turned on (-O3 option).

## Optimizing MSVC

Now let's turn on optimization in MSVC (/Ox): `cl 1.c /Fa1.asm /Ox`

Listing 1.156: MSVC

```
_a$ = 8 ; size = 4
_f PROC
    mov     eax, DWORD PTR _a$[esp-4]
    sub     eax, 0
    je      SHORT $LN4@f
    sub     eax, 1
    je      SHORT $LN3@f
    sub     eax, 1
    je      SHORT $LN2@f
    mov     DWORD PTR _a$[esp-4], OFFSET $SG791 ; 'something unknown', 0aH, 00H
    jmp     _printf
$LN2@f:
    mov     DWORD PTR _a$[esp-4], OFFSET $SG789 ; 'two', 0aH, 00H
    jmp     _printf
$LN3@f:
    mov     DWORD PTR _a$[esp-4], OFFSET $SG787 ; 'one', 0aH, 00H
    jmp     _printf
$LN4@f:
    mov     DWORD PTR _a$[esp-4], OFFSET $SG785 ; 'zero', 0aH, 00H
    jmp     _printf
_f ENDP
```

Here we can see some dirty hacks.

First: the value of *a* is placed in EAX and 0 is subtracted from it. Sounds absurd, but it is done to check if the value in EAX is 0. If yes, the ZF flag is to be set (e.g. subtracting from 0 is 0) and the first conditional jump JE (*Jump if Equal* or synonym JZ —*Jump if Zero*) is to be triggered and control flow is to be passed to the \$LN4@f label, where the 'zero' message is being printed. If the first jump doesn't get triggered, 1 is subtracted from the input value and if at some stage the result is 0, the corresponding jump is to be triggered.

And if no jump gets triggered at all, the control flow passes to `printf()` with string argument 'something unknown'.

Second: we see something unusual for us: a string pointer is placed into the *a* variable, and then `printf()` is called not via CALL, but via JMP. There is a simple explanation for that: the caller pushes a value to the stack and calls our function via CALL. CALL itself pushes the return address (RA) to the stack and does an unconditional jump to our function address. Our function at any point of execution (since it do not contain any instruction that moves the stack pointer) has the following stack layout:

- ESP—points to RA
- ESP+4—points to the *a* variable

On the other side, when we have to call `printf()` here we need exactly the same stack layout, except for the first `printf()` argument, which needs to point to the string. And that is what our code does.

It replaces the function's first argument with the address of the string and jumps to `printf()`, as if we didn't call our function `f()`, but directly `printf()`. `printf()` prints a string to `stdout` and then executes the RET instruction, which POPs RA from the stack and control flow is returned not to `f()` but rather to `f()`'s caller, bypassing the end of the `f()` function.

All this is possible because `printf()` is called right at the end of the `f()` function in all cases. In some way, it is similar to the `longjmp()` <sup>93</sup> function. And of course, it is all done for the sake of speed.

A similar case with the ARM compiler is described in “`printf()` with several arguments” section, here ( [1.11.2 on page 55](#) ).

<sup>92</sup>Local variables in stack are prefixed with `tv`—that's how MSVC names internal variables for its needs

<sup>93</sup>[wikipedia](#)

# OllyDbg

Since this example is tricky, let's trace it in OllyDbg.

OllyDbg can detect such switch() constructs, and it can add some useful comments. EAX is 2 at the beginning, that's the function's input value:

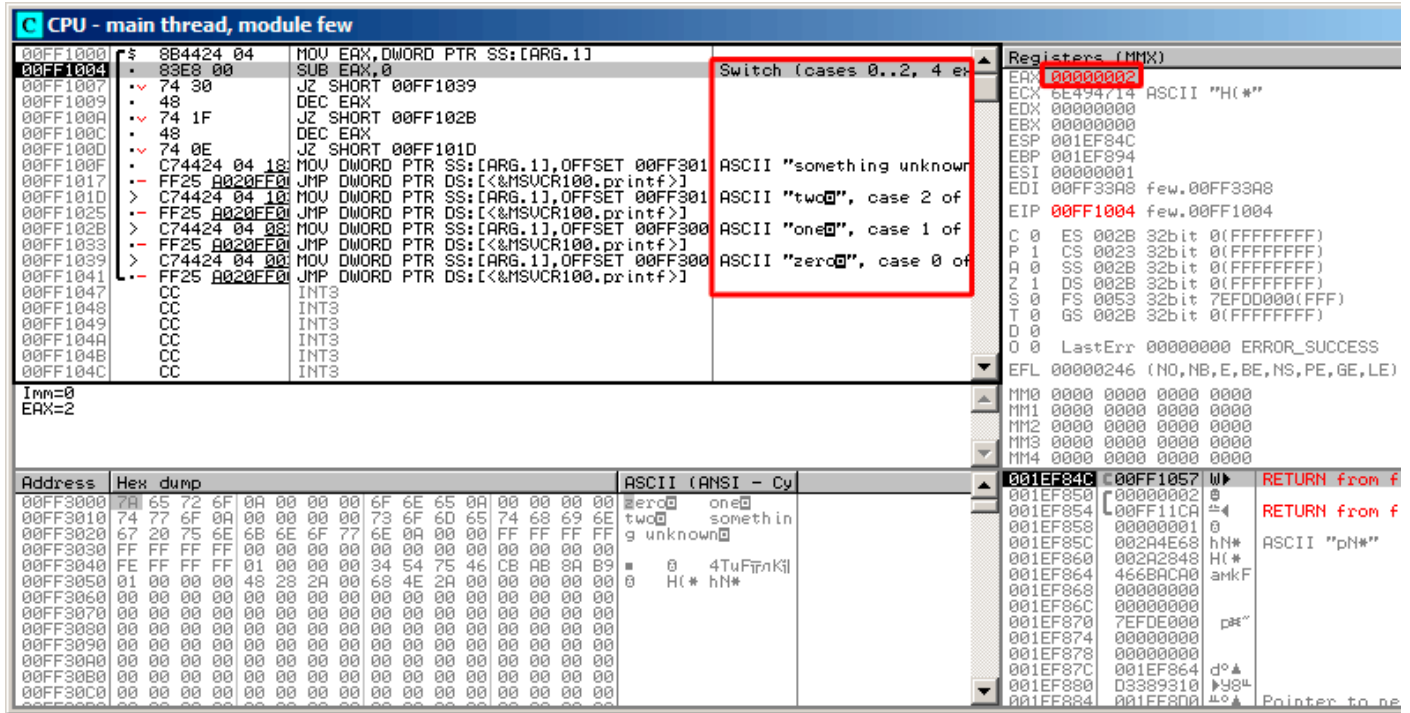

Figure 1.43: OllyDbg: EAX now contain the first (and only) function argument

0 is subtracted from 2 in EAX. Of course, EAX still contains 2. But the ZF flag is now 0, indicating that the resulting value is non-zero:

The screenshot shows the CPU window of OllyDbg for the main thread in module few. The assembly code at address 00FF1007 is highlighted, showing a JZ instruction that has been executed. The registers window on the right shows the ZF flag is 0, indicating a non-zero result. The memory dump at the bottom shows the ASCII output of the program, which is "zero", "one", "two", "something unknown", and "H(\* hN\* amkF p\* d° 984 \*▲ Pointer to p".

Address	Hex dump	ASCII (ANSI - Cy)
00FF3000	7A 65 72 6F 0A 00 00 00 6F 6E 65 0A 00 00 00 00	zero one
00FF3010	74 77 6F 0A 00 00 00 00 73 6F 6D 65 74 68 69 6E	two something
00FF3020	67 20 75 6E 68 6E 6F 77 6E 0A 00 00 FF FF FF FF	g unknown
00FF3030	FF FF FF FF 00 00 00 00 00 00 00 00 00 00 00 00	
00FF3040	FE FF FF FF 01 00 00 00 34 54 75 46 CB AB 8A B9	0 4TuFtnKl
00FF3050	01 00 00 00 48 28 2A 00 68 4E 2A 00 00 00 00 00	0 H(* hN*
00FF3060	00 00 00 00 00 00 00 00 00 00 00 00 00 00 00	
00FF3070	00 00 00 00 00 00 00 00 00 00 00 00 00 00 00	
00FF3080	00 00 00 00 00 00 00 00 00 00 00 00 00 00 00	
00FF3090	00 00 00 00 00 00 00 00 00 00 00 00 00 00 00	
00FF30A0	00 00 00 00 00 00 00 00 00 00 00 00 00 00 00	
00FF30B0	00 00 00 00 00 00 00 00 00 00 00 00 00 00 00	
00FF30C0	00 00 00 00 00 00 00 00 00 00 00 00 00 00 00	
00FF30D0	00 00 00 00 00 00 00 00 00 00 00 00 00 00 00	

Figure 1.44: OllyDbg: SUB executed



DEC is executed and EAX now contains 1. But 1 is non-zero, so the ZF flag is still 0:

**CPU - main thread, module few**

00FF1000	8B4424 04	MOV EAX,DWORD PTR SS:[ARG.1]	
00FF1004	83E8 00	SUB EAX,0	
00FF1007	74 30	JZ SHORT 00FF1039	Switch (cases 0..2, 4 ex
00FF1009	48	DEC EAX	
00FF100A	74 1F	JZ SHORT 00FF102B	
00FF100C	48	DEC EAX	
00FF100D	74 0E	JZ SHORT 00FF101D	
00FF100F	C74424 04 18	MOV DWORD PTR SS:[ARG.1],OFFSET 00FF301	ASCII "something unknown
00FF1017	FF25 0020EF0	JMP DWORD PTR DS:[<&MSUCR100.prIntf>]	
00FF101D	C74424 04 10	MOV DWORD PTR SS:[ARG.1],OFFSET 00FF301	ASCII "two", case 2 of
00FF1025	FF25 0020EF0	JMP DWORD PTR DS:[<&MSUCR100.prIntf>]	
00FF102B	C74424 04 08	MOV DWORD PTR SS:[ARG.1],OFFSET 00FF300	ASCII "one", case 1 of
00FF1033	FF25 0020EF0	JMP DWORD PTR DS:[<&MSUCR100.prIntf>]	
00FF1039	C74424 04 00	MOV DWORD PTR SS:[ARG.1],OFFSET 00FF300	ASCII "zero", case 0 of
00FF1041	FF25 0020EF0	JMP DWORD PTR DS:[<&MSUCR100.prIntf>]	
00FF1047	CC	INT3	
00FF1048	CC	INT3	
00FF1049	CC	INT3	
00FF104A	CC	INT3	
00FF104B	CC	INT3	
00FF104C	CC	INT3	

Registers (MMX)

EAX	00000001
ECX	6E494714 ASCII "H(*)"
EDX	00000000
EBX	00000000
ESP	001EF84C
EBP	001EF894
ESI	00000001
EDI	00FF33A8 few.00FF33A8
EIP	00FF100A few.00FF100A
C 0	ES 002B 32bit 0(FFFFFFFF)
P 0	CS 0023 32bit 0(FFFFFFFF)
D 0	DS 002B 32bit 0(FFFFFFFF)
S 0	SS 002B 32bit 0(FFFFFFFF)
T 0	FS 0053 32bit 7EFDD000(FFF)
D 0	GS 002B 32bit 0(FFFFFFFF)
LastErr	00000000 ERROR_SUCCESS
EFL	00000202 (NO,NB,NE,A,NS,PO,GE,G
MM0	0000 0000 0000 0000
MM1	0000 0000 0000 0000
MM2	0000 0000 0000 0000
MM3	0000 0000 0000 0000
MM4	0000 0000 0000 0000

Jump is not taken  
Dest=few.00FF102B

Address	Hex dump	ASCII (ANSI - Cy
00FF3000	65 72 6F 0A 00 00 00 6F 6E 65 0A 00 00 00 00	erc one
00FF3010	74 77 6F 0A 00 00 00 73 6F 6D 65 74 68 69 6E	two somethin
00FF3020	67 20 75 6E 68 6E 6F 77 6E 0A 00 00 FF FF FF FF	g unknown
00FF3030	FF FF FF FF 00 00 00 00 00 00 00 00 00 00 00 00	
00FF3040	FE FF FF FF 01 00 00 00 34 54 75 46 CB AB 8A B9	0 4TuF7nkI
00FF3050	01 00 00 00 48 28 2A 00 68 4E 2A 00 00 00 00 00	0 H(* hN*
00FF3060	00 00 00 00 00 00 00 00 00 00 00 00 00 00 00	
00FF3070	00 00 00 00 00 00 00 00 00 00 00 00 00 00 00	
00FF3080	00 00 00 00 00 00 00 00 00 00 00 00 00 00 00	
00FF3090	00 00 00 00 00 00 00 00 00 00 00 00 00 00 00	
00FF30A0	00 00 00 00 00 00 00 00 00 00 00 00 00 00 00	
00FF30B0	00 00 00 00 00 00 00 00 00 00 00 00 00 00 00	
00FF30C0	00 00 00 00 00 00 00 00 00 00 00 00 00 00 00	

Registers (MMX) (continued)

001EF84C	00FF1057	RETURN from
001EF850	00000002	
001EF854	00FF11CA	RETURN from
001EF858	00000001	
001EF85C	002A4E68	hN* ASCII "pN*"
001EF860	002A2848	H(*
001EF864	466BACA0	amkF
001EF868	00000000	
001EF86C	00000000	
001EF870	7EFDE000	p*"
001EF874	00000000	
001EF878	00000000	
001EF87C	001EF864	d°
001EF880	D3389310	48
001EF884	001EF8D0	Printer to

Figure 1.45: OllyDbg: first DEC executed

Next DEC is executed. EAX is finally 0 and the ZF flag gets set, because the result is zero:

**CPU - main thread, module few**

Address	Hex dump	Disassembly	Registers (MMX)
00FF1000	8B4424 04	MOV EAX,DWORD PTR SS:[ARG.1]	EAX 00000000
00FF1004	83E8 00	SUB EAX,0	EAX 00000000
00FF1007	74 30	JZ SHORT 00FF1039	EAX 00000000
00FF1009	48	DEC EAX	EAX 00000000
00FF100A	74 1F	JZ SHORT 00FF102B	EAX 00000000
00FF100C	48	DEC EAX	EAX 00000000
00FF100D	74 0E	JZ SHORT 00FF101D	EAX 00000000
00FF100F	C74424 04 18	MOV DWORD PTR SS:[ARG.1],OFFSET 00FF3018: ASCII "something unknown"	EAX 00000000
00FF1017	FF25 0020FF00	JMP DWORD PTR DS:[&MSUCR100.printf]	EAX 00000000
00FF101D	C74424 04 10	MOV DWORD PTR SS:[ARG.1],OFFSET 00FF3010: ASCII "two", case 2 of	EAX 00000000
00FF1025	FF25 0020FF00	JMP DWORD PTR DS:[&MSUCR100.printf]	EAX 00000000
00FF102B	C74424 04 08	MOV DWORD PTR SS:[ARG.1],OFFSET 00FF3008: ASCII "one", case 1 of	EAX 00000000
00FF1033	FF25 0020FF00	JMP DWORD PTR DS:[&MSUCR100.printf]	EAX 00000000
00FF1039	C74424 04 00	MOV DWORD PTR SS:[ARG.1],OFFSET 00FF3000: ASCII "zero", case 0 of	EAX 00000000
00FF1041	FF25 0020FF00	JMP DWORD PTR DS:[&MSUCR100.printf]	EAX 00000000
00FF1047	CC	INT3	EAX 00000000
00FF1048	CC	INT3	EAX 00000000
00FF1049	CC	INT3	EAX 00000000
00FF104A	CC	INT3	EAX 00000000
00FF104B	CC	INT3	EAX 00000000
00FF104C	CC	INT3	EAX 00000000

Registers (MMX):  
 EAX 00000000  
 ECX 6E434714 ASCII "H(\*"  
 EDI 00000000  
 ESI 00000001  
 EIP 00FF33A8 few.00FF33A8  
 EIP 00FF100D few.00FF100D  
 ZF 1  
 EFL 00000246 (NO,NB,E,BE,NS,PE,GE,LE)

Jump is taken  
 Dest=few.00FF101D

Address	Hex dump	ASCII (ANSI - Cy)
00FF3000	7A 65 72 6F 0A 00 00 00 6F 6E 65 0A 00 00 00 00	zero one
00FF3010	74 77 6F 0A 00 00 00 00 73 6F 6D 65 74 68 69 6E	two something unknown
00FF3020	67 20 75 6E 68 6E 6F 77 6E 0A 00 00 FF FF FF FF	
00FF3030	FF FF FF FF 00 00 00 00 00 00 00 00 00 00 00 00	
00FF3040	FE FF FF FF 01 00 00 00 34 54 75 46 CB AB 8A B9	0 4TuF7nKl
00FF3050	01 00 00 00 48 28 2A 00 68 4E 2A 00 00 00 00 00	0 H(* hN*
00FF3060	00 00 00 00 00 00 00 00 00 00 00 00 00 00 00 00	
00FF3070	00 00 00 00 00 00 00 00 00 00 00 00 00 00 00 00	
00FF3080	00 00 00 00 00 00 00 00 00 00 00 00 00 00 00 00	
00FF3090	00 00 00 00 00 00 00 00 00 00 00 00 00 00 00 00	
00FF30A0	00 00 00 00 00 00 00 00 00 00 00 00 00 00 00 00	
00FF30B0	00 00 00 00 00 00 00 00 00 00 00 00 00 00 00 00	
00FF30C0	00 00 00 00 00 00 00 00 00 00 00 00 00 00 00 00	

Figure 1.46: OllyDbg: second DEC executed

OllyDbg shows that this jump is to be taken now.

A pointer to the string "two" is to be written into the stack now:

**CPU - main thread, module few**

00FF1000	8B4424 04	MOV EAX,DWORD PTR SS:[ARG.1]			
00FF1004	83E8 00	SUB EAX,0			
00FF1007	74 30	JZ SHORT 00FF1039	Switch (cases 0..2, 4 ex		
00FF1009	48	DEC EAX			
00FF100A	74 1F	JZ SHORT 00FF102B			
00FF100C	48	DEC EAX			
00FF100D	74 0E	JZ SHORT 00FF101D			
00FF100F	C74424 04 18	MOV DWORD PTR SS:[ARG.1],OFFSET 00FF3010	ASCII "something unknown		
00FF1017	FF25 0020FF00	JMP DWORD PTR DS:[<&MSUCR100.printf>]			
00FF101D	C74424 04 10	MOV DWORD PTR SS:[ARG.1],OFFSET 00FF3010	ASCII "two", case 2 of		
00FF1025	FF25 0020FF00	JMP DWORD PTR DS:[<&MSUCR100.printf>]			
00FF102B	C74424 04 08	MOV DWORD PTR SS:[ARG.1],OFFSET 00FF3000	ASCII "one", case 1 of		
00FF1033	FF25 0020FF00	JMP DWORD PTR DS:[<&MSUCR100.printf>]			
00FF1039	C74424 04 00	MOV DWORD PTR SS:[ARG.1],OFFSET 00FF3000	ASCII "zero", case 0 of		
00FF1041	FF25 0020FF00	JMP DWORD PTR DS:[<&MSUCR100.printf>]			
00FF1047	CC	INT3			
00FF1048	CC	INT3			
00FF1049	CC	INT3			
00FF104A	CC	INT3			
00FF104B	CC	INT3			
00FF104C	CC	INT3			

Imm=few.00FF3010, ASCII "two"  
Stack [001EF850]=2  
Jump from 00FF100D

Address	Hex dump	ASCII (ANSI - Cy)			
00FF3000	7A 65 72 6F 0A 00 00 00 0F 6E 65 0A 00 00 00 00	zero one			
00FF3010	74 77 6F 0A 00 00 00 00 73 6F 6D 65 74 68 69 6E	two something			
00FF3020	67 20 75 6E 6B 6E 6F 77 6E 0A 00 00 FF FF FF FF	g unknown			
00FF3030	FF FF FF FF 00 00 00 00 00 00 00 00 00 00 00 00				
00FF3040	FE FF FF FF 01 00 00 00 34 54 75 46 CB AB 8A B9	= 0 4TuFtnkll			
00FF3050	01 00 00 00 48 28 2A 00 68 4E 2A 00 00 00 00 00	0 H(* hN*			
00FF3060	00 00 00 00 00 00 00 00 00 00 00 00 00 00 00				
00FF3070	00 00 00 00 00 00 00 00 00 00 00 00 00 00 00				
00FF3080	00 00 00 00 00 00 00 00 00 00 00 00 00 00 00				
00FF3090	00 00 00 00 00 00 00 00 00 00 00 00 00 00 00				
00FF30A0	00 00 00 00 00 00 00 00 00 00 00 00 00 00 00				
00FF30B0	00 00 00 00 00 00 00 00 00 00 00 00 00 00 00				
00FF30C0	00 00 00 00 00 00 00 00 00 00 00 00 00 00 00				

**Registers (MMX)**

EAX	00000000	
ECX	6E494714	ASCII "H(*"
EDX	00000000	
EBX	00000000	
ESP	001EF84C	
EBP	001EF894	
ESI	00000001	
EDI	00FF33A8	few.00FF33A8
EIP	00FF101D	few.00FF101D

**MMIO**

MM0	0000 0000 0000 0000
MM1	0000 0000 0000 0000
MM2	0000 0000 0000 0000
MM3	0000 0000 0000 0000
MM4	0000 0000 0000 0000

**Stack**

001EF850	00000002	RETURN from
001EF854	00FF11CA	RETURN from
001EF858	00000001	
001EF85C	002A4E68	hN*
001EF860	002A2848	H(*
001EF864	466BACA0	amkF
001EF868	00000000	
001EF86C	00000000	
001EF870	7EFDE000	p*"
001EF874	00000000	
001EF878	00000000	
001EF87C	001EF864	d°▲
001EF880	D3389310	Y8L
001EF884	001EF800	*°▲ Pointer to p

Figure 1.47: OllyDbg: pointer to the string is to be written at the place of the first argument

Please note: the current argument of the function is 2 and 2 is now in the stack at the address 0x001EF850.

MOV writes the pointer to the string at address 0x001EF850 (see the stack window). Then, jump happens. This is the first instruction of the printf() function in MSVCR100.DLL (This example was compiled with /MD switch):

The screenshot displays the OllyDbg interface for the main thread in the MSVCR100 module. The CPU window shows the following assembly instructions:

```

6E445584 6A 0C          PUSH 0C
6E445586 68 3056446E   PUSH 6E445630
6E445588 E9 C0B3FAFF   CALL 6E3F0950
6E445590 33C0         XOR EAX,EAX
6E445592 33F6         XOR ESI,ESI
6E445594 3975 08      CMP DWORD PTR SS:[EBP+8],ESI
6E445597 0F95C0      SETNE AL
6E445599 3BC6         CMP EAX,ESI
6E44559C 75 15       JNE SHORT 6E4455B3
6E44559E E8 72B2FAFF   CALL errno
6E4455A3 C700 16000000 MOV DWORD PTR DS:[EAX],16
6E4455A9 E8 D0590200   CALL invalid_parameter_noinfo
6E4455AE 83C8 FF     OR EAX,FFFFFFFF
6E4455B1 EB 5F       JMP SHORT 6E445612
6E4455B3 > E8 78E4FAFF   CALL _lob_func
6E4455B8 6A 20      PUSH 20
6E4455BA 5B        POP EBX
6E4455BB 03C3     ADD EAX,EBX
6E4455BD 50      PUSH EAX
6E4455BE 6A 01     PUSH 1
6E4455C0 E8 F453FBFF   CALL 6E3FA9B9
  
```

The registers window shows the following values:

```

Registers (MMX)
EAX 00000000
ECX 6E494714 ASCII "H(*"
EDX 00000000
EBX 00000000
ESP 001EF84C
EBP 001EF894
ESI 00000001
EDI 00FF33A8 few.00FF33A8
EIP 6E445584 MSVCR100.printf
  
```

The stack window shows the current instruction at 001EF848:

```

Stack [001EF848]=few.00FF3064
Inm=0000000C (decimal 12.)
MSVCR100.printf
  
```

The ASCII dump window shows the string 'one two something unknown' at address 00FF3000:

```

Address Hex dump ASCII (ANSI - Cy)
00FF3000 7A 65 72 6F 0A 00 00 00 6F 6E 65 0A 00 00 00 00 one
00FF3010 74 77 6F 0A 00 00 00 73 6F 6D 65 74 68 69 6E two something
00FF3020 67 20 75 6E 6B 6E 6F 77 6E 0A 00 00 FF FF FF FF g unknown
00FF3030 FF FF FF FF 00 00 00 00 00 00 00 00 00 00 00 00
00FF3040 FE FF FF FF 01 00 00 00 34 54 75 46 CB AB 8A B9
00FF3050 01 00 00 00 48 28 2A 00 68 4E 2A 00 00 00 00 00
00FF3060 00 00 00 00 00 00 00 00 00 00 00 00 00 00 00 00
00FF3070 00 00 00 00 00 00 00 00 00 00 00 00 00 00 00 00
00FF3080 00 00 00 00 00 00 00 00 00 00 00 00 00 00 00 00
00FF3090 00 00 00 00 00 00 00 00 00 00 00 00 00 00 00 00
00FF30A0 00 00 00 00 00 00 00 00 00 00 00 00 00 00 00 00
00FF30B0 00 00 00 00 00 00 00 00 00 00 00 00 00 00 00 00
00FF30C0 00 00 00 00 00 00 00 00 00 00 00 00 00 00 00 00
  
```

Figure 1.48: OllyDbg: first instruction of printf() in MSVCR100.DLL

Now printf() treats the string at 0x00FF3010 as its only argument and prints the string.

This is the last instruction of printf():

**CPU - main thread, module MSVCR100**

6E4455D0	• 50	PUSH EAX	
6E4455DE	• 56	PUSH ESI	
6E4455DF	• FF75 08	PUSH DWORD PTR SS:[EBP+8]	
6E4455E2	• E8 49E4FAFF	CALL __iob_func	
6E4455E7	• 03C3	ADD EAX,EBX	
6E4455E9	• 50	PUSH EAX	
6E4455EA	• E8 2E710100	CALL 6E45C71D	
6E4455EF	• 8945 E4	MOV DWORD PTR SS:[EBP-1C],EAX	
6E4455F2	• E8 39E4FAFF	CALL __iob_func	
6E4455F7	• 03C3	ADD EAX,EBX	
6E4455F9	• 50	PUSH EAX	
6E4455FA	• 57	PUSH EDI	
6E4455FB	• E8 ACB0FBFF	CALL 6E4006AC	Arg2 Arg1 MSVCR100.6E4006AC
6E445600	• 83C4 18	ADD ESP,18	
6E445603	• C745 FC FEFF	MOV DWORD PTR SS:[EBP-4],-2	
6E44560A	• E8 09000000	CALL 6E445618	
6E44560F	• 8B45 E4	MOV EAX,DWORD PTR SS:[EBP-1C]	
6E445612	• E8 7EB3FAFF	CALL 6E3F0995	
6E445617	• C3	RETN	
6E445618	• E8 13E4FAFF	CALL __iob_func	
6E44561D	• 83C0 20	ADD EAX,20	

Top of stack [001EF84C]=few.00FF1057

MSVCR100.printf+93

Address	Hex dump	ASCII (ANSI - Cy)
00FF3000	7A 65 72 6F 0A 00 00 00 6F 6E 65 0A 00 00 00 00	two one
00FF3010	74 77 6F 0A 00 00 00 00 73 6F 6D 65 74 68 69 6E	two something unknown
00FF3020	67 20 75 6E 68 6E 6F 77 6E 0A 00 00 FF FF FF FF	
00FF3030	FF FF FF FF 00 00 00 00 00 00 00 00 00 00 00 00	
00FF3040	FE FF FF FF 01 00 00 00 34 54 75 46 CB AB 8A B9	0 4TuF7nKj
00FF3050	01 00 00 00 48 28 2A 00 68 4E 2A 00 00 00 00 00	0 H(* hN*
00FF3060	00 00 00 00 00 00 00 00 00 00 00 00 00 00 00 00	
00FF3070	00 00 00 00 00 00 00 00 00 00 00 00 00 00 00 00	
00FF3080	00 00 00 00 00 00 00 00 00 00 00 00 00 00 00 00	
00FF3090	00 00 00 00 00 00 00 00 00 00 00 00 00 00 00 00	
00FF30A0	00 00 00 00 00 00 00 00 00 00 00 00 00 00 00 00	
00FF30B0	00 00 00 00 00 00 00 00 00 00 00 00 00 00 00 00	
00FF30C0	00 00 00 00 00 00 00 00 00 00 00 00 00 00 00 00	
00FF30D0	00 00 00 00 00 00 00 00 00 00 00 00 00 00 00 00	

**Registers (MMX)**

EAX	00000004
ECX	6E445617 MSVCR100.6E445617
EDX	0009DC88
EBX	00000000
ESP	001EF84C
EBP	001EF894
ESI	00000001
EDI	00FF33A8 few.00FF33A8
EIP	6E445617 MSVCR100.6E445617

**MMX**

MM0	0000 0000 0000 0000
MM1	0000 0000 0000 0000
MM2	0000 0000 0000 0000
MM3	0000 0000 0000 0000
MM4	0000 0000 0000 0000

**Registers (MMX) (continued)**

C 0	ES 002B 32bit 0(FFFFFFFF)
P 1	CS 0023 32bit 0(FFFFFFFF)
A 0	SS 002B 32bit 0(FFFFFFFF)
Z 1	DS 002B 32bit 0(FFFFFFFF)
S 0	FS 0053 32bit 7EFDD000(FFF)
T 0	GS 002B 32bit 0(FFFFFFFF)
D 0	
O 0	LastErr 00000000 ERROR_SUCCESS
EFL	00000246 (NO,NB,E,BE,NS,PE,GE,LE)

**Registers (MMX) (continued)**

001EF84C	00FF1057	00	RETURN from f
001EF850	00FF3010	00	ASCII "two"
001EF854	00FF11CA	00	RETURN from f
001EF858	00000001	00	
001EF85C	002A4E68	00	hN*
001EF860	002A2848	00	ASCII "pN**"
001EF864	466BAC00	00	H*
001EF868	00000000	00	ankF
001EF86C	00000000	00	
001EF870	7EFDE000	00	p**
001EF874	00000000	00	
001EF878	00000000	00	
001EF87C	001EF864	00	d*
001EF880	03399310	00	Y8L
001EF884	001EF800	00	Pointer to pe

Figure 1.49: OllyDbg: last instruction of printf() in MSVCR100.DLL

The string "two" has just been printed to the console window.

Now let's press F7 or F8 (step over) and return...not to f(), but rather to main():

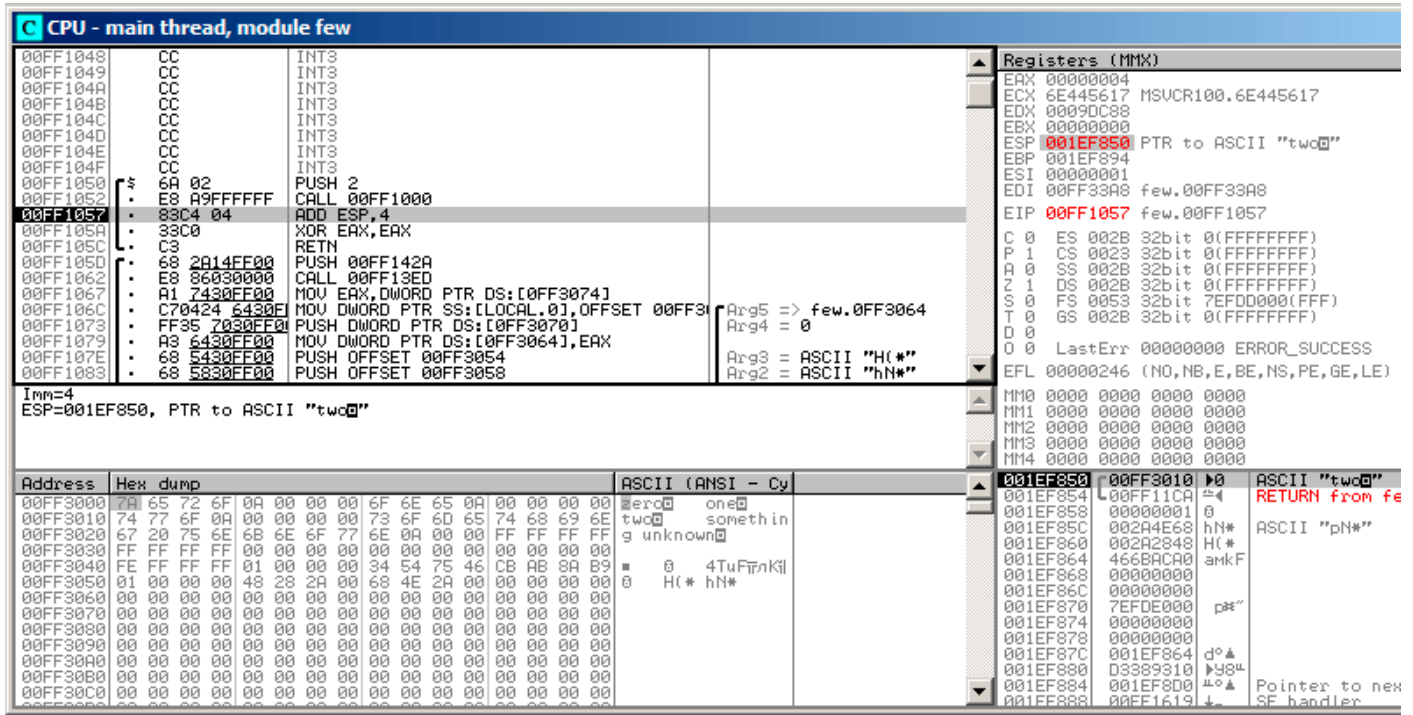

Figure 1.50: OllyDbg: return to main()

Yes, the jump has been direct, from the guts of printf() to main(). Because RA in the stack points not to some place in f(), but rather to main(). And CALL 0x00FF1000 has been the actual instruction which called f().

### ARM: Optimizing Keil 6/2013 (ARM mode)

```
.text:0000014C          f1:
.text:0000014C 00 00 50 E3      CMP     R0, #0
.text:00000150 13 0E 8F 02     ADREQ  R0, aZero ; "zero\n"
.text:00000154 05 00 00 0A     BEQ    loc_170
.text:00000158 01 00 50 E3      CMP     R0, #1
.text:0000015C 4B 0F 8F 02     ADREQ  R0, a0ne ; "one\n"
.text:00000160 02 00 00 0A     BEQ    loc_170
.text:00000164 02 00 50 E3      CMP     R0, #2
.text:00000168 4A 0F 8F 12     ADRNE  R0, aSomethingUnkno ; "something unknown\n"
.text:0000016C 4E 0F 8F 02     ADREQ  R0, aTwo ; "two\n"
.text:00000170
.text:00000170          loc_170: ; CODE XREF: f1+8
.text:00000170          ; f1+14
.text:00000170 78 18 00 EA     B      __2printf
```

Again, by investigating this code we cannot say if it was a switch() in the original source code, or just a pack of if() statements.

Anyway, we see here predicated instructions again (like ADREQ (Equal)) which is triggered only in case R0 = 0, and then loads the address of the string «zero\n» into R0. The next instruction BEQ redirects control flow to loc\_170, if R0 = 0.

An astute reader may ask, will BEQ trigger correctly since ADREQ it has already filled the R0 register before with another value?

Yes, it will since BEQ checks the flags set by the CMP instruction, and ADREQ does not modify any flags at all.

The rest of the instructions are already familiar to us. There is only one call to printf(), at the end, and we have already examined this trick here ( 1.11.2 on page 55). At the end, there are three paths to printf().

The last instruction, `CMP R0, #2`, is needed to check if  $a = 2$ .

If it is not true, then `ADRNE` loads a pointer to the string «*something unknown* \n» into `R0`, since  $a$  has already been checked to be equal to 0 or 1, and we can sure that the  $a$  variable is not equal to these numbers at this point. And if  $R0 = 2$ , a pointer to the string «*two* \n» will be loaded by `ADREQ` into `R0`.

### ARM: Optimizing Keil 6/2013 (Thumb mode)

```
.text:000000D4          f1:
.text:000000D4 10 B5      PUSH    {R4,LR}
.text:000000D6 00 28      CMP     R0, #0
.text:000000D8 05 D0      BEQ     zero_case
.text:000000DA 01 28      CMP     R0, #1
.text:000000DC 05 D0      BEQ     one_case
.text:000000DE 02 28      CMP     R0, #2
.text:000000E0 05 D0      BEQ     two_case
.text:000000E2 91 A0      ADR     R0, aSomethingUnkno ; "something unknown\n"
.text:000000E4 04 E0      B       default_case

.text:000000E6          zero_case: ; CODE XREF: f1+4
.text:000000E6 95 A0      ADR     R0, aZero ; "zero\n"
.text:000000E8 02 E0      B       default_case

.text:000000EA          one_case: ; CODE XREF: f1+8
.text:000000EA 96 A0      ADR     R0, aOne ; "one\n"
.text:000000EC 00 E0      B       default_case

.text:000000EE          two_case: ; CODE XREF: f1+C
.text:000000EE 97 A0      ADR     R0, aTwo ; "two\n"
.text:000000F0          default_case ; CODE XREF: f1+10
.text:000000F0          ; f1+14
.text:000000F0 06 F0 7E F8  BL     __2printf
.text:000000F4 10 BD      POP     {R4,PC}
```

As was already mentioned, it is not possible to add conditional predicates to most instructions in Thumb mode, so the Thumb-code here is somewhat similar to the easily understandable x86 [CISC](#)-style code.

### ARM64: Non-optimizing GCC (Linaro) 4.9

```
.LC12:
.string "zero"
.LC13:
.string "one"
.LC14:
.string "two"
.LC15:
.string "something unknown"
f12:
    stp    x29, x30, [sp, -32]!
    add    x29, sp, 0
    str    w0, [x29,28]
    ldr    w0, [x29,28]
    cmp    w0, 1
    beq    .L34
    cmp    w0, 2
    beq    .L35
    cmp    w0, wzr
    bne    .L38          ; jump to default label
    adrp   x0, .LC12     ; "zero"
    add    x0, x0, :lo12:.LC12
    bl     puts
    b     .L32
.L34:
    adrp   x0, .LC13     ; "one"
    add    x0, x0, :lo12:.LC13
    bl     puts
    b     .L32
.L35:
    adrp   x0, .LC14     ; "two"
```

```

        add    x0, x0, :lo12:LC14
        bl    puts
        b     .L32
.L38:
        adrp   x0, .LC15      ; "something unknown"
        add    x0, x0, :lo12:LC15
        bl    puts
        nop
.L32:
        ldp   x29, x30, [sp], 32
        ret

```

The type of the input value is *int*, hence register *W0* is used to hold it instead of the whole *X0* register.

The string pointers are passed to `puts()` using an `ADRP/ADD` instructions pair just like it was demonstrated in the “Hello, world!” example: [1.5.3 on page 23](#).

## ARM64: Optimizing GCC (Linaro) 4.9

```

f12:
        cmp    w0, 1
        beq    .L31
        cmp    w0, 2
        beq    .L32
        cbz    w0, .L35
; default case
        adrp   x0, .LC15      ; "something unknown"
        add    x0, x0, :lo12:LC15
        b     puts
.L35:
        adrp   x0, .LC12      ; "zero"
        add    x0, x0, :lo12:LC12
        b     puts
.L32:
        adrp   x0, .LC14      ; "two"
        add    x0, x0, :lo12:LC14
        b     puts
.L31:
        adrp   x0, .LC13      ; "one"
        add    x0, x0, :lo12:LC13
        b     puts

```

Better optimized piece of code. *CBZ* (*Compare and Branch on Zero*) instruction does jump if *W0* is zero. There is also a direct jump to `puts()` instead of calling it, like it was explained before: [1.21.1 on page 156](#).

## MIPS

Listing 1.157: Optimizing GCC 4.4.5 (IDA)

```

f:
        lui    $gp, (__gnu_local_gp >> 16)
; is it 1?
        li    $v0, 1
        beq   $a0, $v0, loc_60
        la    $gp, (__gnu_local_gp & 0xFFFF) ; branch delay slot
; is it 2?
        li    $v0, 2
        beq   $a0, $v0, loc_4C
        or    $at, $zero ; branch delay slot, NOP
; jump, if not equal to 0:
        bnez  $a0, loc_38
        or    $at, $zero ; branch delay slot, NOP
; zero case:
        lui   $a0, ($LC0 >> 16) # "zero"
        lw    $t9, (puts & 0xFFFF)($gp)
        or    $at, $zero ; load delay slot, NOP
        jr   $t9 ; branch delay slot, NOP
        la    $a0, ($LC0 & 0xFFFF) # "zero" ; branch delay slot

```



```

loc_38:                                # CODE XREF: f+1C
    lui    $a0, ($LC3 >> 16) # "something unknown"
    lw     $t9, (puts & 0xFFFF)($gp)
    or     $at, $zero ; load delay slot, NOP
    jr     $t9
    la     $a0, ($LC3 & 0xFFFF) # "something unknown" ; branch delay slot

loc_4C:                                # CODE XREF: f+14
    lui    $a0, ($LC2 >> 16) # "two"
    lw     $t9, (puts & 0xFFFF)($gp)
    or     $at, $zero ; load delay slot, NOP
    jr     $t9
    la     $a0, ($LC2 & 0xFFFF) # "two" ; branch delay slot

loc_60:                                # CODE XREF: f+8
    lui    $a0, ($LC1 >> 16) # "one"
    lw     $t9, (puts & 0xFFFF)($gp)
    or     $at, $zero ; load delay slot, NOP
    jr     $t9
    la     $a0, ($LC1 & 0xFFFF) # "one" ; branch delay slot

```

The function always ends with calling `puts()`, so here we see a jump to `puts()` (JR: “Jump Register”) instead of “jump and link”. We talked about this earlier: [1.21.1 on page 156](#).

We also often see NOP instructions after LW ones. This is “load delay slot”: another *delay slot* in MIPS.

An instruction next to LW may execute at the moment while LW loads value from memory.

However, the next instruction must not use the result of LW.

Modern MIPS CPUs have a feature to wait if the next instruction uses result of LW, so this is somewhat outdated, but GCC still adds NOPs for older MIPS CPUs. In general, it can be ignored.

## Conclusion

A `switch()` with few cases is indistinguishable from an `if/else` construction, for example: [listing.1.21.1](#).

### 1.21.2 A lot of cases

If a `switch()` statement contains a lot of cases, it is not very convenient for the compiler to emit too large code with a lot JE/JNE instructions.

```

#include <stdio.h>

void f (int a)
{
    switch (a)
    {
        case 0: printf ("zero\n"); break;
        case 1: printf ("one\n"); break;
        case 2: printf ("two\n"); break;
        case 3: printf ("three\n"); break;
        case 4: printf ("four\n"); break;
        default: printf ("something unknown\n"); break;
    };
};

int main()
{
    f (2); // test
};

```

## x86

### Non-optimizing MSVC

We get (MSVC 2010):

Listing 1.158: MSVC 2010

```

tv64 = -4 ; size = 4
_a$ = 8 ; size = 4
_f PROC
    push    ebp
    mov     ebp, esp
    push    ecx
    mov     eax, DWORD PTR _a$[ebp]
    mov     DWORD PTR tv64[ebp], eax
    cmp     DWORD PTR tv64[ebp], 4
    ja     SHORT $LN1@f
    mov     ecx, DWORD PTR tv64[ebp]
    jmp     DWORD PTR $LN11@f[ecx*4]
$LN6@f:
    push    OFFSET $SG739 ; 'zero', 0aH, 00H
    call    _printf
    add     esp, 4
    jmp     SHORT $LN9@f
$LN5@f:
    push    OFFSET $SG741 ; 'one', 0aH, 00H
    call    _printf
    add     esp, 4
    jmp     SHORT $LN9@f
$LN4@f:
    push    OFFSET $SG743 ; 'two', 0aH, 00H
    call    _printf
    add     esp, 4
    jmp     SHORT $LN9@f
$LN3@f:
    push    OFFSET $SG745 ; 'three', 0aH, 00H
    call    _printf
    add     esp, 4
    jmp     SHORT $LN9@f
$LN2@f:
    push    OFFSET $SG747 ; 'four', 0aH, 00H
    call    _printf
    add     esp, 4
    jmp     SHORT $LN9@f
$LN1@f:
    push    OFFSET $SG749 ; 'something unknown', 0aH, 00H
    call    _printf
    add     esp, 4
$LN9@f:
    mov     esp, ebp
    pop     ebp
    ret     0
    npad   2 ; align next label
$LN11@f:
    DD     $LN6@f ; 0
    DD     $LN5@f ; 1
    DD     $LN4@f ; 2
    DD     $LN3@f ; 3
    DD     $LN2@f ; 4
_f ENDP

```

What we see here is a set of `printf()` calls with various arguments. All they have not only addresses in the memory of the process, but also internal symbolic labels assigned by the compiler. All these labels are also mentioned in the `$LN11@f` internal table.

At the function start, if `a` is greater than 4, control flow is passed to label `$LN1@f`, where `printf()` with argument 'something unknown' is called.

But if the value of `a` is less or equals to 4, then it gets multiplied by 4 and added with the `$LN11@f` table address. That is how an address inside the table is constructed, pointing exactly to the element we need. For example, let's say `a` is equal to 2.  $2 * 4 = 8$  (all table elements are addresses in a 32-bit process and that is why all elements are 4 bytes wide). The address of the `$LN11@f` table + 8 is the table element where the `$LN4@f` label is stored. `JMP` fetches the `$LN4@f` address from the table and jumps to it.

This table is sometimes called *jumptable* or *branch table*<sup>94</sup>.

Then the corresponding `printf()` is called with argument 'two'.

Literally, the `jmp DWORD PTR $LN11@f[ecx*4]` instruction implies *jump to the DWORD that is stored at address  $\$LN11@f + ecx * 4$ .*

`npad` ([.1.7 on page 1039](#)) is an assembly language macro that align the next label so that it will be stored at an address aligned on a 4 bytes (or 16 bytes) boundary. This is very suitable for the processor since it is able to fetch 32-bit values from memory through the memory bus, cache memory, etc., in a more effective way if it is aligned.

---

<sup>94</sup>The whole method was once called *computed GOTO* in early versions of Fortran: [wikipedia](#). Not quite relevant these days, but what a term!

# OllyDbg

Let's try this example in OllyDbg. The input value of the function (2) is loaded into EAX:

The screenshot shows the CPU window for the main thread in module lot. The assembly code at address 010B1007 is highlighted, showing the instruction `MOV DWORD PTR SS:[EBP-4],EAX`. The registers window shows EAX containing 00000002. The stack window shows the current stack frame for MSUCR100. The memory dump window shows the ASCII representation of the stack data, including the string "one two three four something unknown".

Address	Hex dump	ASCII (ANSI - Cy)	Registers (MMX)	Stack	Memory Dump
010B1000	55	PUSH EBP	EAX 00000002	EAX=2	010B3000
010B1001	8BEC	MOV EBP,ESP	EAX 00000002	Stack [003CFDA8]=6E494714 (MSUCR100.__initenv)	010B3010
010B1003	51	PUSH ECX	EAX 00000002		010B3020
010B1004	8B45 08	MOV EAX,DWORD PTR SS:[EBP+8]	EAX 00000002		010B3030
010B1007	8945 FC	MOV DWORD PTR SS:[EBP-4],EAX	EAX 00000002		010B3040
010B100A	837D FC 04	CMP DWORD PTR SS:[EBP-4],4	EAX 00000002		010B3050
010B100E	77 5A	JA SHORT 010B106A	EAX 00000002		010B3060
010B1010	8B4D FC	MOV ECX,DWORD PTR SS:[EBP-4]	EAX 00000002		010B3070
010B1013	FF248D 7C100	JMP DWORD PTR DS:[ECX*4+10B107C]	EAX 00000002		010B3080
010B101A	68 00300001	PUSH OFFSET 010B3000	EAX 00000002		010B3090
010B101F	FF15 00200000	CALL DWORD PTR DS:[<&MSUCR100.printf>]	EAX 00000002		010B30A0
010B1025	83C4 04	ADD ESP,4	EAX 00000002		010B30B0
010B1028	EB 4E	JMP SHORT 010B1078	EAX 00000002		010B30C0
010B102A	68 00300001	PUSH OFFSET 010B3000	EAX 00000002		010B30D0
010B102F	FF15 00200000	CALL DWORD PTR DS:[<&MSUCR100.printf>]	EAX 00000002		010B30E0
010B1035	83C4 04	ADD ESP,4	EAX 00000002		010B30F0
010B1038	EB 3E	JMP SHORT 010B1078	EAX 00000002		010B3100
010B103A	68 10300001	PUSH OFFSET 010B3010	EAX 00000002		010B3110
010B103F	FF15 00200000	CALL DWORD PTR DS:[<&MSUCR100.printf>]	EAX 00000002		010B3120
010B1045	83C4 04	ADD ESP,4	EAX 00000002		010B3130
010B1048	EB 2E	JMP SHORT 010B1078	EAX 00000002		010B3140

Figure 1.51: OllyDbg: function's input value is loaded in EAX

The input value is checked, is it bigger than 4? If not, the “default” jump is not taken:

**CPU - main thread, module lot**

Address	Hex	Disassembly	Comments
010B1000	55	PUSH EBP	
010B1001	8BEC	MOV EBP,ESP	
010B1003	51	PUSH ECX	
010B1004	8B45 08	MOV EAX,DWORD PTR SS:[EBP+8]	
010B1007	8945 FC	MOV DWORD PTR SS:[EBP-4],EAX	
010B100A	837D FC 04	CMP DWORD PTR SS:[EBP-4],4	
010B100E	77 5A	JA SHORT 010B106A	
010B1010	8B4D FC	MOV ECX,DWORD PTR SS:[EBP-4]	
010B1013	FF248D 7C100	JMP DWORD PTR DS:[ECX*4+010B107C]	
010B101A	68 00300B01	PUSH OFFSET 010B3000	
010B101F	FF15 00200B00	CALL DWORD PTR DS:[&MSUCR100.printf]	format = MSUCR100.
010B1025	83C4 04	ADD ESP,4	
010B1028	EB 4E	JMP SHORT 010B1078	
010B102A	68 00300B01	PUSH OFFSET 010B3008	
010B102F	FF15 00200B00	CALL DWORD PTR DS:[&MSUCR100.printf]	format = MSUCR100.
010B1035	83C4 04	ADD ESP,4	
010B1038	EB 3E	JMP SHORT 010B1078	
010B103A	68 10300B01	PUSH OFFSET 010B3010	
010B103F	FF15 00200B00	CALL DWORD PTR DS:[&MSUCR100.printf]	format = MSUCR100.
010B1045	83C4 04	ADD ESP,4	
010B1048	EB 2E	JMP SHORT 010B1078	

**Registers (MMX)**

EAX	00000002
ECX	6E494714 MSUCR100.__initenv
EDX	00000000
EBX	00000000
ESP	003CFD88
EBP	003CFD8C
ESI	00000001
EDI	010B33B8 lot.010B33B8
EIP	010B100E lot.010B100E
C 1	ES 002B 32bit 0(FFFFFFFF)
P 0	CS 0023 32bit 0(FFFFFFFF)
A 1	SS 002B 32bit 0(FFFFFFFF)
Z 0	DS 002B 32bit 0(FFFFFFFF)
S 1	FS 0053 32bit 7EFDD000(FFF)
T 0	GS 002B 32bit 0(FFFFFFFF)
D 0	
O 0	LastErr 00000000 ERROR_SUCCESS
EFL	00000293 (NO,B,NE,BE,S,PO,L,LE)
MM0	0000 0000 0000 0000
MM1	0000 0000 0000 0000
MM2	0000 0000 0000 0000
MM3	0000 0000 0000 0000
MM4	0000 0000 0000 0000

**Jump is not taken  
Dest=lot.010B106A**

Address	Hex dump	ASCII (ANSI - Cy)
010B3000	7A 65 72 6F 0A 00 00 00 00 6F 6E 65 0A 00 00 00 00	zero one
010B3010	74 77 6F 0A 00 00 00 00 74 68 72 65 65 0A 00 00	two three
010B3020	66 6F 75 72 0A 00 00 00 73 6F 6D 65 74 68 69 6E	four somethin
010B3030	67 20 75 6E 6B 6E 6F 77 6E 0A 00 00 FF FF FF FF	g unknown
010B3040	FF FF FF FF 00 00 00 00 00 00 00 00 00 00 00 00	
010B3050	FE FF FF FF 01 00 00 00 9A E2 68 1D 65 1D 97 E2	H h
010B3060	01 00 00 00 48 28 03 00 68 4E 03 00 00 00 00 00	
010B3070	00 00 00 00 00 00 00 00 00 00 00 00 00 00 00 00	
010B3080	00 00 00 00 00 00 00 00 00 00 00 00 00 00 00 00	
010B3090	00 00 00 00 00 00 00 00 00 00 00 00 00 00 00 00	
010B30A0	00 00 00 00 00 00 00 00 00 00 00 00 00 00 00 00	
010B30B0	00 00 00 00 00 00 00 00 00 00 00 00 00 00 00 00	
010B30C0	00 00 00 00 00 00 00 00 00 00 00 00 00 00 00 00	

**003CFD88 00000002**

**003CFD8C 003CFD88** RETURN from

**003CFD90 010B109A** RETURN from

**003CFD94 00000002**

**003CFD98 003CFDFC** RETURN from

**003CFD9C 010B120E**

**003CFDA0 00000001**

**003CFDA4 00034E68** hN

**003CFDA8 00032848** H

**003CFDAC 1D541F66** fT

**003CFDAE 00000000**

**003CFDB0 00000000**

**003CFDB4 00000000**

**003CFDB8 7EFDE000** p

**003CFDBC 00000000**

Figure 1.52: OllyDbg: 2 is no bigger than 4: no jump is taken

Here we see a jumtable:

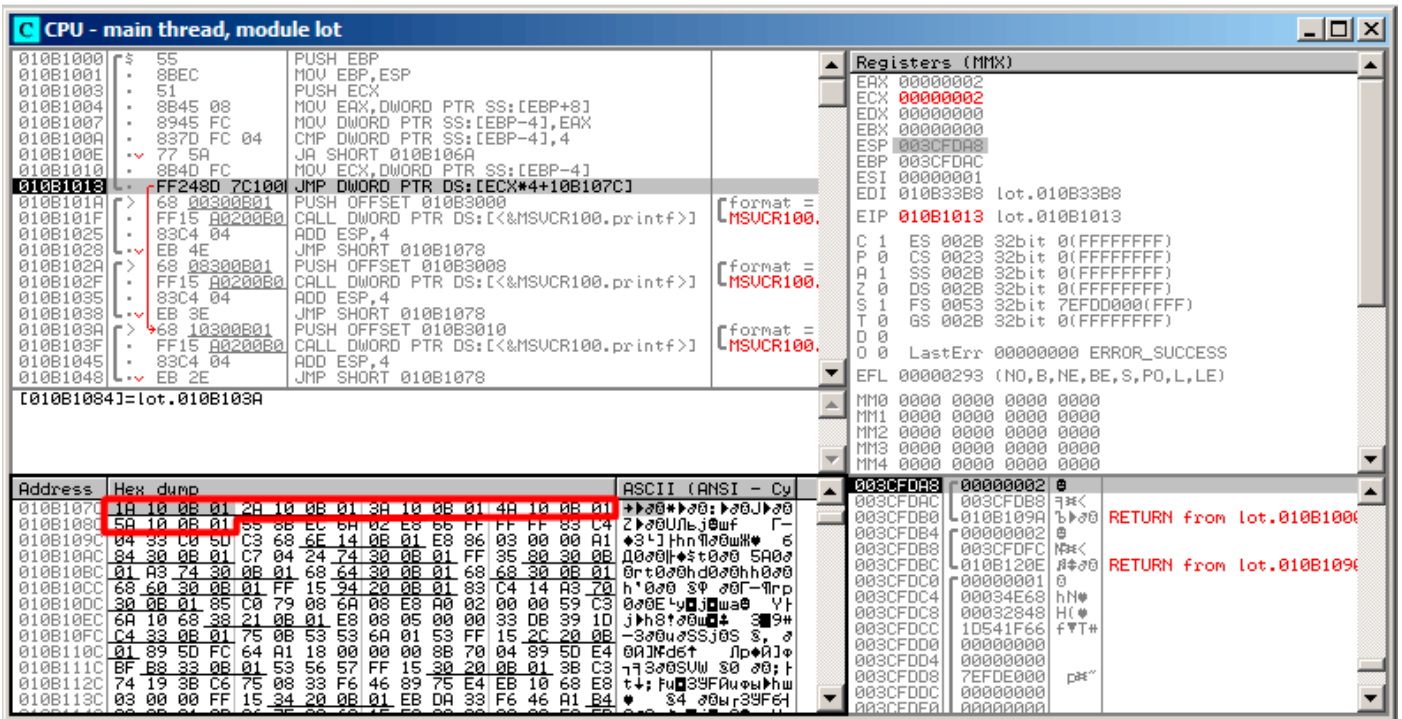

Figure 1.53: OllyDbg: calculating destination address using jumtable

Here we've clicked "Follow in Dump" → "Address constant", so now we see the *jumtable* in the data window. These are 5 32-bit values<sup>95</sup>. ECX is now 2, so the third element (can be indexed as 2<sup>96</sup>) of the table is to be used. It's also possible to click "Follow in Dump" → "Memory address" and OllyDbg will show the element addressed by the JMP instruction. That's 0x010B103A.

<sup>95</sup>They are underlined by OllyDbg because these are also FIXUPS: 6.5.2 on page 761, we are going to come back to them later

<sup>96</sup>About indexing, see also: 3.22.3 on page 598

After the jump we are at 0x010B103A: the code printing "two" will now be executed:

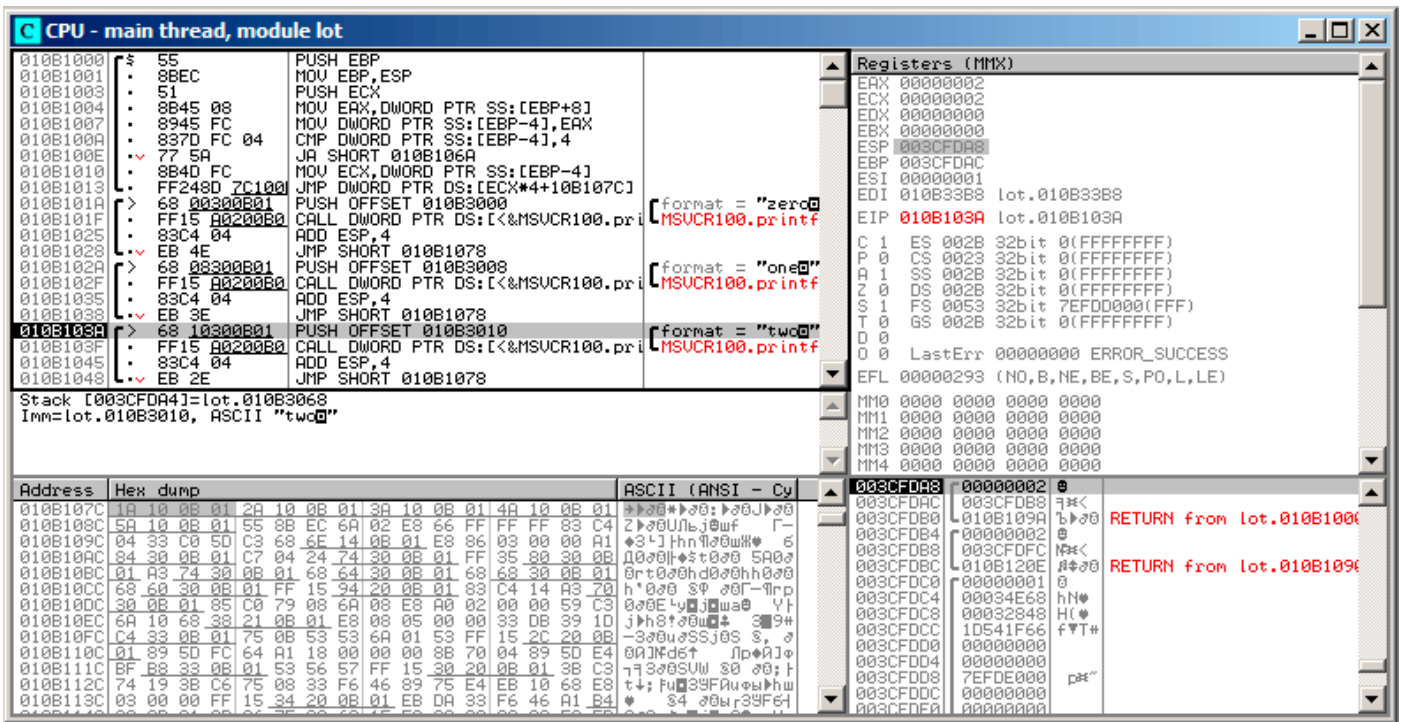

Figure 1.54: OllyDbg: now we at the case: label

## Non-optimizing GCC

Let's see what GCC 4.4.1 generates:

Listing 1.159: GCC 4.4.1

```

public f
f
proc near ; CODE XREF: main+10

var_18 = dword ptr -18h
arg_0 = dword ptr 8

push    ebp
mov     ebp, esp
sub     esp, 18h
cmp     [ebp+arg_0], 4
ja     short loc_8048444
mov     eax, [ebp+arg_0]
shl    eax, 2
mov     eax, ds:off_804855C[eax]
jmp     eax

loc_80483FE: ; DATA XREF: .rodata:off_804855C
mov     [esp+18h+var_18], offset aZero ; "zero"
call    _puts
jmp     short locret_8048450

loc_804840C: ; DATA XREF: .rodata:08048560
mov     [esp+18h+var_18], offset aOne ; "one"
call    _puts
jmp     short locret_8048450

loc_804841A: ; DATA XREF: .rodata:08048564
mov     [esp+18h+var_18], offset aTwo ; "two"
call    _puts
jmp     short locret_8048450

loc_8048428: ; DATA XREF: .rodata:08048568
    
```

```

    mov    [esp+18h+var_18], offset aThree ; "three"
    call  _puts
    jmp   short locret_8048450

loc_8048436: ; DATA XREF: .rodata:0804856C
    mov    [esp+18h+var_18], offset aFour ; "four"
    call  _puts
    jmp   short locret_8048450

loc_8048444: ; CODE XREF: f+A
    mov    [esp+18h+var_18], offset aSomethingUnkno ; "something unknown"
    call  _puts

locret_8048450: ; CODE XREF: f+26
                ; f+34...
    leave
    retn
f               endp

off_804855C dd offset loc_80483FE ; DATA XREF: f+12
            dd offset loc_804840C
            dd offset loc_804841A
            dd offset loc_8048428
            dd offset loc_8048436

```

It is almost the same, with a little nuance: argument `arg_0` is multiplied by 4 by shifting it to left by 2 bits (it is almost the same as multiplication by 4) ([1.24.2 on page 217](#)). Then the address of the label is taken from the `off_804855C` array, stored in `EAX`, and then `JMP EAX` does the actual jump.

## ARM: Optimizing Keil 6/2013 (ARM mode)

Listing 1.160: Optimizing Keil 6/2013 (ARM mode)

```

00000174          f2
00000174 05 00 50 E3      CMP     R0, #5           ; switch 5 cases
00000178 00 F1 8F 30      ADDCC  PC, PC, R0,LSL#2 ; switch jump
0000017C 0E 00 00 EA      B      default_case    ; jumtable 00000178 default case

00000180
00000180          loc_180 ; CODE XREF: f2+4
00000180 03 00 00 EA      B      zero_case       ; jumtable 00000178 case 0

00000184
00000184          loc_184 ; CODE XREF: f2+4
00000184 04 00 00 EA      B      one_case        ; jumtable 00000178 case 1

00000188
00000188          loc_188 ; CODE XREF: f2+4
00000188 05 00 00 EA      B      two_case        ; jumtable 00000178 case 2

0000018C
0000018C          loc_18C ; CODE XREF: f2+4
0000018C 06 00 00 EA      B      three_case     ; jumtable 00000178 case 3

00000190
00000190          loc_190 ; CODE XREF: f2+4
00000190 07 00 00 EA      B      four_case      ; jumtable 00000178 case 4

00000194
00000194          zero_case ; CODE XREF: f2+4
00000194          ; f2:loc_180
00000194 EC 00 8F E2      ADR    R0, aZero       ; jumtable 00000178 case 0
00000198 06 00 00 EA      B      loc_1B8

0000019C
0000019C          one_case ; CODE XREF: f2+4
0000019C          ; f2:loc_184
0000019C EC 00 8F E2      ADR    R0, aOne        ; jumtable 00000178 case 1
000001A0 04 00 00 EA      B      loc_1B8

```



```

000001A4
000001A4          two_case ; CODE XREF: f2+4
000001A4          ; f2:loc_188
000001A4 01 0C 8F E2    ADR    R0, aTwo          ; jumtable 00000178 case 2
000001A8 02 00 00 EA    B      loc_1B8

000001AC
000001AC          three_case ; CODE XREF: f2+4
000001AC          ; f2:loc_18C
000001AC 01 0C 8F E2    ADR    R0, aThree       ; jumtable 00000178 case 3
000001B0 00 00 00 EA    B      loc_1B8

000001B4
000001B4          four_case ; CODE XREF: f2+4
000001B4          ; f2:loc_190
000001B4 01 0C 8F E2    ADR    R0, aFour        ; jumtable 00000178 case 4
000001B8
000001B8          loc_1B8 ; CODE XREF: f2+24
000001B8          ; f2+2C
000001B8 66 18 00 EA    B      __2printf

000001BC
000001BC          default_case ; CODE XREF: f2+4
000001BC          ; f2+8
000001BC D4 00 8F E2    ADR    R0, aSomethingUnkno ; jumtable 00000178 default case
000001C0 FC FF FF EA    B      loc_1B8

```

This code makes use of the ARM mode feature in which all instructions have a fixed size of 4 bytes.

Let's keep in mind that the maximum value for *a* is 4 and any greater value will cause «*something unknown*\n» string to be printed.

The first `CMP R0, #5` instruction compares the input value of *a* with 5.

<sup>97</sup> The next `ADDCC PC, PC, R0, LSL#2` instruction is being executed only if  $R0 < 5$  (*CC=Carry clear / Less than*). Consequently, if `ADDCC` does not trigger (it is a  $R0 \geq 5$  case), a jump to `default_case` label will occur.

But if  $R0 < 5$  and `ADDCC` triggers, the following is to be happen:

The value in `R0` is multiplied by 4. In fact, `LSL#2` at the instruction's suffix stands for "shift left by 2 bits". But as we will see later ( [1.24.2 on page 217](#) ) in section "Shifts", shift left by 2 bits is equivalent to multiplying by 4.

Then we add  $R0 * 4$  to the current value in `PC`, thus jumping to one of the `B (Branch)` instructions located below.

At the moment of the execution of `ADDCC`, the value in `PC` is 8 bytes ahead (`0x180`) than the address at which the `ADDCC` instruction is located (`0x178`), or, in other words, 2 instructions ahead.

This is how the pipeline in ARM processors works: when `ADDCC` is executed, the processor at the moment is beginning to process the instruction after the next one, so that is why `PC` points there. This has to be memorized.

If  $a = 0$ , then is to be added to the value in `PC`, and the actual value of the `PC` will be written into `PC` (which is 8 bytes ahead) and a jump to the label `loc_180` will happen, which is 8 bytes ahead of the point where the `ADDCC` instruction is.

If  $a = 1$ , then  $PC + 8 + a * 4 = PC + 8 + 1 * 4 = PC + 12 = 0x184$  will be written to `PC`, which is the address of the `loc_184` label.

With every 1 added to *a*, the resulting `PC` is increased by 4.

4 is the instruction length in ARM mode and also, the length of each `B` instruction, of which there are 5 in row.

Each of these five `B` instructions passes control further, to what was programmed in the `switch()`.

Pointer loading of the corresponding string occurs there, etc.

<sup>97</sup>ADD—addition

## ARM: Optimizing Keil 6/2013 (Thumb mode)

Listing 1.161: Optimizing Keil 6/2013 (Thumb mode)

```
000000F6          EXPORT f2
000000F6          f2
000000F6 10 B5          PUSH    {R4,LR}
000000F8 03 00          MOVS   R3, R0
000000FA 06 F0 69 F8      BL     __ARM_common_switch8_thumb ; switch 6 cases

000000FE 05          DCB 5
000000FF 04 06 08 0A 0C 10  DCB 4, 6, 8, 0xA, 0xC, 0x10 ; jump table for switch statement
00000105 00          ALIGN 2
00000106          zero_case ; CODE XREF: f2+4
00000106 8D A0          ADR    R0, aZero ; jumtable 000000FA case 0
00000108 06 E0          B     loc_118

0000010A          one_case ; CODE XREF: f2+4
0000010A 8E A0          ADR    R0, aOne ; jumtable 000000FA case 1
0000010C 04 E0          B     loc_118

0000010E          two_case ; CODE XREF: f2+4
0000010E 8F A0          ADR    R0, aTwo ; jumtable 000000FA case 2
00000110 02 E0          B     loc_118

00000112          three_case ; CODE XREF: f2+4
00000112 90 A0          ADR    R0, aThree ; jumtable 000000FA case 3
00000114 00 E0          B     loc_118

00000116          four_case ; CODE XREF: f2+4
00000116 91 A0          ADR    R0, aFour ; jumtable 000000FA case 4
00000118          loc_118 ; CODE XREF: f2+12
00000118          ; f2+16
00000118 06 F0 6A F8      BL     __2printf
0000011C 10 BD          POP    {R4,PC}

0000011E          default_case ; CODE XREF: f2+4
0000011E 82 A0          ADR    R0, aSomethingUnkno ; jumtable 000000FA default case
00000120 FA E7          B     loc_118

000061D0          EXPORT __ARM_common_switch8_thumb
000061D0          __ARM_common_switch8_thumb ; CODE XREF: example6_f2+4
000061D0 78 47          BX     PC

000061D2 00 00          ALIGN 4
000061D2          ; End of function __ARM_common_switch8_thumb
000061D2
000061D4          __32__ARM_common_switch8_thumb ; CODE XREF:
000061D4          ARM_common_switch8_thumb
000061D4 01 C0 5E E5      LDRB   R12, [LR,#-1]
000061D8 0C 00 53 E1      CMP    R3, R12
000061DC 0C 30 DE 27      LDRCSB R3, [LR,R12]
000061E0 03 30 DE 37      LDRCCB R3, [LR,R3]
000061E4 83 C0 8E E0      ADD    R12, LR, R3,LSL#1
000061E8 1C FF 2F E1      BX     R12
000061E8          ; End of function __32__ARM_common_switch8_thumb
```

One cannot be sure that all instructions in Thumb and Thumb-2 modes has the same size. It can even be said that in these modes the instructions have variable lengths, just like in x86.

So there is a special table added that contains information about how much cases are there (not including default-case), and an offset for each with a label to which control must be passed in the corresponding case.

A special function is present here in order to deal with the table and pass control, named `__ARM_common_switch8_thumb`. It starts with `BX PC`, whose function is to switch the processor to ARM-mode. Then you see the function for table processing.

It is too advanced to describe it here now, so let's omit it.

It is interesting to note that the function uses the `LR` register as a pointer to the table.

Indeed, after calling of this function, `LR` contains the address after `BL __ARM_common_switch8_thumb` instruction, where the table starts.

It is also worth noting that the code is generated as a separate function in order to reuse it, so the compiler doesn't generate the same code for every `switch()` statement.

`IDA` successfully perceived it as a service function and a table, and added comments to the labels like `jumptable 000000FA case 0`.

## MIPS

Listing 1.162: Optimizing GCC 4.4.5 (IDA)

```
f:
    lui    $gp, (__gnu_local_gp >> 16)
; jump to loc_24 if input value is lesser than 5:
    sltiu $v0, $a0, 5
    bnez  $v0, loc_24
    la    $gp, (__gnu_local_gp & 0xFFFF) ; branch delay slot
; input value is greater or equal to 5.
; print "something unknown" and finish:
    lui   $a0, ($LC5 >> 16) # "something unknown"
    lw    $t9, (puts & 0xFFFF)($gp)
    or    $at, $zero ; NOP
    jr    $t9
    la    $a0, ($LC5 & 0xFFFF) # "something unknown" ; branch delay slot

loc_24:
                                # CODE XREF: f+8
; load address of jumptable
; LA is pseudoinstruction, LUI and ADDIU pair are there in fact:
    la    $v0, off_120
; multiply input value by 4:
    sll   $a0, 2
; sum up multiplied value and jumptable address:
    addu  $a0, $v0, $a0
; load element from jumptable:
    lw    $v0, 0($a0)
    or    $at, $zero ; NOP
; jump to the address we got in jumptable:
    jr    $v0
    or    $at, $zero ; branch delay slot, NOP

sub_44:
                                # DATA XREF: .rodata:0000012C
; print "three" and finish
    lui   $a0, ($LC3 >> 16) # "three"
    lw    $t9, (puts & 0xFFFF)($gp)
    or    $at, $zero ; NOP
    jr    $t9
    la    $a0, ($LC3 & 0xFFFF) # "three" ; branch delay slot

sub_58:
                                # DATA XREF: .rodata:00000130
; print "four" and finish
    lui   $a0, ($LC4 >> 16) # "four"
    lw    $t9, (puts & 0xFFFF)($gp)
    or    $at, $zero ; NOP
    jr    $t9
    la    $a0, ($LC4 & 0xFFFF) # "four" ; branch delay slot

sub_6C:
                                # DATA XREF: .rodata:off_120
; print "zero" and finish
    lui   $a0, ($LC0 >> 16) # "zero"
    lw    $t9, (puts & 0xFFFF)($gp)
    or    $at, $zero ; NOP
```

```

        jr      $t9
        la      $a0, ($LC0 & 0xFFFF) # "zero" ; branch delay slot

sub_80:                                # DATA XREF: .rodata:00000124
; print "one" and finish
        lui    $a0, ($LC1 >> 16) # "one"
        lw     $t9, (puts & 0xFFFF)($gp)
        or     $at, $zero ; NOP
        jr     $t9
        la     $a0, ($LC1 & 0xFFFF) # "one" ; branch delay slot

sub_94:                                # DATA XREF: .rodata:00000128
; print "two" and finish
        lui    $a0, ($LC2 >> 16) # "two"
        lw     $t9, (puts & 0xFFFF)($gp)
        or     $at, $zero ; NOP
        jr     $t9
        la     $a0, ($LC2 & 0xFFFF) # "two" ; branch delay slot

; may be placed in .rodata section:
off_120: .word sub_6C
         .word sub_80
         .word sub_94
         .word sub_44
         .word sub_58

```

The new instruction for us is SLTIU (“Set on Less Than Immediate Unsigned”).

This is the same as SLTU (“Set on Less Than Unsigned”), but “I” stands for “immediate”, i.e., a number has to be specified in the instruction itself.

BNEZ is “Branch if Not Equal to Zero”.

Code is very close to the other ISAs. SLL (“Shift Word Left Logical”) does multiplication by 4.

MIPS is a 32-bit CPU after all, so all addresses in the *jump table* are 32-bit ones.

## Conclusion

Rough skeleton of *switch()*:

Listing 1.163: x86

```

MOV REG, input
CMP REG, 4 ; maximal number of cases
JA default
SHL REG, 2 ; find element in table. shift for 3 bits in x64.
MOV REG, jump_table[REG]
JMP REG

case1:
    ; do something
    JMP exit
case2:
    ; do something
    JMP exit
case3:
    ; do something
    JMP exit
case4:
    ; do something
    JMP exit
case5:
    ; do something
    JMP exit

default:
    ...

exit:

```

```

....
jump_table dd case1
           dd case2
           dd case3
           dd case4
           dd case5

```

The jump to the address in the jump table may also be implemented using this instruction: `JMP jump_table[REG*4]`. Or `JMP jump_table[REG*8]` in x64.

A *jump table* is just array of pointers, like the one described later: [1.26.5 on page 285](#).

### 1.21.3 When there are several case statements in one block

Here is a very widespread construction: several case statements for a single block:

```

#include <stdio.h>

void f(int a)
{
    switch (a)
    {
        case 1:
        case 2:
        case 7:
        case 10:
            printf ("1, 2, 7, 10\n");
            break;

        case 3:
        case 4:
        case 5:
        case 6:
            printf ("3, 4, 5\n");
            break;

        case 8:
        case 9:
        case 20:
        case 21:
            printf ("8, 9, 21\n");
            break;

        case 22:
            printf ("22\n");
            break;

        default:
            printf ("default\n");
            break;
    };
};

int main()
{
    f(4);
};

```

It's too wasteful to generate a block for each possible case, so what is usually done is to generate each block plus some kind of dispatcher.

#### MSVC

Listing 1.164: Optimizing MSVC 2010

```

1 $SG2798 DB      '1, 2, 7, 10', 0aH, 00H
2 $SG2800 DB      '3, 4, 5', 0aH, 00H
3 $SG2802 DB      '8, 9, 21', 0aH, 00H
4 $SG2804 DB      '22', 0aH, 00H
5 $SG2806 DB      'default', 0aH, 00H
6

```

```

7  _a$ = 8
8  _f      PROC
9          mov     eax, DWORD PTR _a$[esp-4]
10         dec     eax
11         cmp     eax, 21
12         ja      SHORT $LN1@f
13         movzx   eax, BYTE PTR $LN10@f[eax]
14         jmp     DWORD PTR $LN11@f[eax*4]
15 $LN5@f:
16         mov     DWORD PTR _a$[esp-4], OFFSET $SG2798 ; '1, 2, 7, 10'
17         jmp     DWORD PTR __imp__printf
18 $LN4@f:
19         mov     DWORD PTR _a$[esp-4], OFFSET $SG2800 ; '3, 4, 5'
20         jmp     DWORD PTR __imp__printf
21 $LN3@f:
22         mov     DWORD PTR _a$[esp-4], OFFSET $SG2802 ; '8, 9, 21'
23         jmp     DWORD PTR __imp__printf
24 $LN2@f:
25         mov     DWORD PTR _a$[esp-4], OFFSET $SG2804 ; '22'
26         jmp     DWORD PTR __imp__printf
27 $LN1@f:
28         mov     DWORD PTR _a$[esp-4], OFFSET $SG2806 ; 'default'
29         jmp     DWORD PTR __imp__printf
30         npad   2 ; align $LN11@f table on 16-byte boundary
31 $LN11@f:
32         DD     $LN5@f ; print '1, 2, 7, 10'
33         DD     $LN4@f ; print '3, 4, 5'
34         DD     $LN3@f ; print '8, 9, 21'
35         DD     $LN2@f ; print '22'
36         DD     $LN1@f ; print 'default'
37 $LN10@f:
38         DB     0 ; a=1
39         DB     0 ; a=2
40         DB     1 ; a=3
41         DB     1 ; a=4
42         DB     1 ; a=5
43         DB     1 ; a=6
44         DB     0 ; a=7
45         DB     2 ; a=8
46         DB     2 ; a=9
47         DB     0 ; a=10
48         DB     4 ; a=11
49         DB     4 ; a=12
50         DB     4 ; a=13
51         DB     4 ; a=14
52         DB     4 ; a=15
53         DB     4 ; a=16
54         DB     4 ; a=17
55         DB     4 ; a=18
56         DB     4 ; a=19
57         DB     2 ; a=20
58         DB     2 ; a=21
59         DB     3 ; a=22
60 _f      ENDP

```

We see two tables here: the first table (`$LN10@f`) is an index table, and the second one (`$LN11@f`) is an array of pointers to blocks.

First, the input value is used as an index in the index table (line 13).

Here is a short legend for the values in the table: 0 is the first case block (for values 1, 2, 7, 10), 1 is the second one (for values 3, 4, 5), 2 is the third one (for values 8, 9, 21), 3 is the fourth one (for value 22), 4 is for the default block.

There we get an index for the second table of code pointers and we jump to it (line 14).

What is also worth noting is that there is no case for input value 0.

That's why we see the DEC instruction at line 10, and the table starts at  $a = 1$ , because there is no need to allocate a table element for  $a = 0$ .

This is a very widespread pattern.

So why is this economical? Why isn't it possible to make it as before ( [1.21.2 on page 173](#)), just with one table consisting of block pointers? The reason is that the elements in index table are 8-bit, hence it's all more compact.

## GCC

GCC does the job in the way we already discussed ( [1.21.2 on page 173](#)), using just one table of pointers.

### ARM64: Optimizing GCC 4.9.1

There is no code to be triggered if the input value is 0, so GCC tries to make the jump table more compact and so it starts at 1 as an input value.

GCC 4.9.1 for ARM64 uses an even cleverer trick. It's able to encode all offsets as 8-bit bytes.

Let's recall that all ARM64 instructions have a size of 4 bytes.

GCC uses the fact that all offsets in my tiny example are in close proximity to each other. So the jump table consisting of single bytes.

Listing 1.165: Optimizing GCC 4.9.1 ARM64

```
f14:
; input value in W0
    sub    w0, w0, #1
    cmp    w0, 21
; branch if less or equal (unsigned):
    bls   .L9
.L2:
; print "default":
    adrp   x0, .LC4
    add    x0, x0, :lo12:.LC4
    b     puts
.L9:
; load jumptable address to X1:
    adrp   x1, .L4
    add    x1, x1, :lo12:.L4
; W0=input_value-1
; load byte from the table:
    ldrb   w0, [x1,w0,uxtw]
; load address of the Lrtx label:
    adr    x1, .Lrtx4
; multiply table element by 4 (by shifting 2 bits left) and add (or subtract) to the address of
; Lrtx:
    add    x0, x1, w0, sxtb #2
; jump to the calculated address:
    br     x0
; this label is pointing in code (text) segment:
.Lrtx4:
    .section      .rodata
; everything after ".section" statement is allocated in the read-only data (rodata) segment:
.L4:
    .byte   (.L3 - .Lrtx4) / 4    ; case 1
    .byte   (.L3 - .Lrtx4) / 4    ; case 2
    .byte   (.L5 - .Lrtx4) / 4    ; case 3
    .byte   (.L5 - .Lrtx4) / 4    ; case 4
    .byte   (.L5 - .Lrtx4) / 4    ; case 5
    .byte   (.L5 - .Lrtx4) / 4    ; case 6
    .byte   (.L3 - .Lrtx4) / 4    ; case 7
    .byte   (.L6 - .Lrtx4) / 4    ; case 8
    .byte   (.L6 - .Lrtx4) / 4    ; case 9
    .byte   (.L3 - .Lrtx4) / 4    ; case 10
    .byte   (.L2 - .Lrtx4) / 4    ; case 11
    .byte   (.L2 - .Lrtx4) / 4    ; case 12
    .byte   (.L2 - .Lrtx4) / 4    ; case 13
    .byte   (.L2 - .Lrtx4) / 4    ; case 14
    .byte   (.L2 - .Lrtx4) / 4    ; case 15
    .byte   (.L2 - .Lrtx4) / 4    ; case 16
    .byte   (.L2 - .Lrtx4) / 4    ; case 17
```

```

        .byte  (.L2 - .Lrtx4) / 4      ; case 18
        .byte  (.L2 - .Lrtx4) / 4      ; case 19
        .byte  (.L6 - .Lrtx4) / 4      ; case 20
        .byte  (.L6 - .Lrtx4) / 4      ; case 21
        .byte  (.L7 - .Lrtx4) / 4      ; case 22
        .text
; everything after ".text" statement is allocated in the code (text) segment:
.L7:
; print "22"
        adrp   x0, .LC3
        add    x0, x0, :lo12:LC3
        b      puts
.L6:
; print "8, 9, 21"
        adrp   x0, .LC2
        add    x0, x0, :lo12:LC2
        b      puts
.L5:
; print "3, 4, 5"
        adrp   x0, .LC1
        add    x0, x0, :lo12:LC1
        b      puts
.L3:
; print "1, 2, 7, 10"
        adrp   x0, .LC0
        add    x0, x0, :lo12:LC0
        b      puts
.LC0:
        .string "1, 2, 7, 10"
.LC1:
        .string "3, 4, 5"
.LC2:
        .string "8, 9, 21"
.LC3:
        .string "22"
.LC4:
        .string "default"

```

Let's compile this example to object file and open it in [IDA](#). Here is the jump table:

Listing 1.166: jumptable in IDA

```

.rodata:0000000000000064      AREA .rodata, DATA, READONLY
.rodata:0000000000000064      ; ORG 0x64
.rodata:0000000000000064 $d   DCB    9      ; case 1
.rodata:0000000000000065      DCB    9      ; case 2
.rodata:0000000000000066      DCB    6      ; case 3
.rodata:0000000000000067      DCB    6      ; case 4
.rodata:0000000000000068      DCB    6      ; case 5
.rodata:0000000000000069      DCB    6      ; case 6
.rodata:000000000000006A      DCB    9      ; case 7
.rodata:000000000000006B      DCB    3      ; case 8
.rodata:000000000000006C      DCB    3      ; case 9
.rodata:000000000000006D      DCB    9      ; case 10
.rodata:000000000000006E      DCB  0xF7    ; case 11
.rodata:000000000000006F      DCB  0xF7    ; case 12
.rodata:0000000000000070      DCB  0xF7    ; case 13
.rodata:0000000000000071      DCB  0xF7    ; case 14
.rodata:0000000000000072      DCB  0xF7    ; case 15
.rodata:0000000000000073      DCB  0xF7    ; case 16
.rodata:0000000000000074      DCB  0xF7    ; case 17
.rodata:0000000000000075      DCB  0xF7    ; case 18
.rodata:0000000000000076      DCB  0xF7    ; case 19
.rodata:0000000000000077      DCB    3      ; case 20
.rodata:0000000000000078      DCB    3      ; case 21
.rodata:0000000000000079      DCB    0      ; case 22
.rodata:000000000000007B      ; .rodata ends

```

So in case of 1, 9 is to be multiplied by 4 and added to the address of Lrtx4 label.

In case of 22, 0 is to be multiplied by 4, resulting in 0.



Right after the Lrtx4 label is the L7 label, where you can find the code that prints “22”.

There is no jump table in the code segment, it’s allocated in a separate .rodata section (there is no special necessity to place it in the code section).

There are also negative bytes (0xF7), they are used for jumping back to the code that prints the “default” string (at .L2).

### 1.21.4 Fall-through

Another popular usage of switch() operator is so-called “fallthrough”. Here is simple example<sup>98</sup>:

```
1 bool is_whitespace(char c) {
2     switch (c) {
3         case ' ': // fallthrough
4         case '\t': // fallthrough
5         case '\r': // fallthrough
6         case '\n':
7             return true;
8         default: // not whitespace
9             return false;
10    }
11 }
```

Slightly harder, from Linux kernel<sup>99</sup>:

```
1 char nco1, nco2;
2
3 void f(int if_freq_khz)
4 {
5
6     switch (if_freq_khz) {
7         default:
8             printf("IF=%d KHz is not supported, 3250 assumed\n", if_freq_khz);
9             /* fallthrough */
10        case 3250: /* 3.25Mhz */
11            nco1 = 0x34;
12            nco2 = 0x00;
13            break;
14        case 3500: /* 3.50Mhz */
15            nco1 = 0x38;
16            nco2 = 0x00;
17            break;
18        case 4000: /* 4.00Mhz */
19            nco1 = 0x40;
20            nco2 = 0x00;
21            break;
22        case 5000: /* 5.00Mhz */
23            nco1 = 0x50;
24            nco2 = 0x00;
25            break;
26        case 5380: /* 5.38Mhz */
27            nco1 = 0x56;
28            nco2 = 0x14;
29            break;
30    }
31 };
```

Listing 1.167: Optimizing GCC 5.4.0 x86

```
1 .LC0:
2     .string "IF=%d KHz is not supported, 3250 assumed\n"
3 f:
4     sub    esp, 12
5     mov    eax, DWORD PTR [esp+16]
6     cmp    eax, 4000
7     je     .L3
```

<sup>98</sup> Copypasted from [https://github.com/azonalon/prgraas/blob/master/proglib/lecture\\_examples/is\\_whitespace.c](https://github.com/azonalon/prgraas/blob/master/proglib/lecture_examples/is_whitespace.c)

<sup>99</sup> Copypasted from <https://github.com/torvalds/linux/blob/master/drivers/media/dvb-frontends/lgdt3306a.c>

```

8      jg      .L4
9      cmp    eax, 3250
10     je     .L5
11     cmp    eax, 3500
12     jne   .L2
13     mov    BYTE PTR nco1, 56
14     mov    BYTE PTR nco2, 0
15     add    esp, 12
16     ret
17 .L4:
18     cmp    eax, 5000
19     je     .L7
20     cmp    eax, 5380
21     jne   .L2
22     mov    BYTE PTR nco1, 86
23     mov    BYTE PTR nco2, 20
24     add    esp, 12
25     ret
26 .L2:
27     sub    esp, 8
28     push   eax
29     push   OFFSET FLAT:.LC0
30     call   printf
31     add    esp, 16
32 .L5:
33     mov    BYTE PTR nco1, 52
34     mov    BYTE PTR nco2, 0
35     add    esp, 12
36     ret
37 .L3:
38     mov    BYTE PTR nco1, 64
39     mov    BYTE PTR nco2, 0
40     add    esp, 12
41     ret
42 .L7:
43     mov    BYTE PTR nco1, 80
44     mov    BYTE PTR nco2, 0
45     add    esp, 12
46     ret

```

We can get to .L5 label if there is number 3250 at function's input. But we can get to this label from the other side: we see that there are no jumps between `printf()` call and .L5 label.

Now we can understand why *switch()* statement is sometimes a source of bugs: one forgotten *break* will transform your *switch()* statement into *fallthrough* one, and several blocks will be executed instead of single one.

## 1.21.5 Exercises

### Exercise#1

It's possible to rework the C example in [1.21.2 on page 167](#) in such way that the compiler can produce even smaller code, but will work just the same. Try to achieve it.

## 1.22 Loops

### 1.22.1 Simple example

#### x86

There is a special `LOOP` instruction in x86 instruction set for checking the value in register `ECX` and if it is not 0, to [decrement](#) `ECX` and pass control flow to the label in the `LOOP` operand. Probably this instruction is not very convenient, and there are no any modern compilers which emit it automatically. So, if you see this instruction somewhere in code, it is most likely that this is a manually written piece of assembly code.

In C/C++ loops are usually constructed using `for()`, `while()` or `do/while()` statements.

Let's start with `for()`.

This statement defines loop initialization (set loop counter to initial value), loop condition (is the counter bigger than a limit?), what is performed at each iteration ([increment/decrement](#)) and of course loop body.

```
for (initialization; condition; at each iteration)
{
    loop_body;
}
```

The generated code is consisting of four parts as well.

Let's start with a simple example:

```
#include <stdio.h>

void printing_function(int i)
{
    printf ("f(%d)\n", i);
};

int main()
{
    int i;

    for (i=2; i<10; i++)
        printing_function(i);

    return 0;
};
```

The result (MSVC 2010):

Listing 1.168: MSVC 2010

```
_i$ = -4
_main PROC
    push    ebp
    mov     ebp, esp
    push    ecx
    mov     DWORD PTR _i$[ebp], 2    ; loop initialization
    jmp     SHORT $LN3@main
$LN2@main:
    mov     eax, DWORD PTR _i$[ebp] ; here is what we do after each iteration:
    add     eax, 1                  ; add 1 to (i) value
    mov     DWORD PTR _i$[ebp], eax
$LN3@main:
    cmp     DWORD PTR _i$[ebp], 10 ; this condition is checked before each iteration
    jge     SHORT $LN1@main        ; if (i) is biggest or equals to 10, lets finish loop
    mov     ecx, DWORD PTR _i$[ebp] ; loop body: call printing_function(i)
    push    ecx
    call    _printing_function
    add     esp, 4
    jmp     SHORT $LN2@main        ; jump to loop begin
$LN1@main:
    xor     eax, eax                ; loop end
    mov     esp, ebp
    pop     ebp
    ret     0
_main    ENDP
```

As we see, nothing special.

GCC 4.4.1 emits almost the same code, with one subtle difference:

Listing 1.169: GCC 4.4.1

```
main          proc near

var_20        = dword ptr -20h
var_4         = dword ptr -4

                push    ebp
                mov     ebp, esp
```

```

        and     esp, 0FFFFFFF0h
        sub     esp, 20h
        mov     [esp+20h+var_4], 2 ; (i) initializing
        jmp     short loc_8048476

loc_8048465:
        mov     eax, [esp+20h+var_4]
        mov     [esp+20h+var_20], eax
        call    printing_function
        add     [esp+20h+var_4], 1 ; (i) increment

loc_8048476:
        cmp     [esp+20h+var_4], 9
        jle     short loc_8048465 ; if i<=9, continue loop
        mov     eax, 0
        leave
        retn

main     endp

```

Now let's see what we get with optimization turned on (/Ox):

Listing 1.170: Optimizing MSVC

```

_main   PROC
        push   esi
        mov    esi, 2
$LL3@main:
        push   esi
        call  _printing_function
        inc    esi
        add    esp, 4
        cmp    esi, 10 ; 0000000aH
        jl     SHORT $LL3@main
        xor    eax, eax
        pop    esi
        ret    0
_main   ENDP

```

What happens here is that space for the *i* variable is not allocated in the local stack anymore, but uses an individual register for it, ESI. This is possible in such small functions where there aren't many local variables.

One very important thing is that the `f()` function must not change the value in ESI. Our compiler is sure here. And if the compiler decides to use the ESI register in `f()` too, its value would have to be saved at the function's prologue and restored at the function's epilogue, almost like in our listing: please note PUSH ESI/POP ESI at the function start and end.

Let's try GCC 4.4.1 with maximal optimization turned on (-O3 option):

Listing 1.171: Optimizing GCC 4.4.1

```

main     proc near

var_10   = dword ptr -10h

        push   ebp
        mov    ebp, esp
        and    esp, 0FFFFFFF0h
        sub    esp, 10h
        mov    [esp+10h+var_10], 2
        call  printing_function
        mov    [esp+10h+var_10], 3
        call  printing_function
        mov    [esp+10h+var_10], 4
        call  printing_function
        mov    [esp+10h+var_10], 5
        call  printing_function
        mov    [esp+10h+var_10], 6
        call  printing_function
        mov    [esp+10h+var_10], 7
        call  printing_function

```

```

        mov     [esp+10h+var_10], 8
        call   printing_function
        mov     [esp+10h+var_10], 9
        call   printing_function
        xor     eax, eax
        leave
        retn
main     endp

```

Huh, GCC just unwound our loop.

[Loop unwinding](#) has an advantage in the cases when there aren't much iterations and we could cut some execution time by removing all loop support instructions. On the other side, the resulting code is obviously larger.

Big unrolled loops are not recommended in modern times, because bigger functions may require bigger cache footprint<sup>100</sup>.

OK, let's increase the maximum value of the *i* variable to 100 and try again. GCC does:

Listing 1.172: GCC

```

main     public main
        proc near

var_20   = dword ptr -20h

        push   ebp
        mov    ebp, esp
        and    esp, 0FFFFFF0h
        push   ebx
        mov    ebx, 2      ; i=2
        sub    esp, 1Ch

; aligning label loc_80484D0 (loop body begin) by 16-byte border:
        nop

loc_80484D0:
; pass (i) as first argument to printing_function():
        mov    [esp+20h+var_20], ebx
        add    ebx, 1      ; i++
        call   printing_function
        cmp    ebx, 64h    ; i==100?
        jnz   short loc_80484D0 ; if not, continue
        add    esp, 1Ch
        xor    eax, eax    ; return 0
        pop    ebx
        mov    esp, ebp
        pop    ebp
        retn

main     endp

```

It is quite similar to what MSVC 2010 with optimization (/Ox) produce, with the exception that the EBX register is allocated for the *i* variable.

GCC is sure this register will not be modified inside of the *f()* function, and if it will, it will be saved at the function prologue and restored at epilogue, just like here in the *main()* function.

<sup>100</sup>A very good article about it: [Ulrich Drepper, *What Every Programmer Should Know About Memory*, (2007)]<sup>101</sup>. Another recommendations about loop unrolling from Intel are here: [Intel® 64 and IA-32 Architectures Optimization Reference Manual, (2014)3.4.1.7].

## x86: OllyDbg

Let's compile our example in MSVC 2010 with /Ox and /Ob0 options and load it into OllyDbg.

It seems that OllyDbg is able to detect simple loops and show them in square brackets, for convenience:

```
CPU - main thread, module loops_2
0033101C CC INT3
0033101D CC INT3
0033101E CC INT3
0033101F CC INT3
00331020 [ 56 PUSH ESI
00331021 . BE 02000000 MOV ESI,2
00331026 > 56 PUSH ESI
00331027 . E8 D4FFFFFF CALL loops_2.00331000
0033102C . 46 INC ESI
0033102D . 83C4 04 ADD ESP,4
00331030 . 83FE 0A CMP ESI,0A
00331033 . ^7C F1 JL SHORT loops_2.00331026
00331035 . 33C0 XOR EAX,EAX
00331037 . 5E POP ESI
00331038 . C3 RETN
00331039 . 68 06143300 PUSH loops_2.00331406
0033103F . 50 CALL loops_2.00331000
ESI=00000001
Local call from 003311A1

Registers (FPU)
EAX 003128A8
ECX 6F0F4714 OFFSET MS
EDX 00000000
EBX 00000000
ESP 0024FD18
EBP 0024FD58
ESI 00000001
EDI 00333378 loops_2.0
EIP 00331020 loops_2.0
C 0 ES 002B 32bit 0(F
P 1 CS 0023 32bit 0(F
A 0 SS 002B 32bit 0(F
Z 1 DS 002B 32bit 0(F
S 0 FS 0053 32bit 7(F
T 0 GS 002B 32bit 0(F
D 0
O 0 LastErr ERROR_SUC
EFL 00000246 (NO,NB,F,
```

Figure 1.55: OllyDbg: main() begin

By tracing (F8 — step over) we see ESI [incrementing](#). Here, for instance,  $ESI = i = 6$ :

```
CPU - main thread, module loops_2
0033101C CC INT3
0033101D CC INT3
0033101E CC INT3
0033101F CC INT3
00331020 [ 56 PUSH ESI
00331021 . BE 02000000 MOV ESI,2
00331026 > 56 PUSH ESI
00331027 . E8 D4FFFFFF CALL loops_2.00331000
0033102C . 46 INC ESI
0033102D . 83C4 04 ADD ESP,4
00331030 . 83FE 0A CMP ESI,0A
00331033 . ^7C F1 JL SHORT loops_2.00331026
00331035 . 33C0 XOR EAX,EAX
00331037 . 5E POP ESI
00331038 . C3 RETN
00331039 . 68 06143300 PUSH loops_2.00331406
0033103F . 50 CALL loops_2.00331000
ESP=0024FD10

Registers (FPU)
EAX 00000005
ECX 6F0A5617 MSUCR1
EDX 000AE218
EBX 00000000
ESP 0024FD10
EBP 0024FD58
ESI 00000006
EDI 00333378 loops_
EIP 0033102D loops_
C 0 ES 002B 32bit
P 1 CS 0023 32bit
A 0 SS 002B 32bit
Z 0 DS 002B 32bit
S 0 FS 0053 32bit
T 0 GS 002B 32bit
D 0
O 0
```

Figure 1.56: OllyDbg: loop body just executed with  $i = 6$

9 is the last loop value. That's why JL is not triggering after the [increment](#), and the function will finish:

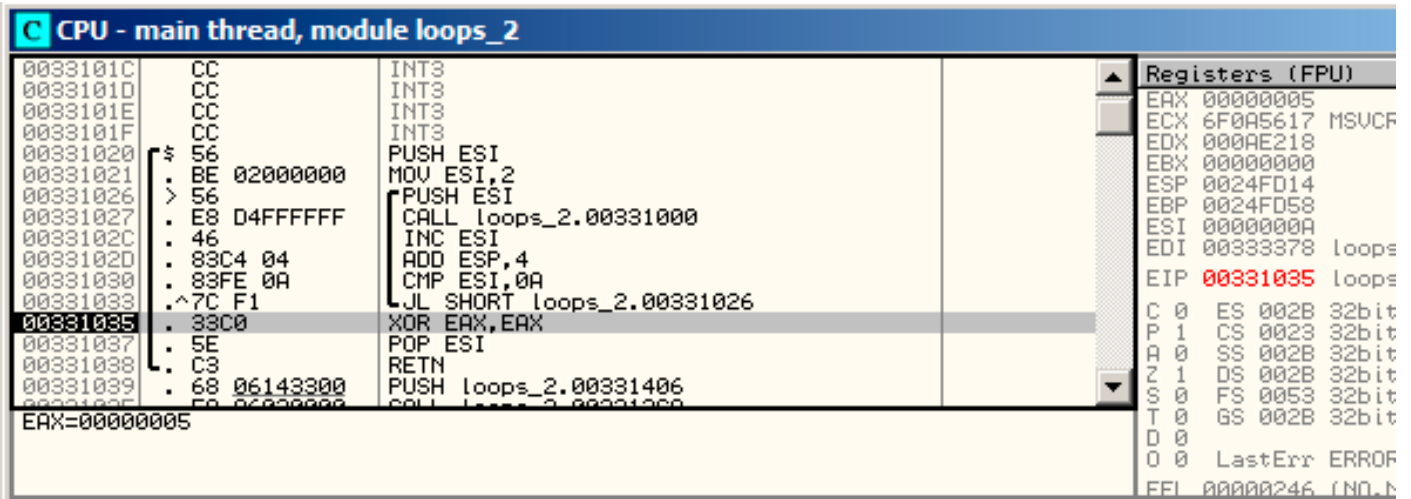

Figure 1.57: OllyDbg: *ESI* = 10, loop end

### x86: tracer

As we might see, it is not very convenient to trace manually in the debugger. That's a reason we will try [tracer](#).

We open compiled example in [IDA](#), find the address of the instruction `PUSH ESI` (passing the sole argument to `f()`), which is `0x401026` for this case and we run the [tracer](#):

```
tracer.exe -l:loops_2.exe bpx=loops_2.exe!0x00401026
```

`BPX` just sets a breakpoint at the address and [tracer](#) will then print the state of the registers.

In the `tracer.log`, this is what we see:

```
PID=12884|New process loops_2.exe
(0) loops_2.exe!0x401026
EAX=0x000a328c8 EBX=0x00000000 ECX=0x6f0f4714 EDX=0x00000000
ESI=0x00000002 EDI=0x00333378 EBP=0x0024fbfc ESP=0x0024fbb8
EIP=0x00331026
FLAGS=PF ZF IF
(0) loops_2.exe!0x401026
EAX=0x00000005 EBX=0x00000000 ECX=0x6f0a5617 EDX=0x000ee188
ESI=0x00000003 EDI=0x00333378 EBP=0x0024fbfc ESP=0x0024fbb8
EIP=0x00331026
FLAGS=CF PF AF SF IF
(0) loops_2.exe!0x401026
EAX=0x00000005 EBX=0x00000000 ECX=0x6f0a5617 EDX=0x000ee188
ESI=0x00000004 EDI=0x00333378 EBP=0x0024fbfc ESP=0x0024fbb8
EIP=0x00331026
FLAGS=CF PF AF SF IF
(0) loops_2.exe!0x401026
EAX=0x00000005 EBX=0x00000000 ECX=0x6f0a5617 EDX=0x000ee188
ESI=0x00000005 EDI=0x00333378 EBP=0x0024fbfc ESP=0x0024fbb8
EIP=0x00331026
FLAGS=CF AF SF IF
(0) loops_2.exe!0x401026
EAX=0x00000005 EBX=0x00000000 ECX=0x6f0a5617 EDX=0x000ee188
ESI=0x00000006 EDI=0x00333378 EBP=0x0024fbfc ESP=0x0024fbb8
EIP=0x00331026
FLAGS=CF PF AF SF IF
(0) loops_2.exe!0x401026
EAX=0x00000005 EBX=0x00000000 ECX=0x6f0a5617 EDX=0x000ee188
ESI=0x00000007 EDI=0x00333378 EBP=0x0024fbfc ESP=0x0024fbb8
EIP=0x00331026
FLAGS=CF AF SF IF
(0) loops_2.exe!0x401026
EAX=0x00000005 EBX=0x00000000 ECX=0x6f0a5617 EDX=0x000ee188
```

```
ESI=0x00000008 EDI=0x00333378 EBP=0x0024fbfc ESP=0x0024fbb8
EIP=0x00331026
FLAGS=CF AF SF IF
(0) loops_2.exe!0x401026
EAX=0x00000005 EBX=0x00000000 ECX=0x6f0a5617 EDX=0x000ee188
ESI=0x00000009 EDI=0x00333378 EBP=0x0024fbfc ESP=0x0024fbb8
EIP=0x00331026
FLAGS=CF PF AF SF IF
PID=12884|Process loops_2.exe exited. ExitCode=0 (0x0)
```

We see how the value of ESI register changes from 2 to 9.

Even more than that, the [tracer](#) can collect register values for all addresses within the function. This is called *trace* there. Every instruction gets traced, all interesting register values are recorded.

Then, an [IDA.idc](#)-script is generated, that adds comments. So, in the [IDA](#) we've learned that the `main()` function address is `0x00401020` and we run:

```
tracer.exe -l:loops_2.exe bpf=loops_2.exe!0x00401020,trace:cc
```

BPF stands for set breakpoint on function.

As a result, we get the `loops_2.exe.idc` and `loops_2.exe_clear.idc` scripts.



We load loops\_2.exe.idc into IDA and see:

```
.text:00401020
.text:00401020 ; ===== S U B R O U T I N E =====
.text:00401020
.text:00401020 ; int __cdecl main(int argc, const char **argv, const char **envp)
.text:00401020 _main      proc near      ; CODE XREF: ___tmainCRTStartup+11D↓p
.text:00401020          argc         = dword ptr  4
.text:00401020          argv         = dword ptr  8
.text:00401020          envp         = dword ptr 0Ch
.text:00401020          push      esi          ; ESI=1
.text:00401021          mov       esi, 2
.text:00401026          loc_401026:          ; CODE XREF: _main+13↓j
.text:00401026          push      esi          ; ESI=2..9
.text:00401027          call     sub_401000    ; tracing nested maximum level (1) reached,
.text:00401028          inc      esi          ; ESI=2..9
.text:00401029          add      esp, 4       ; ESP=0x38fcbc
.text:0040102a          cmp      esi, 0Ah     ; ESI=3..0xa
.text:0040102b          jl       short loc_401026 ; SF=false,true OF=false
.text:0040102c          xor      eax, eax
.text:0040102d          pop      esi
.text:0040102e          retn                    ; EAX=0
.text:0040102f          _main      endp
```

Figure 1.58: IDA with .idc-script loaded

We see that ESI can be from 2 to 9 at the start of the loop body, but from 3 to 0xA (10) after the increment. We can also see that main() is finishing with 0 in EAX.

tracer also generates loops\_2.exe.txt, that contains information about how many times each instruction has been executed and register values:

Listing 1.173: loops\_2.exe.txt

```
0x401020 (.text+0x20), e= 1 [PUSH ESI] ESI=1
0x401021 (.text+0x21), e= 1 [MOV ESI, 2]
0x401026 (.text+0x26), e= 8 [PUSH ESI] ESI=2..9
0x401027 (.text+0x27), e= 8 [CALL 8D1000h] tracing nested maximum level (1) reached, ↵
↳ skipping this CALL 8D1000h=0x8d1000
0x40102c (.text+0x2c), e= 8 [INC ESI] ESI=2..9
0x40102d (.text+0x2d), e= 8 [ADD ESP, 4] ESP=0x38fcbc
0x401030 (.text+0x30), e= 8 [CMP ESI, 0Ah] ESI=3..0xa
0x401033 (.text+0x33), e= 8 [JL 8D1026h] SF=false,true OF=false
0x401035 (.text+0x35), e= 1 [XOR EAX, EAX]
0x401037 (.text+0x37), e= 1 [POP ESI]
0x401038 (.text+0x38), e= 1 [RETN] EAX=0
```

We can use grep here.

## ARM

### Non-optimizing Keil 6/2013 (ARM mode)

```
main
    STMFD    SP!, {R4,LR}
    MOV     R4, #2
    B       loc_368
loc_35C    ; CODE XREF: main+1C
    MOV     R0, R4
    BL     printing_function
    ADD     R4, R4, #1
loc_368    ; CODE XREF: main+8
    CMP     R4, #0xA
```

```

BLT    loc_35C
MOV    R0, #0
LDMFD SP!, {R4,PC}

```

Iteration counter  $i$  is to be stored in the R4 register. The MOV R4, #2 instruction just initializes  $i$ . The MOV R0, R4 and BL printing\_function instructions compose the body of the loop, the first instruction preparing the argument for  $f()$  function and the second calling the function. The ADD R4, R4, #1 instruction just adds 1 to the  $i$  variable at each iteration. CMP R4, #0xA compares  $i$  with 0xA (10). The next instruction BLT (*Branch Less Than*) jumps if  $i$  is less than 10. Otherwise, 0 is to be written into R0 (since our function returns 0) and function execution finishes.

### Optimizing Keil 6/2013 (Thumb mode)

```

_main
        PUSH    {R4,LR}
        MOVS   R4, #2

loc_132
        MOVS   R0, R4
        BL     printing_function
        ADDS  R4, R4, #1
        CMP   R4, #0xA
        BLT   loc_132
        MOVS  R0, #0
        POP   {R4,PC}
; CODE XREF: _main+E

```

Practically the same.

### Optimizing Xcode 4.6.3 (LLVM) (Thumb-2 mode)

```

_main
        PUSH    {R4,R7,LR}
        MOVW   R4, #0x1124 ; "%d\n"
        MOVS   R1, #2
        MOVT.W R4, #0
        ADD   R7, SP, #4
        ADD   R4, PC
        MOV   R0, R4
        BLX  _printf
        MOV  R0, R4
        MOVS R1, #3
        BLX  _printf
        MOV  R0, R4
        MOVS R1, #4
        BLX  _printf
        MOV  R0, R4
        MOVS R1, #5
        BLX  _printf
        MOV  R0, R4
        MOVS R1, #6
        BLX  _printf
        MOV  R0, R4
        MOVS R1, #7
        BLX  _printf
        MOV  R0, R4
        MOVS R1, #8
        BLX  _printf
        MOV  R0, R4
        MOVS R1, #9
        BLX  _printf
        MOVS R0, #0
        POP   {R4,R7,PC}

```

In fact, this was in my  $f()$  function:

```

void printing_function(int i)
{
    printf ("%d\n", i);
};

```

So, LLVM not just *unrolled* the loop, but also *inlined* my very simple function `f()`, and inserted its body 8 times instead of calling it.

This is possible when the function is so simple (like mine) and when it is not called too much (like here).

## ARM64: Optimizing GCC 4.9.1

Listing 1.174: Optimizing GCC 4.9.1

```

printing_function:
; prepare second argument of printf():
    mov     w1, w0
; load address of the "f(%d)\n" string
    adrp   x0, .LC0
    add    x0, x0, :lo12:LC0
; just branch here instead of branch with link and return:
    b      printf
main:
; save FP and LR in the local stack:
    stp    x29, x30, [sp, -32]!
; set up stack frame:
    add    x29, sp, 0
; save contents of X19 register in the local stack:
    str    x19, [sp,16]
; we will use W19 register as counter.
; set initial value of 2 to it:
    mov    w19, 2
.L3:
; prepare first argument of printing_function():
    mov    w0, w19
; increment counter register.
    add    w19, w19, 1
; W0 here still holds value of counter value before increment.
    bl    printing_function
; is it end?
    cmp    w19, 10
; no, jump to the loop body begin:
    bne   .L3
; return 0
    mov    w0, 0
; restore contents of X19 register:
    ldr    x19, [sp,16]
; restore FP and LR values:
    ldp    x29, x30, [sp], 32
    ret
.LC0:
    .string "f(%d)\n"

```

## ARM64: Non-optimizing GCC 4.9.1

Listing 1.175: Non-optimizing GCC 4.9.1 -fno-inline

```

.LC0:
    .string "f(%d)\n"
printing_function:
; save FP and LR in the local stack:
    stp    x29, x30, [sp, -32]!
; set up stack frame:
    add    x29, sp, 0
; save contents of W0 register:
    str    w0, [x29,28]

```

```

; load address of the "f(%d)\n" string
    adrp    x0, .LC0
    add     x0, x0, :lo12:LC0
; reload input value from the local stack to W1 register:
    ldr     w1, [x29,28]
; call printf()
    bl     printf
; restore FP and LR values:
    ldp     x29, x30, [sp], 32
    ret

main:
; save FP and LR in the local stack:
    stp     x29, x30, [sp, -32]!
; set up stack frame:
    add     x29, sp, 0
; initialize counter
    mov     w0, 2
; store it to the place allocated for it in the local stack:
    str     w0, [x29,28]
; skip loop body and jump to the loop condition check instructions:
    b      .L3

.L4:
; load counter value to W0.
; it will be the first argument of printing_function():
    ldr     w0, [x29,28]
; call printing_function():
    bl     printing_function
; increment counter value:
    ldr     w0, [x29,28]
    add     w0, w0, 1
    str     w0, [x29,28]

.L3:
; loop condition check.
; load counter value:
    ldr     w0, [x29,28]
; is it 9?
    cmp     w0, 9
; less or equal? then jump to loop body begin:
; do nothing otherwise.
    ble     .L4
; return 0
    mov     w0, 0
; restore FP and LR values:
    ldp     x29, x30, [sp], 32
    ret

```

## MIPS

Listing 1.176: Non-optimizing GCC 4.4.5 (IDA)

```

main:
; IDA is not aware of variable names in local stack
; We gave them names manually:
i          = -0x10
saved_FP   = -8
saved_RA   = -4

; function prologue:
    addiu   $sp, -0x28
    sw     $ra, 0x28+saved_RA($sp)
    sw     $fp, 0x28+saved_FP($sp)
    move   $fp, $sp
; initialize counter at 2 and store this value in local stack
    li     $v0, 2
    sw     $v0, 0x28+i($fp)
; pseudoinstruction. "BEQ $ZERO, $ZERO, loc_9C" there in fact:
    b      loc_9C
    or     $at, $zero ; branch delay slot, NOP

```

```

loc_80:                                # CODE XREF: main+48
; load counter value from local stack and call printing_function():
    lw     $a0, 0x28+i($fp)
    jal   printing_function
    or     $at, $zero ; branch delay slot, NOP
; load counter, increment it, store it back:
    lw     $v0, 0x28+i($fp)
    or     $at, $zero ; NOP
    addiu  $v0, 1
    sw     $v0, 0x28+i($fp)

loc_9C:                                # CODE XREF: main+18
; check counter, is it 10?
    lw     $v0, 0x28+i($fp)
    or     $at, $zero ; NOP
    slti  $v0, 0xA
; if it is less than 10, jump to loc_80 (loop body begin):
    bnez  $v0, loc_80
    or     $at, $zero ; branch delay slot, NOP
; finishing, return 0:
    move  $v0, $zero
; function epilogue:
    move  $sp, $fp
    lw    $ra, 0x28+saved_RA($sp)
    lw    $fp, 0x28+saved_FP($sp)
    addiu $sp, 0x28
    jr   $ra
    or   $at, $zero ; branch delay slot, NOP

```

The instruction that's new to us is B. It is actually the pseudo instruction (BEQ).

### One more thing

In the generated code we can see: after initializing *i*, the body of the loop is not to be executed, as the condition for *i* is checked first, and only after that loop body can be executed. And that is correct.

Because, if the loop condition is not met at the beginning, the body of the loop must not be executed. This is possible in the following case:

```

for (i=0; i<total_entries_to_process; i++)
    loop_body;

```

If *total\_entries\_to\_process* is 0, the body of the loop must not be executed at all.

This is why the condition checked before the execution.

However, an optimizing compiler may swap the condition check and loop body, if it sure that the situation described here is not possible (like in the case of our very simple example and using compilers like Keil, Xcode (LLVM), MSVC in optimization mode).

## 1.22.2 Memory blocks copying routine

Real-world memory copy routines may copy 4 or 8 bytes at each iteration, use [SIMD<sup>102</sup>](#), vectorization, etc. But for the sake of simplicity, this example is the simplest possible.

```

#include <stdio.h>

void my_memcpy (unsigned char* dst, unsigned char* src, size_t cnt)
{
    size_t i;
    for (i=0; i<cnt; i++)
        dst[i]=src[i];
};

```

<sup>102</sup>Single Instruction, Multiple Data

## Straight-forward implementation

Listing 1.177: GCC 4.9 x64 optimized for size (-Os)

```
my_memcpy:
; RDI = destination address
; RSI = source address
; RDX = size of block

; initialize counter (i) at 0
xor    eax, eax
.L2:
; all bytes copied? exit then:
cmp    rax, rdx
je     .L5
; load byte at RSI+i:
mov    cl, BYTE PTR [rsi+rax]
; store byte at RDI+i:
mov    BYTE PTR [rdi+rax], cl
inc    rax ; i++
jmp    .L2
.L5:
ret
```

Listing 1.178: GCC 4.9 ARM64 optimized for size (-Os)

```
my_memcpy:
; X0 = destination address
; X1 = source address
; X2 = size of block

; initialize counter (i) at 0
mov    x3, 0
.L2:
; all bytes copied? exit then:
cmp    x3, x2
beq    .L5
; load byte at X1+i:
ldrb   w4, [x1,x3]
; store byte at X0+i:
strb   w4, [x0,x3]
add    x3, x3, 1 ; i++
b      .L2
.L5:
ret
```

Listing 1.179: Optimizing Keil 6/2013 (Thumb mode)

```
my_memcpy PROC
; R0 = destination address
; R1 = source address
; R2 = size of block

PUSH   {r4,lr}
; initialize counter (i) at 0
MOVS   r3,#0
; condition checked at the end of function, so jump there:
B      |L0.12|
|L0.6|
; load byte at R1+i:
LDRB   r4,[r1,r3]
; store byte at R0+i:
STRB   r4,[r0,r3]
; i++
ADDS   r3,r3,#1
|L0.12|
; i<size?
CMP    r3,r2
; jump to the loop begin if its so:
BCC   |L0.6|
POP    {r4,pc}
```

**ARM in ARM mode**

Keil in ARM mode takes full advantage of conditional suffixes:

Listing 1.180: Optimizing Keil 6/2013 (ARM mode)

```

my_memcpy PROC
; R0 = destination address
; R1 = source address
; R2 = size of block

; initialize counter (i) at 0
    MOV     r3,#0
|L0.4|
; all bytes copied?
    CMP     r3,r2
; the following block is executed only if less than condition,
; i.e., if R2<R3 or i<size.
; load byte at R1+i:
    LDRBCC  r12,[r1,r3]
; store byte at R0+i:
    STRBCC  r12,[r0,r3]
; i++
    ADDCC   r3,r3,#1
; the last instruction of the conditional block.
; jump to loop begin if i<size
; do nothing otherwise (i.e., if i>=size)
    BCC     |L0.4|
; return
    BX     lr
    ENDP

```

That's why there is only one branch instruction instead of 2.

**MIPS**

Listing 1.181: GCC 4.4.5 optimized for size (-Os) (IDA)

```

my_memcpy:
; jump to loop check part:
    b      loc_14
; initialize counter (i) at 0
; it will always reside in $v0:
    move   $v0, $zero ; branch delay slot

loc_8:
; CODE XREF: my_memcpy+1C
; load byte as unsigned at address in $t0 to $v1:
    lbu   $v1, 0($t0)
; increment counter (i):
    addiu $v0, 1
; store byte at $a3
    sb    $v1, 0($a3)

loc_14:
; CODE XREF: my_memcpy
; check if counter (i) in $v0 is still less then 3rd function argument ("cnt" in $a2):
    sltu  $v1, $v0, $a2
; form address of byte in source block:
    addu  $t0, $a1, $v0
; $t0 = $a1+$v0 = src+i
; jump to loop body if counter sill less then "cnt":
    bnez  $v1, loc_8
; form address of byte in destination block ($a3 = $a0+$v0 = dst+i):
    addu  $a3, $a0, $v0 ; branch delay slot
; finish if BNEZ wasnt triggered:
    jr    $ra
    or    $at, $zero ; branch delay slot, NOP

```

Here we have two new instructions: LBU (“Load Byte Unsigned”) and SB (“Store Byte”). Just like in ARM, all MIPS registers are 32-bit wide, there are no byte-wide parts like in x86. So when dealing with single bytes, we have to allocate whole 32-bit registers for them. LBU loads a byte and clears all other bits (“Unsigned”). On the other hand, LB (“Load Byte”) instruction sign-extends the loaded byte to a 32-bit value. SB just writes a byte from lowest 8 bits of register to memory.

## Vectorization

Optimizing GCC can do much more on this example: [1.36.1 on page 414](#).

### 1.22.3 Condition check

It’s important to keep in mind that in *for()* construct, condition is checked not at the end, but at the beginning, before execution of loop body. But often, it’s more convenient for compiler to check it at the end, after body. Sometimes, additional check can be appended at the beginning.

For example:

```
#include <stdio.h>

void f(int start, int finish)
{
    for (; start<finish; start++)
        printf ("%d\n", start);
};
```

Optimizing GCC 5.4.0 x64:

```
f:
; check condition (1):
    cmp     edi, esi
    jge    .L9
    push   rbp
    push   rbx
    mov    ebp, esi
    mov    ebx, edi
    sub    rsp, 8
.L5:
    mov    edx, ebx
    xor    eax, eax
    mov    esi, OFFSET FLAT:.LC0 ; "%d\n"
    mov    edi, 1
    add    ebx, 1
    call   __printf_chk
; check condition (2):
    cmp    ebp, ebx
    jne    .L5
    add    rsp, 8
    pop    rbx
    pop    rbp
.L9:
    rep   ret
```

We see two checks.

Hex-Rays (at least version 2.2.0) decompiles this as:

```
void __cdecl f(unsigned int start, unsigned int finish)
{
    unsigned int v2; // ebx@2
    __int64 v3; // rdx@3

    if ( (signed int)start < (signed int)finish )
    {
        v2 = start;
```



```

do
{
    v3 = v2++;
    _printf_chk(1LL, "%d\n", v3);
}
while ( finish != v2 );
}
}

```

In this case, *do/while()* can be replaced by *for()* without any doubt, and the first check can be removed.

### 1.22.4 Conclusion

Rough skeleton of loop from 2 to 9 inclusive:

Listing 1.182: x86

```

mov [counter], 2 ; initialization
jmp check
body:
; loop body
; do something here
; use counter variable in local stack
add [counter], 1 ; increment
check:
cmp [counter], 9
jle body

```

The increment operation may be represented as 3 instructions in non-optimized code:

Listing 1.183: x86

```

MOV [counter], 2 ; initialization
JMP check
body:
; loop body
; do something here
; use counter variable in local stack
MOV REG, [counter] ; increment
INC REG
MOV [counter], REG
check:
CMP [counter], 9
JLE body

```

If the body of the loop is short, a whole register can be dedicated to the counter variable:

Listing 1.184: x86

```

MOV EBX, 2 ; initialization
JMP check
body:
; loop body
; do something here
; use counter in EBX, but do not modify it!
INC EBX ; increment
check:
CMP EBX, 9
JLE body

```

Some parts of the loop may be generated by compiler in different order:

Listing 1.185: x86

```

MOV [counter], 2 ; initialization
JMP label_check
label_increment:
ADD [counter], 1 ; increment
label_check:
CMP [counter], 10

```

```

JGE exit
; loop body
; do something here
; use counter variable in local stack
JMP label_increment
exit:

```

Usually the condition is checked *before* loop body, but the compiler may rearrange it in a way that the condition is checked *after* loop body.

This is done when the compiler is sure that the condition is always *true* on the first iteration, so the body of the loop is to be executed at least once:

Listing 1.186: x86

```

MOV REG, 2 ; initialization
body:
; loop body
; do something here
; use counter in REG, but do not modify it!
INC REG ; increment
CMP REG, 10
JL body

```

Using the LOOP instruction. This is rare, compilers are not using it. When you see it, it's a sign that this piece of code is hand-written:

Listing 1.187: x86

```

; count from 10 to 1
MOV ECX, 10
body:
; loop body
; do something here
; use counter in ECX, but do not modify it!
LOOP body

```

ARM.

The R4 register is dedicated to counter variable in this example:

Listing 1.188: ARM

```

MOV R4, 2 ; initialization
B check
body:
; loop body
; do something here
; use counter in R4, but do not modify it!
ADD R4,R4, #1 ; increment
check:
CMP R4, #10
BLT body

```

## 1.22.5 Exercises

- <http://challenges.re/54>
- <http://challenges.re/55>
- <http://challenges.re/56>
- <http://challenges.re/57>

## 1.23 More about strings

### 1.23.1 strlen()

Let's talk about loops one more time. Often, the `strlen()` function <sup>103</sup> is implemented using a `while()` statement. Here is how it is done in the MSVC standard libraries:

```
int my_strlen (const char * str)
{
    const char *eos = str;

    while( *eos++ ) ;

    return( eos - str - 1 );
}

int main()
{
    // test
    return my_strlen("hello!");
};
```

## x86

### Non-optimizing MSVC

Let's compile:

```
_eos$ = -4          ; size = 4
_str$ = 8          ; size = 4
_strlen PROC
    push    ebp
    mov     ebp, esp
    push    ecx
    mov     eax, DWORD PTR _str$[ebp] ; place pointer to string from "str"
    mov     DWORD PTR _eos$[ebp], eax ; place it to local variable "eos"
$LN2@strlen_:
    mov     ecx, DWORD PTR _eos$[ebp] ; ECX=eos

    ; take 8-bit byte from address in ECX and place it as 32-bit value to EDX with sign
    ; extension

    movsx   edx, BYTE PTR [ecx]
    mov     eax, DWORD PTR _eos$[ebp] ; EAX=eos
    add     eax, 1                    ; increment EAX
    mov     DWORD PTR _eos$[ebp], eax ; place EAX back to "eos"
    test    edx, edx                  ; EDX is zero?
    je     SHORT $LN1@strlen_        ; yes, then finish loop
    jmp     SHORT $LN2@strlen_        ; continue loop
$LN1@strlen_:

    ; here we calculate the difference between two pointers

    mov     eax, DWORD PTR _eos$[ebp]
    sub     eax, DWORD PTR _str$[ebp]
    sub     eax, 1                    ; subtract 1 and return result
    mov     esp, ebp
    pop     ebp
    ret     0
_strlen_ ENDP
```

We get two new instructions here: `MOVSX` and `TEST`.

The first one—`MOVSX`—takes a byte from an address in memory and stores the value in a 32-bit register. `MOVSX` stands for *MOV with Sign-Extend*. `MOVSX` sets the rest of the bits, from the 8th to the 31th, to 1 if the source byte is *negative* or to 0 if is *positive*.

<sup>103</sup>counting the characters in a string in the C language

And here is why.

By default, the *char* type is signed in MSVC and GCC. If we have two values of which one is *char* and the other is *int*, (*int* is signed too), and if the first value contain -2 (coded as 0xFE) and we just copy this byte into the *int* container, it makes 0x000000FE, and this from the point of signed *int* view is 254, but not -2. In signed *int*, -2 is coded as 0xFFFFFFFF. So if we have to transfer 0xFE from a variable of *char* type to *int*, we have to identify its sign and extend it. That is what MOVZX does.

You can also read about it in “Signed number representations” section ( [2.2 on page 452](#)).

It’s hard to say if the compiler needs to store a *char* variable in EDX, it could just take a 8-bit register part (for example DL). Apparently, the compiler’s [register allocator](#) works like that.

Then we see TEST EDX, EDX. You can read more about the TEST instruction in the section about bit fields ( [1.28 on page 305](#)). Here this instruction just checks if the value in EDX equals to 0.

## Non-optimizing GCC

Let’s try GCC 4.4.1:

```
public strlen
strlen      proc near
eos         = dword ptr -4
arg_0      = dword ptr  8

        push    ebp
        mov     ebp, esp
        sub     esp, 10h
        mov     eax, [ebp+arg_0]
        mov     [ebp+eos], eax

loc_80483F0:
        mov     eax, [ebp+eos]
        movzx   eax, byte ptr [eax]
        test    al, al
        setnz   al
        add     [ebp+eos], 1
        test    al, al
        jnz     short loc_80483F0
        mov     edx, [ebp+eos]
        mov     eax, [ebp+arg_0]
        mov     ecx, edx
        sub     ecx, eax
        mov     eax, ecx
        sub     eax, 1
        leave
        retn

strlen      endp
```

The result is almost the same as in MSVC, but here we see MOVZX instead of MOVZX. MOVZX stands for *MOV with Zero-Extend*. This instruction copies a 8-bit or 16-bit value into a 32-bit register and sets the rest of the bits to 0. In fact, this instruction is convenient only because it enable us to replace this instruction pair:

```
xor eax, eax / mov al, [...].
```

On the other hand, it is obvious that the compiler could produce this code:

```
mov al, byte ptr [eax] / test al, al—it is almost the same, however, the highest bits of the EAX register will contain random noise. But let’s think it is compiler’s drawback—it cannot produce more understandable code. Strictly speaking, the compiler is not obliged to emit understandable (to humans) code at all.
```

The next new instruction for us is SETNZ. Here, if AL doesn’t contain zero, test al, al sets the ZF flag to 0, but SETNZ, if ZF==0 (NZ stands for *not zero*) sets AL to 1. Speaking in natural language, *if AL is not zero, let’s jump to loc\_80483F0*. The compiler emits some redundant code, but let’s not forget that the optimizations are turned off.

## Optimizing MSVC

Now let's compile all this in MSVC 2012, with optimizations turned on (/Ox):

Listing 1.189: Optimizing MSVC 2012 /Ob0

```
_str$ = 8 ; size = 4
_strlen PROC
    mov     edx, DWORD PTR _str$[esp-4] ; EDX -> pointer to the string
    mov     eax, edx ; move to EAX
$LL2@strlen:
    mov     cl, BYTE PTR [eax] ; CL = *EAX
    inc     eax ; EAX++
    test    cl, cl ; CL==0?
    jne     SHORT $LL2@strlen ; no, continue loop
    sub     eax, edx ; calculate pointers difference
    dec     eax ; decrement EAX
    ret     0
_strlen ENDP
```

Now it is all simpler. Needless to say, the compiler could use registers with such efficiency only in small functions with a few local variables.

INC/DEC—are [increment/decrement](#) instructions, in other words: add or subtract 1 to/from a variable.

## Optimizing MSVC + OllyDbg

We can try this (optimized) example in OllyDbg. Here is the first iteration:

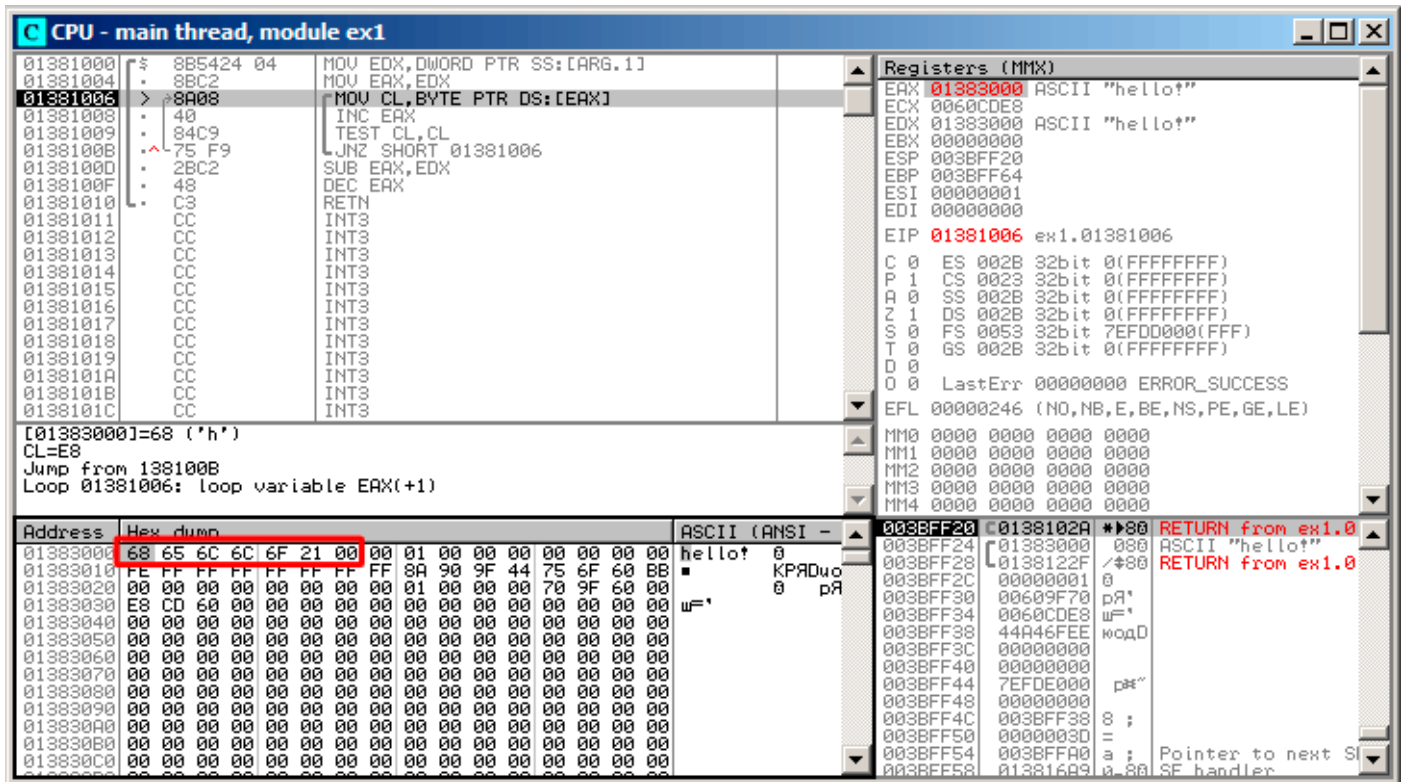

Figure 1.59: OllyDbg: first iteration start

We see that OllyDbg found a loop and, for convenience, *wrapped* its instructions in brackets. By clicking the right button on EAX, we can choose “Follow in Dump” and the memory window byte scrolls to the right place. Here we can see the string “hello!” in memory. There is at least one zero byte after it and then random garbage.

If OllyDbg sees a register with a valid address in it, that points to some string, it is shown as a string.

Let's press F8 (step over) a few times, to get to the start of the body of the loop:

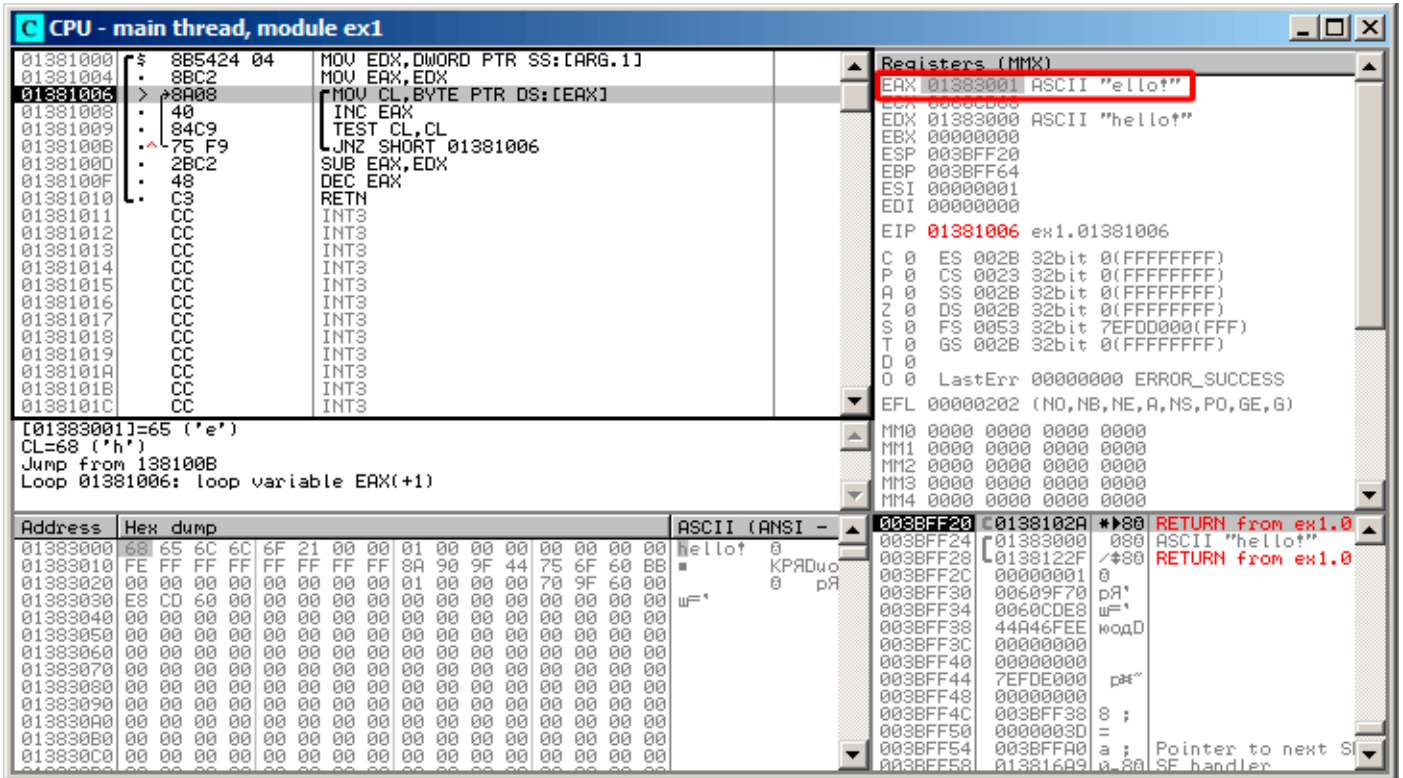

Figure 1.60: OllyDbg: second iteration start

We see that EAX contains the address of the second character in the string.

We have to press F8 enough number of times in order to escape from the loop:

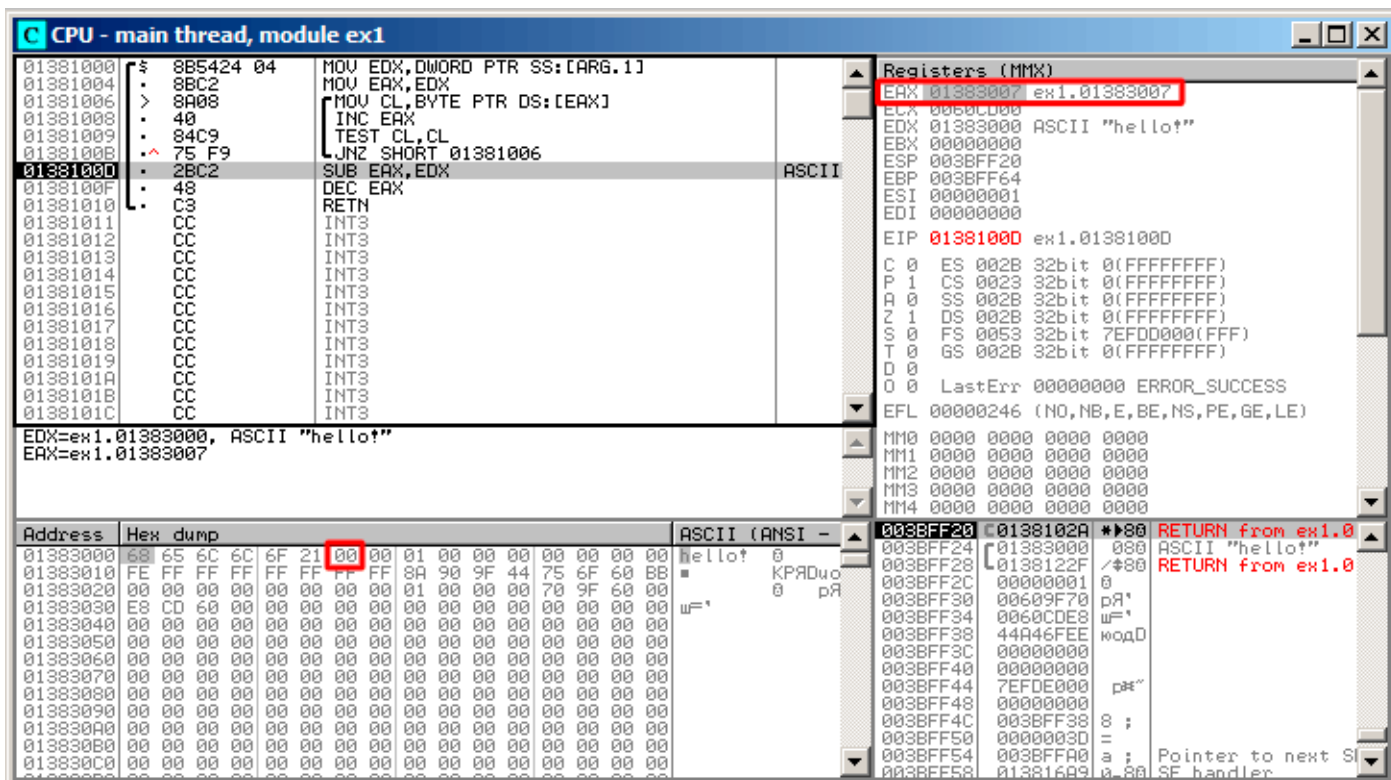

Figure 1.61: OllyDbg: pointers difference to be calculated now

We see that EAX now contains the address of zero byte that's right after the string plus 1 (because INC EAX was executed regardless of whether we exit from the loop or not). Meanwhile, EDX hasn't changed, so it still pointing to the start of the string.

The difference between these two addresses is being calculated now.



The SUB instruction just got executed:

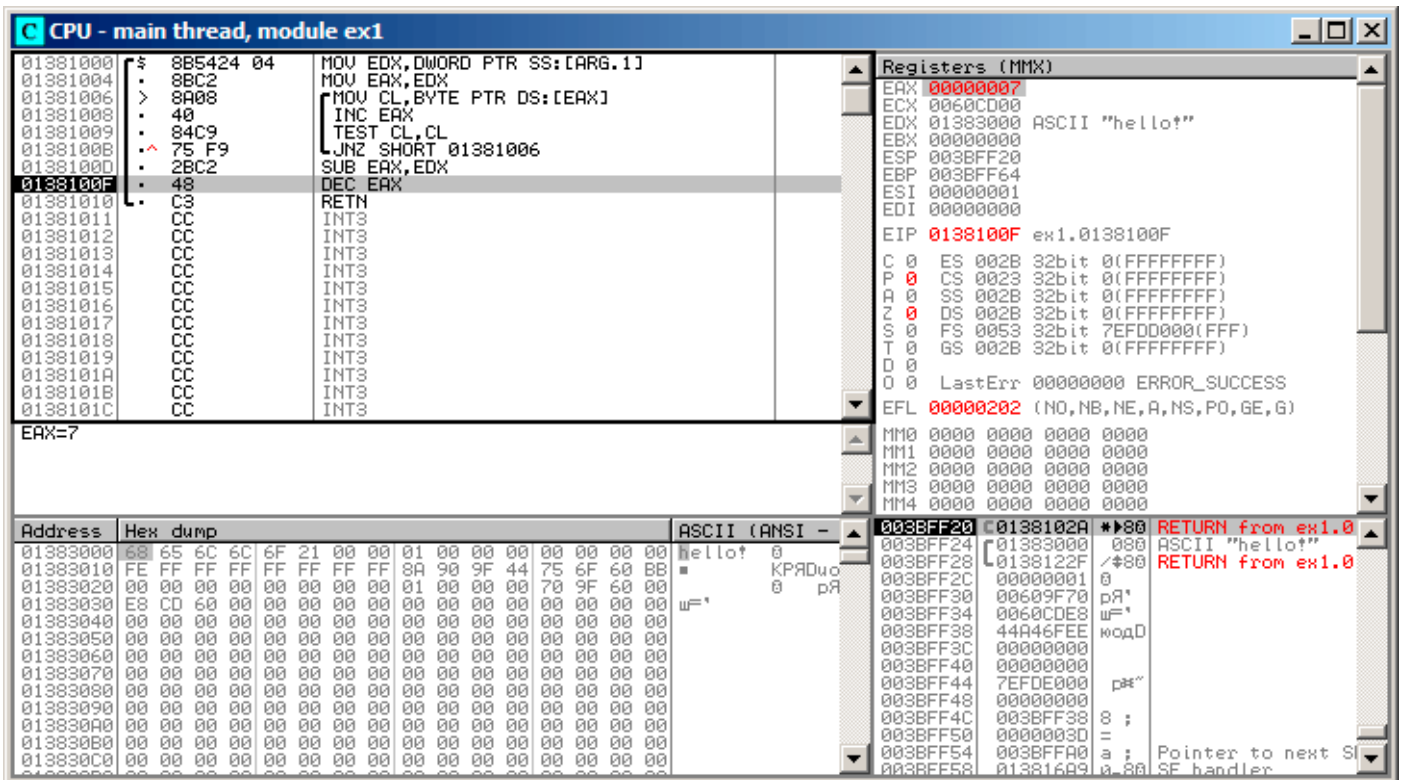

Figure 1.62: OllyDbg: EAX to be decremented now

The difference of pointers is in the EAX register now—7. Indeed, the length of the “hello!” string is 6, but with the zero byte included—7. But `strlen()` must return the number of non-zero characters in the string. So the decrement executes and then the function returns.

## Optimizing GCC

Let’s check GCC 4.4.1 with optimizations turned on (-O3 key):

```

public strlen
strlen
proc near
arg_0
    = dword ptr 8

    push    ebp
    mov     ebp, esp
    mov     ecx, [ebp+arg_0]
    mov     eax, ecx

loc_8048418:
    movzx  edx, byte ptr [eax]
    add    eax, 1
    test   dl, dl
    jnz    short loc_8048418
    not    ecx
    add    eax, ecx
    pop    ebp
    retn

strlen
endp
  
```

Here GCC is almost the same as MSVC, except for the presence of `MOVZX`. However, here `MOVZX` could be replaced with `mov dl, byte ptr [eax]`.

Perhaps it is simpler for GCC’s code generator to *remember* the whole 32-bit EDX register is allocated for a *char* variable and it then can be sure that the highest bits have no any noise at any point.

After that we also see a new instruction—NOT. This instruction inverts all bits in the operand. You can say that it is a synonym to the XOR ECX, 0fffffffh instruction. NOT and the following ADD calculate the pointer difference and subtract 1, just in a different way. At the start ECX, where the pointer to *str* is stored, gets inverted and 1 is subtracted from it.

See also: “Signed number representations” ( [2.2 on page 452](#)).

In other words, at the end of the function just after loop body, these operations are executed:

```
ecx=str;
eax=eos;
ecx=(-ecx)-1;
eax=eax+ecx
return eax
```

... and this is effectively equivalent to:

```
ecx=str;
eax=eos;
eax=eax-ecx;
eax=eax-1;
return eax
```

Why did GCC decide it would be better? Hard to guess. But perhaps the both variants are equivalent in efficiency.

## ARM

### 32-bit ARM

#### Non-optimizing Xcode 4.6.3 (LLVM) (ARM mode)

Listing 1.190: Non-optimizing Xcode 4.6.3 (LLVM) (ARM mode)

```
_strlen
eos = -8
str = -4

    SUB    SP, SP, #8 ; allocate 8 bytes for local variables
    STR    R0, [SP,#8+str]
    LDR    R0, [SP,#8+str]
    STR    R0, [SP,#8+eos]

loc_2CB8 ; CODE XREF: _strlen+28
    LDR    R0, [SP,#8+eos]
    ADD    R1, R0, #1
    STR    R1, [SP,#8+eos]
    LDRSB  R0, [R0]
    CMP    R0, #0
    BEQ    loc_2CD4
    B      loc_2CB8
loc_2CD4 ; CODE XREF: _strlen+24
    LDR    R0, [SP,#8+eos]
    LDR    R1, [SP,#8+str]
    SUB    R0, R0, R1 ; R0=eos-str
    SUB    R0, R0, #1 ; R0=R0-1
    ADD    SP, SP, #8 ; free allocated 8 bytes
    BX    LR
```

Non-optimizing LLVM generates too much code, however, here we can see how the function works with local variables in the stack. There are only two local variables in our function: *eos* and *str*. In this listing, generated by *IDA*, we have manually renamed *var\_8* and *var\_4* to *eos* and *str*.

The first instructions just saves the input values into both *str* and *eos*.

The body of the loop starts at label *loc\_2CB8*.

The first three instruction in the loop body (LDR, ADD, STR) load the value of *eos* into R0. Then the value is [incremented](#) and saved back into *eos*, which is located in the stack.

The next instruction, LDRSB R0, [R0] (“Load Register Signed Byte”), loads a byte from memory at the address stored in R0 and sign-extends it to 32-bit<sup>104</sup>. This is similar to the MOVSB instruction in x86.

The compiler treats this byte as signed since the *char* type is signed according to the C standard. It was already written about it ( [1.23.1 on page 201](#)) in this section, in relation to x86.

It has to be noted that it is impossible to use 8- or 16-bit part of a 32-bit register in ARM separately of the whole register, as it is in x86.

Apparently, it is because x86 has a huge history of backwards compatibility with its ancestors up to the 16-bit 8086 and even 8-bit 8080, but ARM was developed from scratch as a 32-bit RISC-processor.

Consequently, in order to process separate bytes in ARM, one has to use 32-bit registers anyway.

So, LDRSB loads bytes from the string into R0, one by one. The following CMP and [BEQ](#) instructions check if the loaded byte is 0. If it’s not 0, control passes to the start of the body of the loop. And if it’s 0, the loop ends.

At the end of the function, the difference between *eos* and *str* is calculated, 1 is subtracted from it, and resulting value is returned via R0.

N.B. Registers were not saved in this function.

That’s because in the ARM calling convention registers R0-R3 are “scratch registers”, intended for arguments passing, and we’re not required to restore their value when the function exits, since the calling function will not use them anymore. Consequently, they may be used for anything we want.

No other registers are used here, so that is why we have nothing to save on the stack.

Thus, control may be returned back to calling function by a simple jump (BX), to the address in the [LR](#) register.

### Optimizing Xcode 4.6.3 (LLVM) (Thumb mode)

Listing 1.191: Optimizing Xcode 4.6.3 (LLVM) (Thumb mode)

```
_strlen
    MOV     R1, R0

loc_2DF6
    LDRB.W  R2, [R1],#1
    CMP     R2, #0
    BNE     loc_2DF6
    MVNS   R0, R0
    ADD     R0, R1
    BX     LR
```

As optimizing LLVM concludes, *eos* and *str* do not need space on the stack, and can always be stored in registers.

Before the start of the loop body, *str* is always in R0, and *eos*—in R1.

The LDRB.W R2, [R1],#1 instruction loads a byte from the memory at the address stored in R1, to R2, sign-extending it to a 32-bit value, but not just that. #1 at the instruction’s end implies “Post-indexed addressing”, which means that 1 is to be added to R1 after the byte is loaded. Read more about it: [1.39.2 on page 440](#).

Then you can see CMP and [BNE<sup>105</sup>](#) in the body of the loop, these instructions continue looping until 0 is found in the string.

MVNS<sup>106</sup> (inverts all bits, like NOT in x86) and ADD instructions compute  $eos - str - 1$ . In fact, these two instructions compute  $R0 = str + eos$ , which is effectively equivalent to what was in the source code, and why it is so, was already explained here ( [1.23.1 on page 207](#)).

<sup>104</sup>The Keil compiler treats the *char* type as signed, just like MSVC and GCC.

<sup>105</sup>(PowerPC, ARM) Branch if Not Equal

<sup>106</sup>MoVe Not

Apparently, LLVM, just like GCC, concludes that this code can be shorter (or faster).

## Optimizing Keil 6/2013 (ARM mode)

Listing 1.192: Optimizing Keil 6/2013 (ARM mode)

```
_strlen
    MOV    R1, R0

loc_2C8
    LDRB   R2, [R1],#1
    CMP    R2, #0
    SUBEQ  R0, R1, R0
    SUBEQ  R0, R0, #1
    BNE    loc_2C8
    BX     LR
```

Almost the same as what we saw before, with the exception that the *str-eos-1* expression can be computed not at the function's end, but right in the body of the loop. The *-EQ* suffix, as we may recall, implies that the instruction executes only if the operands in the *CMP* that has been executed before were equal to each other. Thus, if *R0* contains 0, both *SUBEQ* instructions executes and result is left in the *R0* register.

## ARM64

### Optimizing GCC (Linaro) 4.9

```
my_strlen:
    mov     x1, x0
    ; X1 is now temporary pointer (eos), acting like cursor
.L58:
    ; load byte from X1 to W2, increment X1 (post-index)
    ldrb   w2, [x1],1
    ; Compare and Branch if NonZero: compare W2 with 0, jump to .L58 if it is not
    cbnz  w2, .L58
    ; calculate difference between initial pointer in X0 and current address in X1
    sub    x0, x1, x0
    ; decrement lowest 32-bit of result
    sub   w0, w0, #1
    ret
```

The algorithm is the same as in [1.23.1 on page 203](#): find a zero byte, calculate the difference between the pointers and decrement the result by 1. Some comments were added by the author of this book.

The only thing worth noting is that our example is somewhat wrong:

*my\_strlen()* returns 32-bit *int*, while it has to return *size\_t* or another 64-bit type.

The reason is that, theoretically, *strlen()* can be called for a huge blocks in memory that exceeds 4GB, so it must able to return a 64-bit value on 64-bit platforms.

Because of my mistake, the last *SUB* instruction operates on a 32-bit part of register, while the penultimate *SUB* instruction works on full the 64-bit register (it calculates the difference between the pointers).

It's my mistake, it is better to leave it as is, as an example of how the code could look like in such case.

### Non-optimizing GCC (Linaro) 4.9

```
my_strlen:
; function prologue
    sub    sp, sp, #32
; first argument (str) will be stored in [sp,8]
    str   x0, [sp,8]
    ldr   x0, [sp,8]
; copy "str" to "eos" variable
    str   x0, [sp,24]
```

```

        nop
.L62:
; eos++
    ldr    x0, [sp,24] ; load "eos" to X0
    add    x1, x0, 1   ; increment X0
    str    x1, [sp,24] ; save X0 to "eos"
; load byte from memory at address in X0 to W0
    ldrb   w0, [x0]
; is it zero? (WZR is the 32-bit register always contain zero)
    cmp    w0, wzr
; jump if not zero (Branch Not Equal)
    bne    .L62
; zero byte found. now calculate difference.
; load "eos" to X1
    ldr    x1, [sp,24]
; load "str" to X0
    ldr    x0, [sp,8]
; calculate difference
    sub    x0, x1, x0
; decrement result
    sub    w0, w0, #1
; function epilogue
    add    sp, sp, 32
    ret

```

It's more verbose. The variables are often tossed here to and from memory (local stack). The same mistake here: the decrement operation happens on a 32-bit register part.

## MIPS

Listing 1.193: Optimizing GCC 4.4.5 (IDA)

```

my_strlen:
; "eos" variable will always reside in $v1:
    move   $v1, $a0

loc_4:
; load byte at address in "eos" into $a1:
    lb     $a1, 0($v1)
    or     $at, $zero ; load delay slot, NOP
; if loaded byte is not zero, jump to loc_4:
    bnez   $a1, loc_4
; increment "eos" anyway:
    addiu  $v1, 1 ; branch delay slot
; loop finished. invert "str" variable:
    nor    $v0, $zero, $a0
; $v0=-str-1
    jr     $ra
; return value = $v1 + $v0 = eos + ( -str-1 ) = eos - str - 1
    addu   $v0, $v1, $v0 ; branch delay slot

```

MIPS lacks a NOT instruction, but has NOR which is OR + NOT operation.

This operation is widely used in digital electronics<sup>107</sup>. For example, the Apollo Guidance Computer used in the Apollo program, was built by only using 5600 NOR gates: [Jens Eickhoff, *Onboard Computers, Onboard Software and Satellite Operations: An Introduction*, (2011)]. But NOR element isn't very popular in computer programming.

So, the NOT operation is implemented here as NOR DST, \$ZERO, SRC.

From fundamentals [2.2 on page 452](#) we know that bitwise inverting a signed number is the same as changing its sign and subtracting 1 from the result.

So what NOT does here is to take the value of *str* and transform it into  $-str - 1$ . The addition operation that follows prepares result.

<sup>107</sup>NOR is called "universal gate"

## 1.23.2 Boundaries of strings

It's interesting to note, how parameters are passed into win32 *GetOpenFileName()* function. In order to call it, one must set list of allowed file extensions:

```
OPENFILENAME *LPOPENFILENAME;
...
char * filter = "Text files (*.txt)\0*.txt\0MS Word files (*.doc)\0*.doc\0\0";
...
LPOPENFILENAME = (OPENFILENAME *)malloc(sizeof(OPENFILENAME));
...
LPOPENFILENAME->lpstrFilter = filter;
...

if(GetOpenFileName(LPOPENFILENAME))
{
    ...
}
```

What happens here is that list of strings are passed into *GetOpenFileName()*. It is not a problem to parse it: whenever you encounter single zero byte, this is an item. Whenever you encounter two zero bytes, this is end of the list. If you will pass this string into *printf()*, it will treat first item as a single string.

So this is string, or...? It's better say this is buffer containing several zero-terminated C-strings, which can be stored and processed as a whole.

Another example is *strtok()* function. It takes a string and write zero bytes in the middle of it. It thus transforms input string into some kind of buffer, which has several zero-terminated C-strings.

## 1.24 Replacing arithmetic instructions to other ones

In the pursuit of optimization, one instruction may be replaced by another, or even with a group of instructions. For example, ADD and SUB can replace each other: line 18 in listing.3.122.

For example, the LEA instruction is often used for simple arithmetic calculations: [.1.6 on page 1029](#).

### 1.24.1 Multiplication

#### Multiplication using addition

Here is a simple example:

```
unsigned int f(unsigned int a)
{
    return a*8;
};
```

Multiplication by 8 is replaced by 3 addition instructions, which do the same. Apparently, MSVC's optimizer decided that this code can be faster.

Listing 1.194: Optimizing MSVC 2010

```
_TEXT SEGMENT
_a$ = 8 ; size = 4
_f PROC
    mov     eax, DWORD PTR _a$[esp-4]
    add     eax, eax
    add     eax, eax
    add     eax, eax
    ret     0
_f ENDP
_TEXT ENDS
END
```

## Multiplication using shifting

Multiplication and division instructions by a numbers that's a power of 2 are often replaced by shift instructions.

```
unsigned int f(unsigned int a)
{
    return a*4;
};
```

Listing 1.195: Non-optimizing MSVC 2010

```
_a$ = 8      ; size = 4
_f          PROC
    push    ebp
    mov     ebp, esp
    mov     eax, DWORD PTR _a$[ebp]
    shl    eax, 2
    pop     ebp
    ret     0
_f          ENDP
```

Multiplication by 4 is just shifting the number to the left by 2 bits and inserting 2 zero bits at the right (as the last two bits). It is just like multiplying 3 by 100 —we just have to add two zeros at the right.

That's how the shift left instruction works:

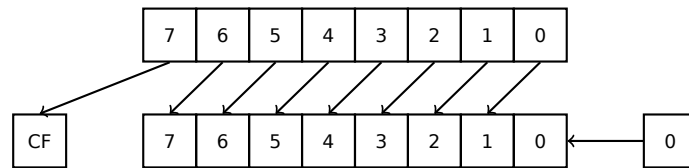

The added bits at right are always zeros.

Multiplication by 4 in ARM:

Listing 1.196: Non-optimizing Keil 6/2013 (ARM mode)

```
f PROC
    LSL    r0, r0, #2
    BX    lr
    ENDP
```

Multiplication by 4 in MIPS:

Listing 1.197: Optimizing GCC 4.4.5 (IDA)

```
jr    $ra
sll   $v0, $a0, 2 ; branch delay slot
```

SLL is “Shift Left Logical”.

## Multiplication using shifting, subtracting, and adding

It's still possible to get rid of the multiplication operation when you multiply by numbers like 7 or 17 again by using shifting. The mathematics used here is relatively easy.

## 32-bit

```
#include <stdint.h>

int f1(int a)
{
```

```

        return a*7;
};

int f2(int a)
{
    return a*28;
};

int f3(int a)
{
    return a*17;
};

```

## x86

Listing 1.198: Optimizing MSVC 2012

```

; a*7
_a$ = 8
_f1 PROC
    mov     ecx, DWORD PTR _a$[esp-4]
; ECX=a
    lea    eax, DWORD PTR [ecx*8]
; EAX=ECX*8
    sub    eax, ecx
; EAX=EAX-ECX=ECX*8-ECX=ECX*7=a*7
    ret    0
_f1 ENDP

; a*28
_a$ = 8
_f2 PROC
    mov     ecx, DWORD PTR _a$[esp-4]
; ECX=a
    lea    eax, DWORD PTR [ecx*8]
; EAX=ECX*8
    sub    eax, ecx
; EAX=EAX-ECX=ECX*8-ECX=ECX*7=a*7
    shl    eax, 2
; EAX=EAX<<2=(a*7)*4=a*28
    ret    0
_f2 ENDP

; a*17
_a$ = 8
_f3 PROC
    mov     eax, DWORD PTR _a$[esp-4]
; EAX=a
    shl    eax, 4
; EAX=EAX<<4=EAX*16=a*16
    add    eax, DWORD PTR _a$[esp-4]
; EAX=EAX+a=a*16+a=a*17
    ret    0
_f3 ENDP

```

## ARM

Keil for ARM mode takes advantage of the second operand's shift modifiers:

Listing 1.199: Optimizing Keil 6/2013 (ARM mode)

```

; a*7
||f1|| PROC
    RSB    r0, r0, r0, LSL #3
; R0=R0<<3-R0=R0*8-R0=a*8-a=a*7
    BX    lr
    ENDP

```



```

; a*28
||f2|| PROC
    RSB    r0,r0,r0,LSL #3
; R0=R0<<3-R0=R0*8-R0=a*8-a=a*7
    LSL    r0,r0,#2
; R0=R0<<2=R0*4=a*7*4=a*28
    BX     lr
    ENDP

; a*17
||f3|| PROC
    ADD    r0,r0,r0,LSL #4
; R0=R0+R0<<4=R0+R0*16=R0*17=a*17
    BX     lr
    ENDP

```

But there are no such modifiers in Thumb mode. It also can't optimize f2():

Listing 1.200: Optimizing Keil 6/2013 (Thumb mode)

```

; a*7
||f1|| PROC
    LSLS   r1,r0,#3
; R1=R0<<3=a<<3=a*8
    SUBS   r0,r1,r0
; R0=R1-R0=a*8-a=a*7
    BX     lr
    ENDP

; a*28
||f2|| PROC
    MOVS   r1,#0x1c ; 28
; R1=28
    MULS   r0,r1,r0
; R0=R1*R0=28*a
    BX     lr
    ENDP

; a*17
||f3|| PROC
    LSLS   r1,r0,#4
; R1=R0<<4=R0*16=a*16
    ADDS   r0,r0,r1
; R0=R0+R1=a+a*16=a*17
    BX     lr
    ENDP

```

## MIPS

Listing 1.201: Optimizing GCC 4.4.5 (IDA)

```

_f1:
    sll    $v0, $a0, 3
; $v0 = $a0<<3 = $a0*8
    jr     $ra
    subu   $v0, $a0 ; branch delay slot
; $v0 = $v0-$a0 = $a0*8-$a0 = $a0*7

_f2:
    sll    $v0, $a0, 5
; $v0 = $a0<<5 = $a0*32
    sll    $a0, 2
; $a0 = $a0<<2 = $a0*4
    jr     $ra
    subu   $v0, $a0 ; branch delay slot
; $v0 = $a0*32-$a0*4 = $a0*28

_f3:

```

```

        sll    $v0, $a0, 4
; $v0 = $a0<<4 = $a0*16
        jr    $ra
        addu   $v0, $a0 ; branch delay slot
; $v0 = $a0*16+$a0 = $a0*17

```

## 64-bit

```

#include <stdint.h>

int64_t f1(int64_t a)
{
    return a*7;
};

int64_t f2(int64_t a)
{
    return a*28;
};

int64_t f3(int64_t a)
{
    return a*17;
};

```

## x64

Listing 1.202: Optimizing MSVC 2012

```

; a*7
f1:
    lea    rax, [0+rdi*8]
; RAX=RDI*8=a*8
    sub    rax, rdi
; RAX=RAX-RDI=a*8-a=a*7
    ret

; a*28
f2:
    lea    rax, [0+rdi*4]
; RAX=RDI*4=a*4
    sal    rdi, 5
; RDI=RDI<<5=RDI*32=a*32
    sub    rdi, rax
; RDI=RDI-RAX=a*32-a*4=a*28
    mov    rax, rdi
    ret

; a*17
f3:
    mov    rax, rdi
    sal    rax, 4
; RAX=RAX<<4=a*16
    add    rax, rdi
; RAX=a*16+a=a*17
    ret

```

## ARM64

GCC 4.9 for ARM64 is also terse, thanks to the shift modifiers:

Listing 1.203: Optimizing GCC (Linaro) 4.9 ARM64

```

; a*7
f1:

```

```

    lsl    x1, x0, 3
; X1=X0<<3=X0*8=a*8
    sub    x0, x1, x0
; X0=X1-X0=a*8-a=a*7
    ret

; a*28
f2:
    lsl    x1, x0, 5
; X1=X0<<5=a*32
    sub    x0, x1, x0, lsl 2
; X0=X1-X0<<2=a*32-a<<2=a*32-a*4=a*28
    ret

; a*17
f3:
    add    x0, x0, x0, lsl 4
; X0=X0+X0<<4=a+a*16=a*17
    ret

```

## Booth's multiplication algorithm

There was a time when computers were big and that expensive, that some of them lacked hardware support of multiplication operation in CPU, like Data General Nova. And when one need multiplication operation, it can be provided at software level, for example, using Booth's multiplication algorithm. This is a multiplication algorithm which uses only addition operation and shifts.

What modern optimizing compilers do, isn't the same, but the goal (multiplication) and resources (faster operations) are the same.

### 1.24.2 Division

#### Division using shifts

Example of division by 4:

```

unsigned int f(unsigned int a)
{
    return a/4;
};

```

We get (MSVC 2010):

Listing 1.204: MSVC 2010

```

_a$ = 8      ; size = 4
_f          PROC
    mov     eax, DWORD PTR _a$[esp-4]
    shr    eax, 2
    ret    0
_f          ENDP

```

The SHR (*SHift Right*) instruction in this example is shifting a number by 2 bits to the right. The two freed bits at left (e.g., two most significant bits) are set to zero. The two least significant bits are dropped. In fact, these two dropped bits are the division operation remainder.

The SHR instruction works just like SHL, but in the other direction.

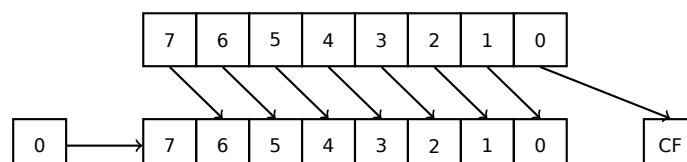

It is easy to understand if you imagine the number 23 in the decimal numeral system. 23 can be easily divided by 10 just by dropping last digit (3—division remainder). 2 is left after the operation as a **quotient**. So the remainder is dropped, but that's OK, we work on integer values anyway, these are not a **real numbers!**

Division by 4 in ARM:

Listing 1.205: Non-optimizing Keil 6/2013 (ARM mode)

```
f PROC
    LSR    r0,r0,#2
    BX    lr
    ENDP
```

Division by 4 in MIPS:

Listing 1.206: Optimizing GCC 4.4.5 (IDA)

```
jr    $ra
srl   $v0, $a0, 2 ; branch delay slot
```

The SRL instruction is “Shift Right Logical”.

### 1.24.3 Exercise

- <http://challenges.re/59>

## 1.25 Floating-point unit

The **FPU** is a device within the main **CPU**, specially designed to deal with floating point numbers. It was called “coprocessor” in the past and it stays somewhat aside of the main **CPU**.

### 1.25.1 IEEE 754

A number in the IEEE 754 format consists of a *sign*, a *significand* (also called *fraction*) and an *exponent*.

### 1.25.2 x86

It is worth looking into stack machines or learning the basics of the Forth language, before studying the **FPU** in x86.

It is interesting to know that in the past (before the 80486 CPU) the coprocessor was a separate chip and it was not always pre-installed on the motherboard. It was possible to buy it separately and install it <sup>108</sup>.

Starting with the 80486 DX CPU, the **FPU** is integrated in the **CPU**.

The FWAIT instruction reminds us of that fact—it switches the **CPU** to a waiting state, so it can wait until the **FPU** has finished with its work.

Another rudiment is the fact that the **FPU** instruction opcodes start with the so called “escape”-opcodes (D8..DF), i.e., opcodes passed to a separate coprocessor.

The FPU has a stack capable to holding 8 80-bit registers, and each register can hold a number in the IEEE 754 format.

They are ST(0)..ST(7). For brevity, **IDA** and OllyDbg show ST(0) as ST, which is represented in some textbooks and manuals as “Stack Top”.

<sup>108</sup>For example, John Carmack used fixed-point arithmetic values in his Doom video game, stored in 32-bit **GPR** registers (16 bit for integral part and another 16 bit for fractional part), so Doom could work on 32-bit computers without FPU, i.e., 80386 and 80486 SX.

### 1.25.3 ARM, MIPS, x86/x64 SIMD

In ARM and MIPS the FPU is not a stack, but a set of registers, which can be accessed randomly, like [GPR](#). The same ideology is used in the SIMD extensions of x86/x64 CPUs.

### 1.25.4 C/C++

The standard C/C++ languages offer at least two floating number types, *float* (*single-precision*, 32 bits) <sup>109</sup> and *double* (*double-precision*, 64 bits).

In [Donald E. Knuth, *The Art of Computer Programming*, Volume 2, 3rd ed., (1997)246] we can find the *single-precision* means that the floating point value can be placed into a single [32-bit] machine word, *double-precision* means it can be stored in two words (64 bits).

GCC also supports the *long double* type (*extended precision*, 80 bit), which MSVC doesn't.

The *float* type requires the same number of bits as the *int* type in 32-bit environments, but the number representation is completely different.

### 1.25.5 Simple example

Let's consider this simple example:

```
#include <stdio.h>

double f (double a, double b)
{
    return a/3.14 + b*4.1;
};

int main()
{
    printf ("%f\n", f(1.2, 3.4));
};
```

#### x86

#### MSVC

Compile it in MSVC 2010:

Listing 1.207: MSVC 2010: f()

```
CONST    SEGMENT
__real@4010666666666666 DQ 0401066666666666r    ; 4.1
CONST    ENDS
CONST    SEGMENT
__real@40091eb851eb851f DQ 040091eb851eb851fr    ; 3.14
CONST    ENDS
_TEXT    SEGMENT
_a$ = 8          ; size = 8
_b$ = 16        ; size = 8
_f PROC
    push    ebp
    mov     ebp, esp
    fld     QWORD PTR _a$[ebp]

; current stack state: ST(0) = _a

    fdiv   QWORD PTR __real@40091eb851eb851f

; current stack state: ST(0) = result of _a divided by 3.14

    fld     QWORD PTR _b$[ebp]
```

<sup>109</sup>the single precision floating point number format is also addressed in the *Handling float data type as a structure* ( [1.30.6 on page 373](#)) section

```

; current stack state: ST(0) = _b;
; ST(1) = result of _a divided by 3.14

    fmul    QWORD PTR __real@4010666666666666

; current stack state:
; ST(0) = result of _b * 4.1;
; ST(1) = result of _a divided by 3.14

    faddp  ST(1), ST(0)

; current stack state: ST(0) = result of addition

    pop    ebp
    ret    0
_f  ENDP

```

FLD takes 8 bytes from stack and loads the number into the ST(0) register, automatically converting it into the internal 80-bit format (*extended precision*).

FDIV divides the value in ST(0) by the number stored at address `__real@40091eb851eb851f` —the value 3.14 is encoded there. The assembly syntax doesn't support floating point numbers, so what we see here is the hexadecimal representation of 3.14 in 64-bit IEEE 754 format.

After the execution of FDIV ST(0) holds the [quotient](#).

By the way, there is also the FDIVP instruction, which divides ST(1) by ST(0), popping both these values from stack and then pushing the result. If you know the Forth language, you can quickly understand that this is a stack machine.

The subsequent FLD instruction pushes the value of *b* into the stack.

After that, the quotient is placed in ST(1), and ST(0) has the value of *b*.

The next FMUL instruction does multiplication: *b* from ST(0) is multiplied by value at `__real@4010666666666666` (the number 4.1 is there) and leaves the result in the ST(0) register.

The last FADDP instruction adds the two values at top of stack, storing the result in ST(1) and then popping the value of ST(0), thereby leaving the result at the top of the stack, in ST(0).

The function must return its result in the ST(0) register, so there are no any other instructions except the function epilogue after FADDP.

## MSVC + OllyDbg

2 pairs of 32-bit words are marked by red in the stack. Each pair is a double-number in IEEE 754 format and is passed from main().

We see how the first FLD loads a value (1.2) from the stack and puts it into ST(0):

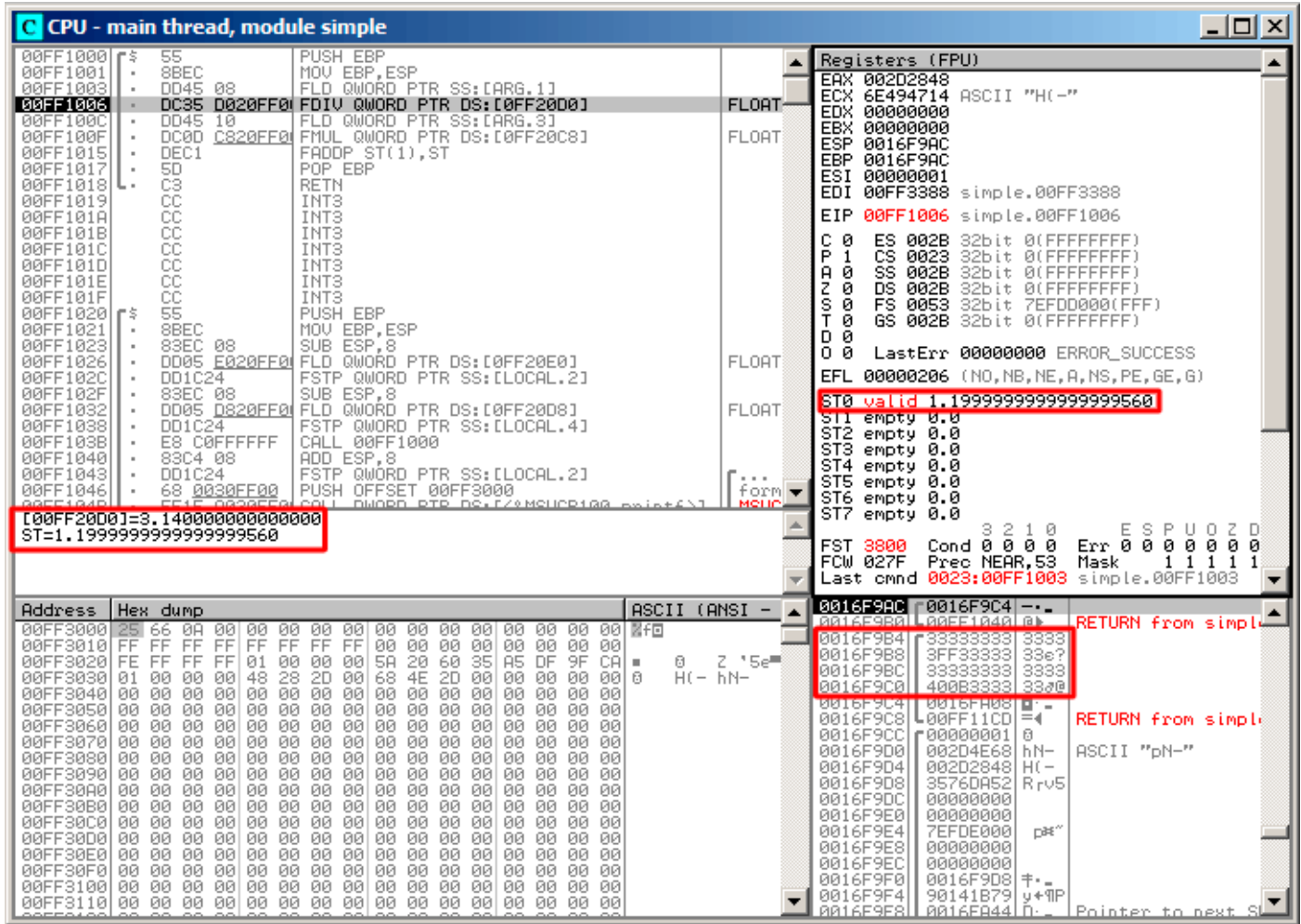

Figure 1.63: OllyDbg: the first FLD has been executed

Because of unavoidable conversion errors from 64-bit IEEE 754 floating point to 80-bit (used internally in the FPU), here we see 1.1999..., which is close to 1.2.

EIP now points to the next instruction (FDIV), which loads a double-number (a constant) from memory. For convenience, OllyDbg shows its value: 3.14

Let's trace further. FDIV has been executed, now ST(0) contains 0.382...(quotient):

The screenshot shows the OllyDbg interface with the following components:

- Assembly View:** Disassembled code for the main thread. The instruction at address 00FF100C is `FDIV QWORD PTR DS:[0FF20D0]`, which is highlighted. Other instructions include `PUSH EBP`, `MOV EBP,ESP`, `FLD QWORD PTR SS:[ARG.1]`, `FADD ST(1),ST`, `POP EBP`, `RETN`, and `INT3`.
- Registers (FPU):** A list of floating-point registers. `ST0` is highlighted with a red box and contains the value `0.3821656050955413719`. Other registers (ST1-ST7) are empty or contain 0.0.
- Stack:** The stack pointer `ESP` is at `0016F9BC`. The stack contains several instances of the string `RETURN from simple`.
- Registers (GPR):** General Purpose Registers are visible at the bottom, showing values for `EAX`, `ECX`, `EDX`, `EBX`, `ESP`, `EBP`, `ESI`, `EDI`, `EIP`, `EFL`, `FST`, `FCW`, and `Last cmd`.

Figure 1.64: OllyDbg: FDIV has been executed



Third step: the next FLD has been executed, loading 3.4 into ST(0) (here we see the approximate value 3.39999...):

The screenshot displays the OllyDbg interface with the following details:

- Assembly Window:** Shows instructions from address 00FF1000 to 00FF1046. The instruction at 00FF103E is highlighted: `FLD QWORD PTR DS:[0FF2008]`. Below it, a red box highlights the memory dump: `[00FF2008]=4.1000000000000000` and `ST=3.3999999999999999110`.
- Registers (FPU) Window:** Shows the floating-point registers. ST0 is highlighted with a red box, containing the value `3.3999999999999999110`. ST1 contains `0.3821656050955413719`. Other registers (ST2-ST7) are empty.
- Registers (GPR) Window:** Shows general-purpose registers. EIP is `00FF100F`. The instruction pointer points to the next instruction: `FMUL QWORD PTR DS:[0FF20C8]`.
- Memory Dump:** Shows hex values and ASCII characters starting from address 00FF3000.

Figure 1.65: OllyDbg: the second FLD has been executed

At the same time, *quotient* is pushed into ST(1). Right now, EIP points to the next instruction: FMUL. It loads the constant 4.1 from memory, which OllyDbg shows.

Next: FMUL has been executed, so now the `product` is in `ST(0)`:

The screenshot shows the CPU window of OllyDbg for the main thread in the 'simple' module. The assembly list shows the execution of the FMUL instruction at address 00FF100F, which multiplies the value in ST(1) by the value in ST(0). The result is stored in ST(0). The registers window shows the floating-point registers, with ST0 containing the value 13.939999999999997730 and ST1 containing 0.3821656050955413719. The stack window shows the return address 0016F9A0.

Address	Hex dump	ASCII (ANSI -)
00FF3000	25 66 0A 00 00 00 00 00 00 00 00 00 00 00 00 00	%f0
00FF3010	FF FF FF FF FF FF FF FF 00 00 00 00 00 00 00 00	0 2 '5e
00FF3020	FE FF FF FF 01 00 00 00 5A 20 60 35 A5 DF 9F CA	0 H(- hN-
00FF3030	01 00 00 00 48 28 2D 00 68 4E 2D 00 00 00 00 00	
00FF3040	00 00 00 00 00 00 00 00 00 00 00 00 00 00 00 00	
00FF3050	00 00 00 00 00 00 00 00 00 00 00 00 00 00 00 00	
00FF3060	00 00 00 00 00 00 00 00 00 00 00 00 00 00 00 00	
00FF3070	00 00 00 00 00 00 00 00 00 00 00 00 00 00 00 00	
00FF3080	00 00 00 00 00 00 00 00 00 00 00 00 00 00 00 00	
00FF3090	00 00 00 00 00 00 00 00 00 00 00 00 00 00 00 00	
00FF30A0	00 00 00 00 00 00 00 00 00 00 00 00 00 00 00 00	
00FF30B0	00 00 00 00 00 00 00 00 00 00 00 00 00 00 00 00	
00FF30C0	00 00 00 00 00 00 00 00 00 00 00 00 00 00 00 00	
00FF30D0	00 00 00 00 00 00 00 00 00 00 00 00 00 00 00 00	
00FF30E0	00 00 00 00 00 00 00 00 00 00 00 00 00 00 00 00	
00FF30F0	00 00 00 00 00 00 00 00 00 00 00 00 00 00 00 00	
00FF3100	00 00 00 00 00 00 00 00 00 00 00 00 00 00 00 00	
00FF3110	00 00 00 00 00 00 00 00 00 00 00 00 00 00 00 00	

Figure 1.66: OllyDbg: the FMUL has been executed

Next: the FADDP has been executed, now the result of the addition is in ST(0), and ST(1) is cleared:

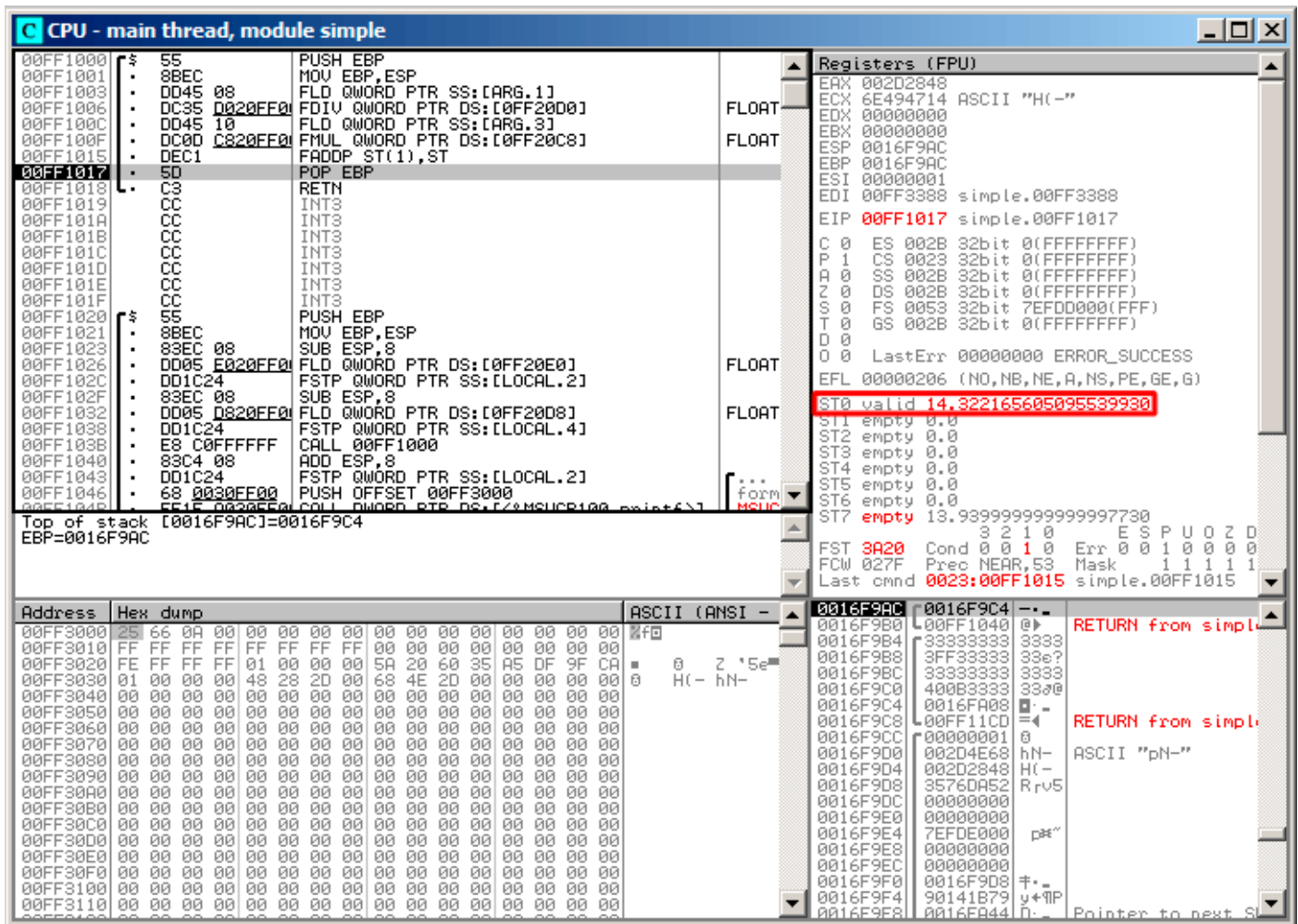

Figure 1.67: OllyDbg: FADDP has been executed

The result is left in ST(0), because the function returns its value in ST(0).

main() takes this value from the register later.

We also see something unusual: the 13.93...value is now located in ST(7). Why?

As we have read some time before in this book, the FPU registers are a stack: 1.25.2 on page 218. But this is a simplification.

Imagine if it was implemented in hardware as it's described, then all 7 register's contents must be moved (or copied) to adjacent registers during pushing and popping, and that's a lot of work.

In reality, the FPU has just 8 registers and a pointer (called TOP) which contains a register number, which is the current "top of stack".

When a value is pushed to the stack, TOP is pointed to the next available register, and then a value is written to that register.

The procedure is reversed if a value is popped, however, the register which has been freed is not cleared (it could possibly be cleared, but this is more work which can degrade performance). So that's what we see here.

It can be said that FADDP saved the sum in the stack, and then popped one element.

But in fact, this instruction saved the sum and then shifted TOP.

More precisely, the registers of the FPU are a circular buffer.

## GCC

GCC 4.4.1 (with -O3 option) emits the same code, just slightly different:

Listing 1.208: Optimizing GCC 4.4.1

```

f      public f
      proc near

arg_0  = qword ptr 8
arg_8  = qword ptr 10h

      push    ebp
      fld     ds:dbl_8048608 ; 3.14

; stack state now: ST(0) = 3.14

      mov     ebp, esp
      fdivr   [ebp+arg_0]

; stack state now: ST(0) = result of division

      fld     ds:dbl_8048610 ; 4.1

; stack state now: ST(0) = 4.1, ST(1) = result of division

      fmul    [ebp+arg_8]

; stack state now: ST(0) = result of multiplication, ST(1) = result of division

      pop     ebp
      faddp   st(1), st

; stack state now: ST(0) = result of addition

      retn
f      endp

```

The difference is that, first of all, 3.14 is pushed to the stack (into ST(0)), and then the value in arg\_0 is divided by the value in ST(0).

FDIVR stands for *Reverse Divide* —to divide with divisor and dividend swapped with each other. There is no likewise instruction for multiplication since it is a commutative operation, so we just have FMUL without its -R counterpart.

FADDP adds the two values but also pops one value from the stack. After that operation, ST(0) holds the sum.

### ARM: Optimizing Xcode 4.6.3 (LLVM) (ARM mode)

Until ARM got standardized floating point support, several processor manufacturers added their own instructions extensions. Then, VFP (*Vector Floating Point*) was standardized.

One important difference from x86 is that in ARM, there is no stack, you work just with registers.

Listing 1.209: Optimizing Xcode 4.6.3 (LLVM) (ARM mode)

```

f      VLDR     D16, =3.14
      VMOV     D17, R0, R1 ; load "a"
      VMOV     D18, R2, R3 ; load "b"
      VDIV.F64 D16, D17, D16 ; a/3.14
      VLDR     D17, =4.1
      VMUL.F64 D17, D18, D17 ; b*4.1
      VADD.F64 D16, D17, D16 ; +
      VMOV     R0, R1, D16
      BX      LR

dbl_2C98  DCFD 3.14 ; DATA XREF: f
dbl_2CA0  DCFD 4.1 ; DATA XREF: f+10

```

So, we see here new some registers used, with D prefix.

These are 64-bit registers, there are 32 of them, and they can be used both for floating-point numbers (double) but also for SIMD (it is called NEON here in ARM).

There are also 32 32-bit S-registers, intended to be used for single precision floating pointer numbers (float).

It is easy to memorize: D-registers are for double precision numbers, while S-registers—for single precision numbers. More about it: [.2.3 on page 1042](#).

Both constants (3.14 and 4.1) are stored in memory in IEEE 754 format.

VLDR and VMOV, as it can be easily deduced, are analogous to the LDR and MOV instructions, but they work with D-registers.

It has to be noted that these instructions, just like the D-registers, are intended not only for floating point numbers, but can be also used for SIMD (NEON) operations and this will also be shown soon.

The arguments are passed to the function in a common way, via the R-registers, however each number that has double precision has a size of 64 bits, so two R-registers are needed to pass each one.

VMOV D17, R0, R1 at the start, composes two 32-bit values from R0 and R1 into one 64-bit value and saves it to D17.

VMOV R0, R1, D16 is the inverse operation: what has been in D16 is split in two registers, R0 and R1, because a double-precision number that needs 64 bits for storage, is returned in R0 and R1.

VDIV, VMUL and VADD, are instruction for processing floating point numbers that compute [quotient](#), [product](#) and [sum](#), respectively.

The code for Thumb-2 is same.

### ARM: Optimizing Keil 6/2013 (Thumb mode)

```
f
    PUSH    {R3-R7,LR}
    MOVS    R7, R2
    MOVS    R4, R3
    MOVS    R5, R0
    MOVS    R6, R1
    LDR     R2, =0x66666666 ; 4.1
    LDR     R3, =0x40106666
    MOVS    R0, R7
    MOVS    R1, R4
    BL     __aeabi_dmul
    MOVS    R7, R0
    MOVS    R4, R1
    LDR     R2, =0x51EB851F ; 3.14
    LDR     R3, =0x40091EB8
    MOVS    R0, R5
    MOVS    R1, R6
    BL     __aeabi_ddiv
    MOVS    R2, R7
    MOVS    R3, R4
    BL     __aeabi_dadd
    POP     {R3-R7,PC}

; 4.1 in IEEE 754 form:
dword_364    DCD 0x66666666          ; DATA XREF: f+A
dword_368    DCD 0x40106666          ; DATA XREF: f+C
; 3.14 in IEEE 754 form:
dword_36C    DCD 0x51EB851F          ; DATA XREF: f+1A
dword_370    DCD 0x40091EB8          ; DATA XREF: f+1C
```

Keil generated code for a processor without FPU or NEON support.

The double-precision floating-point numbers are passed via generic R-registers, and instead of FPU-instructions, service library functions are called (like `__aeabi_dmul`, `__aeabi_ddiv`, `__aeabi_dadd`) which emulate multiplication, division and addition for floating-point numbers.

Of course, that is slower than FPU-coprocessor, but it's still better than nothing.

By the way, similar FPU-emulating libraries were very popular in the x86 world when coprocessors were rare and expensive, and were installed only on expensive computers.

The FPU-coprocessor emulation is called *soft float* or *armel (emulation)* in the ARM world, while using the coprocessor's FPU-instructions is called *hard float* or *armhf*.

#### ARM64: Optimizing GCC (Linaro) 4.9

Very compact code:

Listing 1.210: Optimizing GCC (Linaro) 4.9

```
f:
; D0 = a, D1 = b
    ldr    d2, .LC25        ; 3.14
; D2 = 3.14
    fdiv   d0, d0, d2
; D0 = D0/D2 = a/3.14
    ldr    d2, .LC26        ; 4.1
; D2 = 4.1
    fmadd  d0, d1, d2, d0
; D0 = D1*D2+D0 = b*4.1+a/3.14
    ret

; constants in IEEE 754 format:
.LC25:
    .word  1374389535      ; 3.14
    .word  1074339512
.LC26:
    .word  1717986918      ; 4.1
    .word  1074816614
```

#### ARM64: Non-optimizing GCC (Linaro) 4.9

Listing 1.211: Non-optimizing GCC (Linaro) 4.9

```
f:
    sub    sp, sp, #16
    str    d0, [sp,8]      ; save "a" in Register Save Area
    str    d1, [sp]       ; save "b" in Register Save Area
    ldr    x1, [sp,8]
; X1 = a
    ldr    x0, .LC25
; X0 = 3.14
    fmov   d0, x1
    fmov   d1, x0
; D0 = a, D1 = 3.14
    fdiv   d0, d0, d1
; D0 = D0/D1 = a/3.14

    fmov   x1, d0
; X1 = a/3.14
    ldr    x2, [sp]
; X2 = b
    ldr    x0, .LC26
; X0 = 4.1
    fmov   d0, x2
; D0 = b
    fmov   d1, x0
; D1 = 4.1
    fmul   d0, d0, d1
; D0 = D0*D1 = b*4.1

    fmov   x0, d0
; X0 = D0 = b*4.1
    fmov   d0, x1
; D0 = a/3.14
    fmov   d1, x0
; D1 = X0 = b*4.1
    fadd   d0, d0, d1
; D0 = D0+D1 = a/3.14 + b*4.1
```

```

    fmov    x0, d0 ; \ redundant code
    fmov    d0, x0 ; /
    add     sp, sp, 16
    ret
.LC25:
    .word   1374389535      ; 3.14
    .word   1074339512
.LC26:
    .word   1717986918     ; 4.1
    .word   1074816614

```

Non-optimizing GCC is more verbose.

There is a lot of unnecessary value shuffling, including some clearly redundant code (the last two FMOV instructions). Probably, GCC 4.9 is not yet good in generating ARM64 code.

What is worth noting is that ARM64 has 64-bit registers, and the D-registers are 64-bit ones as well.

So the compiler is free to save values of type *double* in [GPRs](#) instead of the local stack. This isn't possible on 32-bit CPUs.

And again, as an exercise, you can try to optimize this function manually, without introducing new instructions like FMADD.

### 1.25.6 Passing floating point numbers via arguments

```

#include <math.h>
#include <stdio.h>

int main ()
{
    printf ("32.01 ^ 1.54 = %lf\n", pow (32.01,1.54));

    return 0;
}

```

## x86

Let's see what we get in (MSVC 2010):

Listing 1.212: MSVC 2010

```

CONST    SEGMENT
__real@40400147ae147ae1 DQ 040400147ae147ae1r    ; 32.01
__real@3ff8a3d70a3d70a4 DQ 03ff8a3d70a3d70a4r  ; 1.54
CONST    ENDS

_main    PROC
    push    ebp
    mov     ebp, esp
    sub     esp, 8 ; allocate space for the first variable
    fld     QWORD PTR __real@3ff8a3d70a3d70a4
    fstp    QWORD PTR [esp]
    sub     esp, 8 ; allocate space for the second variable
    fld     QWORD PTR __real@40400147ae147ae1
    fstp    QWORD PTR [esp]
    call    _pow
    add     esp, 8 ; return back place of one variable.

; in local stack here 8 bytes still reserved for us.
; result now in ST(0)

    fstp    QWORD PTR [esp] ; move result from ST(0) to local stack for printf()
    push    OFFSET $SG2651
    call    _printf
    add     esp, 12
    xor     eax, eax
    pop     ebp
    ret     0
_main    ENDP

```

FLD and FSTP move variables between the data segment and the FPU stack. `pow()`<sup>110</sup> takes both values from the stack and returns its result in the ST(0) register. `printf()` takes 8 bytes from the local stack and interprets them as *double* type variable.

By the way, a pair of MOV instructions could be used here for moving values from the memory into the stack, because the values in memory are stored in IEEE 754 format, and `pow()` also takes them in this format, so no conversion is necessary. That's how it's done in the next example, for ARM: 1.25.6.

### ARM + Non-optimizing Xcode 4.6.3 (LLVM) (Thumb-2 mode)

```

_main
var_C      = -0xC

        PUSH    {R7,LR}
        MOV     R7, SP
        SUB     SP, SP, #4
        VLDR   D16, =32.01
        VMOV   R0, R1, D16
        VLDR   D16, =1.54
        VMOV   R2, R3, D16
        BLX    _pow
        VMOV   D16, R0, R1
        MOV    R0, 0xFC1 ; "32.01 ^ 1.54 = %lf\n"
        ADD   R0, PC
        VMOV   R1, R2, D16
        BLX    _printf
        MOVS  R1, 0
        STR   R0, [SP,#0xC+var_C]
        MOV   R0, R1
        ADD  SP, SP, #4
        POP  {R7,PC}

dbl_2F90  DCFD 32.01      ; DATA XREF: _main+6
dbl_2F98  DCFD 1.54      ; DATA XREF: _main+E

```

As it was mentioned before, 64-bit floating pointer numbers are passed in R-registers pairs.

This code is a bit redundant (certainly because optimization is turned off), since it is possible to load values into the R-registers directly without touching the D-registers.

So, as we see, the `_pow` function receives its first argument in R0 and R1, and its second one in R2 and R3. The function leaves its result in R0 and R1. The result of `_pow` is moved into D16, then in the R1 and R2 pair, from where `printf()` takes the resulting number.

### ARM + Non-optimizing Keil 6/2013 (ARM mode)

```

_main
        STMFD  SP!, {R4-R6,LR}
        LDR   R2, =0xA3D70A4 ; y
        LDR   R3, =0x3FF8A3D7
        LDR   R0, =0xAE147AE1 ; x
        LDR   R1, =0x40400147
        BL    pow
        MOV   R4, R0
        MOV   R2, R4
        MOV   R3, R1
        ADR   R0, a32_011_54Lf ; "32.01 ^ 1.54 = %lf\n"
        BL   __2printf
        MOV   R0, #0
        LDMFD SP!, {R4-R6,PC}

y          DCD 0xA3D70A4      ; DATA XREF: _main+4
dword_520  DCD 0x3FF8A3D7    ; DATA XREF: _main+8
x          DCD 0xAE147AE1    ; DATA XREF: _main+C
dword_528  DCD 0x40400147    ; DATA XREF: _main+10
a32_011_54Lf  DCB "32.01 ^ 1.54 = %lf",0xA,0

```

<sup>110</sup>a standard C function, raises a number to the given power (exponentiation)



D-registers are not used here, just R-register pairs.

## ARM64 + Optimizing GCC (Linaro) 4.9

Listing 1.213: Optimizing GCC (Linaro) 4.9

```
f:
    stp    x29, x30, [sp, -16]!
    add    x29, sp, 0
    ldr    d1, .LC1 ; load 1.54 into D1
    ldr    d0, .LC0 ; load 32.01 into D0
    bl    pow
; result of pow() in D0
    adrp   x0, .LC2
    add    x0, x0, :lo12:.LC2
    bl    printf
    mov    w0, 0
    ldp    x29, x30, [sp], 16
    ret

.LC0:
; 32.01 in IEEE 754 format
    .word  -1374389535
    .word  1077936455

.LC1:
; 1.54 in IEEE 754 format
    .word  171798692
    .word  1073259479

.LC2:
    .string "32.01 ^ 1.54 = %lf\n"
```

The constants are loaded into D0 and D1: `pow()` takes them from there. The result will be in D0 after the execution of `pow()`. It is to be passed to `printf()` without any modification and moving, because `printf()` takes arguments of [integral types](#) and pointers from X-registers, and floating point arguments from D-registers.

### 1.25.7 Comparison example

Let's try this:

```
#include <stdio.h>

double d_max (double a, double b)
{
    if (a>b)
        return a;

    return b;
};

int main()
{
    printf ("%f\n", d_max (1.2, 3.4));
    printf ("%f\n", d_max (5.6, -4));
};
```

Despite the simplicity of the function, it will be harder to understand how it works.

## x86

### Non-optimizing MSVC

MSVC 2010 generates the following:

Listing 1.214: Non-optimizing MSVC 2010

```

PUBLIC    _d_max
_TEXT    SEGMENT
_a$ = 8          ; size = 8
_b$ = 16        ; size = 8
_d_max    PROC
    push    ebp
    mov     ebp, esp
    fld     QWORD PTR _b$[ebp]

; current stack state: ST(0) = _b
; compare _b (ST(0)) and _a, and pop register

    fcomp   QWORD PTR _a$[ebp]

; stack is empty here

    fnstsw ax
    test   ah, 5
    jp     SHORT $LN1@d_max

; we are here only if a>b

    fld     QWORD PTR _a$[ebp]
    jmp     SHORT $LN2@d_max
$LN1@d_max:
    fld     QWORD PTR _b$[ebp]
$LN2@d_max:
    pop     ebp
    ret     0
_d_max    ENDP

```

So, FLD loads `_b` into `ST(0)`.

FCOMP compares the value in `ST(0)` with what is in `_a` and sets C3/C2/C0 bits in FPU status word register, accordingly. This is a 16-bit register that reflects the current state of the FPU.

After the bits are set, the FCOMP instruction also pops one variable from the stack. This is what distinguishes it from FCOM, which is just compares values, leaving the stack in the same state.

Unfortunately, CPUs before Intel P6 <sup>111</sup> don't have any conditional jumps instructions which check the C3/C2/C0 bits. Perhaps, it is a matter of history (recall: FPU was a separate chip in past).

Modern CPU starting at Intel P6 have FCOMI/FCOMIP/FUCOMI/FUCOMIP instructions —which do the same, but modify the ZF/PF/CF CPU flags.

The FNSTSW instruction copies FPU the status word register to AX. C3/C2/C0 bits are placed at positions 14/10/8, they are at the same positions in the AX register and all they are placed in the high part of AX —AH.

- If  $b > a$  in our example, then C3/C2/C0 bits are to be set as following: 0, 0, 0.
- If  $a > b$ , then the bits are: 0, 0, 1.
- If  $a = b$ , then the bits are: 1, 0, 0.
- If the result is unordered (in case of error), then the set bits are: 1, 1, 1.

This is how C3/C2/C0 bits are located in the AX register:

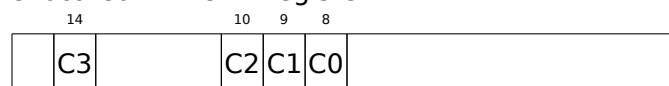

This is how C3/C2/C0 bits are located in the AH register:

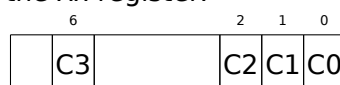

After the execution of `test ah, 5112`, only C0 and C2 bits (on 0 and 2 position) are considered, all other bits are just ignored.

Now let's talk about the *parity flag*, another notable historical rudiment.

<sup>111</sup>Intel P6 is Pentium Pro, Pentium II, etc.

<sup>112</sup>5=101b

This flag is set to 1 if the number of ones in the result of the last calculation is even, and to 0 if it is odd.

Let's look into Wikipedia<sup>113</sup>:

One common reason to test the parity flag actually has nothing to do with parity. The FPU has four condition flags (C0 to C3), but they cannot be tested directly, and must instead be first copied to the flags register. When this happens, C0 is placed in the carry flag, C2 in the parity flag and C3 in the zero flag. The C2 flag is set when e.g. incomparable floating point values (NaN or unsupported format) are compared with the FUCOM instructions.

As noted in Wikipedia, the parity flag used sometimes in FPU code, let's see how.

The PF flag is to be set to 1 if both C0 and C2 are set to 0 or both are 1, in which case the subsequent JP (*jump if PF==1*) is triggering. If we recall the values of C3/C2/C0 for various cases, we can see that the conditional jump JP is triggering in two cases: if  $b > a$  or  $a = b$  (C3 bit is not considered here, since it has been cleared by the test ah, 5 instruction).

It is all simple after that. If the conditional jump has been triggered, FLD loads the value of \_b in ST(0), and if it hasn't been triggered, the value of \_a is loaded there.

### **And what about checking C2?**

The C2 flag is set in case of error (NaN, etc.), but our code doesn't check it.

If the programmer cares about FPU errors, he/she must add additional checks.

---

<sup>113</sup>[https://en.wikipedia.org/wiki/Parity\\_flag](https://en.wikipedia.org/wiki/Parity_flag)

## First OllyDbg example: a=1.2 and b=3.4

Let's load the example into OllyDbg:

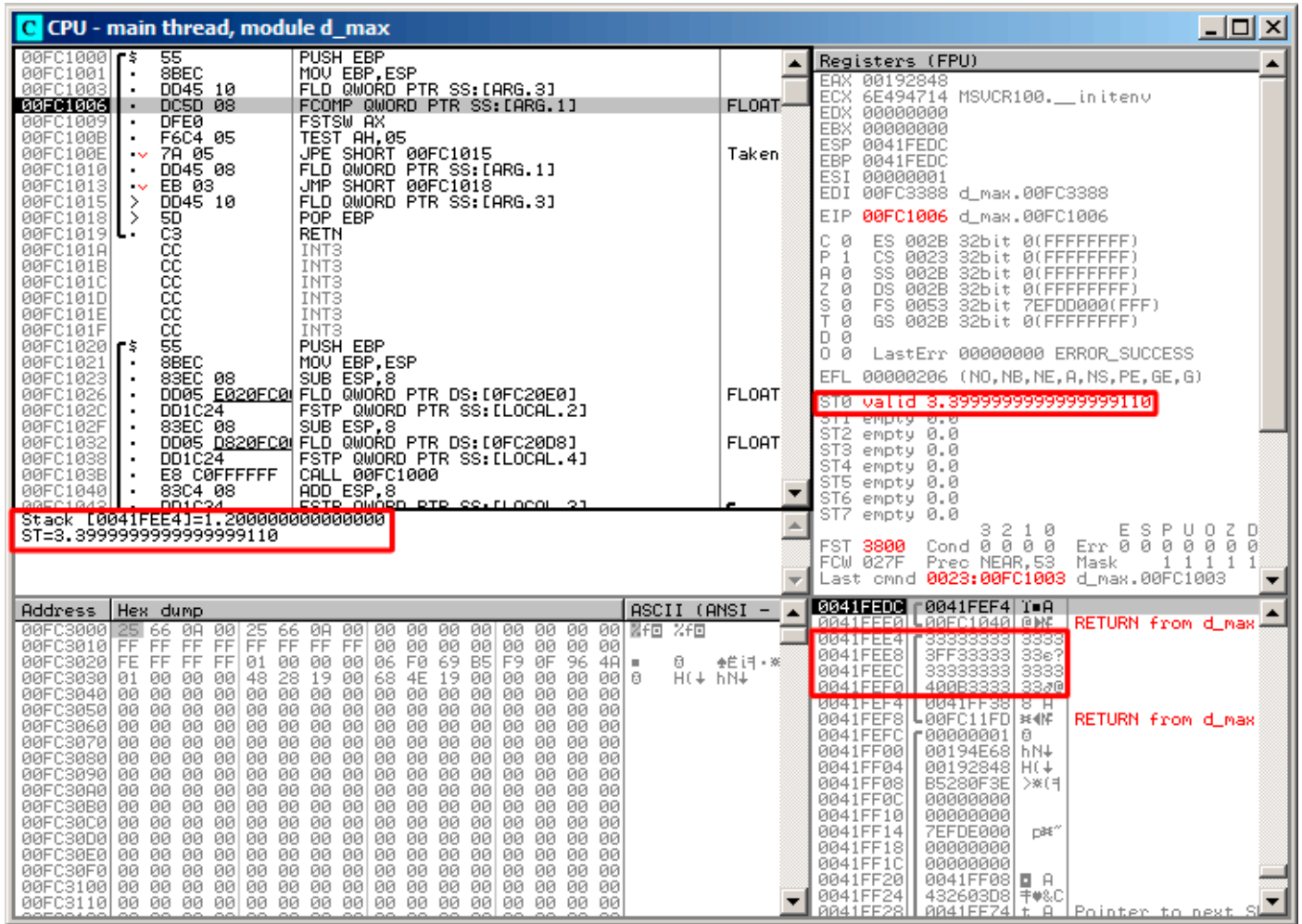

Figure 1.68: OllyDbg: first FLD has been executed

Current arguments of the function:  $a = 1.2$  and  $b = 3.4$  (We can see them in the stack: two pairs of 32-bit values).  $b$  (3.4) is already loaded in `ST(0)`. Now `FCOMP` is being executed. OllyDbg shows the second `FCOMP` argument, which is in stack right now.

FCOMP has been executed:

The screenshot displays the OllDbg interface for the CPU - main thread, module d\_max. The main window shows the disassembly of the FCMP instruction at address 00FC1009, which is marked as 'Taken'. The registers window shows the FPU registers, with the condition code register (FST) highlighted in red, showing a value of 0000. The disassembly window shows the instruction FSTP QWORD PTR DS:[LOCAL.2] at address 00FC1022. The status bar at the bottom shows the address 0041FEED and the instruction RETURN from d\_max.

Figure 1.69: OllDbg: FCMP has been executed

We see the state of the FPU's condition flags: all zeros. The popped value is reflected as ST(7), it was written earlier about reason for this: [1.25.5 on page 225](#).

FNSTSW has been executed:

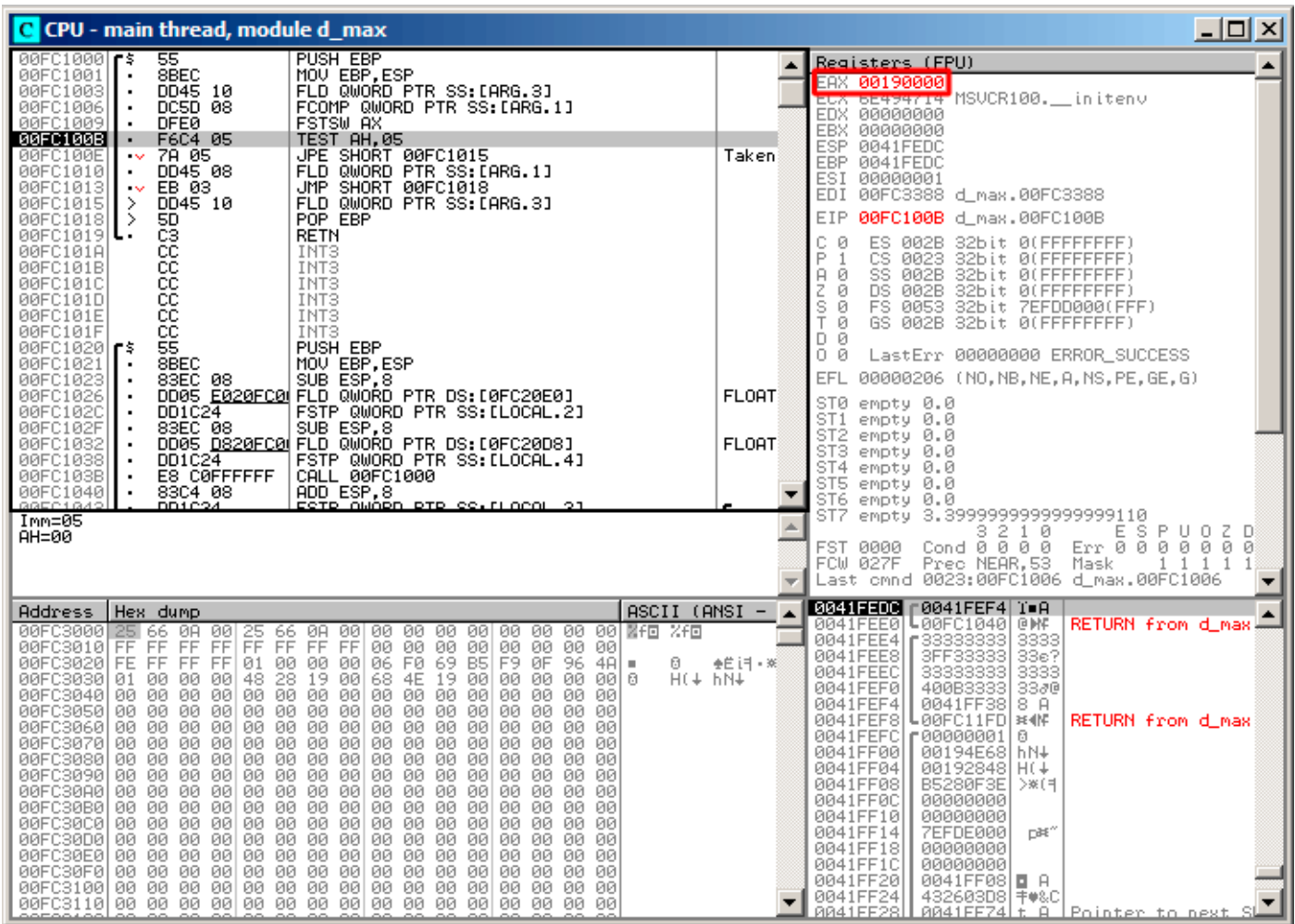

Figure 1.70: OllyDbg: FNSTSW has been executed

We see that the AX register contain zeros: indeed, all condition flags are zero. (OllyDbg disassembles the FNSTSW instruction as FSTSW—they are synonyms).

TEST has been executed:

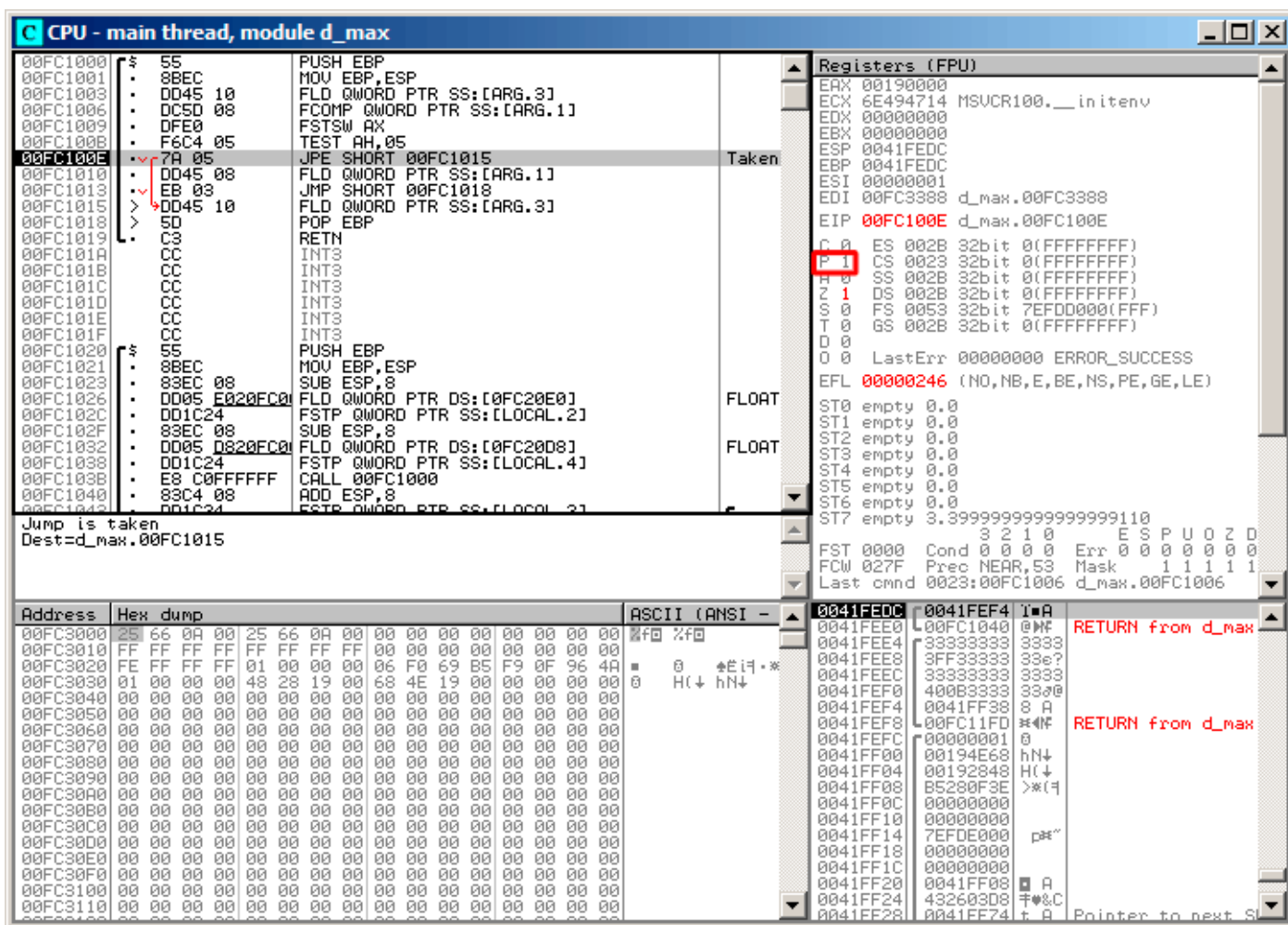

Figure 1.71: OllyDbg: TEST has been executed

The PF flag is set to 1.

Indeed: the number of bits set in 0 is 0 and 0 is an even number. OllyDbg disassembles JP as `JPE`<sup>114</sup>—they are synonyms. And it is about to trigger now.

<sup>114</sup>Jump Parity Even (x86 instruction)

JPE triggered, FLD loads the value of *b* (3.4) in ST(0):

The screenshot shows the CPU window for the main thread in module d\_max. The assembly code is as follows:

```

00FC1000 55          PUSH EBP
00FC1001 8BEC      MOV EBP,ESP
00FC1003 DD45 10    FLD QWORD PTR SS:[ARG.3]
00FC1006 DC5D 08    FCOMP QWORD PTR SS:[ARG.1]
00FC1009 DFE0      FSTSW AX
00FC100B F6C4 05    TEST AH,05
00FC100E 7A 05     JPE SHORT 00FC1015
00FC1010 DD45 08    FLD QWORD PTR SS:[ARG.1]
00FC1013 EB 03     JMP SHORT 00FC1018
00FC1015 DD45 10    FLD QWORD PTR SS:[ARG.3]
00FC1018 5D        POP EBP
00FC1019 C3        RETN
00FC101A CC        INT3
00FC101B CC        INT3
00FC101C CC        INT3
00FC101D CC        INT3
00FC101E CC        INT3
00FC101F CC        INT3
00FC1020 55          PUSH EBP
00FC1021 8BEC      MOV EBP,ESP
00FC1023 83EC 08    SUB ESP,8
00FC1026 DD05 0020FC00 FLD QWORD PTR DS:[0FC20E0]
00FC102C DD1C24    FSTP QWORD PTR SS:[LOCAL.2]
00FC102F 83EC 08    SUB ESP,8
00FC1032 DD05 0820FC00 FLD QWORD PTR DS:[0FC20D8]
00FC1038 DD1C24    FSTP QWORD PTR SS:[LOCAL.4]
00FC103B E8 C0FFFFFF CALL 00FC1000
00FC1040 83C4 08    ADD ESP,8
00FC1042 DD1C24    FSTP QWORD PTR SS:[LOCAL.2]
  
```

The Registers (FPU) window shows the following values:

```

EAX 00190000
ECX 6E494714 MSUCR100.__initenv
EDX 00000000
EBX 00000000
ESP 0041FEE0
EBP 0041FEF4
ESI 00000001
EDI 00FC3388 d_max.00FC3388
EIP 00FC1019 d_max.00FC1019
  
```

The ST0 register is highlighted with a red box and contains the value 3.3999999999999999110.

The stack dump shows the return address 0041FEE0, which is labeled as RETURN from d\_max.

Figure 1.72: OllyDbg: the second FLD has been executed

The function finishes its work.



## Second OllyDbg example: a=5.6 and b=-4

Let's load example into OllyDbg:

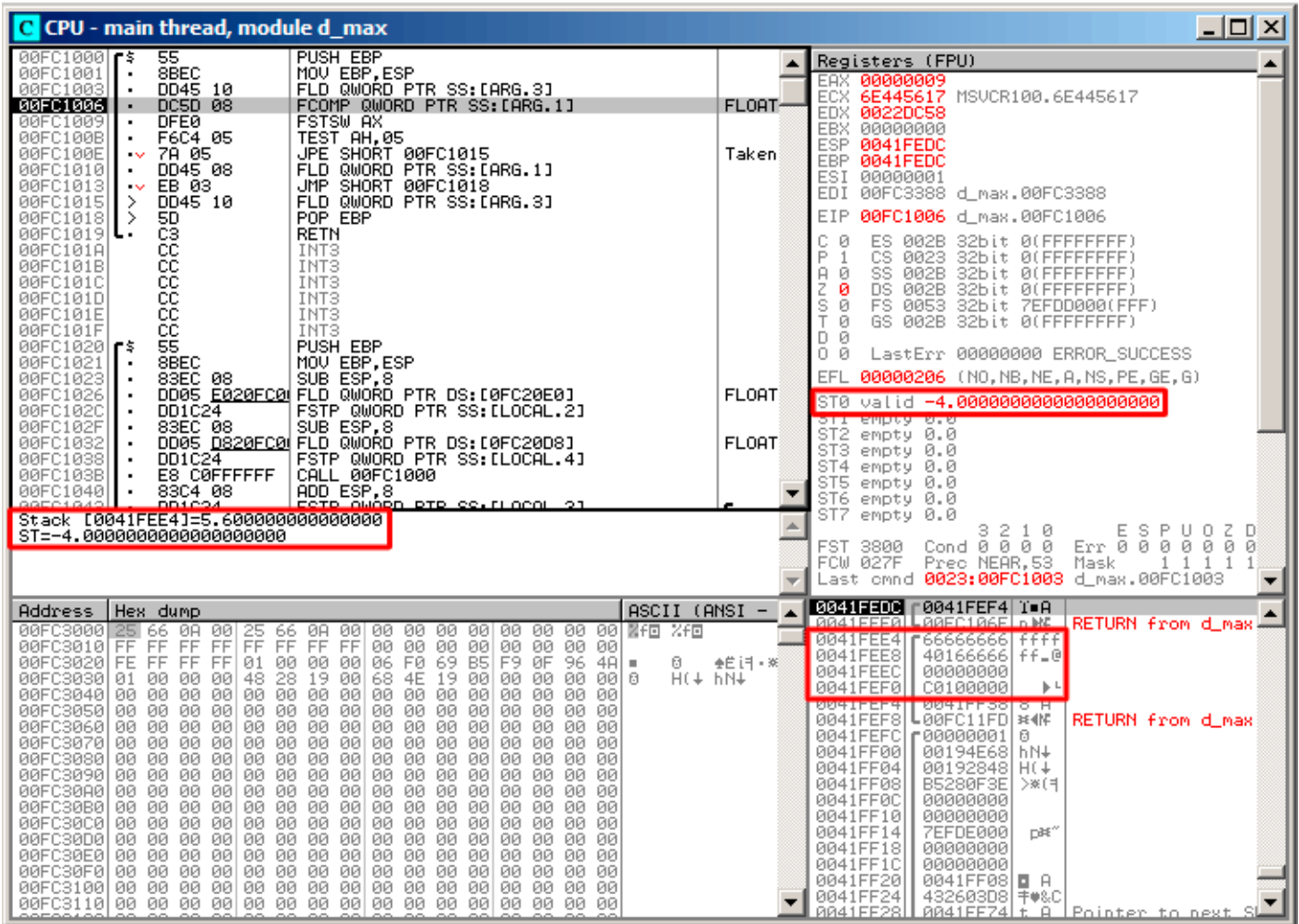

Figure 1.73: OllyDbg: first FLD executed

Current function arguments:  $a = 5.6$  and  $b = -4$ .  $b$  (-4) is already loaded in ST(0). FCOMP about to execute now. OllyDbg shows the second FCOMP argument, which is in stack right now.

FCOMP executed:

The screenshot shows the OllyDbg interface with the following details:

- CPU - main thread, module d\_max:**
  - Address 00FC1009: `FCOMP QWORD PTR SS:[ARG.3]` (Taken)
  - Registers (FPU):
    - C 0: ES 002B 32bit 0 (FFFFFFFF)
    - P 1: CS 0023 32bit 0 (FFFFFFFF)
    - A 0: SS 002B 32bit 0 (FFFFFFFF)
    - Z 0: DS 002B 32bit 0 (FFFFFFFF)
    - S 0: FS 0053 32bit 7EFDD000 (FFF)
    - T 0: GS 002B 32bit 0 (FFFFFFFF)
    - D 0
    - O 0: LastErr 00000000 ERROR\_SUCCESS
    - EFL 00000206 (NO, NB, NE, A, NS, PE, GE, G)
    - ST0-ST6: empty 0.0
    - ST7: empty 0.0
  - Condition Code Register (C0): `Cond 0 0 0 1` (highlighted in red)
  - Err: 0 0 0 0 0 0
  - Mask: 1 1 1 1 1
  - Last cmd: `0023:00FC1006` d\_max.00FC1006
- Memory Dump:**
  - Address 0041FEF4: `0041FEF4 0041FEF4 1A`
  - Address 0041FEF8: `0041FEF8 0041FEF8 8A`
  - Address 0041FEFC: `0041FEFC 0041FEFC 8A`
  - Address 0041FF00: `0041FF00 0041FF00 8A`
  - Address 0041FF04: `0041FF04 0041FF04 8A`
  - Address 0041FF08: `0041FF08 0041FF08 8A`
  - Address 0041FF0C: `0041FF0C 0041FF0C 8A`
  - Address 0041FF10: `0041FF10 0041FF10 8A`
  - Address 0041FF14: `0041FF14 0041FF14 8A`
  - Address 0041FF18: `0041FF18 0041FF18 8A`
  - Address 0041FF1C: `0041FF1C 0041FF1C 8A`
  - Address 0041FF20: `0041FF20 0041FF20 8A`
  - Address 0041FF24: `0041FF24 0041FF24 8A`
  - Address 0041FF28: `0041FF28 0041FF28 8A`

Figure 1.74: OllyDbg: FCOMP executed

We see the state of the FPU's condition flags: all zeros except C0.

FNSTSW executed:

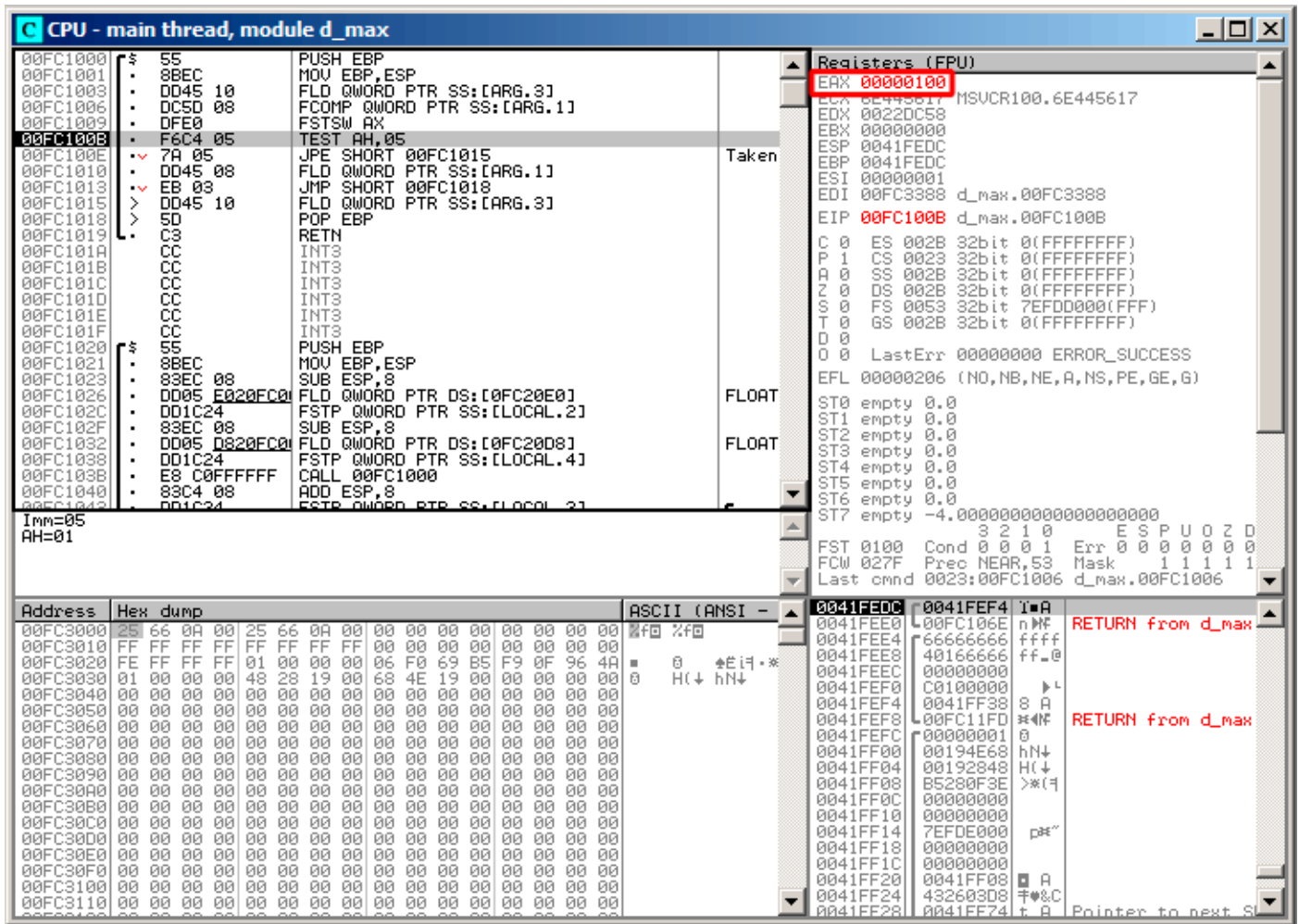

Figure 1.75: OllyDbg: FNSTSW executed

We see that the AX register contains 0x100: the C0 flag is at the 8th bit.

TEST executed:

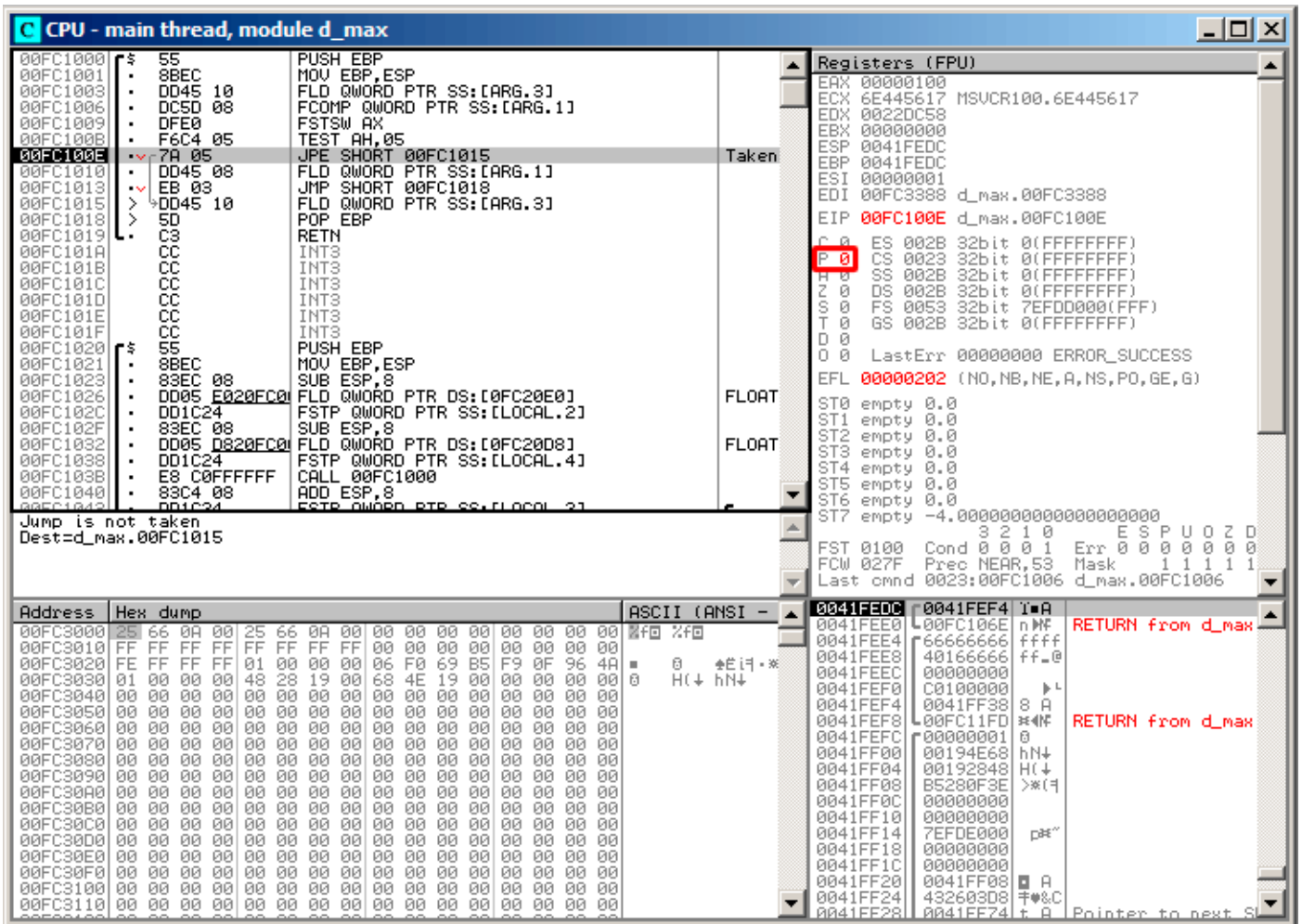

Figure 1.76: OllyDbg: TEST executed

The PF flag is cleared. Indeed:

the count of bits set in `0x100` is 1 and 1 is an odd number. `JPE` is being skipped now.

JPE hasn't been triggered, so FLD loads the value of *a* (5.6) in ST(0):

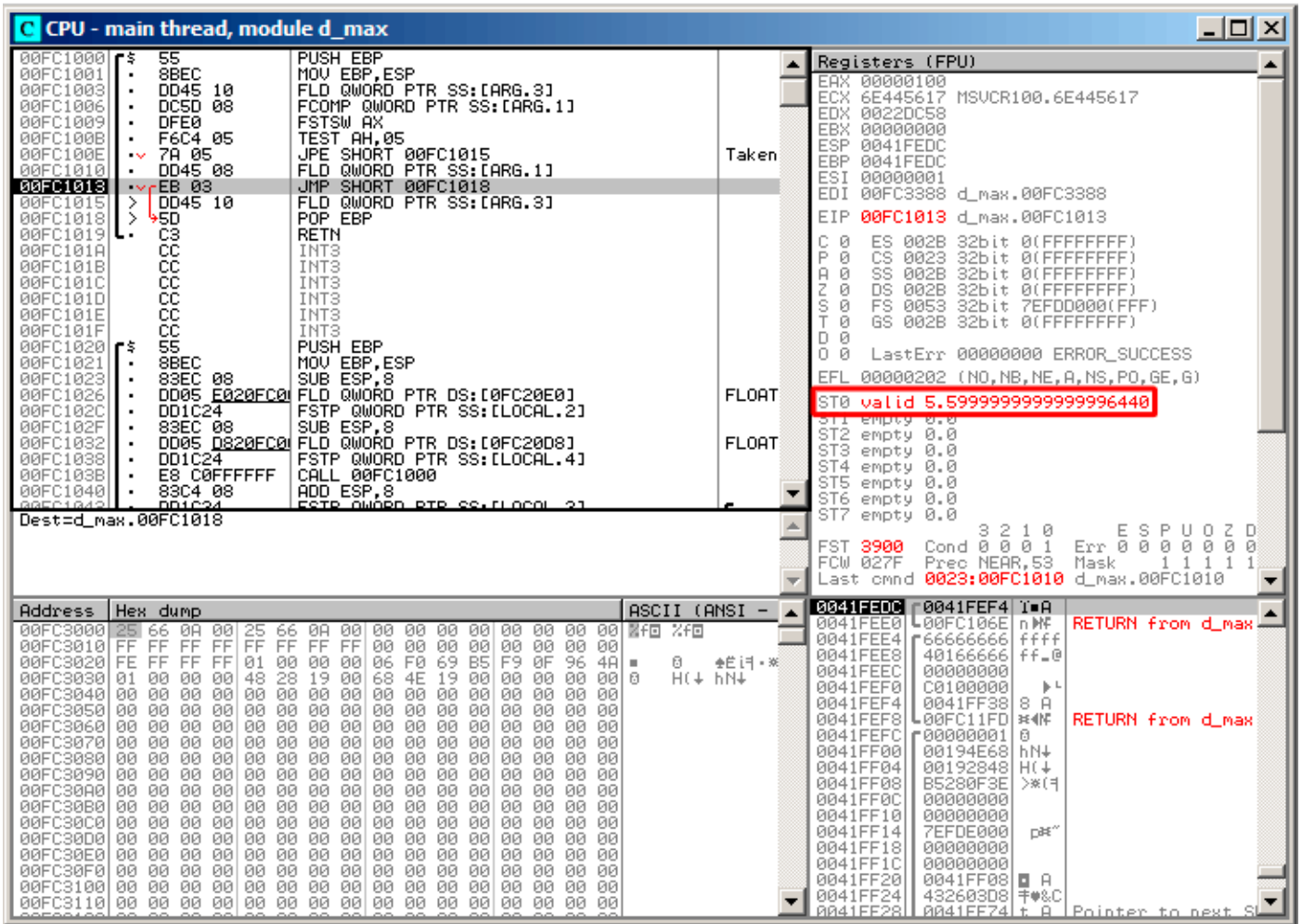

Figure 1.77: OllyDbg: second FLD executed

The function finishes its work.

## Optimizing MSVC 2010

Listing 1.215: Optimizing MSVC 2010

```

_a$ = 8           ; size = 8
_b$ = 16         ; size = 8
_d_max PROC
    fld     QWORD PTR _b$[esp-4]
    fld     QWORD PTR _a$[esp-4]

; current stack state: ST(0) = _a, ST(1) = _b

    fcom   ST(1) ; compare _a and ST(1) = (_b)
    fnstsw ax
    test   ah, 65 ; 00000041H
    jne    SHORT $LN5@d_max
; copy ST(0) to ST(1) and pop register,
; leave (_a) on top
    fstp   ST(1)

; current stack state: ST(0) = _a

    ret    0
$LN5@d_max:
; copy ST(0) to ST(0) and pop register,
; leave (_b) on top

```

```
    fstp    ST(0)
; current stack state: ST(0) = _b
    ret     0
_d_max    ENDP
```

F`COM` differs from F`COMP` in the sense that it just compares the values and doesn't change the FPU stack. Unlike the previous example, here the operands are in reverse order, which is why the result of the comparison in C3/C2/C0 is different:

- If  $a > b$  in our example, then C3/C2/C0 bits are to be set as: 0, 0, 0.
- If  $b > a$ , then the bits are: 0, 0, 1.
- If  $a = b$ , then the bits are: 1, 0, 0.

The test `ah, 65` instruction leaves just two bits —C3 and C0. Both will be zero if  $a > b$ : in that case the JNE jump will not be triggered. Then F`STP ST(1)` follows —this instruction copies the value from ST(0) to the operand and pops one value from the FPU stack. In other words, the instruction copies ST(0) (where the value of `_a` is now) into ST(1). After that, two copies of `_a` are at the top of the stack. Then, one value is popped. After that, ST(0) contains `_a` and the function is finished.

The conditional jump JNE is triggering in two cases: if  $b > a$  or  $a = b$ . ST(0) is copied into ST(0), it is just like an idle (NOP) operation, then one value is popped from the stack and the top of the stack (ST(0)) is contain what has been in ST(1) before (that is `_b`). Then the function finishes. The reason this instruction is used here probably is because the FPU has no other instruction to pop a value from the stack and discard it.

**First OllyDbg example: a=1.2 and b=3.4**

Both FLD are executed:

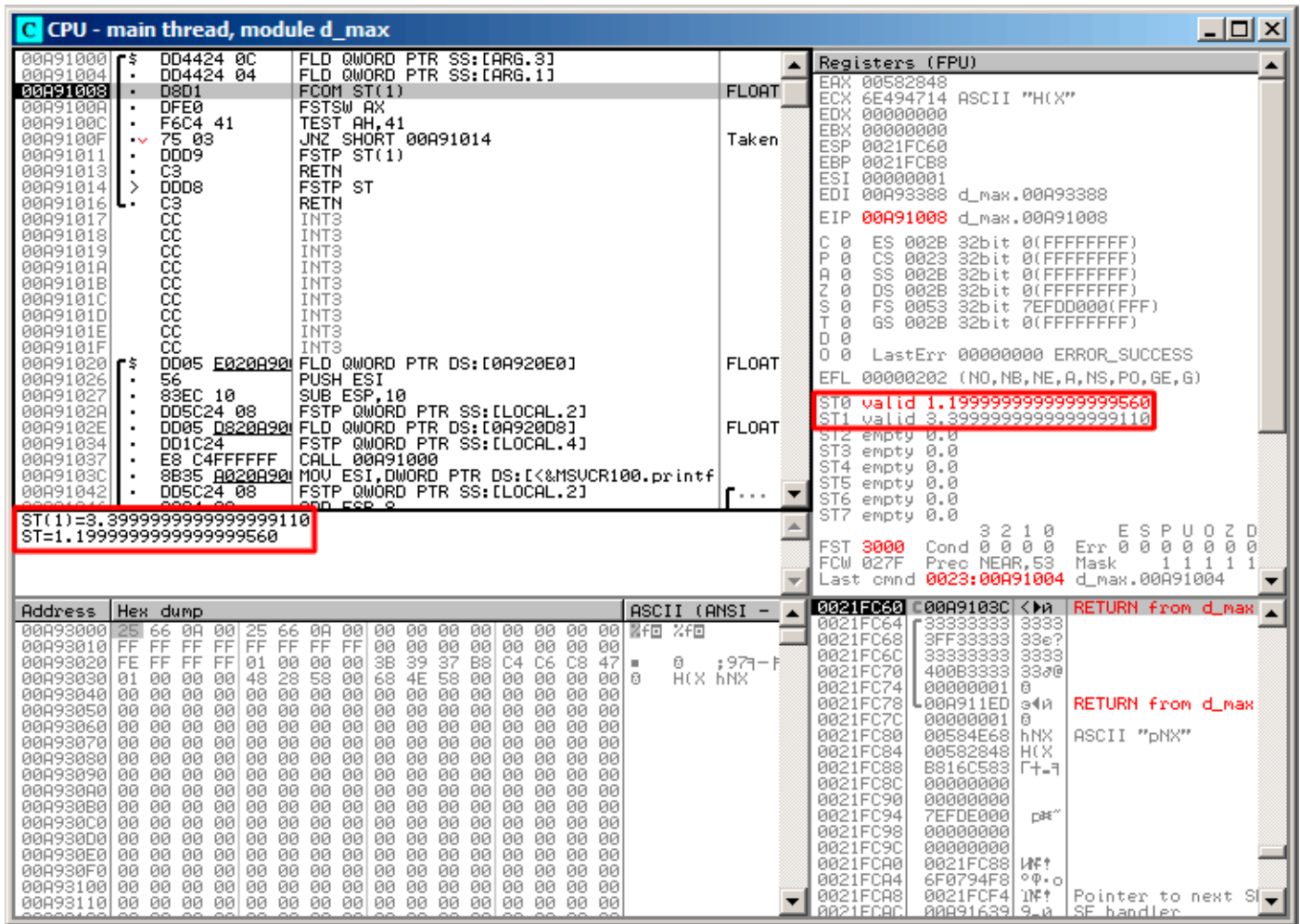

Figure 1.78: OllyDbg: both FLD are executed

FCOM being executed: OllyDbg shows the contents of ST(0) and ST(1) for convenience.

FCOM has been executed:

The screenshot displays the OllyDbg interface with the following components:

- Assembly View:** Shows instructions from address 00A91000 to 00A9104E. The instruction at 00A9100A is `FSTP AX`, which is highlighted. The status 'Taken' is visible next to it.
- Registers (FPU):** Shows the FPU register set. The `FST` register is highlighted with a value of `3100` (hex) and `Cond 0 0 0 1` (bits). The `FCW` register is `027F`.
- Hex Dump:** Shows memory addresses from 00A93000 to 00A93110. The hex dump at 00A93000 shows `25 66 0A 00 25 66 0A 00`, which corresponds to the instruction `FSTP AX`.
- Registers (GPR):** Shows the general purpose registers (EAX, ECX, EDI, etc.).

Figure 1.79: OllyDbg: FCOM has been executed

CF is set, all other condition flags are cleared.



FNSTSW has been executed, AX=0x3100:

**CPU - main thread, module d\_max**

Address	Hex dump	Assembly	Comment
00A91000	DD4424 0C	FLD QWORD PTR SS:[ARG.3]	
00A91004	DD4424 04	FLD QWORD PTR SS:[ARG.1]	
00A91008	08D1	FCOM ST(1)	
00A9100A	DFF0	FSTSW AX	
00A9100C	F6C4 41	TEST AH,41	
00A9100F	75 03	JNZ SHORT 00A91014	Taken
00A91011	DDD9	FSTP ST(1)	
00A91013	C3	RETN	
00A91014	DDD8	FSTP ST	
00A91016	C3	RETN	
00A91017	CC	INT3	
00A91018	CC	INT3	
00A91019	CC	INT3	
00A9101A	CC	INT3	
00A9101B	CC	INT3	
00A9101C	CC	INT3	
00A9101D	CC	INT3	
00A9101E	CC	INT3	
00A9101F	CC	INT3	
00A91020	DD05 0020A900	FLD QWORD PTR DS:[0A920E0]	FLOAT
00A91026	56	PUSH ESI	
00A91027	83EC 10	SUB ESP,10	
00A9102A	DD5C24 08	FSTP QWORD PTR SS:[LOCAL.2]	FLOAT
00A9102E	DD05 0820A900	FLD QWORD PTR DS:[0A920D8]	FLOAT
00A91034	DD1C24	FSTP QWORD PTR SS:[LOCAL.4]	FLOAT
00A91037	E8 C4FFFFFF	CALL 00A91000	
00A9103C	8B35 0020A900	MOV ESI,DWORD PTR DS:[&MSUCR100.printf	
00A91042	DD5C24 08	FSTP QWORD PTR SS:[LOCAL.2]	FLOAT
00A91046	83C4 08	ADD ESP,8	

Imm=41  
AH=31

**Registers (FPU)**

- EAX 00583100 ASCII "Administrator"
- ECX 8E494714 ASCII "HX"
- EDX 00000000
- EBX 00000000
- ESP 0021FC60
- EBP 0021FCB8
- ESI 00000001
- EDI 00A93388 d\_max.00A93388
- EIP 00A9100C d\_max.00A9100C
- C 0 ES 002B 32bit 0(FFFFFFFF)
- P 0 CS 0023 32bit 0(FFFFFFFF)
- A 0 SS 002B 32bit 0(FFFFFFFF)
- Z 0 DS 002B 32bit 0(FFFFFFFF)
- S 0 FS 0053 32bit 7EFDD000(FFF)
- T 0 GS 002B 32bit 0(FFFFFFFF)
- D 0
- O 0
- LastErr 00000000 ERROR\_SUCCESS
- EFL 00000202 (NO,NB,NE,A,NS,PO,GE,G)
- ST0 valid 1.1999999999999999560
- ST1 valid 3.3999999999999999110
- ST2 empty 0.0
- ST3 empty 0.0
- ST4 empty 0.0
- ST5 empty 0.0
- ST6 empty 0.0
- ST7 empty 0.0

**Memory Dump**

Address	Hex dump	ASCII (ANSI)
00A93000	26 66 0A 00 25 66 0A 00 00 00 00 00 00 00 00 00	%f %f
00A93010	FF FF FF FF FF FF FF FF 00 00 00 00 00 00 00 00	
00A93020	FE FF FF FF 01 00 00 00 3B 39 37 B8 C4 C6 C8 47	0 0 ;979-f
00A93030	01 00 00 00 48 28 58 00 68 4E 58 00 00 00 00 00	0 HX hNX
00A93040	00 00 00 00 00 00 00 00 00 00 00 00 00 00 00 00	
00A93050	00 00 00 00 00 00 00 00 00 00 00 00 00 00 00 00	
00A93060	00 00 00 00 00 00 00 00 00 00 00 00 00 00 00 00	
00A93070	00 00 00 00 00 00 00 00 00 00 00 00 00 00 00 00	
00A93080	00 00 00 00 00 00 00 00 00 00 00 00 00 00 00 00	
00A93090	00 00 00 00 00 00 00 00 00 00 00 00 00 00 00 00	
00A930A0	00 00 00 00 00 00 00 00 00 00 00 00 00 00 00 00	
00A930B0	00 00 00 00 00 00 00 00 00 00 00 00 00 00 00 00	
00A930C0	00 00 00 00 00 00 00 00 00 00 00 00 00 00 00 00	
00A930D0	00 00 00 00 00 00 00 00 00 00 00 00 00 00 00 00	
00A930E0	00 00 00 00 00 00 00 00 00 00 00 00 00 00 00 00	
00A930F0	00 00 00 00 00 00 00 00 00 00 00 00 00 00 00 00	
00A93100	00 00 00 00 00 00 00 00 00 00 00 00 00 00 00 00	
00A93110	00 00 00 00 00 00 00 00 00 00 00 00 00 00 00 00	

**Registers (FPU) (continued)**

- FST 3100 Cond 0 0 0 1 Err 0 0 0 0 0 0
- FCW 027F Prec NEAR,53 Mask 1 1 1 1 1
- Last cmd 0023:00A91008 d\_max.00A91008

**Memory Dump (continued)**

Address	Hex dump	ASCII (ANSI)
0021FC60	00A9103C	RETURN from d_max
0021FC64	33333333	3333
0021FC68	3FF33333	33e?
0021FC6C	33333333	3333
0021FC70	400B3333	33@e
0021FC74	00000001	0
0021FC78	00A911ED	e4n RETURN from d_max
0021FC7C	00000001	0
0021FC80	00534E68	hNX ASCII "pNX"
0021FC84	00532848	H(X
0021FC88	B816C583	Γ+-7
0021FC8C	00000000	
0021FC90	00000000	
0021FC94	7EFDE000	p#"
0021FC98	00000000	
0021FC9C	00000000	
0021FCA0	0021FC88	INF?
0021FCA4	6F0794F8	°Φ.°
0021FCA8	0021FCF4	INF? Pointer to next SI
0021FCAC	00A91639	9.3 SF handler

Figure 1.80: OllyDbg: FNSTSW is executed

TEST is executed:

The screenshot displays the OllyDbg interface with the following components:

- Assembly Window:** Shows assembly code for the main thread. The instruction at address 00A9100F is `JNZ SHORT 00A91014`, which is marked as "Taken". The instruction at 00A91010 is `FSTP ST(1)`. The instruction at 00A91014 is `FSTP ST`. The instruction at 00A91020 is `FLD QWORD PTR DS:[0A920E0]`, which is marked as "FLOAT". The instruction at 00A91022 is `FSTP QWORD PTR SS:[LOCAL.2]`, which is marked as "FLOAT".
- Registers (FPU) Window:** Shows the state of the FPU registers. The `ZF` register is highlighted in red and shows the value `0`. Other registers like `EAX`, `ECX`, `EDX`, etc., are also visible.
- Hex Dump Window:** Shows the hex dump of the assembly code. The instruction `JNZ SHORT 00A91014` is highlighted in red. The hex dump shows the bytes `75 03` for the instruction.

Figure 1.81: OllyDbg: TEST is executed

ZF=0, conditional jump is about to trigger now.

FSTP ST (or FSTP ST(0)) has been executed —1.2 has been popped from the stack, and 3.4 was left on top:

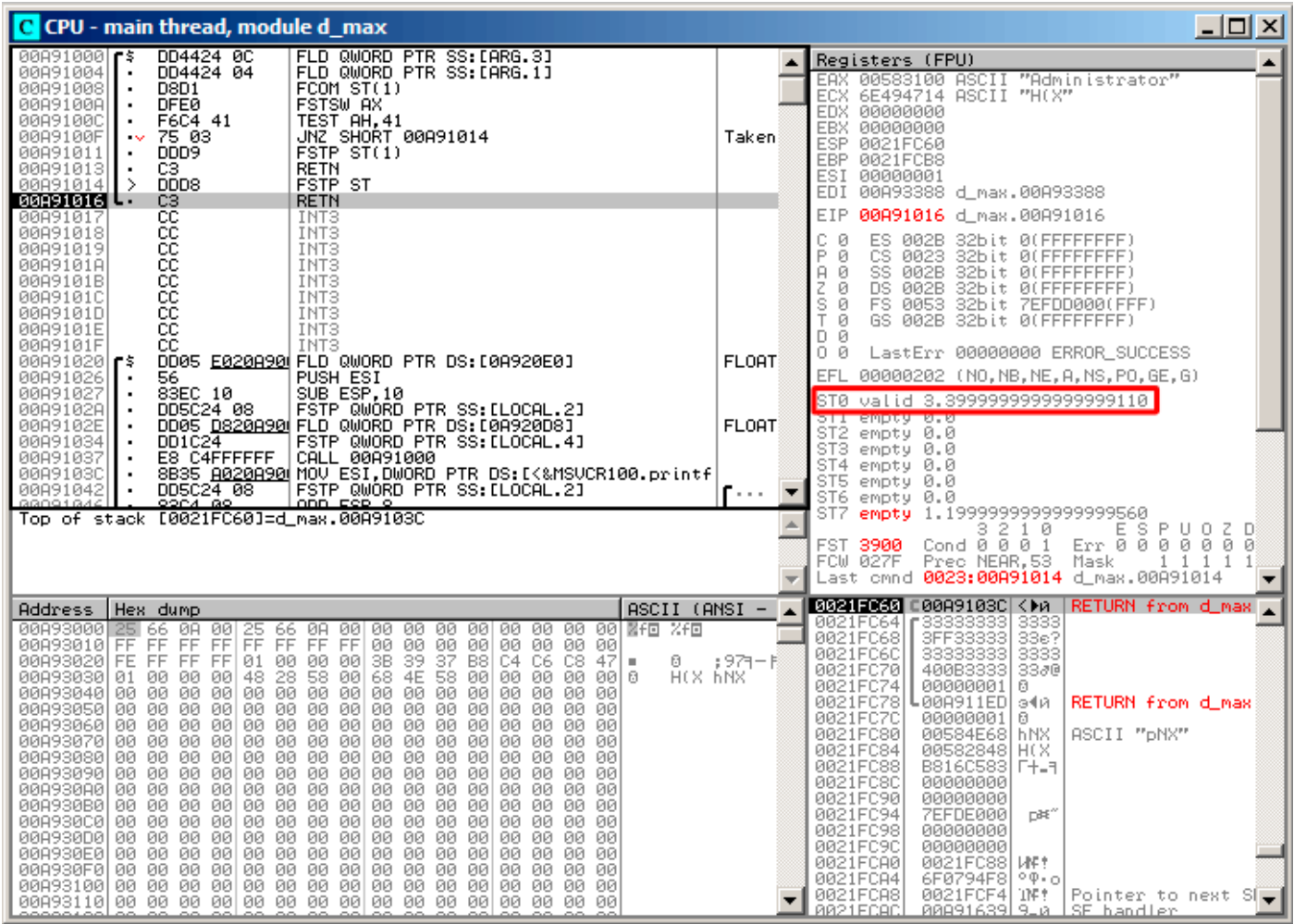

Figure 1.82: OlllyDbg: FSTP is executed

We see that the FSTP ST instruction works just like popping one value from the FPU stack.

## Second OllyDbg example: a=5.6 and b=-4

Both FLD are executed:

The screenshot shows the OllyDbg interface with the following details:

- Registers (FPU):** ST0 valid 5.5999999999999996440, ST1 valid -4.00000000000000000000. Other registers (ST2-ST7) are empty or 0.0.
- Disassembly:**
  - 00A91008: FLD QWORD PTR SS:[ARG.1] (Taken)
  - 00A91009: FCOM ST(1) (Taken)
  - 00A9100A: FSTSW AX
  - 00A9100B: TEST AH,41
  - 00A9100C: JNZ SHORT 00A91014
  - 00A9100D: FSTP ST(1)
  - 00A9100E: RETN
  - 00A9100F: FSTP ST
  - 00A91010: RETN
  - 00A91026: FLD QWORD PTR DS:[0A920E0] (Taken)
  - 00A91027: PUSH ESI
  - 00A91028: SUB ESP,10
  - 00A91029: FSTP QWORD PTR SS:[LOCAL.2]
  - 00A9102A: FLD QWORD PTR DS:[0A920D8] (Taken)
  - 00A9102B: FSTP QWORD PTR SS:[LOCAL.4]
  - 00A9102C: CALL 00A91000
  - 00A9102D: MOV ESI,DWORD PTR DS:[&MSUCR100.printf
  - 00A9102E: FSTP QWORD PTR SS:[LOCAL.2]
  - 00A9102F: ADD ESP,8
- Stack (ST):** ST(1)=-4.00000000000000000000, ST=5.5999999999999996440
- Registers (GPR):** EAX=00000009, ECX=6E445617, EDI=00A93388, EIP=00A91008.
- Control Flow:** FST 3100, FCW 027F, Last cmdnd 0023:00A91004.
- Disassembly (Bottom):** 0021FC60: 00A91069 i>> RETURN from d\_max

Figure 1.83: OllyDbg: both FLD are executed

FCOM is about to execute.

FCOM has been executed:

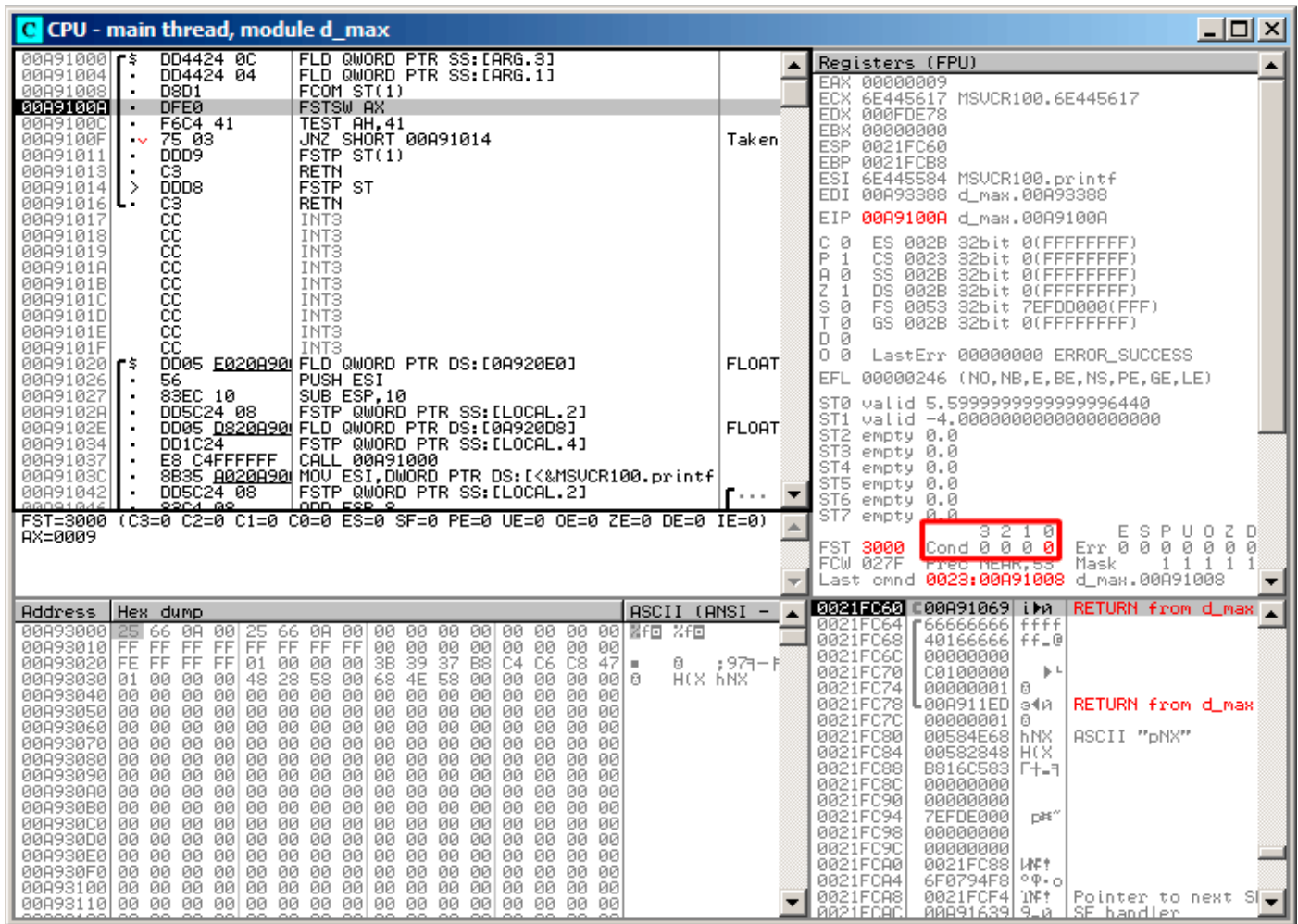

Figure 1.84: OllyDbg: FCOM is finished

All conditional flags are cleared.

FNSTSW done, AX=0x3000:

The screenshot displays the OllYDbg interface with the following details:

- Registers (FPU):** EAX is 00003000. Other registers include ECX (6E445517), EDX (000FDE78), EBX (00000000), ESP (0021FC60), EBP (0021FCB8), ESI (6E445584), EDI (00A93388), and EIP (00A9100C).
- Assembly Code:**
  - 00A91000: FLD QWORD PTR SS:[ARG.3]
  - 00A91004: FLD QWORD PTR SS:[ARG.1]
  - 00A91008: FCOM ST(1)
  - 00A9100C: FSTSW AX
  - 00A9100E: TEST AH,41
  - 00A91010: JNZ SHORT 00A91014
  - 00A91012: FSTP ST(1)
  - 00A91014: RETN
  - 00A91016: CC
  - 00A91018: INT3
  - 00A9101A: INT3
  - 00A9101C: INT3
  - 00A9101E: INT3
  - 00A91020: FLD QWORD PTR DS:[0A920E0]
  - 00A91022: PUSH ESI
  - 00A91024: SUB ESP,10
  - 00A91026: FSTP QWORD PTR SS:[LOCAL.2]
  - 00A91028: FLD QWORD PTR DS:[0A920D8]
  - 00A9102A: FSTP QWORD PTR SS:[LOCAL.4]
  - 00A9102C: CALL 00A91000
  - 00A9102E: MOV ESI,DWORD PTR DS:[&MSUCR100.printf]
  - 00A91030: FSTP QWORD PTR SS:[LOCAL.2]
  - 00A91032: ADD ESP,8
- Disassembly:** Shows instructions like FLD, FCOM, FSTP, CALL, MOV, and ADD with their respective operands.
- Hex dump:** Shows memory addresses from 00A93000 to 00A93110 with corresponding hex values and ASCII representations.
- Registers (CPU):** Shows FPU control words (FST, FCW, Last cmd) and status flags (C, P, A, Z, S, T, D, O).

Figure 1.85: OllYDbg: FNSTSW has been executed

TEST has been executed:

The screenshot shows the OllyDbg interface with the following components:

- Assembly Window:** Shows assembly instructions. The instruction at address 00A9100F is `JNZ SHORT 00A91014`, which is marked as "Taken".
- Registers (FPU) Window:** Shows the state of various registers. The `ZF` flag is highlighted with a red box and set to `1`. Other registers like `EAX`, `ECX`, `ESI`, and `EIP` are also visible.
- Memory Dump:** Shows a hex dump of memory starting at address 00A93000. The dump contains various hexadecimal values and some ASCII characters.
- Registers (Integer) Window:** Shows the state of integer registers. The `ZF` flag is also visible here, set to `1`.

Figure 1.86: OllyDbg: TEST has been executed

ZF=1, jump will not happen now.

FSTP ST(1) has been executed: a value of 5.6 is now at the top of the FPU stack.

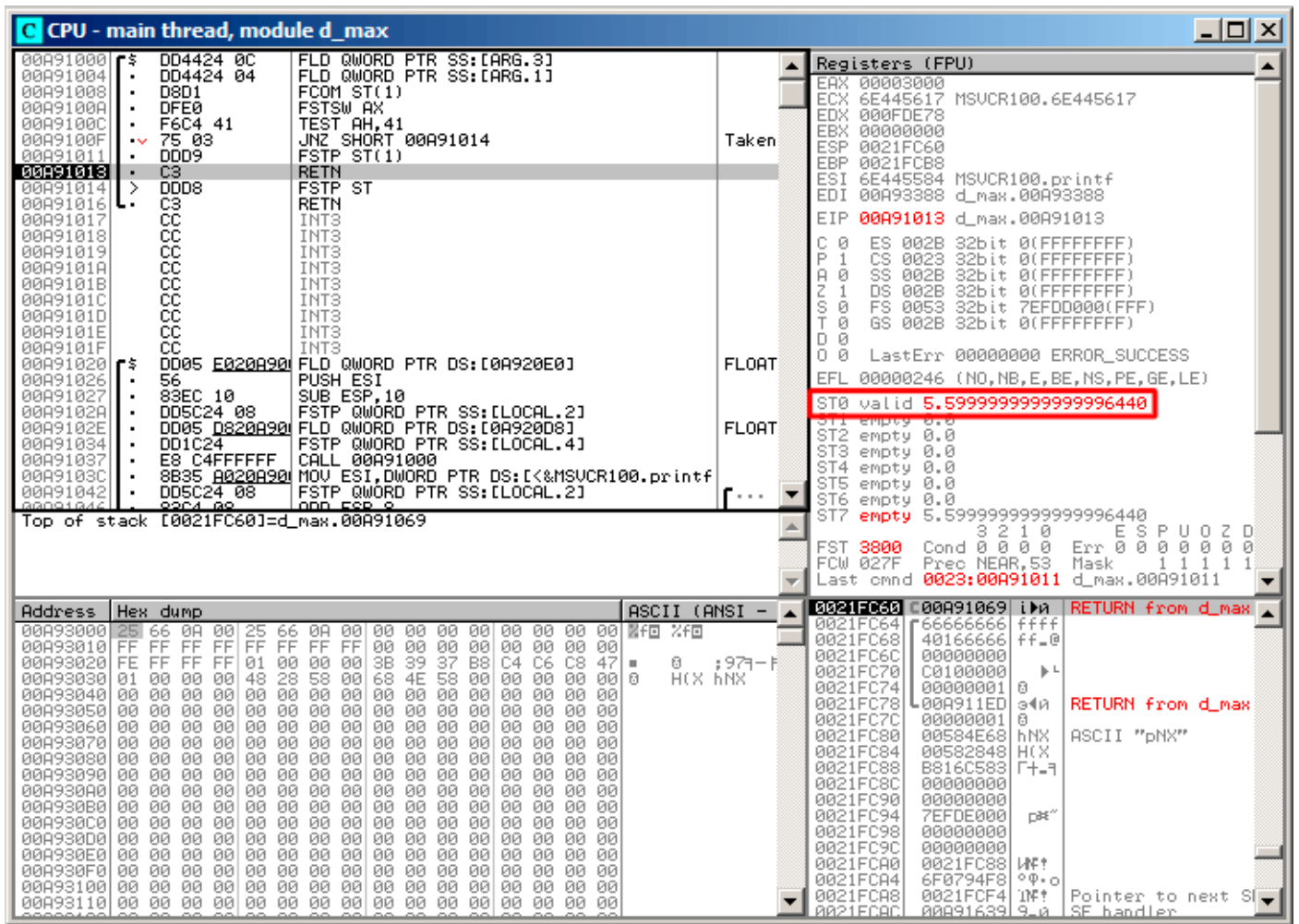

Figure 1.87: OllyDbg: FSTP has been executed

We now see that the FSTP ST(1) instruction works as follows: it leaves what has been at the top of the stack, but clears ST(1).

### GCC 4.4.1

Listing 1.216: GCC 4.4.1

```
d_max proc near
b          = qword ptr -10h
a          = qword ptr -8
a_first_half = dword ptr 8
a_second_half = dword ptr 0Ch
b_first_half = dword ptr 10h
b_second_half = dword ptr 14h

    push    ebp
    mov     ebp, esp
    sub     esp, 10h

; put a and b to local stack:

    mov     eax, [ebp+a_first_half]
    mov     dword ptr [ebp+a], eax
    mov     eax, [ebp+a_second_half]
    mov     dword ptr [ebp+a+4], eax
    mov     eax, [ebp+b_first_half]
    mov     dword ptr [ebp+b], eax
```



```

mov    eax, [ebp+b_second_half]
mov    dword ptr [ebp+b+4], eax

; load a and b to FPU stack:

fld    [ebp+a]
fld    [ebp+b]

; current stack state: ST(0) - b; ST(1) - a

fxch   st(1) ; this instruction swaps ST(1) and ST(0)

; current stack state: ST(0) - a; ST(1) - b

fucompp    ; compare a and b and pop two values from stack, i.e., a and b
fnstsw    ax ; store FPU status to AX
sahf      ; load SF, ZF, AF, PF, and CF flags state from AH
setnbe   al ; store 1 to AL, if CF=0 and ZF=0
test     al, al ; AL==0 ?
jz       short loc_8048453 ; yes
fld      [ebp+a]
jmp      short locret_8048456

loc_8048453:
fld      [ebp+b]

locret_8048456:
leave
retn
d_max endp

```

FUCOMPP is almost like FCOM, but pops both values from the stack and handles “not-a-numbers” differently. A bit about *not-a-numbers*.

The FPU is able to deal with special values which are *not-a-numbers* or NaNs. These are infinity, result of division by 0, etc. Not-a-numbers can be “quiet” and “signaling”. It is possible to continue to work with “quiet” NaNs, but if one tries to do any operation with “signaling” NaNs, an exception is to be raised.

FCOM raises an exception if any operand is NaN. FUCOM raises an exception only if any operand is a signaling NaN (SNaN).

The next instruction is SAHF (*Store AH into Flags*) —this is a rare instruction in code not related to the FPU. 8 bits from AH are moved into the lower 8 bits of the CPU flags in the following order:

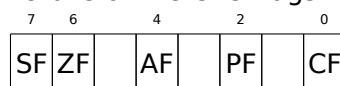

Let’s recall that FNSTSW moves the bits that interest us (C3/C2/C0) into AH and they are in positions 6, 2, 0 of the AH register:

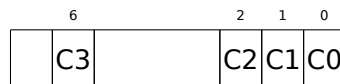

In other words, the fnstsw ax / sahf instruction pair moves C3/C2/C0 into ZF, PF and CF.

Now let’s also recall the values of C3/C2/C0 in different conditions:

- If  $a$  is greater than  $b$  in our example, then C3/C2/C0 are to be set to: 0, 0, 0.
- if  $a$  is less than  $b$ , then the bits are to be set to: 0, 0, 1.
- If  $a = b$ , then: 1, 0, 0.

In other words, these states of the CPU flags are possible after three FUCOMPP/FNSTSW/SAHF instructions:

- If  $a > b$ , the CPU flags are to be set as: ZF=0, PF=0, CF=0.
- If  $a < b$ , then the flags are to be set as: ZF=0, PF=0, CF=1.
- And if  $a = b$ , then: ZF=1, PF=0, CF=0.

Depending on the CPU flags and conditions, SETNBE stores 1 or 0 to AL. It is almost the counterpart of JNBE, with the exception that SETcc<sup>115</sup> stores 1 or 0 in AL, but Jcc does actually jump or not. SETNBE stores 1 only if CF=0 and ZF=0. If it is not true, 0 is to be stored into AL.

Only in one case both CF and ZF are 0: if  $a > b$ .

Then 1 is to be stored to AL, the subsequent JZ is not to be triggered and the function will return `_a`. In all other cases, `_b` is to be returned.

### Optimizing GCC 4.4.1

Listing 1.217: Optimizing GCC 4.4.1

```

d_max      public d_max
           proc near

arg_0      = qword ptr 8
arg_8      = qword ptr 10h

           push    ebp
           mov     ebp, esp
           fld     [ebp+arg_0] ; _a
           fld     [ebp+arg_8] ; _b

; stack state now: ST(0) = _b, ST(1) = _a
           fxch   st(1)

; stack state now: ST(0) = _a, ST(1) = _b
           fucom  st(1) ; compare _a and _b
           fnstsw ax
           sahf
           ja     short loc_8048448

; store ST(0) to ST(0) (idle operation),
; pop value at top of stack,
; leave _b at top
           fstp   st
           jmp    short loc_804844A

loc_8048448:
; store _a to ST(1), pop value at top of stack, leave _a at top
           fstp   st(1)

loc_804844A:
           pop    ebp
           retn
d_max      endp

```

It is almost the same except that `s` used after SAHF. Actually, conditional jump instructions that check “larger”, “lesser” or “equal” for unsigned number comparison (these are JA, JAE, JB, JBE, JE/JZ, JNA, JNAE, JNB, JNBE, JNE/JNZ) check only flags CF and ZF.

Let’s recall where bits C3/C2/C0 are located in the AH register after the execution of FSTSW/FNSTSW:

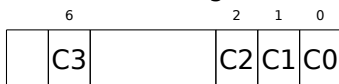

Let’s also recall, how the bits from AH are stored into the CPU flags after the execution of SAHF:

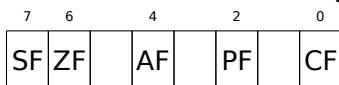

After the comparison, the C3 and C0 bits are moved into ZF and CF, so the conditional jumps are able work after. `s` triggering if both CF are ZF zero.

Thereby, the conditional jumps instructions listed here can be used after a FNSTSW/SAHF instruction pair.

<sup>115</sup>cc is condition code

Apparently, the FPU C3/C2/C0 status bits were placed there intentionally, to easily map them to base CPU flags without additional permutations?

### GCC 4.8.1 with -O3 optimization turned on

Some new FPU instructions were added in the P6 Intel family<sup>116</sup>. These are FUCOMI (compare operands and set flags of the main CPU) and FCMOVcc (works like CMOVcc, but on FPU registers).

Apparently, the maintainers of GCC decided to drop support of pre-P6 Intel CPUs (early Pentiums, 80486, etc.).

And also, the FPU is no longer separate unit in P6 Intel family, so now it is possible to modify/check flags of the main CPU from the FPU.

So what we get is:

Listing 1.218: Optimizing GCC 4.8.1

```
fld    QWORD PTR [esp+4]    ; load "a"
fld    QWORD PTR [esp+12]   ; load "b"
; ST0=b, ST1=a
fxch   st(1)
; ST0=a, ST1=b
; compare "a" and "b"
fucomi st, st(1)
; copy ST1 ("b" here) to ST0 if a<=b
; leave "a" in ST0 otherwise
fcmovbe st, st(1)
; discard value in ST1
fstp   st(1)
ret
```

Hard to guess why FXCH (swap operands) is here.

It's possible to get rid of it easily by swapping the first two FLD instructions or by replacing FCMOVBE (*below or equal*) by FCMOVA (*above*). Probably it's a compiler inaccuracy.

So FUCOMI compares ST(0) (*a*) and ST(1) (*b*) and then sets some flags in the main CPU. FCMOVBE checks the flags and copies ST(1) (*b* here at the moment) to ST(0) (*a* here) if  $ST0(a) \leq ST1(b)$ . Otherwise ( $a > b$ ), it leaves *a* in ST(0).

The last FSTP leaves ST(0) on top of the stack, discarding the contents of ST(1).

Let's trace this function in GDB:

Listing 1.219: Optimizing GCC 4.8.1 and GDB

```
1 dennis@ubuntuvms:~/polygon$ gcc -O3 d_max.c -o d_max -fno-inline
2 dennis@ubuntuvms:~/polygon$ gdb d_max
3 GNU gdb (GDB) 7.6.1-ubuntu
4 ...
5 Reading symbols from /home/dennis/polygon/d_max...(no debugging symbols found)...done.
6 (gdb) b d_max
7 Breakpoint 1 at 0x80484a0
8 (gdb) run
9 Starting program: /home/dennis/polygon/d_max
10
11 Breakpoint 1, 0x080484a0 in d_max ()
12 (gdb) ni
13 0x080484a4 in d_max ()
14 (gdb) disas $eip
15 Dump of assembler code for function d_max:
16   0x080484a0 <+0>:   fldl   0x4(%esp)
17 => 0x080484a4 <+4>:   fldl   0xc(%esp)
18   0x080484a8 <+8>:   fxch   %st(1)
19   0x080484aa <+10>:  fucomi %st(1),%st
20   0x080484ac <+12>:  fcmovbe %st(1),%st
21   0x080484ae <+14>:  fstp   %st(1)
22   0x080484b0 <+16>:  ret
23 End of assembler dump.
```

<sup>116</sup>Starting at Pentium Pro, Pentium-II, etc.

```

24 (gdb) ni
25 0x080484a8 in d_max ()
26 (gdb) info float
27   R7: Valid   0x3fff999999999999800 +1.19999999999999956
28 =>R6: Valid   0x4000d9999999999999800 +3.39999999999999911
29   R5: Empty   0x000000000000000000000
30   R4: Empty   0x000000000000000000000
31   R3: Empty   0x000000000000000000000
32   R2: Empty   0x000000000000000000000
33   R1: Empty   0x000000000000000000000
34   R0: Empty   0x000000000000000000000
35
36 Status Word:      0x3000
37                   TOP: 6
38 Control Word:     0x037f  IM DM ZM OM UM PM
39                   PC: Extended Precision (64-bits)
40                   RC: Round to nearest
41 Tag Word:         0x0fff
42 Instruction Pointer: 0x73:0x080484a4
43 Operand Pointer:   0x7b:0xbffff118
44 Opcode:           0x0000
45 (gdb) ni
46 0x080484aa in d_max ()
47 (gdb) info float
48   R7: Valid   0x4000d9999999999999800 +3.39999999999999911
49 =>R6: Valid   0x3fff99999999999999800 +1.19999999999999956
50   R5: Empty   0x000000000000000000000
51   R4: Empty   0x000000000000000000000
52   R3: Empty   0x000000000000000000000
53   R2: Empty   0x000000000000000000000
54   R1: Empty   0x000000000000000000000
55   R0: Empty   0x000000000000000000000
56
57 Status Word:      0x3000
58                   TOP: 6
59 Control Word:     0x037f  IM DM ZM OM UM PM
60                   PC: Extended Precision (64-bits)
61                   RC: Round to nearest
62 Tag Word:         0x0fff
63 Instruction Pointer: 0x73:0x080484a8
64 Operand Pointer:   0x7b:0xbffff118
65 Opcode:           0x0000
66 (gdb) disas $eip
67 Dump of assembler code for function d_max:
68   0x080484a0 <+0>:   fldl   0x4(%esp)
69   0x080484a4 <+4>:   fldl   0xc(%esp)
70   0x080484a8 <+8>:   fxch   %st(1)
71 => 0x080484aa <+10>: fucomi %st(1),%st
72   0x080484ac <+12>: fcmovbe %st(1),%st
73   0x080484ae <+14>: fstp   %st(1)
74   0x080484b0 <+16>: ret
75 End of assembler dump.
76 (gdb) ni
77 0x080484ac in d_max ()
78 (gdb) info registers
79 eax                0x1          1
80 ecx                0xbffff1c4       -1073745468
81 edx                0x8048340       134513472
82 ebx                0xb7fbf000       -1208225792
83 esp                0xbffff10c       0xbffff10c
84 ebp                0xbffff128       0xbffff128
85 esi                0x0          0
86 edi                0x0          0
87 eip                0x80484ac       0x80484ac <d_max+12>
88 eflags             0x203       [ CF IF ]
89 cs                 0x73          115
90 ss                 0x7b          123
91 ds                 0x7b          123
92 es                 0x7b          123
93 fs                 0x0          0

```

```

94 gs                0x33      51
95 (gdb) ni
96 0x080484ae in d_max ()
97 (gdb) info float
98   R7: Valid      0x4000d99999999999800 +3.39999999999999911
99 =>R6: Valid      0x4000d99999999999800 +3.39999999999999911
100  R5: Empty      0x00000000000000000000000000000000
101  R4: Empty      0x00000000000000000000000000000000
102  R3: Empty      0x00000000000000000000000000000000
103  R2: Empty      0x00000000000000000000000000000000
104  R1: Empty      0x00000000000000000000000000000000
105  R0: Empty      0x00000000000000000000000000000000
106
107 Status Word:      0x3000
108                   TOP: 6
109 Control Word:     0x037f  IM DM ZM OM UM PM
110                   PC: Extended Precision (64-bits)
111                   RC: Round to nearest
112 Tag Word:         0x0fff
113 Instruction Pointer: 0x73:0x080484ac
114 Operand Pointer:   0x7b:0xbffff118
115 Opcode:           0x0000
116 (gdb) disas $eip
117 Dump of assembler code for function d_max:
118   0x080484a0 <+0>:   fldl   0x4(%esp)
119   0x080484a4 <+4>:   fldl   0xc(%esp)
120   0x080484a8 <+8>:   fxch  %st(1)
121   0x080484aa <+10>: fucomi %st(1),%st
122   0x080484ac <+12>: fcmovbe %st(1),%st
123 => 0x080484ae <+14>: fstp  %st(1)
124   0x080484b0 <+16>: ret
125 End of assembler dump.
126 (gdb) ni
127 0x080484b0 in d_max ()
128 (gdb) info float
129 =>R7: Valid      0x4000d99999999999800 +3.39999999999999911
130  R6: Empty      0x4000d99999999999800
131  R5: Empty      0x00000000000000000000000000000000
132  R4: Empty      0x00000000000000000000000000000000
133  R3: Empty      0x00000000000000000000000000000000
134  R2: Empty      0x00000000000000000000000000000000
135  R1: Empty      0x00000000000000000000000000000000
136  R0: Empty      0x00000000000000000000000000000000
137
138 Status Word:      0x3800
139                   TOP: 7
140 Control Word:     0x037f  IM DM ZM OM UM PM
141                   PC: Extended Precision (64-bits)
142                   RC: Round to nearest
143 Tag Word:         0x3fff
144 Instruction Pointer: 0x73:0x080484ae
145 Operand Pointer:   0x7b:0xbffff118
146 Opcode:           0x0000
147 (gdb) quit
148 A debugging session is active.
149
150       Inferior 1 [process 30194] will be killed.
151
152 Quit anyway? (y or n) y
153 dennis@ubuntuv:~/polygon$

```

Using “ni”, let’s execute the first two FLD instructions.

Let’s examine the FPU registers (line 33).

As it was mentioned before, the FPU registers set is a circular buffer rather than a stack ( [1.25.5 on page 225](#)). And GDB doesn’t show STx registers, but internal the FPU registers (Rx). The arrow (at line 35) points to the current top of the stack.

You can also see the TOP register contents in *Status Word* (line 36-37)—it is 6 now, so the stack top is now

pointing to internal register 6.

The values of *a* and *b* are swapped after FXCH is executed (line 54).

FUCOMI is executed (line 83). Let's see the flags: CF is set (line 95).

FCMOVBE has copied the value of *b* (see line 104).

FSTP leaves one value at the top of stack (line 139). The value of TOP is now 7, so the FPU stack top is pointing to internal register 7.

## ARM

### Optimizing Xcode 4.6.3 (LLVM) (ARM mode)

Listing 1.220: Optimizing Xcode 4.6.3 (LLVM) (ARM mode)

VMOV	D16, R2, R3 ; b
VMOV	D17, R0, R1 ; a
VCMPE.F64	D17, D16
VMRS	APSR_nzcv, FPSCR
VMOVGT.F64	D16, D17 ; copy "a" to D16
VMOV	R0, R1, D16
BX	LR

A very simple case. The input values are placed into the D17 and D16 registers and then compared using the VCMPE instruction.

Just like in the x86 coprocessor, the ARM coprocessor has its own status and flags register ([FPSCR<sup>117</sup>](#)), since there is a necessity to store coprocessor-specific flags. And just like in x86, there are no conditional jump instruction in ARM, that can check bits in the status register of the coprocessor. So there is VMRS, which copies 4 bits (N, Z, C, V) from the coprocessor status word into bits of the *general* status register ([APSR<sup>118</sup>](#)).

VMOVGT is the analog of the MOVGT, instruction for D-registers, it executes if one operand is greater than the other while comparing (*GT—Greater Than*).

If it gets executed, the value of *a* is to be written into D16 (that is currently stored in D17). Otherwise the value of *b* stays in the D16 register.

The penultimate instruction VMOV prepares the value in the D16 register for returning it via the R0 and R1 register pair.

### Optimizing Xcode 4.6.3 (LLVM) (Thumb-2 mode)

Listing 1.221: Optimizing Xcode 4.6.3 (LLVM) (Thumb-2 mode)

VMOV	D16, R2, R3 ; b
VMOV	D17, R0, R1 ; a
VCMPE.F64	D17, D16
VMRS	APSR_nzcv, FPSCR
IT GT	
VMOVGT.F64	D16, D17
VMOV	R0, R1, D16
BX	LR

Almost the same as in the previous example, however slightly different. As we already know, many instructions in ARM mode can be supplemented by condition predicate. But there is no such thing in Thumb mode. There is no space in the 16-bit instructions for 4 more bits in which conditions can be encoded.

However, Thumb-2 was extended to make it possible to specify predicates to old Thumb instructions. Here, in the [IDA](#)-generated listing, we see the VMOVGT instruction, as in previous example.

In fact, the usual VMOV is encoded there, but [IDA](#) adds the -GT suffix to it, since there is a IT GT instruction placed right before it.

<sup>117</sup>(ARM) Floating-Point Status and Control Register

<sup>118</sup>(ARM) Application Program Status Register

The IT instruction defines a so-called *if-then block*.

After the instruction it is possible to place up to 4 instructions, each of them has a predicate suffix. In our example, IT GT implies that the next instruction is to be executed, if the *GT (Greater Than)* condition is true.

Here is a more complex code fragment, by the way, from Angry Birds (for iOS):

Listing 1.222: Angry Birds Classic

```
...
ITE NE
VMOVNE      R2, R3, D16
VMOVEQ      R2, R3, D17
BLX         _objc_msgSend ; not suffixed
...
```

ITE stands for *if-then-else*

and it encodes suffixes for the next two instructions.

The first instruction executes if the condition encoded in ITE (*NE, not equal*) is true at, and the second—if the condition is not true. (The inverse condition of NE is EQ (*equal*)).

The instruction followed after the second VMOV (or VMOVEQ) is a normal one, not suffixed (BLX).

One more that's slightly harder, which is also from Angry Birds:

Listing 1.223: Angry Birds Classic

```
...
ITTTT EQ
MOVEQ       R0, R4
ADDEQ       SP, SP, #0x20
POPEQ.W     {R8,R10}
POPEQ       {R4-R7,PC}
BLX         __stack_chk_fail ; not suffixed
...
```

Four "T" symbols in the instruction mnemonic mean that the four subsequent instructions are to be executed if the condition is true.

That's why [IDA](#) adds the -EQ suffix to each one of them.

And if there was, for example, ITEEE EQ (*if-then-else-else-else*), then the suffixes would have been set as follows:

```
-EQ
-NE
-NE
-NE
```

Another fragment from Angry Birds:

Listing 1.224: Angry Birds Classic

```
...
CMP.W       R0, #0xFFFFFFFF
ITTE LE
SUBLE.W     R10, R0, #1
NEGLE      R0, R0
MOVGT      R10, R0
MOVS       R6, #0 ; not suffixed
CBZ        R0, loc_1E7E32 ; not suffixed
...
```

### ITTE (*if-then-then-else*)

implies that the 1st and 2nd instructions are to be executed if the LE (*Less or Equal*) condition is true, and the 3rd—if the inverse condition (GT—*Greater Than*) is true.

Compilers usually don't generate all possible combinations.

For example, in the mentioned Angry Birds game (*classic* version for iOS) only these variants of the IT instruction are used: IT, ITE, ITT, ITTE, ITTT, ITTTT. How to learn this? In IDA, it is possible to produce listing files, so it was created with an option to show 4 bytes for each opcode. Then, knowing the high part of the 16-bit opcode (IT is 0xBF), we do the following using grep:

```
cat AngryBirdsClassic.lst | grep " BF" | grep "IT" > results.lst
```

By the way, if you program in ARM assembly language manually for Thumb-2 mode, and you add conditional suffixes, the assembler will add the IT instructions automatically with the required flags where it is necessary.

### Non-optimizing Xcode 4.6.3 (LLVM) (ARM mode)

Listing 1.225: Non-optimizing Xcode 4.6.3 (LLVM) (ARM mode)

```
b          = -0x20
a          = -0x18
val_to_return = -0x10
saved_R7   = -4

        STR        R7, [SP,#saved_R7]!
        MOV        R7, SP
        SUB        SP, SP, #0x1C
        BIC        SP, SP, #7
        VMOV       D16, R2, R3
        VMOV       D17, R0, R1
        VSTR       D17, [SP,#0x20+a]
        VSTR       D16, [SP,#0x20+b]
        VLDR       D16, [SP,#0x20+a]
        VLDR       D17, [SP,#0x20+b]
        VCMPE.F64  D16, D17
        VMRS       APSR_nzcv, FPSCR
        BLE        loc_2E08
        VLDR       D16, [SP,#0x20+a]
        VSTR       D16, [SP,#0x20+val_to_return]
        B          loc_2E10

loc_2E08
        VLDR       D16, [SP,#0x20+b]
        VSTR       D16, [SP,#0x20+val_to_return]

loc_2E10
        VLDR       D16, [SP,#0x20+val_to_return]
        VMOV       R0, R1, D16
        MOV        SP, R7
        LDR        R7, [SP+0x20+b], #4
        BX        LR
```

Almost the same as we already saw, but there is too much redundant code because the *a* and *b* variables are stored in the local stack, as well as the return value.

### Optimizing Keil 6/2013 (Thumb mode)

Listing 1.226: Optimizing Keil 6/2013 (Thumb mode)

```
PUSH    {R3-R7,LR}
```



```

        MOVS    R4, R2
        MOVS    R5, R3
        MOVS    R6, R0
        MOVS    R7, R1
        BL     __aeabi_cdrcmple
        BCS    loc_1C0
        MOVS    R0, R6
        MOVS    R1, R7
        POP     {R3-R7,PC}

loc_1C0
        MOVS    R0, R4
        MOVS    R1, R5
        POP     {R3-R7,PC}

```

Keil doesn't generate FPU-instructions since it cannot rely on them being supported on the target CPU, and it cannot be done by straightforward bitwise comparing. So it calls an external library function to do the comparison: `__aeabi_cdrcmple`.

N.B. The result of the comparison is to be left in the flags by this function, so the following BCS (*Carry set—Greater than or equal*) instruction can work without any additional code.

## ARM64

### Optimizing GCC (Linaro) 4.9

```

d_max:
; D0 - a, D1 - b
    fcmpe    d0, d1
    fcsel    d0, d0, d1, gt
; now result in D0
    ret

```

The ARM64 ISA has FPU-instructions which set `APSR` the CPU flags instead of `FPSCR` for convenience. The FPU is not a separate device here anymore (at least, logically). Here we see `FCMPE`. It compares the two values passed in `D0` and `D1` (which are the first and second arguments of the function) and sets `APSR` flags (N, Z, C, V).

`FCSEL` (*Floating Conditional Select*) copies the value of `D0` or `D1` into `D0` depending on the condition (GT—Greater Than), and again, it uses flags in `APSR` register instead of `FPSCR`.

This is much more convenient, compared to the instruction set in older CPUs.

If the condition is true (GT), then the value of `D0` is copied into `D0` (i.e., nothing happens). If the condition is not true, the value of `D1` is copied into `D0`.

### Non-optimizing GCC (Linaro) 4.9

```

d_max:
; save input arguments in "Register Save Area"
    sub     sp, sp, #16
    str     d0, [sp,8]
    str     d1, [sp]
; reload values
    ldr     x1, [sp,8]
    ldr     x0, [sp]
    fmov    d0, x1
    fmov    d1, x0
; D0 - a, D1 - b
    fcmpe    d0, d1
    ble     .L76
; a>b; load D0 (a) into X0
    ldr     x0, [sp,8]
    b      .L74
.L76:
; a<=b; load D1 (b) into X0
    ldr     x0, [sp]

```

```
.L74:
; result in X0
    fmov    d0, x0
; result in D0
    add    sp, sp, 16
    ret
```

Non-optimizing GCC is more verbose.

First, the function saves its input argument values in the local stack (*Register Save Area*). Then the code reloads these values into registers X0/X1 and finally copies them to D0/D1 to be compared using FCMPE. A lot of redundant code, but that is how non-optimizing compilers work. FCMPE compares the values and sets the **APSR** flags. At this moment, the compiler is not thinking yet about the more convenient FCSEL instruction, so it proceed using old methods: using the BLE instruction (*Branch if Less than or Equal*). In the first case ( $a > b$ ), the value of  $a$  gets loaded into X0. In the other case ( $a \leq b$ ), the value of  $b$  gets loaded into X0. Finally, the value from X0 gets copied into D0, because the return value needs to be in this register.

### Exercise

As an exercise, you can try optimizing this piece of code manually by removing redundant instructions and not introducing new ones (including FCSEL).

### Optimizing GCC (Linaro) 4.9—float

Let's also rewrite this example to use *float* instead of *double*.

```
float f_max (float a, float b)
{
    if (a>b)
        return a;

    return b;
};
```

```
f_max:
; S0 - a, S1 - b
    fcmpe  s0, s1
    fcsel  s0, s0, s1, gt
; now result in S0
    ret
```

It is the same code, but the S-registers are used instead of D- ones. It's because numbers of type *float* are passed in 32-bit S-registers (which are in fact the lower parts of the 64-bit D-registers).

### MIPS

The co-processor of the MIPS processor has a condition bit which can be set in the FPU and checked in the CPU.

Earlier MIPS-es have only one condition bit (called FCC0), later ones have 8 (called FCC7-FCC0).

This bit (or bits) are located in the register called FCCR.

Listing 1.227: Optimizing GCC 4.4.5 (IDA)

```
d_max:
; set FPU condition bit if $f14<$f12 (b<a):
    c.lt.d  $f14, $f12
    or     $at, $zero ; NOP
; jump to locret_14 if condition bit is set
    bc1t   locret_14
; this instruction is always executed (set return value to "a"):
    mov.d  $f0, $f12 ; branch delay slot
; this instruction is executed only if branch was not taken (i.e., if b>=a)
```

```

; set return value to "b":
    mov.d    $f0, $f14

locret_14:
    jr      $ra
    or      $at, $zero ; branch delay slot, NOP

```

C.LT.D compares two values. LT is the condition “Less Than”. D implies values of type *double*. Depending on the result of the comparison, the FCC0 condition bit is either set or cleared.

BC1T checks the FCC0 bit and jumps if the bit is set. T means that the jump is to be taken if the bit is set (“True”). There is also the instruction BC1F which jumps if the bit is cleared (“False”).

Depending on the jump, one of function arguments is placed into \$F0.

## 1.25.8 Some constants

It’s easy to find representations of some constants in Wikipedia for IEEE 754 encoded numbers. It’s interesting to know that 0.0 in IEEE 754 is represented as 32 zero bits (for single precision) or 64 zero bits (for double). So in order to set a floating point variable to 0.0 in register or memory, one can use MOV or XOR reg, reg instruction. This is suitable for structures where many variables present of various data types. With usual memset() function one can set all integer variables to 0, all boolean variables to *false*, all pointers to NULL, and all floating point variables (of any precision) to 0.0.

## 1.25.9 Copying

One may think inertially that FLD/FST instructions must be used to load and store (and hence, copy) IEEE 754 values. Nevertheless, same can be achieved easier by usual MOV instruction, which, of course, copies values bitwisely.

## 1.25.10 Stack, calculators and reverse Polish notation

Now we understand why some old programmable calculators use reverse Polish notation.

For example, for addition of 12 and 34 one has to enter 12, then 34, then press “plus” sign.

It’s because old calculators were just stack machine implementations, and this was much simpler than to handle complex parenthesized expressions.

Such a calculator still present in many Unix distributions: *dc*.

## 1.25.11 80 bits?

Internal numbers representation in FPU — 80-bit. Strange number, because the number not in  $2^n$  form. There is a hypothesis that this is probably due to historical reasons—the standard IBM punched card can encode 12 rows of 80 bits. 80·25 text mode resolution was also popular in past.

Wikipedia has another explanation: [https://en.wikipedia.org/wiki/Extended\\_precision](https://en.wikipedia.org/wiki/Extended_precision).

If you know better, please a drop email to the author: <first at last dot com> or <first dot last at gmail dot com>.

## 1.25.12 x64

On how floating point numbers are processed in x86-64, read more here: [1.38 on page 428](#).

## 1.25.13 Exercises

- <http://challenges.re/60>
- <http://challenges.re/61>

## 1.26 Arrays

An array is just a set of variables in memory that lie next to each other and that have the same type<sup>119</sup>.

### 1.26.1 Simple example

```
#include <stdio.h>

int main()
{
    int a[20];
    int i;

    for (i=0; i<20; i++)
        a[i]=i*2;

    for (i=0; i<20; i++)
        printf ("a[%d]=%d\n", i, a[i]);

    return 0;
};
```

**x86**

**MSVC**

Let's compile:

Listing 1.228: MSVC 2008

```
_TEXT    SEGMENT
_i$ = -84                ; size = 4
_a$ = -80                ; size = 80
_main    PROC
    push    ebp
    mov     ebp, esp
    sub     esp, 84        ; 00000054H
    mov     DWORD PTR _i$[ebp], 0
    jmp     SHORT $LN6@main
$LN5@main:
    mov     eax, DWORD PTR _i$[ebp]
    add     eax, 1
    mov     DWORD PTR _i$[ebp], eax
$LN6@main:
    cmp     DWORD PTR _i$[ebp], 20    ; 00000014H
    jge     SHORT $LN4@main
    mov     ecx, DWORD PTR _i$[ebp]
    shl     ecx, 1
    mov     edx, DWORD PTR _i$[ebp]
    mov     DWORD PTR _a$[ebp+edx*4], ecx
    jmp     SHORT $LN5@main
$LN4@main:
    mov     DWORD PTR _i$[ebp], 0
    jmp     SHORT $LN3@main
$LN2@main:
    mov     eax, DWORD PTR _i$[ebp]
    add     eax, 1
    mov     DWORD PTR _i$[ebp], eax
$LN3@main:
    cmp     DWORD PTR _i$[ebp], 20    ; 00000014H
    jge     SHORT $LN1@main
    mov     ecx, DWORD PTR _i$[ebp]
    mov     edx, DWORD PTR _a$[ebp+ecx*4]
    push    edx
    mov     eax, DWORD PTR _i$[ebp]
    push    eax
```

<sup>119</sup>AKA "homogeneous container"

```
    push    OFFSET $SG2463
    call   _printf
    add    esp, 12          ; 0000000cH
    jmp    SHORT $LN2@main
$LN1@main:
    xor    eax, eax
    mov    esp, ebp
    pop    ebp
    ret    0
_main    ENDP
```

Nothing very special, just two loops: the first is a filling loop and second is a printing loop. The `shl ecx, 1` instruction is used for value multiplication by 2 in ECX, more about it: [1.24.2 on page 217](#).

80 bytes are allocated on the stack for the array, 20 elements of 4 bytes.

Let's try this example in OllyDbg.

We see how the array gets filled:

each element is 32-bit word of *int* type and its value is the index multiplied by 2:

The screenshot shows the CPU window with assembly code for a loop that fills an array. The registers window shows EAX=00000014, ECX=00000026, EDX=00000013, etc. The stack window shows the current instruction at address 0040102C. The memory dump window shows the array contents from address 0018FEF4 to 0018FFF4, with values ranging from 00000000 to 00000038.

Address	Hex dump	ASCII (ANSI)
0018FEF4	00 00 00 00 02 00 00 00 04 00 00 00 06 00 00 00	
0018FF04	08 00 00 00 0A 00 00 00 0C 00 00 00 0E 00 00 00	
0018FF14	10 00 00 00 12 00 00 00 14 00 00 00 16 00 00 00	
0018FF24	18 00 00 00 1A 00 00 00 1C 00 00 00 1E 00 00 00	
0018FF34	20 00 00 00 22 00 00 00 24 00 00 00 26 00 00 00	
0018FF44	28 FF 18 00 C0 11 40 00 01 00 00 00 A0 40 58 00	H ↑ L@ @ aM
0018FF54	48 28 58 00 69 CF D1 44 00 00 00 00 00 00 00 00	H( [ i=D
0018FF64	00 E0 FD 7E 00 00 00 00 00 00 00 00 58 FF 18 00	pH" X
0018FF74	A1 1E 96 21 C4 FF 18 00 35 16 40 00 D9 11 89 44	64U↑- ↑ S_e J d
0018FF84	00 00 00 00 94 FF 18 00 0A 33 F6 76 00 E0 FD 7E	φ ↑ K38v p
0018FF94	04 FF 18 00 72 9F D3 77 00 E0 FD 7E 5D DF 93 7E	↑ xA"u pH" ] p
0018FFA4	00 00 00 00 00 00 00 00 00 E0 FD 7E 00 00 00 00	a ↑ pH"
0018FFB4	00 00 00 00 00 00 00 00 A0 FF 18 00 00 00 00 00	a ↑
0018FFC4	E4 FF 18 00 F5 71 D7 77 09 E5 59 09 00 00 00 00	φ ↑ i@#w Xy0
0018FFD4	EC FF 18 00 45 9F D3 77 08 13 40 00 00 E0 FD 7E	↑ EA"u!!@ p
0018FFE4	FF FF FF FF 28 74 DC 77 00 00 00 00 00 00 00	( t#w !!@ p
0018FFF4	08 13 40 00 00 E0 FD 7E 00 00 00 00	!!@ pH"

Figure 1.88: OllyDbg: after array filling

Since this array is located in the stack, we can see all its 20 elements there.

### GCC

Here is what GCC 4.4.1 does:

Listing 1.229: GCC 4.4.1

```

main      public main
          proc near
          ; DATA XREF: _start+17

var_70   = dword ptr -70h
var_6C   = dword ptr -6Ch
var_68   = dword ptr -68h
i_2      = dword ptr -54h
i        = dword ptr -4

          push    ebp
          mov     ebp, esp
          and     esp, 0FFFFFF0h
    
```

```

        sub     esp, 70h
        mov     [esp+70h+i], 0          ; i=0
        jmp     short loc_804840A

loc_80483F7:
        mov     eax, [esp+70h+i]
        mov     edx, [esp+70h+i]
        add     edx, edx                ; edx=i*2
        mov     [esp+eax*4+70h+i_2], edx
        add     [esp+70h+i], 1        ; i++

loc_804840A:
        cmp     [esp+70h+i], 13h
        jle     short loc_80483F7
        mov     [esp+70h+i], 0
        jmp     short loc_8048441

loc_804841B:
        mov     eax, [esp+70h+i]
        mov     edx, [esp+eax*4+70h+i_2]
        mov     eax, offset aADD ; "a[%d]=%d\n"
        mov     [esp+70h+var_68], edx
        mov     edx, [esp+70h+i]
        mov     [esp+70h+var_6C], edx
        mov     [esp+70h+var_70], eax
        call    _printf
        add     [esp+70h+i], 1

loc_8048441:
        cmp     [esp+70h+i], 13h
        jle     short loc_804841B
        mov     eax, 0
        leave
        retn

main     endp

```

By the way, variable *a* is of type *int\** (the pointer to *int*)—you can pass a pointer to an array to another function, but it’s more correct to say that a pointer to the first element of the array is passed (the addresses of rest of the elements are calculated in an obvious way).

If you index this pointer as *a[idx]*, *idx* is just to be added to the pointer and the element placed there (to which calculated pointer is pointing) is to be returned.

An interesting example: a string of characters like *string* is an array of characters and it has a type of *const char[]*.

An index can also be applied to this pointer.

And that is why it is possible to write things like “string”[i]—this is a correct C/C++ expression!

## ARM

### Non-optimizing Keil 6/2013 (ARM mode)

```

EXPORT _main
_main
        STMTFD  SP!, {R4,LR}
        SUB     SP, SP, #0x50          ; allocate place for 20 int variables

; first loop

        MOV     R4, #0                ; i
        B      loc_4A0

loc_494
        MOV     R0, R4, LSL#1         ; R0=R4*2
        STR     R0, [SP,R4,LSL#2]    ; store R0 to SP+R4<<2 (same as SP+R4*4)
        ADD     R4, R4, #1           ; i=i+1

loc_4A0

```

```

        CMP    R4, #20          ; i<20?
        BLT    loc_494          ; yes, run loop body again

; second loop

        MOV    R4, #0           ; i
loc_4B0  B      loc_4C4

        LDR    R2, [SP,R4,LSL#2] ; (second printf argument) R2=*(SP+R4<<4) (same as
        *(SP+R4*4))
        MOV    R1, R4           ; (first printf argument) R1=i
        ADR    R0, aADD         ; "a[%d]=%d\n"
        BL     __2printf
        ADD    R4, R4, #1       ; i=i+1

loc_4C4  CMP    R4, #20          ; i<20?
        BLT    loc_4B0          ; yes, run loop body again
        MOV    R0, #0           ; value to return
        ADD    SP, SP, #0x50     ; deallocate chunk, allocated for 20 int variables
        LDMFD SP!, {R4,PC}

```

*int* type requires 32 bits for storage (or 4 bytes),

so to store 20 *int* variables 80 (0x50) bytes are needed. So that is why the `SUB SP, SP, #0x50` instruction in the function's prologue allocates exactly this amount of space in the stack.

In both the first and second loops, the loop iterator *i* is placed in the R4 register.

The number that is to be written into the array is calculated as  $i * 2$ , which is effectively equivalent to shifting it left by one bit, so `MOV R0, R4,LSL#1` instruction does this.

`STR R0, [SP,R4,LSL#2]` writes the contents of R0 into the array.

Here is how a pointer to array element is calculated: `SP` points to the start of the array, R4 is *i*.

So shifting *i* left by 2 bits is effectively equivalent to multiplication by 4 (since each array element has a size of 4 bytes) and then it's added to the address of the start of the array.

The second loop has an inverse `LDR R2, [SP,R4,LSL#2]` instruction. It loads the value we need from the array, and the pointer to it is calculated likewise.

## Optimizing Keil 6/2013 (Thumb mode)

```

_main
        PUSH   {R4,R5,LR}
; allocate place for 20 int variables + one more variable
        SUB    SP, SP, #0x54

; first loop

        MOVS   R0, #0           ; i
        MOV    R5, SP           ; pointer to first array element

loc_1CE  LSL    R1, R0, #1         ; R1=i<<1 (same as i*2)
        LSL    R2, R0, #2         ; R2=i<<2 (same as i*4)
        ADDS   R0, R0, #1         ; i=i+1
        CMP    R0, #20           ; i<20?
        STR    R1, [R5,R2]       ; store R1 to *(R5+R2) (same R5+i*4)
        BLT    loc_1CE          ; yes, i<20, run loop body again

; second loop

loc_1DC  MOVS   R4, #0           ; i=0

        LSL    R0, R4, #2         ; R0=i<<2 (same as i*4)
        LDR    R2, [R5,R0]       ; load from *(R5+R0) (same as R5+i*4)
        MOVS   R1, R4

```



```

ADR    R0, aADD      ; "a[%d]=%d\n"
BL     __2printf
ADDS   R4, R4, #1    ; i=i+1
CMP    R4, #20       ; i<20?
BLT    loc_1DC       ; yes, i<20, run loop body again
MOVS   R0, #0        ; value to return
; deallocate chunk, allocated for 20 int variables + one more variable
ADD    SP, SP, #0x54
POP    {R4,R5,PC}

```

Thumb code is very similar.

Thumb mode has special instructions for bit shifting (like LSLs), which calculates the value to be written into the array and the address of each element in the array as well.

The compiler allocates slightly more space in the local stack, however, the last 4 bytes are not used.

## Non-optimizing GCC 4.9.1 (ARM64)

Listing 1.230: Non-optimizing GCC 4.9.1 (ARM64)

```

.LC0:
.string "a[%d]=%d\n"
main:
; save FP and LR in stack frame:
stp    x29, x30, [sp, -112]!
; set stack frame (FP=SP)
add    x29, sp, 0
; setting initial counter variable at 0 (WZR is the register always holding zero):
str    wzr, [x29,108]
; jump to loop condition checking code:
b      .L2
.L3:
; load value of "i" variable:
ldr    w0, [x29,108]
; multiply it by 2:
lsl    w2, w0, 1
; find a place of an array in local stack:
add    x0, x29, 24
; load 32-bit integer from local stack and sign extend it to 64-bit one:
ldrsw  x1, [x29,108]
; calculate address of element (X0+X1<<2=array address+i*4) and store W2 (i*2) there:
str    w2, [x0,x1,lsl 2]
; increment counter (i):
ldr    w0, [x29,108]
add    w0, w0, 1
str    w0, [x29,108]
.L2:
; check if we finished:
ldr    w0, [x29,108]
cmp    w0, 19
; jump to L3 (loop body begin) if not:
ble   .L3
; second part of the function begins here.
; setting initial counter variable at 0.
; by the way, the same place in the local stack was used for counter,
; because the same local variable (i) is being used as counter.
str    wzr, [x29,108]
b      .L4
.L5:
; calculate array address:
add    x0, x29, 24
; load "i" value:
ldrsw  x1, [x29,108]
; load value from the array at the address (X0+X1<<2 = address of array + i*4)
ldr    w2, [x0,x1,lsl 2]
; load address of the "a[%d]=%d\n" string:
adrp   x0, .LC0
add    x0, x0, :lo12:.LC0

```

```

; load "i" variable to W1 and pass it to printf() as second argument:
    ldr    w1, [x29,108]
; W2 still contains the value of array element which was just loaded.
; call printf():
    bl    printf
; increment "i" variable:
    ldr    w0, [x29,108]
    add   w0, w0, 1
    str    w0, [x29,108]
.L4:
; are we finished?
    ldr    w0, [x29,108]
    cmp   w0, 19
; jump to the loop body begin if not:
    ble   .L5
; return 0
    mov   w0, 0
; restore FP and LR:
    ldp   x29, x30, [sp], 112
    ret

```

## MIPS

The function uses a lot of S- registers which must be preserved, so that's why its values are saved in the function prologue and restored in the epilogue.

Listing 1.231: Optimizing GCC 4.4.5 (IDA)

```

main:
var_70      = -0x70
var_68      = -0x68
var_14      = -0x14
var_10      = -0x10
var_C       = -0xC
var_8       = -8
var_4       = -4
; function prologue:
    lui   $gp, (__gnu_local_gp >> 16)
    addiu $sp, -0x80
    la    $gp, (__gnu_local_gp & 0xFFFF)
    sw    $ra, 0x80+var_4($sp)
    sw    $s3, 0x80+var_8($sp)
    sw    $s2, 0x80+var_C($sp)
    sw    $s1, 0x80+var_10($sp)
    sw    $s0, 0x80+var_14($sp)
    sw    $gp, 0x80+var_70($sp)
    addiu $s1, $sp, 0x80+var_68
    move  $v1, $s1
    move  $v0, $zero
; that value will be used as a loop terminator.
; it was precalculated by GCC compiler at compile stage:
    li    $a0, 0x28 # '('
loc_34:                                     # CODE XREF: main+3C
; store value into memory:
    sw    $v0, 0($v1)
; increase value to be stored by 2 at each iteration:
    addiu $v0, 2
; loop terminator reached?
    bne   $v0, $a0, loc_34
; add 4 to address anyway:
    addiu $v1, 4
; array filling loop is ended
; second loop begin
    la    $s3, $LC0 # "a[%d]=%d\n"
; "i" variable will reside in $s0:
    move  $s0, $zero
    li    $s2, 0x14

```

```

loc_54:                                     # CODE XREF: main+70
; call printf():
        lw      $t9, (printf & 0xFFFF)($gp)
        lw      $a2, 0($s1)
        move    $a1, $s0
        move    $a0, $s3
        jalr   $t9
; increment "i":
        addiu   $s0, 1
        lw      $gp, 0x80+var_70($sp)
; jump to loop body if end is not reached:
        bne    $s0, $s2, loc_54
; move memory pointer to the next 32-bit word:
        addiu   $s1, 4
; function epilogue
        lw      $ra, 0x80+var_4($sp)
        move    $v0, $zero
        lw      $s3, 0x80+var_8($sp)
        lw      $s2, 0x80+var_C($sp)
        lw      $s1, 0x80+var_10($sp)
        lw      $s0, 0x80+var_14($sp)
        jr     $ra
        addiu   $sp, 0x80

$LC0:   .ascii "a[%d]=%d\n"<0> # DATA XREF: main+44

```

Something interesting: there are two loops and the first one doesn't need  $i$ , it needs only  $i * 2$  (increased by 2 at each iteration) and also the address in memory (increased by 4 at each iteration).

So here we see two variables, one (in  $\$V0$ ) increasing by 2 each time, and another (in  $\$V1$ ) — by 4.

The second loop is where `printf()` is called and it reports the value of  $i$  to the user, so there is a variable which is increased by 1 each time (in  $\$S0$ ) and also a memory address (in  $\$S1$ ) increased by 4 each time.

That reminds us of loop optimizations: [3.10 on page 494](#).

Their goal is to get rid of multiplications.

## 1.26.2 Buffer overflow

### Reading outside array bounds

So, array indexing is just `array[index]`. If you study the generated code closely, you'll probably note the missing index bounds checking, which could check *if it is less than 20*. What if the index is 20 or greater? That's the one C/C++ feature it is often blamed for.

Here is a code that successfully compiles and works:

```

#include <stdio.h>

int main()
{
    int a[20];
    int i;

    for (i=0; i<20; i++)
        a[i]=i*2;

    printf ("a[20]=%d\n", a[20]);

    return 0;
};

```

Compilation results (MSVC 2008):

Listing 1.232: Non-optimizing MSVC 2008

```

$SG2474 DB      'a[20]=%d', 0aH, 00H
_i$ = -84 ; size = 4

```

```

_a$ = -80 ; size = 80
_main PROC
    push    ebp
    mov     ebp, esp
    sub     esp, 84
    mov     DWORD PTR _i$[ebp], 0
    jmp     SHORT $LN3@main
$LN2@main:
    mov     eax, DWORD PTR _i$[ebp]
    add     eax, 1
    mov     DWORD PTR _i$[ebp], eax
$LN3@main:
    cmp     DWORD PTR _i$[ebp], 20
    jge     SHORT $LN1@main
    mov     ecx, DWORD PTR _i$[ebp]
    shl     ecx, 1
    mov     edx, DWORD PTR _i$[ebp]
    mov     DWORD PTR _a$[ebp+edx*4], ecx
    jmp     SHORT $LN2@main
$LN1@main:
    mov     eax, DWORD PTR _a$[ebp+80]
    push    eax
    push    OFFSET $SG2474 ; 'a[20]=%d'
    call   DWORD PTR __imp__printf
    add     esp, 8
    xor     eax, eax
    mov     esp, ebp
    pop     ebp
    ret     0
_main     ENDP
_TEXT    ENDS
END

```

The code produced this result:

Listing 1.233: OllyDbg: console output

```
a[20]=1638280
```

It is just *something* that has been lying in the stack near to the array, 80 bytes away from its first element.

Let's try to find out where did this value come from, using OllyDbg.

Let's load and find the value located right after the last array element:

The screenshot displays the OllyDbg interface with the following components:

- Assembly Window:** Shows instructions from address 00401000 to 00401053. The instruction at 0040102C is highlighted: `MOV EAX, DWORD PTR SS:[LOCAL.0]`. Other instructions include `PUSH EBP`, `MOV EBP, ESP`, `SUB ESP, 54`, `MOV DWORD PTR SS:[LOCAL.21], 0`, `JMP SHORT 00401018`, `MOV EAX, DWORD PTR SS:[LOCAL.21]`, `ADD EAX, 1`, `MOV DWORD PTR SS:[LOCAL.21], EAX`, `CMP DWORD PTR SS:[LOCAL.21], 14`, `JGE SHORT 0040102C`, `MOV ECX, DWORD PTR SS:[LOCAL.21]`, `SHL ECX, 1`, `MOV EDX, DWORD PTR SS:[LOCAL.21]`, `MOV DWORD PTR SS:[EDX*4+EBP-50], ECX`, and `JMP SHORT 0040100F`.
- Registers (FPU) Window:** Shows register values: EAX=00000014, ECX=00000026, EDX=00000013, EBX=00000000, ESP=0018FEF0, EBP=0018FF44, ESI=00000001, EDI=0040338C r.0040338C, EIP=0040102C r.0040102C. Control registers (C, P, A, Z, S, T, D, O) are also shown.
- Stack Window:** Shows the current stack frame: `Stack [0018FF44]=0018FF88`, `EAX=00000014 (decimal 20.)`, and `Jump from 40101C`.
- Memory Dump Window:** Shows a hex dump of memory from 0018FF40 to 0018FF4F. The value at 0018FF44 is `88 FF 18 00`, which is highlighted with a red box. The ASCII window shows the corresponding characters: `H` at 0018FF44.
- Registers (FPU) Window (continued):** Shows the value at 0018FF44: `0018FF44 00000014` with a red box around it. The value at 0018FF48 is `00401190` with a red box around it, and the text `RETURN from r.00401190` is visible.

Figure 1.89: OllyDbg: reading of the 20th element and execution of `printf()`

What is this? Judging by the stack layout, this is the saved value of the EBP register.

Let's trace further and see how it gets restored:

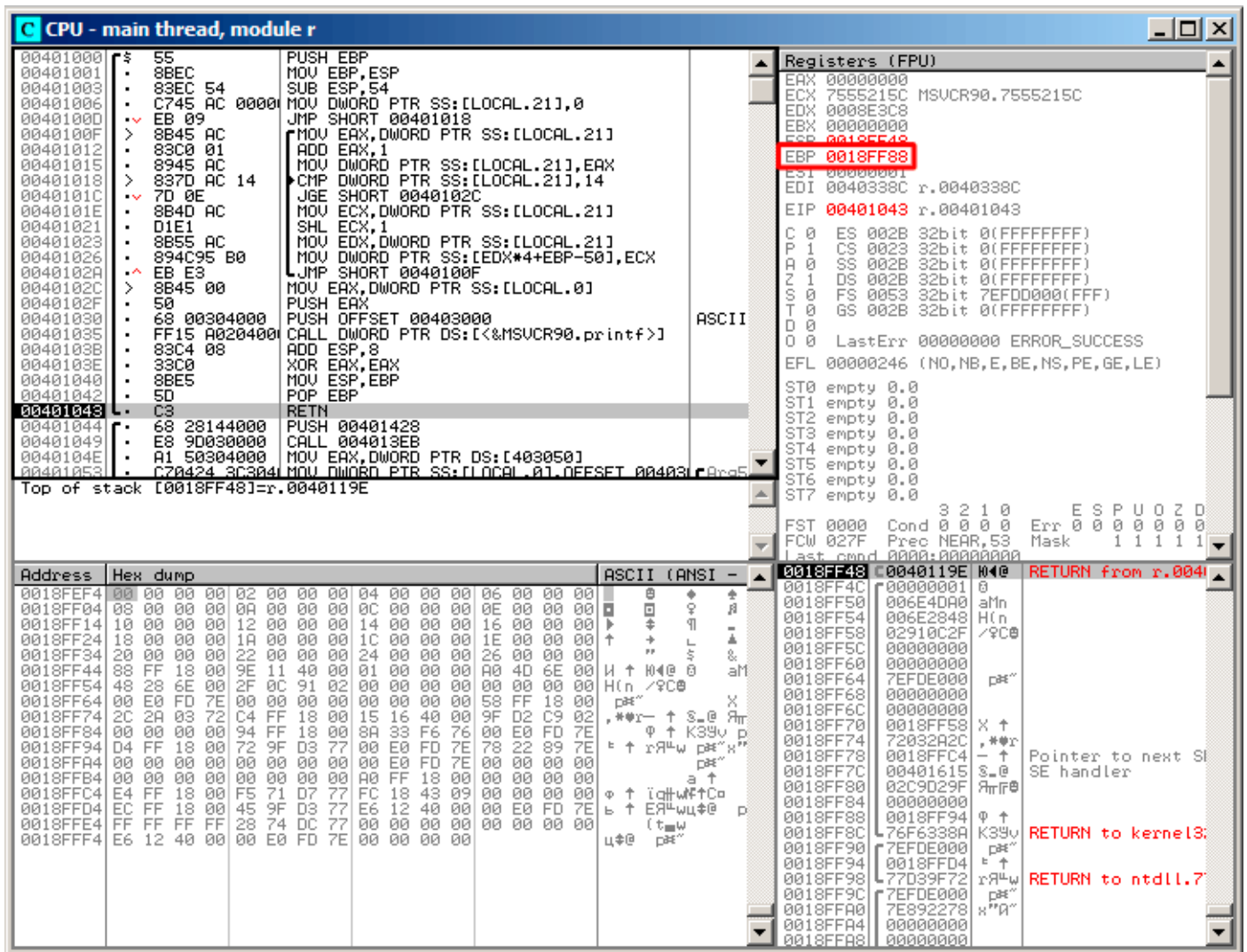

Figure 1.90: OllyDbg: restoring value of EBP

Indeed, how it could be different? The compiler may generate some additional code to check the index value to be always in the array's bounds (like in higher-level programming languages<sup>120</sup>) but this makes the code slower.

### Writing beyond array bounds

OK, we read some values from the stack *illegally*, but what if we could write something to it?

Here is what we have got:

```
#include <stdio.h>

int main()
{
    int a[20];
    int i;

    for (i=0; i<30; i++)
        a[i]=i;

    return 0;
};
```

<sup>120</sup>Java, Python, etc.

## MSVC

And what we get:

Listing 1.234: Non-optimizing MSVC 2008

```
_TEXT    SEGMENT
_i$ = -84 ; size = 4
_a$ = -80 ; size = 80
_main   PROC
  push   ebp
  mov    ebp, esp
  sub    esp, 84
  mov    DWORD PTR _i$[ebp], 0
  jmp    SHORT $LN3@main
$LN2@main:
  mov    eax, DWORD PTR _i$[ebp]
  add    eax, 1
  mov    DWORD PTR _i$[ebp], eax
$LN3@main:
  cmp    DWORD PTR _i$[ebp], 30 ; 0000001eH
  jge    SHORT $LN1@main
  mov    ecx, DWORD PTR _i$[ebp]
  mov    edx, DWORD PTR _i$[ebp] ; that instruction is obviously redundant
  mov    DWORD PTR _a$[ebp+ecx*4], edx ; ECX could be used as second operand here instead
  jmp    SHORT $LN2@main
$LN1@main:
  xor    eax, eax
  mov    esp, ebp
  pop    ebp
  ret    0
_main   ENDP
```

The compiled program crashes after running. No wonder. Let's see where exactly does it crash.

Let's load it into OllyDbg, and trace until all 30 elements are written:

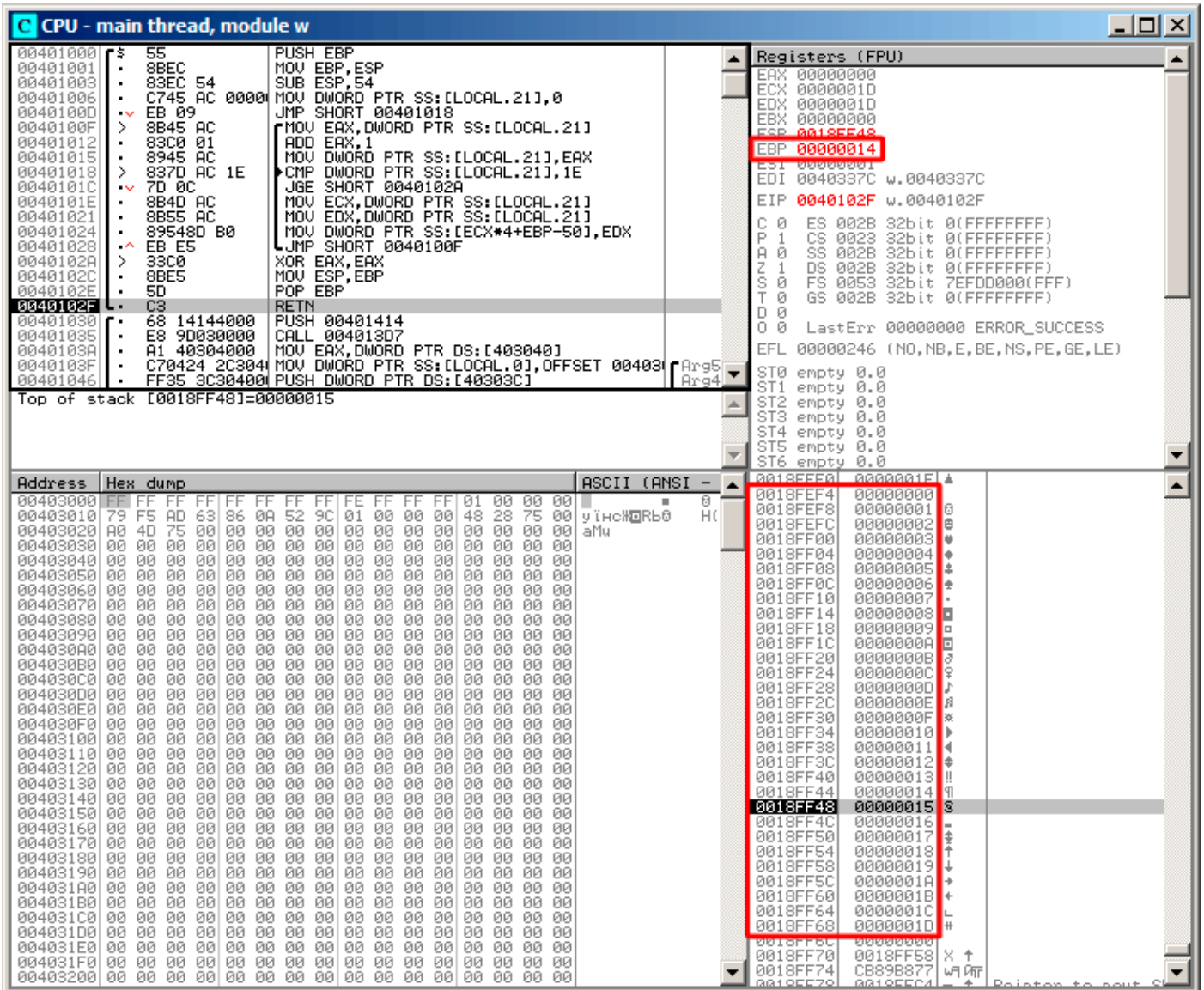

Figure 1.91: OllyDbg: after restoring the value of EBP



Trace until the function end:

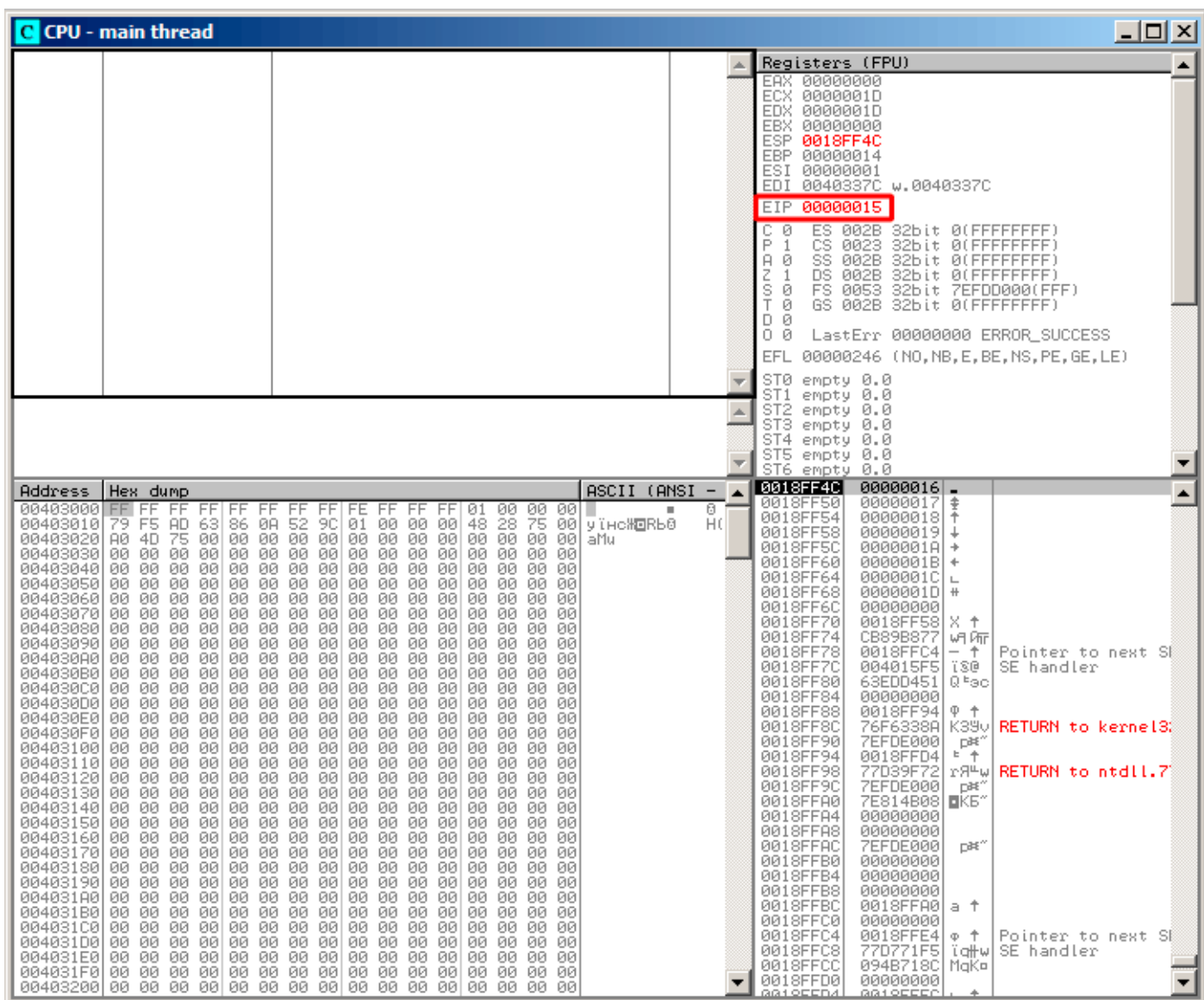

Figure 1.92: OllyDbg: EIP has been restored, but OllyDbg can't disassemble at 0x15

Now please keep your eyes on the registers.

EIP is 0x15 now. It is not a legal address for code—at least for win32 code! We got there somehow against our will. It is also interesting that the EBP register contain 0x14, ECX and EDX contain 0x1D.

Let's study stack layout a bit more.

After the control flow has been passed to main(), the value in the EBP register was saved on the stack. Then, 84 bytes were allocated for the array and the *i* variable. That's (20+1)\*sizeof(int). ESP now points to the *\_i* variable in the local stack and after the execution of the next PUSH something, something is appearing next to *\_i*.

That's the stack layout while the control is in main():

ESP	4 bytes allocated for <i>i</i> variable
ESP+4	80 bytes allocated for a[20] array
ESP+84	saved EBP value
ESP+88	return address

a[19]=something statement writes the last *int* in the bounds of the array (in bounds so far!).

a[20]=something statement writes something to the place where the value of EBP is saved.

Please take a look at the register state at the moment of the crash. In our case, 20 has been written in the 20th element. At the function end, the function epilogue restores the original EBP value. (20 in decimal

is 0x14 in hexadecimal). Then RET gets executed, which is effectively equivalent to POP EIP instruction. The RET instruction takes the return address from the stack (that is the address in CRT, which has called main()), and 21 is stored there (0x15 in hexadecimal). The CPU traps at address 0x15, but there is no executable code there, so exception gets raised.

Welcome! It is called a *buffer overflow*<sup>121</sup>.

Replace the *int* array with a string (*char* array), create a long string deliberately and pass it to the program, to the function, which doesn't check the length of the string and copies it in a short buffer, and you'll be able to point the program to an address to which it must jump. It's not that simple in reality, but that is how it emerged. Classic article about it: [Aleph One, *Smashing The Stack For Fun And Profit*, (1996)]<sup>122</sup>.

## GCC

Let's try the same code in GCC 4.4.1. We get:

```
main          public main
              proc near

a             = dword ptr -54h
i             = dword ptr -4

              push    ebp
              mov     ebp, esp
              sub     esp, 60h ; 96
              mov     [ebp+i], 0
              jmp     short loc_80483D1

loc_80483C3:  mov     eax, [ebp+i]
              mov     edx, [ebp+i]
              mov     [ebp+eax*4+a], edx
              add     [ebp+i], 1

loc_80483D1:  cmp     [ebp+i], 1Dh
              jle     short loc_80483C3
              mov     eax, 0
              leave
              retn
main          endp
```

Running this in Linux will produce: Segmentation fault.

If we run this in the GDB debugger, we get this:

```
(gdb) r
Starting program: /home/dennis/RE/1

Program received signal SIGSEGV, Segmentation fault.
0x00000016 in ?? ()
(gdb) info registers
eax          0x0          0
ecx          0xd2f96388    -755407992
edx          0x1d         29
ebx          0x26eff4     2551796
esp          0xbffff4b0    0xbffff4b0
ebp          0x15         0x15
esi          0x0          0
edi          0x0          0
eip          0x16         0x16
eflags      0x10202    [ IF RF ]
cs          0x73         115
ss          0x7b         123
ds          0x7b         123
es          0x7b         123
fs          0x0          0
```

<sup>121</sup>[wikipedia](#)

<sup>122</sup>Also available as <http://go.yurichev.com/17266>

```
gs          0x33    51
(gdb)
```

The register values are slightly different than in win32 example, since the stack layout is slightly different too.

### 1.26.3 Buffer overflow protection methods

There are several methods to protect against this scourge, regardless of the C/C++ programmers' negligence. MSVC has options like<sup>123</sup>:

```
/RTCs Stack Frame runtime checking
/GZ Enable stack checks (/RTCs)
```

One of the methods is to write a random value between the local variables in stack at function prologue and to check it in function epilogue before the function exits. If value is not the same, do not execute the last instruction RET, but stop (or hang). The process will halt, but that is much better than a remote attack to your host.

This random value is called a "canary" sometimes, it is related to the miners' canary<sup>124</sup>, they were used by miners in the past days in order to detect poisonous gases quickly.

Canaries are very sensitive to mine gases, they become very agitated in case of danger, or even die.

If we compile our very simple array example ( 1.26.1 on page 266) in MSVC with RTC1 and RTCs option, you can see a call to @ \_RTC\_CheckStackVars@8 a function at the end of the function that checks if the "canary" is correct.

Let's see how GCC handles this. Let's take an alloca() ( 1.9.2 on page 35) example:

```
#ifdef __GNUC__
#include <alloca.h> // GCC
#else
#include <malloc.h> // MSVC
#endif
#include <stdio.h>

void f()
{
    char *buf=(char*)alloca (600);
#ifdef __GNUC__
    snprintf (buf, 600, "hi! %d, %d, %d\n", 1, 2, 3); // GCC
#else
    _snprintf (buf, 600, "hi! %d, %d, %d\n", 1, 2, 3); // MSVC
#endif

    puts (buf);
};
```

By default, without any additional options, GCC 4.7.3 inserts a "canary" check into the code:

Listing 1.235: GCC 4.7.3

```
.LC0:
.string "hi! %d, %d, %d\n"
f:
    push    ebp
    mov     ebp, esp
    push    ebx
    sub     esp, 676
    lea    ebx, [esp+39]
    and     ebx, -16
    mov     DWORD PTR [esp+20], 3
    mov     DWORD PTR [esp+16], 2
    mov     DWORD PTR [esp+12], 1
    mov     DWORD PTR [esp+8], OFFSET FLAT:.LC0 ; "hi! %d, %d, %d\n"
```

<sup>123</sup>compiler-side buffer overflow protection methods: [wikipedia.org/wiki/Buffer\\_overflow\\_protection](http://wikipedia.org/wiki/Buffer_overflow_protection)

<sup>124</sup>[wikipedia.org/wiki/Domestic\\_canary#Miner.27s\\_canary](http://wikipedia.org/wiki/Domestic_canary#Miner.27s_canary)

```

    mov     DWORD PTR [esp+4], 600
    mov     DWORD PTR [esp], ebx
    mov     eax, DWORD PTR gs:20      ; canary
    mov     DWORD PTR [ebp-12], eax
    xor     eax, eax
    call   _sprintf
    mov     DWORD PTR [esp], ebx
    call   puts
    mov     eax, DWORD PTR [ebp-12]
    xor     eax, DWORD PTR gs:20      ; check canary
    jne    .L5
    mov     ebx, DWORD PTR [ebp-4]
    leave
    ret
.L5:
    call   __stack_chk_fail

```

The random value is located in `gs:20`. It gets written on the stack and then at the end of the function the value in the stack is compared with the correct “canary” in `gs:20`. If the values are not equal, the `__stack_chk_fail` function is called and we can see in the console something like that (Ubuntu 13.04 x86):

```

*** buffer overflow detected ***: ./2_1 terminated
===== Backtrace: =====
/lib/i386-linux-gnu/libc.so.6(__fortify_fail+0x63)[0xb7699bc3]
/lib/i386-linux-gnu/libc.so.6(+0x10593a)[0xb769893a]
/lib/i386-linux-gnu/libc.so.6(+0x105008)[0xb7698008]
/lib/i386-linux-gnu/libc.so.6(_IO_default_xsputn+0x8c)[0xb7606e5c]
/lib/i386-linux-gnu/libc.so.6(_IO_vfprintf+0x165)[0xb75d7a45]
/lib/i386-linux-gnu/libc.so.6(__vsprintf_chk+0xc9)[0xb76980d9]
/lib/i386-linux-gnu/libc.so.6(__sprintf_chk+0x2f)[0xb7697fef]
./2_1[0x8048404]
/lib/i386-linux-gnu/libc.so.6(__libc_start_main+0xf5)[0xb75ac935]
===== Memory map: =====
08048000-08049000 r-xp 00000000 08:01 2097586 /home/dennis/2_1
08049000-0804a000 r--p 00000000 08:01 2097586 /home/dennis/2_1
0804a000-0804b000 rw-p 00001000 08:01 2097586 /home/dennis/2_1
094d1000-094f2000 rw-p 00000000 00:00 0 [heap]
b7560000-b757b000 r-xp 00000000 08:01 1048602 /lib/i386-linux-gnu/libgcc_s.so.1
b757b000-b757c000 r--p 0001a000 08:01 1048602 /lib/i386-linux-gnu/libgcc_s.so.1
b757c000-b757d000 rw-p 0001b000 08:01 1048602 /lib/i386-linux-gnu/libgcc_s.so.1
b7592000-b7593000 rw-p 00000000 00:00 0
b7593000-b7740000 r-xp 00000000 08:01 1050781 /lib/i386-linux-gnu/libc-2.17.so
b7740000-b7742000 r--p 001ad000 08:01 1050781 /lib/i386-linux-gnu/libc-2.17.so
b7742000-b7743000 rw-p 001af000 08:01 1050781 /lib/i386-linux-gnu/libc-2.17.so
b7743000-b7746000 rw-p 00000000 00:00 0
b775a000-b775d000 rw-p 00000000 00:00 0
b775d000-b775e000 r-xp 00000000 00:00 0 [vdso]
b775e000-b777e000 r-xp 00000000 08:01 1050794 /lib/i386-linux-gnu/ld-2.17.so
b777e000-b777f000 r--p 0001f000 08:01 1050794 /lib/i386-linux-gnu/ld-2.17.so
b777f000-b7780000 rw-p 00020000 08:01 1050794 /lib/i386-linux-gnu/ld-2.17.so
bff35000-bff56000 rw-p 00000000 00:00 0 [stack]
Aborted (core dumped)

```

`gs` is the so-called segment register. These registers were used widely in MS-DOS and DOS-extenders times. Today, its function is different.

To say it briefly, the `gs` register in Linux always points to the [TLS<sup>125</sup>](#) ( 6.2 on page 744)—some information specific to thread is stored there. By the way, in win32 the `fs` register plays the same role, pointing to [TIB<sup>126 127</sup>](#).

More information can be found in the Linux kernel source code (at least in 3.11 version), in `arch/x86/include/asm/stackprotector.h` this variable is described in the comments.

<sup>125</sup>Thread Local Storage

<sup>126</sup>Thread Information Block

<sup>127</sup>[wikipedia.org/wiki/Win32\\_Thread\\_Information\\_Block](http://wikipedia.org/wiki/Win32_Thread_Information_Block)

## Optimizing Xcode 4.6.3 (LLVM) (Thumb-2 mode)

Let's get back to our simple array example ( [1.26.1 on page 266](#)),

again, now we can see how LLVM checks the correctness of the "canary":

```
_main
var_64      = -0x64
var_60      = -0x60
var_5C      = -0x5C
var_58      = -0x58
var_54      = -0x54
var_50      = -0x50
var_4C      = -0x4C
var_48      = -0x48
var_44      = -0x44
var_40      = -0x40
var_3C      = -0x3C
var_38      = -0x38
var_34      = -0x34
var_30      = -0x30
var_2C      = -0x2C
var_28      = -0x28
var_24      = -0x24
var_20      = -0x20
var_1C      = -0x1C
var_18      = -0x18
canary      = -0x14
var_10      = -0x10

    PUSH    {R4-R7,LR}
    ADD     R7, SP, #0xC
    STR.W   R8, [SP,#0xC+var_10]!
    SUB     SP, SP, #0x54
    MOVW   R0, #a0bjc_methtype ; "objc_methtype"
    MOVS   R2, #0
    MOVT.W R0, #0
    MOVS   R5, #0
    ADD    R0, PC
    LDR.W  R8, [R0]
    LDR.W  R0, [R8]
    STR    R0, [SP,#0x64+canary]
    MOVS   R0, #2
    STR    R2, [SP,#0x64+var_64]
    STR    R0, [SP,#0x64+var_60]
    MOVS   R0, #4
    STR    R0, [SP,#0x64+var_5C]
    MOVS   R0, #6
    STR    R0, [SP,#0x64+var_58]
    MOVS   R0, #8
    STR    R0, [SP,#0x64+var_54]
    MOVS   R0, #0xA
    STR    R0, [SP,#0x64+var_50]
    MOVS   R0, #0xC
    STR    R0, [SP,#0x64+var_4C]
    MOVS   R0, #0xE
    STR    R0, [SP,#0x64+var_48]
    MOVS   R0, #0x10
    STR    R0, [SP,#0x64+var_44]
    MOVS   R0, #0x12
    STR    R0, [SP,#0x64+var_40]
    MOVS   R0, #0x14
    STR    R0, [SP,#0x64+var_3C]
    MOVS   R0, #0x16
    STR    R0, [SP,#0x64+var_38]
    MOVS   R0, #0x18
    STR    R0, [SP,#0x64+var_34]
    MOVS   R0, #0x1A
    STR    R0, [SP,#0x64+var_30]
    MOVS   R0, #0x1C
```

```

STR    R0, [SP,#0x64+var_2C]
MOVS   R0, #0x1E
STR    R0, [SP,#0x64+var_28]
MOVS   R0, #0x20
STR    R0, [SP,#0x64+var_24]
MOVS   R0, #0x22
STR    R0, [SP,#0x64+var_20]
MOVS   R0, #0x24
STR    R0, [SP,#0x64+var_1C]
MOVS   R0, #0x26
STR    R0, [SP,#0x64+var_18]
MOV    R4, 0xFDA ; "a[%d]=%d\n"
MOV    R0, SP
ADDS   R6, R0, #4
ADD    R4, PC
B      loc_2F1C

; second loop begin

loc_2F14
ADDS   R0, R5, #1
LDR.W  R2, [R6,R5,LSL#2]
MOV    R5, R0

loc_2F1C
MOV    R0, R4
MOV    R1, R5
BLX    _printf
CMP    R5, #0x13
BNE    loc_2F14
LDR.W  R0, [R8]
LDR    R1, [SP,#0x64+canary]
CMP    R0, R1
ITTTT EQ          ; is canary still correct?
MOVEQ  R0, #0
ADDEQ  SP, SP, #0x54
LDREQ.W R8, [SP+0x64+var_64],#4
POPEQ  {R4-R7,PC}
BLX    ___stack_chk_fail

```

First of all, as we see, LLVM “unrolled” the loop and all values were written into an array one-by-one, pre-calculated, as LLVM concluded it can work faster. By the way, instructions in ARM mode may help to do this even faster, and finding this could be your homework.

At the function end we see the comparison of the “canaries”—the one in the local stack and the correct one, to which R8 points.

If they are equal to each other, a 4-instruction block is triggered by ITTTT EQ, which contains writing 0 in R0, the function epilogue and exit. If the “canaries” are not equal, the block being skipped, and the jump to \_\_\_stack\_chk\_fail function will occur, which, perhaps will halt execution.

### 1.26.4 One more word about arrays

Now we understand why it is impossible to write something like this in C/C++ code:

```

void f(int size)
{
    int a[size];
    ...
};

```

That’s just because the compiler must know the exact array size to allocate space for it in the local stack layout on at the compiling stage.

If you need an array of arbitrary size, allocate it by using malloc(), then access the allocated memory block as an array of variables of the type you need.

Or use the C99 standard feature [ISO/IEC 9899:TC3 (C C99 standard), (2007)6.7.5/2], and it works like `alloca()` ( [1.9.2 on page 35](#)) internally.

It's also possible to use garbage collecting libraries for C.

And there are also libraries supporting smart pointers for C++.

## 1.26.5 Array of pointers to strings

Here is an example for an array of pointers.

Listing 1.236: Get month name

```
#include <stdio.h>

const char* month1[]=
{
    "January", "February", "March", "April",
    "May", "June", "July", "August",
    "September", "October", "November", "December"
};

// in 0..11 range
const char* get_month1 (int month)
{
    return month1[month];
};
```

## x64

Listing 1.237: Optimizing MSVC 2013 x64

```
_DATA SEGMENT
month1 DQ FLAT:$SG3122
      DQ FLAT:$SG3123
      DQ FLAT:$SG3124
      DQ FLAT:$SG3125
      DQ FLAT:$SG3126
      DQ FLAT:$SG3127
      DQ FLAT:$SG3128
      DQ FLAT:$SG3129
      DQ FLAT:$SG3130
      DQ FLAT:$SG3131
      DQ FLAT:$SG3132
      DQ FLAT:$SG3133
$SG3122 DB 'January', 00H
$SG3123 DB 'February', 00H
$SG3124 DB 'March', 00H
$SG3125 DB 'April', 00H
$SG3126 DB 'May', 00H
$SG3127 DB 'June', 00H
$SG3128 DB 'July', 00H
$SG3129 DB 'August', 00H
$SG3130 DB 'September', 00H
$SG3156 DB '%s', 0aH, 00H
$SG3131 DB 'October', 00H
$SG3132 DB 'November', 00H
$SG3133 DB 'December', 00H
_DATA ENDS

month$ = 8
get_month1 PROC
    movsxd rax, ecx
    lea rcx, OFFSET FLAT:month1
    mov rax, QWORD PTR [rcx+rax*8]
    ret 0
get_month1 ENDP
```

The code is very simple:

- The first MOVSXD instruction copies a 32-bit value from ECX (where *month* argument is passed) to RAX with sign-extension (because the *month* argument is of type *int*).

The reason for the sign extension is that this 32-bit value is to be used in calculations with other 64-bit values.

Hence, it has to be promoted to 64-bit<sup>128</sup>.

- Then the address of the pointer table is loaded into RCX.
- Finally, the input value (*month*) is multiplied by 8 and added to the address. Indeed: we are in a 64-bit environment and all address (or pointers) require exactly 64 bits (or 8 bytes) for storage. Hence, each table element is 8 bytes wide. And that's why to pick a specific element,  $month * 8$  bytes has to be skipped from the start. That's what MOV does. In addition, this instruction also loads the element at this address. For 1, an element would be a pointer to a string that contains "February", etc.

Optimizing GCC 4.9 can do the job even better <sup>129</sup>:

Listing 1.238: Optimizing GCC 4.9 x64

```
movsx    rdi, edi
mov      rax, QWORD PTR month1[0+rdi*8]
ret
```

### 32-bit MSVC

Let's also compile it in the 32-bit MSVC compiler:

Listing 1.239: Optimizing MSVC 2013 x86

```
_month$ = 8
_get_month1 PROC
    mov     eax, DWORD PTR _month$[esp-4]
    mov     eax, DWORD PTR _month1[eax*4]
    ret     0
_get_month1 ENDP
```

The input value does not need to be extended to 64-bit value, so it is used as is. And it's multiplied by 4, because the table elements are 32-bit (or 4 bytes) wide.

### 32-bit ARM

#### ARM in ARM mode

Listing 1.240: Optimizing Keil 6/2013 (ARM mode)

```
get_month1 PROC
    LDR    r1, |L0.100|
    LDR    r0, [r1, r0, LSL #2]
    BX    lr
    ENDP

|L0.100|
    DCD    |.data|

    DCB    "January", 0
    DCB    "February", 0
    DCB    "March", 0
    DCB    "April", 0
    DCB    "May", 0
    DCB    "June", 0
    DCB    "July", 0
```

<sup>128</sup>It is somewhat weird, but negative array index could be passed here as *month* (negative array indices will have been explained later: [3.22 on page 597](#)). And if this happens, the negative input value of *int* type is sign-extended correctly and the corresponding element before table is picked. It is not going to work correctly without sign-extension.

<sup>129</sup>"0+" was left in the listing because GCC assembler output is not tidy enough to eliminate it. It's *displacement*, and it's zero here.



```

    DCB    "August",0
    DCB    "September",0
    DCB    "October",0
    DCB    "November",0
    DCB    "December",0

    AREA  ||.data||, DATA, ALIGN=2
month1
    DCD    ||.conststring||
    DCD    ||.conststring||+0x8
    DCD    ||.conststring||+0x11
    DCD    ||.conststring||+0x17
    DCD    ||.conststring||+0x1d
    DCD    ||.conststring||+0x21
    DCD    ||.conststring||+0x26
    DCD    ||.conststring||+0x2b
    DCD    ||.conststring||+0x32
    DCD    ||.conststring||+0x3c
    DCD    ||.conststring||+0x44
    DCD    ||.conststring||+0x4d

```

The address of the table is loaded in R1.

All the rest is done using just one LDR instruction.

Then input value *month* is shifted left by 2 (which is the same as multiplying by 4), then added to R1 (where the address of the table is) and then a table element is loaded from this address.

The 32-bit table element is loaded into R0 from the table.

### ARM in Thumb mode

The code is mostly the same, but less dense, because the LSL suffix cannot be specified in the LDR instruction here:

```

get_month1 PROC
    LSLS    r0,r0,#2
    LDR     r1,|L0.64|
    LDR     r0,[r1,r0]
    BX     lr
ENDP

```

### ARM64

Listing 1.241: Optimizing GCC 4.9 ARM64

```

get_month1:
    adrp   x1, .LANCHOR0
    add    x1, x1, :lo12:.LANCHOR0
    ldr    x0, [x1,w0,sxtw 3]
    ret

.LANCHOR0 = . + 0
.type    month1, %object
.size    month1, 96
month1:
    .xword .LC2
    .xword .LC3
    .xword .LC4
    .xword .LC5
    .xword .LC6
    .xword .LC7
    .xword .LC8
    .xword .LC9
    .xword .LC10
    .xword .LC11
    .xword .LC12

```

```

.xword .LC13
.LC2: .string "January"
.LC3: .string "February"
.LC4: .string "March"
.LC5: .string "April"
.LC6: .string "May"
.LC7: .string "June"
.LC8: .string "July"
.LC9: .string "August"
.LC10: .string "September"
.LC11: .string "October"
.LC12: .string "November"
.LC13: .string "December"

```

The address of the table is loaded in X1 using ADRP/ADD pair.

Then corresponding element is picked using just one LDR, which takes W0 (the register where input argument *month* is), shifts it 3 bits to the left (which is the same as multiplying by 8), sign-extends it (this is what "sxtw" suffix implies) and adds to X0. Then the 64-bit value is loaded from the table into X0.

## MIPS

Listing 1.242: Optimizing GCC 4.4.5 (IDA)

```

get_month1:
; load address of table into $v0:
    la    $v0, month1
; take input value and multiply it by 4:
    sll   $a0, 2
; sum up address of table and multiplied value:
    addu  $a0, $v0
; load table element at this address into $v0:
    lw    $v0, 0($a0)
; return
    jr    $ra
    or    $at, $zero ; branch delay slot, NOP

    .data # .data.rel.local
    .globl month1
month1:
    .word aJanuary      # "January"
    .word aFebruary    # "February"
    .word aMarch        # "March"
    .word aApril        # "April"
    .word aMay          # "May"
    .word aJune         # "June"
    .word aJuly         # "July"
    .word aAugust       # "August"
    .word aSeptember   # "September"
    .word aOctober      # "October"
    .word aNovember    # "November"
    .word aDecember     # "December"

    .data # .rodata.str1.4
aJanuary: .ascii "January"<0>
aFebruary: .ascii "February"<0>
aMarch: .ascii "March"<0>
aApril: .ascii "April"<0>
aMay: .ascii "May"<0>

```

```

aJune:      .ascii "June"<0>
aJuly:      .ascii "July"<0>
aAugust:    .ascii "August"<0>
aSeptember: .ascii "September"<0>
aOctober:   .ascii "October"<0>
aNovember:  .ascii "November"<0>
aDecember:  .ascii "December"<0>

```

## Array overflow

Our function accepts values in the range of 0..11, but what if 12 is passed? There is no element in table at this place.

So the function will load some value which happens to be there, and return it.

Soon after, some other function can try to get a text string from this address and may crash.

Let's compile the example in MSVC for win64 and open it in [IDA](#) to see what the linker has placed after the table:

Listing 1.243: Executable file in IDA

```

off_140011000  dq offset aJanuary_1    ; DATA XREF: .text:0000000140001003
                ; "January"
                dq offset aFebruary_1    ; "February"
                dq offset aMarch_1       ; "March"
                dq offset aApril_1       ; "April"
                dq offset aMay_1         ; "May"
                dq offset aJune_1        ; "June"
                dq offset aJuly_1        ; "July"
                dq offset aAugust_1      ; "August"
                dq offset aSeptember_1   ; "September"
                dq offset aOctober_1     ; "October"
                dq offset aNovember_1    ; "November"
                dq offset aDecember_1    ; "December"
aJanuary_1    db 'January',0          ; DATA XREF: sub_140001020+4
                ; .data:off_140011000
aFebruary_1   db 'February',0         ; DATA XREF: .data:0000000140011008
                align 4
aMarch_1      db 'March',0            ; DATA XREF: .data:0000000140011010
                align 4
aApril_1      db 'April',0            ; DATA XREF: .data:0000000140011018

```

Month names are came right after.

Our program is tiny, so there isn't much data to pack in the data segment, so it just the month names. But it has to be noted that there might be really *anything* that linker has decided to put by chance.

So what if 12 is passed to the function? The 13th element will be returned.

Let's see how the CPU treats the bytes there as a 64-bit value:

Listing 1.244: Executable file in IDA

```

off_140011000  dq offset qword_140011060
                ; DATA XREF: .text:0000000140001003
                dq offset aFebruary_1    ; "February"
                dq offset aMarch_1       ; "March"
                dq offset aApril_1       ; "April"
                dq offset aMay_1         ; "May"
                dq offset aJune_1        ; "June"
                dq offset aJuly_1        ; "July"
                dq offset aAugust_1      ; "August"
                dq offset aSeptember_1   ; "September"
                dq offset aOctober_1     ; "October"
                dq offset aNovember_1    ; "November"
                dq offset aDecember_1    ; "December"
qword_140011060 dq 797261756E614Ah      ; DATA XREF: sub_140001020+4
                ; .data:off_140011000
aFebruary_1   db 'February',0         ; DATA XREF: .data:0000000140011008
                align 4
aMarch_1      db 'March',0            ; DATA XREF: .data:0000000140011010

```

And this is 0x797261756E614A.

Soon after, some other function (presumably, one that processes strings) may try to read bytes at this address, expecting a C-string there.

Most likely it is about to crash, because this value doesn't look like a valid address.

## Array overflow protection

If something can go wrong, it will

Murphy's Law

It's a bit naïve to expect that every programmer who use your function or library will never pass an argument larger than 11.

There exists the philosophy that says "fail early and fail loudly" or "fail-fast", which teaches to report problems as early as possible and halt.

One such method in C/C++ is assertions.

We can modify our program to fail if an incorrect value is passed:

Listing 1.245: assert() added

```
const char* get_month1_checked (int month)
{
    assert (month<12);
    return month1[month];
};
```

The assertion macro checks for valid values at every function start and fails if the expression is false.

Listing 1.246: Optimizing MSVC 2013 x64

```
$SG3143 DB      'm', 00H, 'o', 00H, 'n', 00H, 't', 00H, 'h', 00H, '.', 00H
        DB      'c', 00H, 00H, 00H
$SG3144 DB      'm', 00H, 'o', 00H, 'n', 00H, 't', 00H, 'h', 00H, '<', 00H
        DB      '1', 00H, '2', 00H, 00H, 00H

month$ = 48
get_month1_checked PROC
$LN5:
    push     rbx
    sub     rsp, 32
    movsxd  rbx, ecx
    cmp     ebx, 12
    jl     SHORT $LN3@get_month1
    lea     rdx, OFFSET FLAT:$SG3143
    lea     rcx, OFFSET FLAT:$SG3144
    mov     r8d, 29
    call    _wassert
$LN3@get_month1:
    lea     rcx, OFFSET FLAT:month1
    mov     rax, QWORD PTR [rcx+rbx*8]
    add     rsp, 32
    pop     rbx
    ret     0
get_month1_checked ENDP
```

In fact, assert() is not a function, but macro. It checks for a condition, then passes also the line number and file name to another function which reports this information to the user.

Here we see that both file name and condition are encoded in UTF-16. The line number is also passed (it's 29).

This mechanism is probably the same in all compilers. Here is what GCC does:

Listing 1.247: Optimizing GCC 4.9 x64

```
.LC1:
.string "month.c"
```

```

.LC2:
    .string "month<12"

get_month1_checked:
    cmp     edi, 11
    jg     .L6
    movsx  rdi, edi
    mov    rax, QWORD PTR month1[0+rdi*8]
    ret

.L6:
    push   rax
    mov    ecx, OFFSET FLAT:__PRETTY_FUNCTION__.2423
    mov    edx, 29
    mov    esi, OFFSET FLAT:.LC1
    mov    edi, OFFSET FLAT:.LC2
    call  __assert_fail

__PRETTY_FUNCTION__.2423:
    .string "get_month1_checked"

```

So the macro in GCC also passes the function name for convenience.

Nothing is really free, and this is true for the sanitizing checks as well.

They make your program slower, especially if the `assert()` macros used in small time-critical functions.

So MSVC, for example, leaves the checks in debug builds, but in release builds they all disappear.

Microsoft [Windows NT](#) kernels come in “checked” and “free” builds <sup>130</sup>.

The first has validation checks (hence, “checked”), the second one doesn’t (hence, “free” of checks).

Of course, “checked” kernel works slower because of all these checks, so it is usually used only in debug sessions.

## Accessing specific character

An array of pointers to strings can be accessed like this:

```

#include <stdio.h>

const char* month[]=
{
    "January", "February", "March", "April",
    "May", "June", "July", "August",
    "September", "October", "November", "December"
};

int main()
{
    // 4th month, 5th character:
    printf ("%c\n", month[3][4]);
};

```

...since `month[3]` expression has a `const char*` type. And then, 5th character is taken from that expression by adding 4 bytes to its address.

By the way, arguments list passed to `main()` function has the same data type:

```

#include <stdio.h>

int main(int argc, char *argv[])
{
    printf ("3rd argument, 2nd character: %c\n", argv[3][1]);
};

```

It’s very important to understand, that, despite similar syntax, this is different from two-dimensional arrays, which we will consider later.

<sup>130</sup>[msdn.microsoft.com/en-us/library/windows/hardware/ff543450\(v=vs.85\).aspx](https://msdn.microsoft.com/en-us/library/windows/hardware/ff543450(v=vs.85).aspx)

Another important thing to notice: strings to be addressed must be encoded in a system, where each character occupies single byte, like [ASCII<sup>131</sup>](#) and extended [ASCII](#). UTF-8 wouldn't work here.

### 1.26.6 Multidimensional arrays

Internally, a multidimensional array is essentially the same thing as a linear array.

Since the computer memory is linear, it is an one-dimensional array. For convenience, this multi-dimensional array can be easily represented as one-dimensional.

For example, this is how the elements of the 3x4 array are placed in one-dimensional array of 12 cells:

Offset in memory	array element
0	[0][0]
1	[0][1]
2	[0][2]
3	[0][3]
4	[1][0]
5	[1][1]
6	[1][2]
7	[1][3]
8	[2][0]
9	[2][1]
10	[2][2]
11	[2][3]

Table 1.3: Two-dimensional array represented in memory as one-dimensional

Here is how each cell of 3\*4 array are placed in memory:

0	1	2	3
4	5	6	7
8	9	10	11

Table 1.4: Memory addresses of each cell of two-dimensional array

So, in order to calculate the address of the element we need, we first multiply the first index by 4 (array width) and then add the second index. That's called *row-major order*, and this method of array and matrix representation is used in at least C/C++ and Python. The term *row-major order* in plain English language means: "first, write the elements of the first row, then the second row ...and finally the elements of the last row".

Another method for representation is called *column-major order* (the array indices are used in reverse order) and it is used at least in Fortran, MATLAB and R. *column-major order* term in plain English language means: "first, write the elements of the first column, then the second column ...and finally the elements of the last column".

Which method is better?

In general, in terms of performance and cache memory, the best scheme for data organization is the one, in which the elements are accessed sequentially.

So if your function accesses data per row, *row-major order* is better, and vice versa.

#### Two-dimensional array example

We are going to work with an array of type *char*, which implies that each element requires only one byte in memory.

#### Row filling example

Let's fill the second row with these values 0..3:

<sup>131</sup>American Standard Code for Information Interchange

Listing 1.248: Row filling example

```
#include <stdio.h>

char a[3][4];

int main()
{
    int x, y;

    // clear array
    for (x=0; x<3; x++)
        for (y=0; y<4; y++)
            a[x][y]=0;

    // fill second row by 0..3:
    for (y=0; y<4; y++)
        a[1][y]=y;
};
```

All three rows are marked with red. We see that second row now has values 0, 1, 2 and 3:

Address	Hex dump
00C33370	00 00 00 00 00 01 02 03 00 00 00 00 00 00 00 00
00C33380	02 00 00 00 C3 66 47 4E C3 66 47 4E 00 00 00 00
00C33390	00 00 00 00 00 00 00 00 00 00 00 00 00 00 00 00
00C333A0	00 00 00 00 00 00 00 00 00 00 00 00 00 00 00 00
00C333B0	00 00 00 00 00 00 00 00 00 00 00 00 00 00 00 00

Figure 1.93: OllyDbg: array is filled

### Column filling example

Let's fill the third column with values: 0..2:

Listing 1.249: Column filling example

```
#include <stdio.h>

char a[3][4];

int main()
{
    int x, y;

    // clear array
    for (x=0; x<3; x++)
        for (y=0; y<4; y++)
            a[x][y]=0;

    // fill third column by 0..2:
    for (x=0; x<3; x++)
        a[x][2]=x;
};
```

The three rows are also marked in red here.

We see that in each row, at third position these values are written: 0, 1 and 2.

Address	Hex dump
01033380	00 00 00 00 00 00 01 00 00 00 02 00 02 00 00 00
01033390	00 00 00 00 1E 44 EF 31 1E 44 EF 31 00 00 00 00
010333A0	00 00 00 00 00 00 00 00 00 00 00 00 00 00 00 00
010333B0	00 00 00 00 00 00 00 00 00 00 00 00 00 00 00 00

Figure 1.94: OllyDbg: array is filled

### Access two-dimensional array as one-dimensional

We can be easily assured that it's possible to access a two-dimensional array as one-dimensional array in at least two ways:

```

#include <stdio.h>

char a[3][4];

char get_by_coordinates1 (char array[3][4], int a, int b)
{
    return array[a][b];
};

char get_by_coordinates2 (char *array, int a, int b)
{
    // treat input array as one-dimensional
    // 4 is array width here
    return array[a*4+b];
};

char get_by_coordinates3 (char *array, int a, int b)
{
    // treat input array as pointer,
    // calculate address, get value at it
    // 4 is array width here
    return *(array+a*4+b);
};

int main()
{
    a[2][3]=123;
    printf ("%d\n", get_by_coordinates1(a, 2, 3));
    printf ("%d\n", get_by_coordinates2(a, 2, 3));
    printf ("%d\n", get_by_coordinates3(a, 2, 3));
};

```

Compile<sup>132</sup> and run it: it shows correct values.

What MSVC 2013 did is fascinating, all three routines are just the same!

Listing 1.250: Optimizing MSVC 2013 x64

```

array$ = 8
a$ = 16
b$ = 24
get_by_coordinates3 PROC
; RCX=address of array
; RDX=a
; R8=b
    movsxd rax, r8d
; EAX=b
    movsxd r9, edx
; R9=a
    add rax, rcx
; RAX=b+address of array
    movzx eax, BYTE PTR [rax+r9*4]
; AL=load byte at address RAX+R9*4=b+address of array+a*4=address of array+a*4+b
    ret 0
get_by_coordinates3 ENDP

array$ = 8
a$ = 16
b$ = 24
get_by_coordinates2 PROC
    movsxd rax, r8d
    movsxd r9, edx
    add rax, rcx
    movzx eax, BYTE PTR [rax+r9*4]
    ret 0
get_by_coordinates2 ENDP

array$ = 8

```

<sup>132</sup>This program is to be compiled as a C program, not C++, save it to a file with .c extension to compile it using MSVC



```

a$ = 16
b$ = 24
get_by_coordinates1 PROC
    movsxd  rax, r8d
    movsxd  r9,  edx
    add     rax, rcx
    movzx   eax, BYTE PTR [rax+r9*4]
    ret     0
get_by_coordinates1 ENDP

```

GCC also generates equivalent routines, but slightly different:

Listing 1.251: Optimizing GCC 4.9 x64

```

; RDI=address of array
; RSI=a
; RDX=b

get_by_coordinates1:
; sign-extend input 32-bit int values "a" and "b" to 64-bit ones
    movsx   rsi, esi
    movsx   rdx, edx
    lea    rax, [rdi+rsi*4]
; RAX=RDI+RSI*4=address of array+a*4
    movzx   eax, BYTE PTR [rax+rdx]
; AL=load byte at address RAX+RDX=address of array+a*4+b
    ret

get_by_coordinates2:
    lea    eax, [rdx+rsi*4]
; RAX=RDX+RSI*4=b+a*4
    cdqe
    movzx   eax, BYTE PTR [rdi+rax]
; AL=load byte at address RDI+RAX=address of array+b+a*4
    ret

get_by_coordinates3:
    sal    esi, 2
; ESI=a<<2=a*4
; sign-extend input 32-bit int values "a*4" and "b" to 64-bit ones
    movsx   rdx, edx
    movsx   rsi, esi
    add    rdi, rsi
; RDI=RDI+RSI=address of array+a*4
    movzx   eax, BYTE PTR [rdi+rdx]
; AL=load byte at address RDI+RDX=address of array+a*4+b
    ret

```

### Three-dimensional array example

It's the same for multidimensional arrays.

Now we are going to work with an array of type *int*: each element requires 4 bytes in memory.

Let's see:

Listing 1.252: simple example

```

#include <stdio.h>

int a[10][20][30];

void insert(int x, int y, int z, int value)
{
    a[x][y][z]=value;
};

```

We get (MSVC 2010):

Listing 1.253: MSVC 2010

```

_DATA    SEGMENT
COMM    _a:DWORD:01770H
_DATA    ENDS
PUBLIC  _insert
_TEXT   SEGMENT
_x$ = 8           ; size = 4
_y$ = 12          ; size = 4
_z$ = 16          ; size = 4
_value$ = 20      ; size = 4
_insert PROC
    push    ebp
    mov     ebp, esp
    mov     eax, DWORD PTR _x$[ebp]
    imul   eax, 2400           ; eax=600*4*x
    mov     ecx, DWORD PTR _y$[ebp]
    imul   ecx, 120           ; ecx=30*4*y
    lea    edx, DWORD PTR _a[eax+ecx] ; edx=a + 600*4*x + 30*4*y
    mov     eax, DWORD PTR _z$[ebp]
    mov     ecx, DWORD PTR _value$[ebp]
    mov     DWORD PTR [edx+eax*4], ecx ; *(edx+z*4)=value
    pop     ebp
    ret     0
_insert   ENDP
_TEXT    ENDS

```

Nothing special. For index calculation, three input arguments are used in the formula  $address = 600 \cdot 4 \cdot x + 30 \cdot 4 \cdot y + 4z$ , to represent the array as multidimensional. Do not forget that the *int* type is 32-bit (4 bytes), so all coefficients must be multiplied by 4.

Listing 1.254: GCC 4.4.1

```

insert    public insert
insert    proc near

x         = dword ptr 8
y         = dword ptr 0Ch
z         = dword ptr 10h
value    = dword ptr 14h

    push    ebp
    mov     ebp, esp
    push    ebx
    mov     ebx, [ebp+x]
    mov     eax, [ebp+y]
    mov     ecx, [ebp+z]
    lea    edx, [eax+eax] ; edx=y*2
    mov     eax, edx ; eax=y*2
    shl    eax, 4 ; eax=(y*2)<<4 = y*2*16 = y*32
    sub    eax, edx ; eax=y*32 - y*2=y*30
    imul   edx, ebx, 600 ; edx=x*600
    add    eax, edx ; eax=eax+edx=y*30 + x*600
    lea    edx, [eax+ecx] ; edx=y*30 + x*600 + z
    mov     eax, [ebp+value]
    mov     dword ptr ds:a[edx*4], eax ; *(a+edx*4)=value
    pop     ebx
    pop     ebp
    retn
insert    endp

```

The GCC compiler does it differently.

For one of the operations in the calculation ( $30y$ ), GCC produces code without multiplication instructions. This is how it does:  $(y + y) \ll 4 - (y + y) = (2y) \ll 4 - 2y = 2 \cdot 16 \cdot y - 2y = 32y - 2y = 30y$ . Thus, for the  $30y$  calculation, only one addition operation, one bitwise shift operation and one subtraction operation are used. This works faster.

## ARM + Non-optimizing Xcode 4.6.3 (LLVM) (Thumb mode)

Listing 1.255: Non-optimizing Xcode 4.6.3 (LLVM) (Thumb mode)

```
_insert
value = -0x10
z      = -0xC
y      = -8
x      = -4

; allocate place in local stack for 4 values of int type
SUB    SP, SP, #0x10
MOV    R9, 0xFC2 ; a
ADD    R9, PC
LDR.W  R9, [R9] ; get pointer to array
STR    R0, [SP,#0x10+x]
STR    R1, [SP,#0x10+y]
STR    R2, [SP,#0x10+z]
STR    R3, [SP,#0x10+value]
LDR    R0, [SP,#0x10+value]
LDR    R1, [SP,#0x10+z]
LDR    R2, [SP,#0x10+y]
LDR    R3, [SP,#0x10+x]
MOV    R12, 2400
MUL.W  R3, R3, R12
ADD    R3, R9
MOV    R9, 120
MUL.W  R2, R2, R9
ADD    R2, R3
LSLS   R1, R1, #2 ; R1=R1<<2
ADD    R1, R2
STR    R0, [R1] ; R1 - address of array element
; deallocate chunk in local stack, allocated for 4 values of int type
ADD    SP, SP, #0x10
BX     LR
```

Non-optimizing LLVM saves all variables in local stack, which is redundant.

The address of the array element is calculated by the formula we already saw.

## ARM + Optimizing Xcode 4.6.3 (LLVM) (Thumb mode)

Listing 1.256: Optimizing Xcode 4.6.3 (LLVM) (Thumb mode)

```
_insert
MOVW   R9, #0x10FC
MOV.W  R12, #2400
MOVT.W R9, #0
RSB.W  R1, R1, R1, LSL#4 ; R1 - y. R1=y<<4 - y = y*16 - y = y*15
ADD    R9, PC
LDR.W  R9, [R9] ; R9 = pointer to an array
MLA.W  R0, R0, R12, R9 ; R0 - x, R12 - 2400, R9 - pointer to a. R0=x*2400 + ptr to a
ADD.W  R0, R0, R1, LSL#3 ; R0 = R0+R1<<3 = R0+R1*8 = x*2400 + ptr to a + y*15*8 =
; ptr to a + y*30*4 + x*600*4
STR.W  R3, [R0,R2,LSL#2] ; R2 - z, R3 - value. address=R0+z*4 =
; ptr to a + y*30*4 + x*600*4 + z*4
BX     LR
```

The tricks for replacing multiplication by shift, addition and subtraction which we already saw are also present here.

Here we also see a new instruction for us: RSB (*Reverse Subtract*).

It works just as SUB, but it swaps its operands with each other before execution. Why? SUB and RSB are instructions, to the second operand of which shift coefficient may be applied: (LSL#4).

But this coefficient can be applied only to second operand.

That's fine for commutative operations like addition or multiplication (operands may be swapped there without changing the result).

But subtraction is a non-commutative operation, so RSB exist for these cases.

## MIPS

My example is tiny, so the GCC compiler decided to put the *a* array into the 64KiB area addressable by the Global Pointer.

Listing 1.257: Optimizing GCC 4.4.5 (IDA)

```
insert:
; $a0=x
; $a1=y
; $a2=z
; $a3=value
        sll    $v0, $a0, 5
; $v0 = $a0<<5 = x*32
        sll    $a0, 3
; $a0 = $a0<<3 = x*8
        addu   $a0, $v0
; $a0 = $a0+$v0 = x*8+x*32 = x*40
        sll    $v1, $a1, 5
; $v1 = $a1<<5 = y*32
        sll    $v0, $a0, 4
; $v0 = $a0<<4 = x*40*16 = x*640
        sll    $a1, 1
; $a1 = $a1<<1 = y*2
        subu   $a1, $v1, $a1
; $a1 = $v1-$a1 = y*32-y*2 = y*30
        subu   $a0, $v0, $a0
; $a0 = $v0-$a0 = x*640-x*40 = x*600
        la    $gp, __gnu_local_gp
        addu   $a0, $a1, $a0
; $a0 = $a1+$a0 = y*30+x*600
        addu   $a0, $a2
; $a0 = $a0+$a2 = y*30+x*600+z
; load address of table:
        lw    $v0, (a & 0xFFFF)($gp)
; multiply index by 4 to seek array element:
        sll    $a0, 2
; sum up multiplied index and table address:
        addu   $a0, $v0, $a0
; store value into table and return:
        jr    $ra
        sw    $a3, 0($a0)

        .comm a:0x1770
```

## Getting dimensions of multidimensional array

Any string processing function, if an array of characters passed to it, can't deduce a size of the input array. Likewise, if a function processes 2D array, only one dimension can be deduced.

For example:

```
int get_element(int array[10][20], int x, int y)
{
    return array[x][y];
};

int main()
{
    int array[10][20];

    get_element(array, 4, 5);
};
```

... if compiled (by any compiler) and then decompiled by Hex-Rays:

```
int get_element(int *array, int x, int y)
{
    return array[20 * x + y];
}
```

There is no way to find a size of the first dimension. If  $x$  value passed is too big, buffer overflow would occur, an element from some random place of memory would be read.

And 3D array:

```
int get_element(int array[10][20][30], int x, int y, int z)
{
    return array[x][y][z];
};

int main()
{
    int array[10][20][30];

    get_element(array, 4, 5, 6);
};
```

Hex-Rays:

```
int get_element(int *array, int x, int y, int z)
{
    return array[600 * x + z + 30 * y];
}
```

Again, sizes of only two of 3 dimensions can be deduced.

## More examples

The computer screen is represented as a 2D array, but the video-buffer is a linear 1D array. We talk about it here: [8.15.2 on page 905](#).

Another example in this book is Minesweeper game: it's field is also two-dimensional array: [8.4 on page 805](#).

### 1.26.7 Pack of strings as a two-dimensional array

Let's revisit the function that returns the name of a month: [listing.1.236](#).

As you see, at least one memory load operation is needed to prepare a pointer to the string that's the month's name.

Is it possible to get rid of this memory load operation?

In fact yes, if you represent the list of strings as a two-dimensional array:

```
#include <stdio.h>
#include <assert.h>

const char month2[12][10]=
{
    { 'J','a','n','u','a','r','y', 0, 0, 0 },
    { 'F','e','b','r','u','a','r','y', 0, 0 },
    { 'M','a','r','c','h', 0, 0, 0, 0, 0 },
    { 'A','p','r','i','l', 0, 0, 0, 0, 0 },
    { 'M','a','y', 0, 0, 0, 0, 0, 0 },
    { 'J','u','n','e', 0, 0, 0, 0, 0 },
    { 'J','u','l','y', 0, 0, 0, 0, 0 },
    { 'A','u','g','u','s','t', 0, 0, 0, 0 },
    { 'S','e','p','t','e','m','b','e','r', 0 },
    { 'O','c','t','o','b','e','r', 0, 0, 0 },
    { 'N','o','v','e','m','b','e','r', 0, 0 },
    { 'D','e','c','e','m','b','e','r', 0, 0 }
};
```

```
// in 0..11 range
const char* get_month2 (int month)
{
    return &month2[month][0];
};
```

Here is what we've get:

Listing 1.258: Optimizing MSVC 2013 x64

```
month2 DB 04aH
        DB 061H
        DB 06eH
        DB 075H
        DB 061H
        DB 072H
        DB 079H
        DB 00H
        DB 00H
        DB 00H
...
get_month2 PROC
; sign-extend input argument and promote to 64-bit value
    movsxd rax, ecx
    lea rcx, QWORD PTR [rax+rax*4]
; RCX=month*4=month*5
    lea rax, OFFSET FLAT:month2
; RAX=pointer to table
    lea rax, QWORD PTR [rax+rcx*2]
; RAX=pointer to table + RCX*2=pointer to table + month*5*2=pointer to table + month*10
    ret 0
get_month2 ENDP
```

There are no memory accesses at all.

All this function does is to calculate a point at which the first character of the name of the month is: *pointer\_to\_the\_table + month \* 10*.

There are also two LEA instructions, which effectively work as several MUL and MOV instructions.

The width of the array is 10 bytes.

Indeed, the longest string here—"September"—is 9 bytes, and plus the terminating zero is 10 bytes.

The rest of the month names are padded by zero bytes, so they all occupy the same space (10 bytes).

Thus, our function works even faster, because all string start at an address which can be calculated easily.

Optimizing GCC 4.9 can do it even shorter:

Listing 1.259: Optimizing GCC 4.9 x64

```
movsx rdi, edi
lea rax, [rdi+rdi*4]
lea rax, month2[rax+rax]
ret
```

LEA is also used here for multiplication by 10.

Non-optimizing compilers do multiplication differently.

Listing 1.260: Non-optimizing GCC 4.9 x64

```
get_month2:
    push rbp
    mov rbp, rsp
    mov DWORD PTR [rbp-4], edi
    mov eax, DWORD PTR [rbp-4]
    movsx rdx, eax
; RDX = sign-extended input value
```

```

    mov    rax, rdx
; RAX = month
    sal   rax, 2
; RAX = month<<2 = month*4
    add   rax, rdx
; RAX = RAX+RDX = month*4+month = month*5
    add   rax, rax
; RAX = RAX*2 = month*5*2 = month*10
    add   rax, OFFSET FLAT:month2
; RAX = month*10 + pointer to the table
    pop   rbp
    ret

```

Non-optimizing MSVC just uses IMUL instruction:

Listing 1.261: Non-optimizing MSVC 2013 x64

```

month$ = 8
get_month2 PROC
    mov    DWORD PTR [rsp+8], ecx
    movsxd rax, DWORD PTR month$[rsp]
; RAX = sign-extended input value into 64-bit one
    imul  rax, rax, 10
; RAX = RAX*10
    lea   rcx, OFFSET FLAT:month2
; RCX = pointer to the table
    add   rcx, rax
; RCX = RCX+RAX = pointer to the table+month*10
    mov   rax, rcx
; RAX = pointer to the table+month*10
    mov   ecx, 1
; RCX = 1
    imul  rcx, rcx, 0
; RCX = 1*0 = 0
    add   rax, rcx
; RAX = pointer to the table+month*10 + 0 = pointer to the table+month*10
    ret   0
get_month2 ENDP

```

But one thing is weird here: why add multiplication by zero and adding zero to the final result?

This looks like a compiler code generator quirk, which wasn't caught by the compiler's tests (the resulting code works correctly, after all). We intentionally consider such pieces of code so the reader would understand, that sometimes one shouldn't puzzle over such compiler artifacts.

### 32-bit ARM

Optimizing Keil for Thumb mode uses the multiplication instruction MULS:

Listing 1.262: Optimizing Keil 6/2013 (Thumb mode)

```

; R0 = month
    MOVS   r1, #0xa
; R1 = 10
    MULS   r0, r1, r0
; R0 = R1*R0 = 10*month
    LDR    r1, |L0.68|
; R1 = pointer to the table
    ADDS   r0, r0, r1
; R0 = R0+R1 = 10*month + pointer to the table
    BX    lr

```

Optimizing Keil for ARM mode uses add and shift operations:

Listing 1.263: Optimizing Keil 6/2013 (ARM mode)

```

; R0 = month
    LDR    r1, |L0.104|
; R1 = pointer to the table
    ADD    r0, r0, r0, LSL #2
; R0 = R0+R0<<2 = R0+R0*4 = month*5

```

```

    ADD    r0,r1,r0,LSL #1
; R0 = R1+R0<<2 = pointer to the table + month*5*2 = pointer to the table + month*10
    BX    lr

```

## ARM64

Listing 1.264: Optimizing GCC 4.9 ARM64

```

; W0 = month
    sxtw   x0, w0
; X0 = sign-extended input value
    adrp  x1, .LANCHOR1
    add   x1, x1, :lo12:.LANCHOR1
; X1 = pointer to the table
    add   x0, x0, x0, lsl 2
; X0 = X0+X0<<2 = X0+X0*4 = X0*5
    add   x0, x1, x0, lsl 1
; X0 = X1+X0<<1 = X1+X0*2 = pointer to the table + X0*10
    ret

```

SXTW is used for sign-extension and promoting input 32-bit value into a 64-bit one and storing it in X0.

ADRP/ADD pair is used for loading the address of the table.

The ADD instructions also has a LSL suffix, which helps with multiplications.

## MIPS

Listing 1.265: Optimizing GCC 4.4.5 (IDA)

```

                .globl get_month2
get_month2:
; $a0=month
    sll    $v0, $a0, 3
; $v0 = $a0<<3 = month*8
    sll    $a0, 1
; $a0 = $a0<<1 = month*2
    addu   $a0, $v0
; $a0 = month*2+month*8 = month*10
; load address of the table:
    la     $v0, month2
; sum up table address and index we calculated and return:
    jr     $ra
    addu   $v0, $a0

month2:
    .ascii "January"<0>
    .byte 0, 0
aFebruary:
    .ascii "February"<0>
    .byte 0
aMarch:
    .ascii "March"<0>
    .byte 0, 0, 0, 0
aApril:
    .ascii "April"<0>
    .byte 0, 0, 0, 0
aMay:
    .ascii "May"<0>
    .byte 0, 0, 0, 0, 0, 0
aJune:
    .ascii "June"<0>
    .byte 0, 0, 0, 0, 0
aJuly:
    .ascii "July"<0>
    .byte 0, 0, 0, 0, 0
aAugust:
    .ascii "August"<0>
    .byte 0, 0, 0
aSeptember:
    .ascii "September"<0>
aOctober:
    .ascii "October"<0>
    .byte 0, 0
aNovember:
    .ascii "November"<0>
    .byte 0
aDecember:
    .ascii "December"<0>
    .byte 0, 0, 0, 0, 0, 0, 0, 0, 0, 0

```



## Conclusion

This is a bit old-school technique to store text strings. You may find a lot of it in Oracle RDBMS, for example. It's hard to say if it's worth doing on modern computers. Nevertheless, it is a good example of arrays, so it was added to this book.

### 1.26.8 Conclusion

An array is a pack of values in memory located adjacently.

It's true for any element type, including structures.

Access to a specific array element is just a calculation of its address.

So, a pointer to an array and address of a first element—is the same thing. This is why `ptr[0]` and `*ptr` expressions are equivalent in C/C++. It's interesting to note that Hex-Rays often replaces the first by the second. It does so when it have no idea that it works with pointer to the whole array, and thinks that this is a pointer to single variable.

### 1.26.9 Exercises

- <http://challenges.re/62>
- <http://challenges.re/63>
- <http://challenges.re/64>
- <http://challenges.re/65>
- <http://challenges.re/66>

## 1.27 Example: a bug in Angband

An ancient rogue-like game from 1990's <sup>133</sup> had a nice bug in the spirit of the "Roadside Picnic"<sup>134</sup> by Strugatsky brothers or "The Lost Room" TV series<sup>135</sup>:

The frog-knows version was abundant of bugs. The funniest of them led to a cunning technique of cheating the game, that was called "mushroom farming". If there were more than a certain number (about five hundred) of objects in the labyrinth, the game would break, and many old things turned into objects thrown to the floor. Accordingly, the player went into the maze, he made such longitudinal grooves there (with a special spell), and walked along the grooves, creating mushrooms with another special spell. When there were a lot of mushrooms, the player put and took, put and took some useful item, and mushrooms one by one turned into this subject. After that, the player returned with hundreds of copies of the useful item.

( Misha "tiphareth" Verbitsky, <http://imperium.lenin.ru/CEBEP/arc/3/lightmusic/light.htm> )

And some information from usenet:

From: be...@uswest.com (George Bell)  
Subject: [Angband] Multiple artifact copies found (bug?)  
Date: Fri, 23 Jul 1993 15:55:08 GMT

Up to 2000 ft I found only 4 artifacts, now my house is littered with the suckers (FYI, most I've gotten from killing nasties, like Dracoliches and the like). Something really weird is happening now, as I found multiple copies of the same artifact! My half-elf ranger is down at 2400 ft on one level which is particularly nasty. There is a graveyard plus monsters surrounded by permanent rock and 2 or 3 other special monster rooms! I did so much slashing with my favorite weapon, Crisdurian, that I filled several rooms nearly to the brim with treasure (as usual, mostly junk).

<sup>133</sup>[https://en.wikipedia.org/wiki/Angband\\_\(video\\_game\)](https://en.wikipedia.org/wiki/Angband_(video_game)), <http://rephial.org/>

<sup>134</sup>[https://en.wikipedia.org/wiki/Roadside\\_Picnic](https://en.wikipedia.org/wiki/Roadside_Picnic)

<sup>135</sup>[https://en.wikipedia.org/wiki/The\\_Lost\\_Room](https://en.wikipedia.org/wiki/The_Lost_Room)

Then, when I found a way into the big vault, I noticed some of the treasure had already been identified (in fact it looked strangely familiar!). Then I found \*two\* Short Swords named Sting (1d6) (+7,+8), and I just ran across a third copy! I have seen multiple copies of Gurthang on this level as well. Is there some limit on the number of items per level which I have exceeded? This sounds reasonable as all multiple copies I have seen come from this level.

I'm playing PC angband. Anybody else had this problem?

-George Bell

Help! I need a Rod of Restore Life Levels, if there is such a thing. These Graveyards are nasty (Black Reavers and some speed 2 wraith in particular).

( <https://groups.google.com/forum/#!original/rec.games.moria/jItmfrdGyL8/8csctQqA7PQJ> )

From: Ceri <cm...@andrew.cmu.edu>  
Subject: Re: [Angband] Multiple artifact copies found (bug?)  
Date: Fri, 23 Jul 1993 23:32:20 -0400

welcome to the mush bug. if there are more than 256 items on the floor, things start duplicating. learn to harness this power and you will win shortly :>

--Rick

( [https://groups.google.com/forum/#!search/angband\\$202.4\\$20bug\\$20multiplying\\$20items/rec.games.moria/jItmfrdGyL8/FoQeiccewHAJ](https://groups.google.com/forum/#!search/angband$202.4$20bug$20multiplying$20items/rec.games.moria/jItmfrdGyL8/FoQeiccewHAJ) )

From: nwe...@soda.berkeley.edu (Nicholas C. Weaver)  
Subject: Re: [Angband] Multiple artifact copies found (bug?)  
Date: 24 Jul 1993 18:18:05 GMT

In article <74348474...@unix1.andrew.cmu.edu> Ceri <cm...@andrew.cmu.edu> writes:  
>welcome to the mush bug. if there are more than 256 items  
>on the floor, things start duplicating. learn to harness  
>this power and you will win shortly :>  
>  
>--Rick

Question on this. Is it only the first 256 items which get duplicated? What about the original items? Etc Etc Etc...

Oh, for those who like to know about bugs, though, the -n option (start new character) has the following behavior:

(this is in version 2.4.Frog.knows on unix)

If you hit controll-p, you keep your old stats.

Y0u loose all record of artifacts founds and named monsters killed.

Y0u loose all items you are carrying (they get turned into error in objid(s) ).

You loose your gold.

You KEEP all the stuff in your house.

If you kill something, and then quaff a potion of restore life levels, you are back up to where you were before in EXPERIENCE POINTS!!

Gaining spells will not work right after this, unless you have a gain int item (for spellcasters) or gain wis item (for priests/palidans), in which case after performing the above, then take the item back on and off, you will be able to learn spells normally again.

This can be exploited, if you are a REAL H0ZER (like me), into getting multiple artifacts early on. Just get to a level where you can pound wormtongue into the ground, kill him, go up, drop your stuff in your house, buy a few potions of restore exp and high value spellbooks with your leftover gold, angband -n yourself back to what you were before, and repeat the process. Yes, you CAN kill wormtongue multiple times. :)

This also allows the creation of a human rogue with dunedain warrior starting stats.

Of course, such practices are evil, vile, and disgusting. I take no liability for the results of spreading this information. Yeah, it's another bug to go onto the pile.

```
--
Nicholas C. Weaver      perpetual ensign guppy      nwe...@soda.berkeley.edu
It is a tale, told by an idiot, full of sound and fury, .signifying nothing.
    Since C evolved out of B, and a C+ is close to a B,
    does that mean that C++ is a devolution of the language?
```

( <https://groups.google.com/forum/#!original/rec.games.moria/jItmfrdGyL8/FoQeiccewHAJ> )

The whole thread: [https://groups.google.com/forum/#!search/angband\\$202.4\\$20bug\\$20multiplying\\$20i/rec.games.moria/jItmfrdGyL8/FoQeiccewHAJ](https://groups.google.com/forum/#!search/angband$202.4$20bug$20multiplying$20i/rec.games.moria/jItmfrdGyL8/FoQeiccewHAJ).

The author of these lines has found the version with the bug (2.4 fk) <sup>136</sup>, and we can clearly see how the global arrays are declared:

```
/* Number of dungeon objects */
#define MAX_DUNGEON_OBJ  423

...

int16 sorted_objects[MAX_DUNGEON_OBJ];

/* Identified objects flags */
int8u object_ident[OBJECT_IDENT_SIZE];
int16 t_level[MAX_OBJ_LEVEL+1];
inven_type t_list[MAX_TALLOC];
inven_type inventory[INVEN_ARRAY_SIZE];
```

Perhaps this is a reason. The MAX\_DUNGEON\_OBJ constant is too small. Perhaps, authors should use linked lists or other data structures, which are unlimited by size. But arrays are simpler to use.

Another example of buffer overflow over globally defined arrays: [3.31 on page 643](#).

## 1.28 Manipulating specific bit(s)

A lot of functions define their input arguments as flags in bit fields.

Of course, they could be substituted by a set of *bool*-typed variables, but it is not frugally.

### 1.28.1 Specific bit checking

#### x86

Win32 API example:

```
HANDLE fh;

fh=CreateFile ("file", GENERIC_WRITE | GENERIC_READ, FILE_SHARE_READ, NULL, OPEN_ALWAYS,
↵ , FILE_ATTRIBUTE_NORMAL, NULL);
```

<sup>136</sup><http://rephial.org/release/2.4.fk>, <https://yurichev.com/mirrors/angband-2.4.fk.tar>

We get (MSVC 2010):

Listing 1.266: MSVC 2010

```
push    0
push    128          ; 00000080H
push    4
push    0
push    1
push    -1073741824 ; c0000000H
push    OFFSET $SG78813
call    DWORD PTR __imp__CreateFileA@28
mov     DWORD PTR _fh$[ebp], eax
```

Let's take a look in WinNT.h:

Listing 1.267: WinNT.h

```
#define GENERIC_READ          (0x80000000L)
#define GENERIC_WRITE        (0x40000000L)
#define GENERIC_EXECUTE      (0x20000000L)
#define GENERIC_ALL          (0x10000000L)
```

Everything is clear,  $\text{GENERIC\_READ} | \text{GENERIC\_WRITE} = 0x80000000 | 0x40000000 = 0xC0000000$ , and that value is used as the second argument for the `CreateFile()`<sup>137</sup> function.

How would `CreateFile()` check these flags?

If we look in `KERNEL32.DLL` in Windows XP SP3 x86, we'll find this fragment of code in `CreateFileW`:

Listing 1.268: `KERNEL32.DLL` (Windows XP SP3 x86)

```
.text:7C83D429    test    byte ptr [ebp+dwDesiredAccess+3], 40h
.text:7C83D42D    mov     [ebp+var_8], 1
.text:7C83D434    jz     short loc_7C83D417
.text:7C83D436    jmp    loc_7C810817
```

Here we see the `TEST` instruction, however it doesn't take the whole second argument, but only the most significant byte (`ebp+dwDesiredAccess+3`) and checks it for flag `0x40` (which implies the `GENERIC_WRITE` flag here).

`TEST` is basically the same instruction as `AND`, but without saving the result (recall the fact `CMP` is merely the same as `SUB`, but without saving the result ( 1.12.4 on page 87)).

The logic of this code fragment is as follows:

```
if ((dwDesiredAccess&0x40000000) == 0) goto loc_7C83D417
```

If `AND` instruction leaves this bit, the `ZF` flag is to be cleared and the `JZ` conditional jump is not to be triggered. The conditional jump is triggered only if the `0x40000000` bit is absent in `dwDesiredAccess` variable —then the result of `AND` is 0, `ZF` is to be set and the conditional jump is to be triggered.

Let's try `GCC 4.4.1` and Linux:

```
#include <stdio.h>
#include <fcntl.h>

void main()
{
    int handle;

    handle=open ("file", O_RDWR | O_CREAT);
};
```

<sup>137</sup>[msdn.microsoft.com/en-us/library/aa363858\(VS.85\).aspx](http://msdn.microsoft.com/en-us/library/aa363858(VS.85).aspx)

We get:

Listing 1.269: GCC 4.4.1

```
main          public main
              proc near

var_20        = dword ptr -20h
var_1C        = dword ptr -1Ch
var_4         = dword ptr -4

              push    ebp
              mov     ebp, esp
              and     esp, 0FFFFFFF0h
              sub     esp, 20h
              mov     [esp+20h+var_1C], 42h
              mov     [esp+20h+var_20], offset aFile ; "file"
              call   _open
              mov     [esp+20h+var_4], eax
              leave
              retn
main          endp
```

If we take a look in the `open()` function in the `libc.so.6` library, it is only a syscall:

Listing 1.270: `open()` (`libc.so.6`)

```
.text:000BE69B  mov     edx, [esp+4+mode] ; mode
.text:000BE69F  mov     ecx, [esp+4+flags] ; flags
.text:000BE6A3  mov     ebx, [esp+4+filename] ; filename
.text:000BE6A7  mov     eax, 5
.text:000BE6AC  int     80h                ; LINUX - sys_open
```

So, the bit fields for `open()` are apparently checked somewhere in the Linux kernel.

Of course, it is easy to download both Glibc and the Linux kernel source code, but we are interested in understanding the matter without it.

So, as of Linux 2.6, when the `sys_open` syscall is called, control eventually passes to `do_sys_open`, and from there—to the `do_filp_open()` function (it's located in the kernel source tree in `fs/namei.c`).

N.B. Aside from passing arguments via the stack, there is also a method of passing some of them via registers. This is also called `fastcall` ([6.1.3 on page 736](#)). This works faster since CPU does not need to access the stack in memory to read argument values. GCC has the option `regparm`<sup>138</sup>, through which it's possible to set the number of arguments that can be passed via registers.

The Linux 2.6 kernel is compiled with `-mregparm=3` option <sup>139 140</sup>.

What this means to us is that the first 3 arguments are to be passed via registers EAX, EDX and ECX, and the rest via the stack. Of course, if the number of arguments is less than 3, only part of registers set is to be used.

So, let's download Linux Kernel 2.6.31, compile it in Ubuntu: `make vmlinux`, open it in [IDA](#), and find the `do_filp_open()` function. At the beginning, we see (the comments are mine):

Listing 1.271: `do_filp_open()` (linux kernel 2.6.31)

```
do_filp_open  proc near
...
              push    ebp
              mov     ebp, esp
              push    edi
              push    esi
              push    ebx
              mov     ebx, ecx
              add     ebx, 1
              sub     esp, 98h
              mov     esi, [ebp+arg_4] ; acc_mode (5th argument)
              test    bl, 3
```

<sup>138</sup>[ohse.de/uwe/articles/gcc-attributes.html#func-regparm](http://ohse.de/uwe/articles/gcc-attributes.html#func-regparm)

<sup>139</sup>[kernelnewbies.org/Linux\\_2\\_6\\_20#head-042c62f290834eb1fe0a1942bbf5bb9a4accbc8f](http://kernelnewbies.org/Linux_2_6_20#head-042c62f290834eb1fe0a1942bbf5bb9a4accbc8f)

<sup>140</sup>See also `arch/x86/include/asm/calling.h` file in kernel tree

```

mov     [ebp+var_80], eax ; dfd (1th argument)
mov     [ebp+var_7C], edx ; pathname (2th argument)
mov     [ebp+var_78], ecx ; open_flag (3th argument)
jnz     short loc_C01EF684
mov     ebx, ecx          ; ebx <- open_flag

```

GCC saves the values of the first 3 arguments in the local stack. If that wasn't done, the compiler would not touch these registers, and that would be too tight environment for the compiler's [register allocator](#).

Let's find this fragment of code:

Listing 1.272: do\_filp\_open() (linux kernel 2.6.31)

```

loc_C01EF684:          ; CODE XREF: do_filp_open+4F
                test    bl, 40h          ; 0_CREAT
                jnz     loc_C01EF810
                mov     edi, ebx
                shr     edi, 11h
                xor     edi, 1
                and     edi, 1
                test   ebx, 10000h
                jz      short loc_C01EF6D3
                or      edi, 2

```

0x40—is what the `O_CREAT` macro equals to. `open_flag` gets checked for the presence of the 0x40 bit, and if this bit is 1, the next `JNZ` instruction is triggered.

## ARM

The `O_CREAT` bit is checked differently in Linux kernel 3.8.0.

Listing 1.273: linux kernel 3.8.0

```

struct file *do_filp_open(int dfd, struct filename *pathname,
                          const struct open_flags *op)
{
    ...
    filp = path_openat(dfd, pathname, &nd, op, flags | LOOKUP_RCU);
    ...
}

static struct file *path_openat(int dfd, struct filename *pathname,
                                struct nameidata *nd, const struct open_flags *op, int flags)
{
    ...
    error = do_last(nd, &path, file, op, &opened, pathname);
    ...
}

static int do_last(struct nameidata *nd, struct path *path,
                  struct file *file, const struct open_flags *op,
                  int *opened, struct filename *name)
{
    ...
    if (!(open_flag & O_CREAT)) {
        ...
        error = lookup_fast(nd, path, &inode);
        ...
    } else {
        ...
        error = complete_walk(nd);
    }
    ...
}

```

Here is how the kernel compiled for ARM mode looks in [IDA](#):

Listing 1.274: do\_last() from vmlinux (IDA)

```

...
.text:C0169EA8    MOV     R9, R3 ; R3 - (4th argument) open_flag
...
.text:C0169ED4    LDR     R6, [R9] ; R6 - open_flag
...
.text:C0169F68    TST     R6, #0x40 ; jumptable C0169F00 default case
.text:C0169F6C    BNE     loc_C016A128
.text:C0169F70    LDR     R2, [R4,#0x10]
.text:C0169F74    ADD     R12, R4, #8
.text:C0169F78    LDR     R3, [R4,#0xC]
.text:C0169F7C    MOV     R0, R4
.text:C0169F80    STR     R12, [R11,#var_50]
.text:C0169F84    LDRB   R3, [R2,R3]
.text:C0169F88    MOV     R2, R8
.text:C0169F8C    CMP     R3, #0
.text:C0169F90    ORRNE  R1, R1, #3
.text:C0169F94    STRNE  R1, [R4,#0x24]
.text:C0169F98    ANDS   R3, R6, #0x200000
.text:C0169F9C    MOV     R1, R12
.text:C0169FA0    LDRNE  R3, [R4,#0x24]
.text:C0169FA4    ANDNE  R3, R3, #1
.text:C0169FA8    EORNE  R3, R3, #1
.text:C0169FAC    STR     R3, [R11,#var_54]
.text:C0169FB0    SUB     R3, R11, #-var_38
.text:C0169FB4    BL     lookup_fast
...
.text:C016A128  loc_C016A128 ; CODE XREF: do_last.isra.14+DC
.text:C016A128    MOV     R0, R4
.text:C016A12C    BL     complete_walk
...

```

TST is analogous to the TEST instruction in x86. We can “spot” visually this code fragment by the fact the lookup\_fast() is to be executed in one case and complete\_walk() in the other. This corresponds to the source code of the do\_last() function. The 0\_CREAT macro equals to 0x40 here too.

## 1.28.2 Setting and clearing specific bits

For example:

```

#include <stdio.h>

#define IS_SET(flag, bit)      ((flag) & (bit))
#define SET_BIT(var, bit)     ((var) |= (bit))
#define REMOVE_BIT(var, bit)  ((var) &= ~(bit))

int f(int a)
{
    int rt=a;

    SET_BIT (rt, 0x4000);
    REMOVE_BIT (rt, 0x200);

    return rt;
};

int main()
{
    f(0x12340678);
};

```

### x86

#### Non-optimizing MSVC

We get (MSVC 2010):

Listing 1.275: MSVC 2010

```

_rt$ = -4          ; size = 4
_a$ = 8           ; size = 4
_f PROC
    push    ebp
    mov     ebp, esp
    push    ecx
    mov     eax, DWORD PTR _a$[ebp]
    mov     DWORD PTR _rt$[ebp], eax
    mov     ecx, DWORD PTR _rt$[ebp]
    or      ecx, 16384          ; 00004000H
    mov     DWORD PTR _rt$[ebp], ecx
    mov     edx, DWORD PTR _rt$[ebp]
    and     edx, -513          ; fffffdffH
    mov     DWORD PTR _rt$[ebp], edx
    mov     eax, DWORD PTR _rt$[ebp]
    mov     esp, ebp
    pop     ebp
    ret     0
_f ENDP

```

The OR instruction sets one bit into a register while ignoring other 1 bits.

AND resets one bit. It can be said that AND just copies all bits except one. Indeed, in the second AND operand only the bits that need to be saved are set, just the one do not want to copy is not (which is 0 in the bitmask). It is the easier way to memorize the logic.



# OllyDbg

Let's try this example in OllyDbg.

First, let's see the binary form of the constants we are going to use:

0x200 (0b000000000000000000100000000) (i.e., the 10th bit (counting from 1st)).

Inverted 0x200 is 0xFFFFDFF (0b11111111111111111110111111111).

0x4000 (0b00000000000000100000000000000) (i.e., the 15th bit).

The input value is: 0x12340678 (0b1001000110100000011001111000). We see how it's loaded:

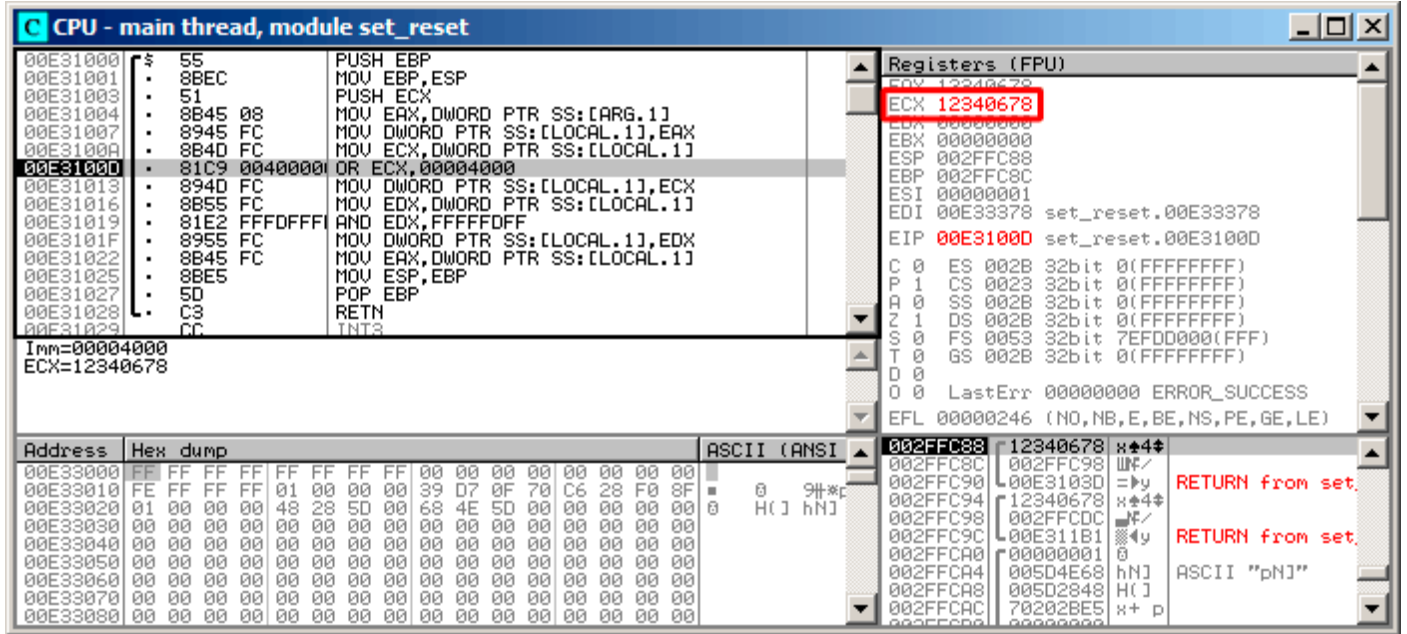

Figure 1.95: OllyDbg: value is loaded into ECX

OR got executed:

The screenshot shows the CPU window for the main thread in the 'set\_reset' module. The assembly code is as follows:

```

00E31000 55      PUSH EBP
00E31001 8BEC   MOV EBP,ESP
00E31003 51     PUSH ECX
00E31004 8B45 08 MOV EAX,DWORD PTR SS:[ARG.1]
00E31007 8945 FC MOV DWORD PTR SS:[LOCAL.1],EAX
00E3100A 8B4D FC MOV ECX,DWORD PTR SS:[LOCAL.1]
00E3100D 81C9 00400000 OR ECX,00004000
00E31013 894D FC MOV DWORD PTR SS:[LOCAL.1],ECX
00E31016 8B55 FC MOV EDX,DWORD PTR SS:[LOCAL.1]
00E31019 81E2 FFFDFFF AND EDX,FFFFFFF
00E3101F 8955 FC MOV DWORD PTR SS:[LOCAL.1],EDX
00E31022 8B45 FC MOV EAX,DWORD PTR SS:[LOCAL.1]
00E31025 8BE5   MOV ESP,EBP
00E31027 5D     POP EBP
00E31028 C3     RETN
00E31029 CC     INT3
  
```

The Registers (FPU) window shows the following values:

```

ECX 12344678
EDX 00000000
EBX 00000000
ESP 002FFC88
EBP 002FFC8C
ESI 00000001
EDI 00E33378 set_reset.00E33378
EIP 00E31013 set_reset.00E31013
  
```

The Stack window shows the following data:

```

Address Hex dump ASCII (ANSI)
00E33000 FF FF FF FF FF FF FF 00 00 00 00 00 00 00 00
00E33010 FE FF FF FF 01 00 00 00 39 07 0F 70 C6 28 F0 8F
00E33020 01 00 00 00 48 28 5D 00 68 4E 5D 00 00 00 00 00
00E33030 00 00 00 00 00 00 00 00 00 00 00 00 00 00 00
00E33040 00 00 00 00 00 00 00 00 00 00 00 00 00 00 00
00E33050 00 00 00 00 00 00 00 00 00 00 00 00 00 00 00
00E33060 00 00 00 00 00 00 00 00 00 00 00 00 00 00 00
00E33070 00 00 00 00 00 00 00 00 00 00 00 00 00 00 00
00E33080 00 00 00 00 00 00 00 00 00 00 00 00 00 00 00
  
```

Figure 1.96: OllyDbg: OR executed

15th bit is set: 0x12344678 (0b10010001101000100011001111000).

The value is reloaded again (because the compiler is not in optimizing mode):

**CPU - main thread, module set\_reset**

Address	Hex dump	ASCII (ANSI)
00E31000	55	
00E31001	8BEC	
00E31003	51	
00E31004	8B45 08	
00E31007	8945 FC	
00E3100A	8B4D FC	
00E3100D	81C9 00400000	
00E31013	894D FC	
00E31016	8B55 FC	
00E31019	81E2 FFFFFFFF	
00E3101F	8955 FC	
00E31022	8B45 FC	
00E31025	8B55 FC	
00E31027	5D	
00E31028	C3	
00E31029	CC	

Imm=FFFFFFF  
EDX=12344678

**Registers (FPU)**

EAX	12340678
ECX	12344678
<b>EDX</b>	<b>12344678</b>
EBX	00000000
ESP	002FFC88
EBP	002FFC8C
ESI	00000001
EDI	00E33378 set_reset.00E33378
EIP	00E31019 set_reset.00E31019

**002FFC88** 12344678 xF4

002FFC8C 002FFC98 xF4  
002FFC90 00E3103D => RETURN from set.  
002FFC94 12340678 x\*4  
002FFC98 002FFCDC xF4  
002FFC9C 00E311B1 xF4  
002FFCA0 00000001 0  
002FFCA4 005D4E68 hNJ ASCII "pNJ"  
002FFCA8 005D2848 H(J  
002FFCAC 70202BE5 x+ p

Figure 1.97: OllyDbg: value has been reloaded into EDX

AND got executed:

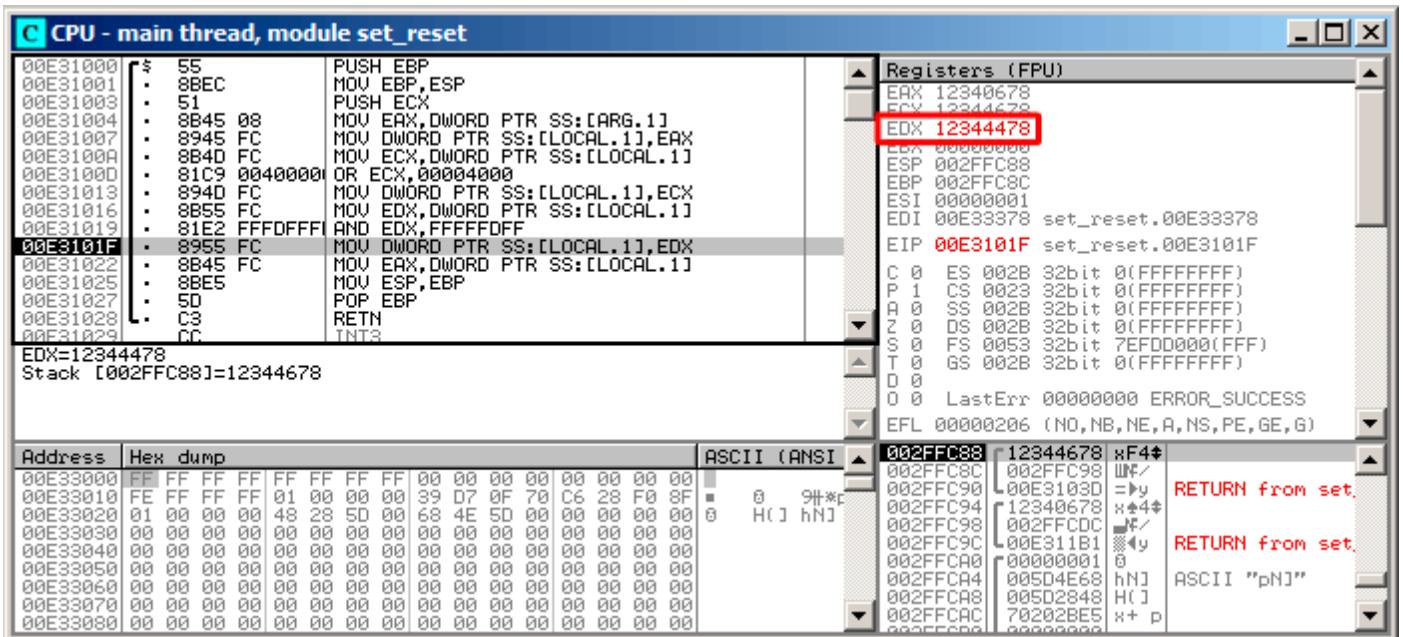

Figure 1.98: OllyDbg: AND executed

The 10th bit has been cleared (or, in other words, all bits were left except the 10th) and the final value now is 0x12344478 (0b10010001101000100010001111000).

## Optimizing MSVC

If we compile it in MSVC with optimization turned on (/Ox), the code is even shorter:

Listing 1.276: Optimizing MSVC

```

_a$ = 8 ; size = 4
_f PROC
    mov     eax, DWORD PTR _a$[esp-4]
    and     eax, -513 ; ffffffffh
    or      eax, 16384 ; 00004000h
    ret     0
_f ENDP

```

## Non-optimizing GCC

Let's try GCC 4.4.1 without optimization:

Listing 1.277: Non-optimizing GCC

```

f
    public f
    proc near

var_4 = dword ptr -4
arg_0 = dword ptr 8

    push    ebp
    mov     ebp, esp
    sub     esp, 10h
    mov     eax, [ebp+arg_0]
    mov     [ebp+var_4], eax
    or     [ebp+var_4], 4000h
    and    [ebp+var_4], 0FFFFFFFh
    mov     eax, [ebp+var_4]
    leave

```

```
f      retn
      endp
```

There is a redundant code present, however, it is shorter than the MSVC version without optimization. Now let's try GCC with optimization turned on -O3:

## Optimizing GCC

Listing 1.278: Optimizing GCC

```
f      public f
      proc near
arg_0  = dword ptr 8

      push    ebp
      mov     ebp, esp
      mov     eax, [ebp+arg_0]
      pop     ebp
      or      ah, 40h
      and     ah, 0FDh
      retn
f      endp
```

That's shorter. It is worth noting the compiler works with the EAX register part via the AH register—that is the EAX register part from the 8th to the 15th bits included.

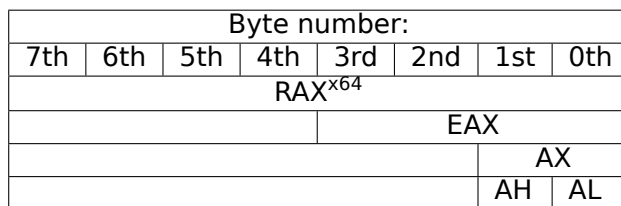

N.B. The 16-bit CPU 8086 accumulator was named AX and consisted of two 8-bit halves—AL (lower byte) and AH (higher byte). In 80386 almost all registers were extended to 32-bit, the accumulator was named EAX, but for the sake of compatibility, its *older parts* may be still accessed as AX/AH/AL.

Since all x86 CPUs are successors of the 16-bit 8086 CPU, these *older* 16-bit opcodes are shorter than the newer 32-bit ones. That's why the `or ah, 40h` instruction occupies only 3 bytes. It would be more logical way to emit here `or eax, 04000h` but that is 5 bytes, or even 6 (in case the register in the first operand is not EAX).

## Optimizing GCC and regparm

It would be even shorter if to turn on the -O3 optimization flag and also set `regparm=3`.

Listing 1.279: Optimizing GCC

```
f      public f
      proc near
      push    ebp
      or      ah, 40h
      mov     ebp, esp
      and     ah, 0FDh
      pop     ebp
      retn
f      endp
```

Indeed, the first argument is already loaded in EAX, so it is possible to work with it in-place. It is worth noting that both the function prologue (`push ebp / mov ebp, esp`) and epilogue (`pop ebp`) can easily be omitted here, but GCC probably is not good enough to do such code size optimizations. However, such short functions are better to be *inlined functions* ([3.14 on page 510](#)).

## ARM + Optimizing Keil 6/2013 (ARM mode)

Listing 1.280: Optimizing Keil 6/2013 (ARM mode)

```
02 0C C0 E3      BIC    R0, R0, #0x200
01 09 80 E3      ORR    R0, R0, #0x4000
1E FF 2F E1      BX     LR
```

BIC (*Bitwise bit Clear*) is an instruction for clearing specific bits. This is just like the AND instruction, but with inverted operand. I.e., it's analogous to a NOT +AND instruction pair.

ORR is "logical or", analogous to OR in x86.

So far it's easy.

## ARM + Optimizing Keil 6/2013 (Thumb mode)

Listing 1.281: Optimizing Keil 6/2013 (Thumb mode)

```
01 21 89 03      MOVS   R1, 0x4000
08 43             ORRS   R0, R1
49 11            ASRS   R1, R1, #5    ; generate 0x200 and place to R1
88 43            BICS   R0, R1
70 47            BX     LR
```

Seems like Keil decided that the code in Thumb mode, making 0x200 from 0x4000, is more compact than the code for writing 0x200 to an arbitrary register.

So that is why, with the help of ASRS (arithmetic shift right), this value is calculated as  $0x4000 \gg 5$ .

## ARM + Optimizing Xcode 4.6.3 (LLVM) (ARM mode)

Listing 1.282: Optimizing Xcode 4.6.3 (LLVM) (ARM mode)

```
42 0C C0 E3      BIC    R0, R0, #0x4200
01 09 80 E3      ORR    R0, R0, #0x4000
1E FF 2F E1      BX     LR
```

The code that was generated by LLVM, in source code form could be something like this:

```
REMOVE_BIT (rt, 0x4200);
SET_BIT (rt, 0x4000);
```

And it does exactly what we need. But why 0x4200? Perhaps that an artifact from LLVM's optimizer <sup>141</sup>.

Probably a compiler's optimizer error, but the generated code works correctly anyway.

You can read more about compiler anomalies here ( [11.4 on page 995](#)).

Optimizing Xcode 4.6.3 (LLVM) for Thumb mode generates the same code.

## ARM: more about the BIC instruction

Let's rework the example slightly:

```
int f(int a)
{
    int rt=a;

    REMOVE_BIT (rt, 0x1234);

    return rt;
};
```

<sup>141</sup>It was LLVM build 2410.2.00 bundled with Apple Xcode 4.6.3

Then the optimizing Keil 5.03 in ARM mode does:

```
f PROC
    BIC    r0,r0,#0x1000
    BIC    r0,r0,#0x234
    BX     lr
ENDP
```

There are two BIC instructions, i.e., bits 0x1234 are cleared in two passes.

This is because it's not possible to encode 0x1234 in a BIC instruction, but it's possible to encode 0x1000 and 0x234.

### ARM64: Optimizing GCC (Linaro) 4.9

Optimizing GCC compiling for ARM64 can use the AND instruction instead of BIC:

Listing 1.283: Optimizing GCC (Linaro) 4.9

```
f:
    and    w0, w0, -513    ; 0xFFFFFFFFFFFFDFF
    orr    w0, w0, 16384   ; 0x4000
    ret
```

### ARM64: Non-optimizing GCC (Linaro) 4.9

Non-optimizing GCC generates more redundant code, but works just like optimized:

Listing 1.284: Non-optimizing GCC (Linaro) 4.9

```
f:
    sub    sp, sp, #32
    str    w0, [sp,12]
    ldr    w0, [sp,12]
    str    w0, [sp,28]
    ldr    w0, [sp,28]
    orr    w0, w0, 16384   ; 0x4000
    str    w0, [sp,28]
    ldr    w0, [sp,28]
    and    w0, w0, -513    ; 0xFFFFFFFFFFFFDFF
    str    w0, [sp,28]
    ldr    w0, [sp,28]
    add    sp, sp, 32
    ret
```

## MIPS

Listing 1.285: Optimizing GCC 4.4.5 (IDA)

```
f:
; $a0=a
    ori    $a0, 0x4000
; $a0=a|0x4000
    li    $v0, 0xFFFFDFF
    jr    $ra
    and   $v0, $a0, $v0
; at finish: $v0 = $a0 & $v0 = a|0x4000 & 0xFFFFDFF
```

ORI is, of course, the OR operation. "I" in the instruction name means that the value is embedded in the machine code.

But after that we have AND. There is no way to use ANDI because it's not possible to embed the 0xFFFFDFF number in a single instruction, so the compiler has to load 0xFFFFDFF into register \$V0 first and then generates AND which takes all its values from registers.

### 1.28.3 Shifts

Bit shifts in C/C++ are implemented using `<<` and `>>` operators. The x86 ISA has the SHL (SHift Left) and SHR (SHift Right) instructions for this. Shift instructions are often used in division and multiplications by powers of two:  $2^n$  (e.g., 1, 2, 4, 8, etc.): [1.24.1 on page 213](#), [1.24.2 on page 217](#).

Shifting operations are also so important because they are often used for specific bit isolation or for constructing a value of several scattered bits.

### 1.28.4 Setting and clearing specific bits: FPU example

Here is how bits are located in the *float* type in IEEE 754 form:

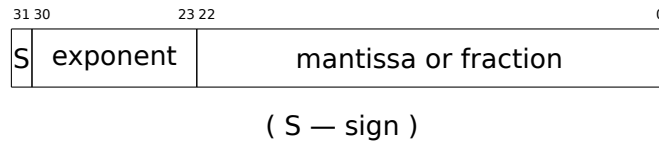

The sign of number is in the **MSB**<sup>142</sup>. Will it be possible to change the sign of a floating point number without any FPU instructions?

```
#include <stdio.h>

float my_abs (float i)
{
    unsigned int tmp=*(unsigned int*)&i & 0x7FFFFFFF;
    return *(float*)&tmp;
};

float set_sign (float i)
{
    unsigned int tmp=*(unsigned int*)&i | 0x80000000;
    return *(float*)&tmp;
};

float negate (float i)
{
    unsigned int tmp=*(unsigned int*)&i ^ 0x80000000;
    return *(float*)&tmp;
};

int main()
{
    printf ("my_abs():\n");
    printf ("%f\n", my_abs (123.456));
    printf ("%f\n", my_abs (-456.123));
    printf ("set_sign():\n");
    printf ("%f\n", set_sign (123.456));
    printf ("%f\n", set_sign (-456.123));
    printf ("negate():\n");
    printf ("%f\n", negate (123.456));
    printf ("%f\n", negate (-456.123));
};
```

We need this trickery in C/C++ to copy to/from *float* value without actual conversion. So there are three functions: `my_abs()` resets **MSB**; `set_sign()` sets **MSB** and `negate()` flips it.

XOR can be used to flip a bit: [2.6 on page 461](#).

### x86

The code is pretty straightforward:

Listing 1.286: Optimizing MSVC 2012

```
_tmp$ = 8
_i$ = 8
_my_abs PROC
```

<sup>142</sup>Most Significant Bit



```

        and    DWORD PTR _i$[esp-4], 2147483647 ; 7fffffffH
        fld    DWORD PTR _tmp$[esp-4]
        ret    0
_my_abs ENDP

_tmp$ = 8
_i$ = 8
_set_sign PROC
        or     DWORD PTR _i$[esp-4], -2147483648 ; 80000000H
        fld    DWORD PTR _tmp$[esp-4]
        ret    0
_set_sign ENDP

_tmp$ = 8
_i$ = 8
_negate PROC
        xor    DWORD PTR _i$[esp-4], -2147483648 ; 80000000H
        fld    DWORD PTR _tmp$[esp-4]
        ret    0
_negate ENDP

```

An input value of type *float* is taken from the stack, but treated as an integer value.

AND and OR reset and set the desired bit. XOR flips it.

Finally, the modified value is loaded into ST0, because floating-point numbers are returned in this register.

Now let's try optimizing MSVC 2012 for x64:

Listing 1.287: Optimizing MSVC 2012 x64

```

tmp$ = 8
i$ = 8
my_abs PROC
        movss  DWORD PTR [rsp+8], xmm0
        mov    eax, DWORD PTR i$[rsp]
        btr   eax, 31
        mov   DWORD PTR tmp$[rsp], eax
        movss xmm0, DWORD PTR tmp$[rsp]
        ret   0
my_abs ENDP
_TEXT ENDS

tmp$ = 8
i$ = 8
set_sign PROC
        movss  DWORD PTR [rsp+8], xmm0
        mov    eax, DWORD PTR i$[rsp]
        bts   eax, 31
        mov   DWORD PTR tmp$[rsp], eax
        movss xmm0, DWORD PTR tmp$[rsp]
        ret   0
set_sign ENDP

tmp$ = 8
i$ = 8
negate PROC
        movss  DWORD PTR [rsp+8], xmm0
        mov    eax, DWORD PTR i$[rsp]
        btc   eax, 31
        mov   DWORD PTR tmp$[rsp], eax
        movss xmm0, DWORD PTR tmp$[rsp]
        ret   0
negate ENDP

```

The input value is passed in XMM0, then it is copied into the local stack and then we see some instructions that are new to us: BTR, BTS, BTC.

These instructions are used for resetting (BTR), setting (BTS) and inverting (or complementing: BTC) specific bits. The 31st bit is **MSB**, counting from 0.

Finally, the result is copied into XMM0, because floating point values are returned through XMM0 in Win64 environment.

## MIPS

GCC 4.4.5 for MIPS does mostly the same:

Listing 1.288: Optimizing GCC 4.4.5 (IDA)

```
my_abs:
; move from coprocessor 1:
    mfc1    $v1, $f12
    li      $v0, 0x7FFFFFFF
; $v0=0x7FFFFFFF
; do AND:
    and     $v0, $v1
; move to coprocessor 1:
    mtc1    $v0, $f0
; return
    jr      $ra
    or      $at, $zero ; branch delay slot

set_sign:
; move from coprocessor 1:
    mfc1    $v0, $f12
    lui     $v1, 0x8000
; $v1=0x80000000
; do OR:
    or      $v0, $v1, $v0
; move to coprocessor 1:
    mtc1    $v0, $f0
; return
    jr      $ra
    or      $at, $zero ; branch delay slot

negate:
; move from coprocessor 1:
    mfc1    $v0, $f12
    lui     $v1, 0x8000
; $v1=0x80000000
; do XOR:
    xor     $v0, $v1, $v0
; move to coprocessor 1:
    mtc1    $v0, $f0
; return
    jr      $ra
    or      $at, $zero ; branch delay slot
```

One single LUI instruction is used to load 0x80000000 into a register, because LUI is clearing the low 16 bits and these are zeros in the constant, so one LUI without subsequent ORI is enough.

## ARM

### Optimizing Keil 6/2013 (ARM mode)

Listing 1.289: Optimizing Keil 6/2013 (ARM mode)

```
my_abs PROC
; clear bit:
    BIC     r0, r0, #0x80000000
    BX     lr
    ENDP

set_sign PROC
; do OR:
    ORR     r0, r0, #0x80000000
    BX     lr
    ENDP
```

```

negate PROC
; do XOR:
    EOR    r0,r0,#0x80000000
    BX     lr
ENDP

```

So far so good.

ARM has the BIC instruction, which explicitly clears specific bit(s). EOR is the ARM instruction name for XOR (“Exclusive OR”).

### Optimizing Keil 6/2013 (Thumb mode)

Listing 1.290: Optimizing Keil 6/2013 (Thumb mode)

```

my_abs PROC
    LSLS    r0,r0,#1
; r0=i<<1
    LSRS    r0,r0,#1
; r0=(i<<1)>>1
    BX     lr
ENDP

set_sign PROC
    MOVS    r1,#1
; r1=1
    LSLS    r1,r1,#31
; r1=1<<31=0x80000000
    ORRS    r0,r0,r1
; r0=r0 | 0x80000000
    BX     lr
ENDP

negate PROC
    MOVS    r1,#1
; r1=1
    LSLS    r1,r1,#31
; r1=1<<31=0x80000000
    EORS    r0,r0,r1
; r0=r0 ^ 0x80000000
    BX     lr
ENDP

```

Thumb mode in ARM offers 16-bit instructions and not much data can be encoded in them, so here a MOVS/LSLS instruction pair is used for forming the 0x80000000 constant. It works like this:  $1 \ll 31 = 0x80000000$ .

The code of `my_abs` is weird and it effectively works like this expression:  $(i \ll 1) \gg 1$ . This statement looks meaningless. But nevertheless, when `input << 1` is executed, the **MSB** (sign bit) is just dropped. When the subsequent `result >> 1` statement is executed, all bits are now in their own places, but **MSB** is zero, because all “new” bits appearing from the shift operations are always zeros. That is how the LSLS/LSRS instruction pair clears **MSB**.

### Optimizing GCC 4.6.3 (Raspberry Pi, ARM mode)

Listing 1.291: Optimizing GCC 4.6.3 for Raspberry Pi (ARM mode)

```

my_abs
; copy from S0 to R2:
    FMRS    R2, S0
; clear bit:
    BIC     R3, R2, #0x80000000
; copy from R3 to S0:
    FMSR    S0, R3
    BX     LR

set_sign

```

```

; copy from S0 to R2:
    FMRS    R2, S0
; do OR:
    ORR     R3, R2, #0x80000000
; copy from R3 to S0:
    FMSR    S0, R3
    BX      LR

negate
; copy from S0 to R2:
    FMRS    R2, S0
; do ADD:
    ADD     R3, R2, #0x80000000
; copy from R3 to S0:
    FMSR    S0, R3
    BX      LR

```

Let's run Raspberry Pi Linux in QEMU and it emulates an ARM FPU, so S-registers are used here for floating point numbers instead of R-registers.

The FMRS instruction copies data from [GPR](#) to the FPU and back.

`my_abs()` and `set_sign()` looks as expected, but `negate()`? Why is there ADD instead of XOR?

It's hard to believe, but the instruction `ADD register, 0x80000000` works just like `XOR register, 0x80000000`. First of all, what's our goal? The goal is to flip the [MSB](#), so let's forget about the XOR operation. From school-level mathematics we may recall that adding values like 1000 to other values never affects the last 3 digits. For example:  $1234567 + 10000 = 1244567$  (last 4 digits are never affected).

But here we operate in binary base and `0x80000000` is `0b10000000000000000000000000000000`, i.e., only the highest bit is set.

Adding `0x80000000` to any value never affects the lowest 31 bits, but affects only the [MSB](#). Adding 1 to 0 is resulting in 1.

Adding 1 to 1 is resulting in `0b10` in binary form, but the 32th bit (counting from zero) gets dropped, because our registers are 32 bit wide, so the result is 0. That's why XOR can be replaced by ADD here.

It's hard to say why GCC decided to do this, but it works correctly.

## 1.28.5 Counting bits set to 1

Here is a simple example of a function that calculates the number of bits set in the input value.

This operation is also called "population count"<sup>143</sup>.

```

#include <stdio.h>

#define IS_SET(flag, bit)    ((flag) & (bit))

int f(unsigned int a)
{
    int i;
    int rt=0;

    for (i=0; i<32; i++)
        if (IS_SET (a, 1<<i))
            rt++;

    return rt;
};

int main()
{
    f(0x12345678); // test
};

```

<sup>143</sup>modern x86 CPUs (supporting SSE4) even have a POPCNT instruction for it

In this loop, the iteration count value  $i$  is counting from 0 to 31, so the  $1 \ll i$  statement is counting from 1 to  $0x80000000$ . Describing this operation in natural language, we would say *shift 1 by  $n$  bits left*. In other words,  $1 \ll i$  statement consequently produces all possible bit positions in a 32-bit number. The freed bit at right is always cleared.

Here is a table of all possible  $1 \ll i$  for  $i = 0 \dots 31$ :

C/C++ expression	Power of two	Decimal form	Hexadecimal form
$1 \ll 0$	$2^0$	1	1
$1 \ll 1$	$2^1$	2	2
$1 \ll 2$	$2^2$	4	4
$1 \ll 3$	$2^3$	8	8
$1 \ll 4$	$2^4$	16	0x10
$1 \ll 5$	$2^5$	32	0x20
$1 \ll 6$	$2^6$	64	0x40
$1 \ll 7$	$2^7$	128	0x80
$1 \ll 8$	$2^8$	256	0x100
$1 \ll 9$	$2^9$	512	0x200
$1 \ll 10$	$2^{10}$	1024	0x400
$1 \ll 11$	$2^{11}$	2048	0x800
$1 \ll 12$	$2^{12}$	4096	0x1000
$1 \ll 13$	$2^{13}$	8192	0x2000
$1 \ll 14$	$2^{14}$	16384	0x4000
$1 \ll 15$	$2^{15}$	32768	0x8000
$1 \ll 16$	$2^{16}$	65536	0x10000
$1 \ll 17$	$2^{17}$	131072	0x20000
$1 \ll 18$	$2^{18}$	262144	0x40000
$1 \ll 19$	$2^{19}$	524288	0x80000
$1 \ll 20$	$2^{20}$	1048576	0x100000
$1 \ll 21$	$2^{21}$	2097152	0x200000
$1 \ll 22$	$2^{22}$	4194304	0x400000
$1 \ll 23$	$2^{23}$	8388608	0x800000
$1 \ll 24$	$2^{24}$	16777216	0x1000000
$1 \ll 25$	$2^{25}$	33554432	0x2000000
$1 \ll 26$	$2^{26}$	67108864	0x4000000
$1 \ll 27$	$2^{27}$	134217728	0x8000000
$1 \ll 28$	$2^{28}$	268435456	0x10000000
$1 \ll 29$	$2^{29}$	536870912	0x20000000
$1 \ll 30$	$2^{30}$	1073741824	0x40000000
$1 \ll 31$	$2^{31}$	2147483648	0x80000000

These constant numbers (bit masks) very often appear in code and a practicing reverse engineer must be able to spot them quickly.

Decimal numbers below 65536 and hexadecimal ones are very easy to memorize. While decimal numbers above 65536 are, probably, not worth memorizing.

These constants are very often used for mapping flags to specific bits. For example, here is excerpt from `ssl_private.h` from Apache 2.4.6 source code:

```
/**
 * Define the SSL options
 */
#define SSL_OPT_NONE          (0)
#define SSL_OPT_RELSET        (1<<0)
#define SSL_OPT_STDENVVARS    (1<<1)
#define SSL_OPT_EXPORTCERTDATA (1<<3)
#define SSL_OPT_FAKEBASICAUTH (1<<4)
#define SSL_OPT_STRICTREQUIRE (1<<5)
#define SSL_OPT_OPTRENEGOTIATE (1<<6)
#define SSL_OPT_LEGACYDNFORMAT (1<<7)
```

Let's get back to our example.

The `IS_SET` macro checks bit presence in  $a$ .

The IS\_SET macro is in fact the logical AND operation (*AND*) and it returns 0 if the specific bit is absent there, or the bit mask, if the bit is present. *The if()* operator in C/C++ triggers if the expression in it is not zero, it might be even 123456, that is why it always works correctly.

## x86

### MSVC

Let's compile (MSVC 2010):

Listing 1.292: MSVC 2010

```
_rt$ = -8          ; size = 4
_i$ = -4          ; size = 4
_a$ = 8           ; size = 4
_f PROC
    push    ebp
    mov     ebp, esp
    sub     esp, 8
    mov     DWORD PTR _rt$[ebp], 0
    mov     DWORD PTR _i$[ebp], 0
    jmp     SHORT $LN4@f
$LN3@f:
    mov     eax, DWORD PTR _i$[ebp] ; increment of i
    add     eax, 1
    mov     DWORD PTR _i$[ebp], eax
$LN4@f:
    cmp     DWORD PTR _i$[ebp], 32 ; 00000020H
    jge     SHORT $LN2@f          ; loop finished?
    mov     edx, 1
    mov     ecx, DWORD PTR _i$[ebp]
    shl     edx, cl                ; EDX=EDX<<CL
    and     edx, DWORD PTR _a$[ebp]
    je      SHORT $LN1@f          ; result of AND instruction was 0?
                                        ; then skip next instructions
    mov     eax, DWORD PTR _rt$[ebp] ; no, not zero
    add     eax, 1                 ; increment rt
    mov     DWORD PTR _rt$[ebp], eax
$LN1@f:
    jmp     SHORT $LN3@f
$LN2@f:
    mov     eax, DWORD PTR _rt$[ebp]
    mov     esp, ebp
    pop     ebp
    ret     0
_f      ENDP
```

## OllyDbg

Let's load this example into OllyDbg. Let the input value be 0x12345678.

For  $i = 1$ , we see how  $i$  is loaded into ECX:

The screenshot shows the OllyDbg interface with the following details:

- Assembly Window:** Displays assembly instructions from address 00291001 to 00291034. The instruction at 00291020 is highlighted: `SHL EDX, CL`. Below the assembly window, it shows `CL=01` and `EDX=1`.
- Registers (FPU) Window:** Shows the state of registers. `ECX` is highlighted with the value `00000001`. Other registers like `EAX`, `EDX`, `EBX`, etc., are shown with their respective values.
- Hex Dump Window:** Shows memory addresses from 00293000 to 00293080. The hex dump is mostly zeros, with some non-zero values at 00293010 and 00293070.

Figure 1.99: OllyDbg:  $i = 1$ ,  $i$  is loaded into ECX

EDX is 1. SHL is to be executed now.

SHL has been executed:

The screenshot shows the OllyDbg interface with the following details:

- Assembly List:**
  - 00291003: 83EC 08 SUB ESP,8
  - 00291006: C745 F8 0000 MOV DWORD PTR SS:[LOCAL.2],0
  - 0029100D: C745 FC 0000 MOV DWORD PTR SS:[LOCAL.1],0
  - 00291014: EB 09 JMP SHORT 0029101F
  - 00291016: 8B45 FC MOV EAX,DWORD PTR SS:[LOCAL.1]
  - 00291019: 83C0 01 ADD EAX,1
  - 0029101C: 8945 FC MOV DWORD PTR SS:[LOCAL.1],EAX
  - 0029101F: 837D FC 20 CMP DWORD PTR SS:[LOCAL.1],20
  - 00291023: 7D 1A JGE SHORT 0029103F
  - 00291025: BA 01000000 MOV EDX,1
  - 0029102A: 8B45 FC MOV ECX,DWORD PTR SS:[LOCAL.1]
  - 0029102D: D3E2 SHL EDX,CL
  - 0029102F: 2355 08 AND EDX,DWORD PTR SS:[ARG.1] (highlighted)
  - 00291032: 74 09 JZ SHORT 0029103D
  - 00291034: 8B45 F8 MOV EAX,DWORD PTR SS:[LOCAL.2]
  - 00291037: 83C0 01 ADD EAX,1
- Registers (FPU):**
  - EAX: 00000001
  - ECX: 00000001
  - EDX: 00000002** (highlighted)
  - EBX: 00000000
  - ESP: 0014F974
  - EBP: 0014F97C
  - ESI: 00000001
  - EDI: 00293378 shifts.00293378
  - EIP: 0029102F shifts.0029102F
- Stack [0014F984]=12345678:**
  - EDX=00000002
  - Loop 00291016: loop variable [LOCAL.1](+1)
- Hex dump:**

Address	Hex dump	ASCII (ANSI)
00293000	FF FF FF FF FF FF FF FF 00 00 00 00 00 00 00 00	
00293010	FE FF FF FF 01 00 00 FF F8 07 9A F9 07 F8 65 06	0 °.b
00293020	01 00 00 00 48 28 51 00 68 4E 51 00 00 00 00 00	0 H(Q hNQ
00293030	00 00 00 00 00 00 00 00 00 00 00 00 00 00 00 00	
00293040	00 00 00 00 00 00 00 00 00 00 00 00 00 00 00 00	
00293050	00 00 00 00 00 00 00 00 00 00 00 00 00 00 00 00	
00293060	00 00 00 00 00 00 00 00 00 00 00 00 00 00 00 00	
00293070	00 00 00 00 00 00 00 00 00 00 00 00 00 00 00 00	
00293080	00 00 00 00 00 00 00 00 00 00 00 00 00 00 00 00	
- Return Addresses:**
  - 0014F974: 00000000
  - 0014F978: 00000001
  - 0014F97C: 0014F988
  - 0014F980: 0029105D
  - 0014F984: 12345678
  - 0014F988: 0014F9CC
  - 0014F98C: 002911D1
  - 0014F990: 00000001
  - 0014F994: 00514E68
  - 0014F998: 00512848
  - 0014F99C: 00512848

Figure 1.100: OllyDbg:  $i = 1$ ,  $EDX = 1 \ll 1 = 2$

EDX contain  $1 \ll 1$  (or 2). This is a bit mask.



AND sets ZF to 1, which implies that the input value (0x12345678) ANDed with 2 results in 0:

The screenshot shows the CPU window in OllyDbg. The assembly list on the left includes instructions from 00291006 to 00291037. The instruction at 00291032 is `JZ SHORT 0029103D`, which is highlighted in grey. A red box around the instruction has the text "Jump is taken" written below it. The registers window on the right shows the ZF flag set to 1. The status bar at the bottom indicates the current instruction is `JZ SHORT 0029103D`.

Figure 1.101: OllyDbg:  $i = 1$ , is there that bit in the input value? No. (ZF = 1)

So, there is no corresponding bit in the input value.

The piece of code, which **increments** the counter is not to be executed: the JZ instruction *bypassing* it.

Let's trace a bit further and *i* is now 4. SHL is to be executed now:

**CPU - main thread, module shifts**

Address	Hex dump	ASCII (ANSI)
00293000	FF FF FF FF FF FF FF FF 00 00 00 00 00 00 00 00	
00293010	FE FF FF FF 01 00 00 00 F8 07 9A F9 07 F8 65 06	°·b
00293020	01 00 00 00 48 28 51 00 68 4E 51 00 00 00 00 00	H(Q hNQ
00293030	00 00 00 00 00 00 00 00 00 00 00 00 00 00 00 00	
00293040	00 00 00 00 00 00 00 00 00 00 00 00 00 00 00 00	
00293050	00 00 00 00 00 00 00 00 00 00 00 00 00 00 00 00	
00293060	00 00 00 00 00 00 00 00 00 00 00 00 00 00 00 00	
00293070	00 00 00 00 00 00 00 00 00 00 00 00 00 00 00 00	
00293080	00 00 00 00 00 00 00 00 00 00 00 00 00 00 00 00	

Register	Value
EAX	00000004
ECX	00000004
EDX	00000001
EBX	00000000
ESP	0014F974
EBP	0014F97C
ESI	00000001
EDI	00293378 shifts.00293378
EIP	0029102D shifts.0029102D

CL=04  
EDX=1  
Loop 00291016: loop variable [LOCAL.1](+1)

Figure 1.102: OllyDbg: *i* = 4, *i* is loaded into ECX

EDX =  $1 \ll 4$  (or  $0x10$  or  $16$ ):

**CPU - main thread, module shifts**

00291003	83EC 08	SUB ESP, 8
00291006	C745 F8 0000	MOV DWORD PTR SS:[LOCAL.2], 0
0029100D	C745 FC 0000	MOV DWORD PTR SS:[LOCAL.1], 0
00291014	EB 09	JMP SHORT 0029101F
00291016	8B45 FC	MOV EAX, DWORD PTR SS:[LOCAL.1]
00291019	83C0 01	ADD EAX, 1
0029101C	8945 FC	MOV DWORD PTR SS:[LOCAL.1], EAX
0029101F	837D FC 20	CMP DWORD PTR SS:[LOCAL.1], 20
00291023	7D 1A	JGE SHORT 0029103F
00291025	BA 01000000	MOV EDX, 1
0029102A	8B4D FC	MOV ECX, DWORD PTR SS:[LOCAL.1]
0029102D	D3E2	SHL EDX, CL
0029102F	2355 08	AND EDX, DWORD PTR SS:[ARG.1]
00291032	74 09	JZ SHORT 0029103D
00291034	8B45 F8	MOV EAX, DWORD PTR SS:[LOCAL.2]
00291037	83C0 01	ADD EAX, 1

Stack [0014F984]=12345678  
EDX=00000010  
Loop 00291016: loop variable [LOCAL.1](+1)

**Registers (FPU)**

EAX 00000004  
ECX 00000004  
**EDX 00000010**  
EBX 00000000  
ESP 0014F974  
EBP 0014F97C  
ESI 00000001  
EDI 00293378 shifts.00293378  
EIP 0029102F shifts.0029102F

C 0 ES 002B 32bit 0(FFFFFFFF)  
P 0 CS 0023 32bit 0(FFFFFFFF)  
A 0 SS 002B 32bit 0(FFFFFFFF)  
Z 0 DS 002B 32bit 0(FFFFFFFF)  
S 0 FS 0053 32bit 7EFD0000(FFF)  
T 0 GS 002B 32bit 0(FFFFFFFF)  
D 0  
I 0  
O 0 LastErr 00000000 ERROR\_SUCCESS  
EFL 00000202 (NO, NB, NE, A, NS, PO, GE, G)

Address	Hex dump	ASCII (ANSI)
00293000	FF FF FF FF FF FF FF FF 00 00 00 00 00 00 00 00	
00293010	FE FF FF FF 01 00 00 00 F8 07 9A F9 07 F8 65 06	0 °.b-
00293020	01 00 00 00 48 28 51 00 68 4E 51 00 00 00 00 00	0 H(Q hNQ
00293030	00 00 00 00 00 00 00 00 00 00 00 00 00 00 00 00	
00293040	00 00 00 00 00 00 00 00 00 00 00 00 00 00 00 00	
00293050	00 00 00 00 00 00 00 00 00 00 00 00 00 00 00 00	
00293060	00 00 00 00 00 00 00 00 00 00 00 00 00 00 00 00	
00293070	00 00 00 00 00 00 00 00 00 00 00 00 00 00 00 00	
00293080	00 00 00 00 00 00 00 00 00 00 00 00 00 00 00 00	

0014F974 00000001 0  
0014F978 00000004  
0014F97C 0014F988 |<¶  
0014F980 0029105D |>|  
0014F984 12345678 H(U4¶  
0014F988 0014F9CC |F·¶  
0014F98C 002911D1 |¶|  
0014F990 00000001 0  
0014F994 00514E68 hNQ  
0014F998 00512848 H(Q  
0014F99C 00000004

RETURN from shi  
RETURN from shi  
ASCII "pNQ"

Figure 1.103: OllyDbg:  $i = 4$ ,  $EDX = 1 \ll 4 = 0x10$

This is another bit mask.

AND is executed:

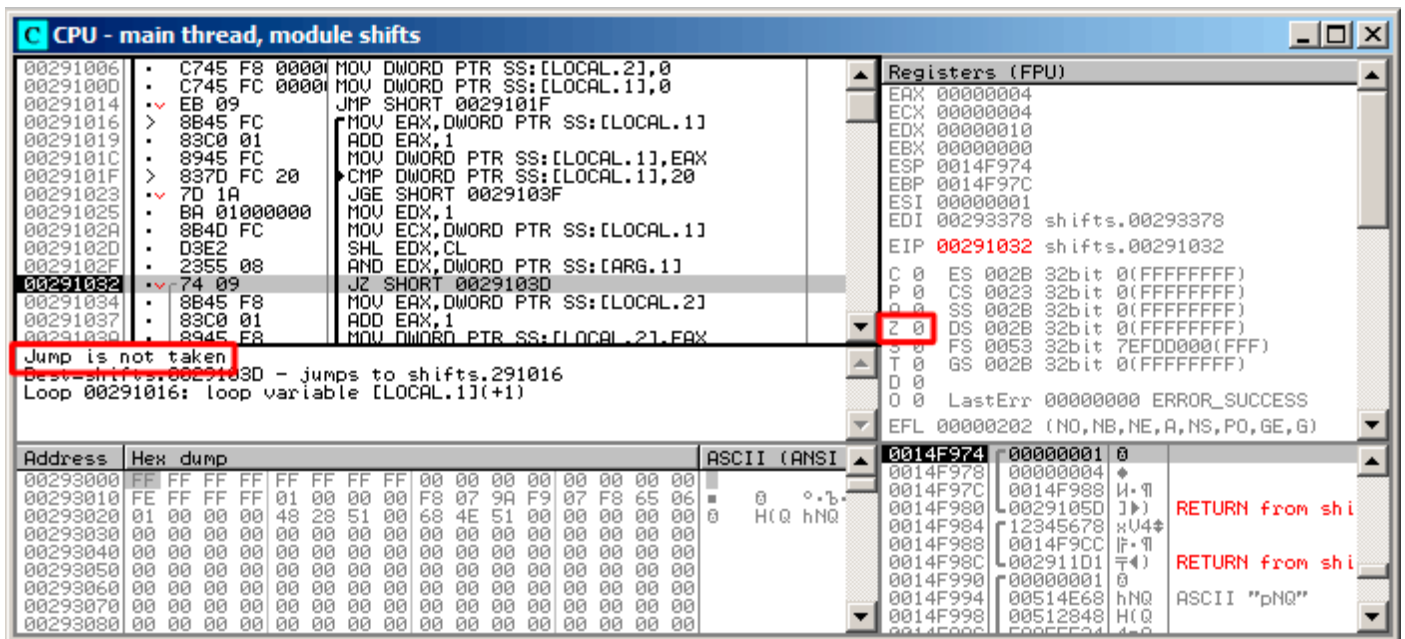

Figure 1.104: OllyDbg:  $i = 4$ , is there that bit in the input value? Yes. (ZF = 0)

ZF is 0 because this bit is present in the input value. Indeed,  $0x12345678 \& 0x10 = 0x10$ .

This bit counts: the jump is not triggering and the bit counter [incrementing](#).

The function returns 13. This is total number of bits set in  $0x12345678$ .

## GCC

Let's compile it in GCC 4.4.1:

Listing 1.293: GCC 4.4.1

```

f
public f
proc near

rt
    = dword ptr -0Ch
i
    = dword ptr -8
arg_0
    = dword ptr 8

    push    ebp
    mov     ebp, esp
    push    ebx
    sub     esp, 10h
    mov     [ebp+rt], 0
    mov     [ebp+i], 0
    jmp     short loc_80483EF

loc_80483D0:
    mov     eax, [ebp+i]
    mov     edx, 1
    mov     ebx, edx
    mov     ecx, eax
    shl     ebx, cl
    mov     eax, ebx
    and     eax, [ebp+arg_0]
    test    eax, eax
    jz     short loc_80483EB
    add     [ebp+rt], 1

loc_80483EB:
    add     [ebp+i], 1

loc_80483EF:

```

```

        cmp     [ebp+i], 1Fh
        jle     short loc_80483D0
        mov     eax, [ebp+rt]
        add     esp, 10h
        pop     ebx
        pop     ebp
        retn
f:
        endp

```

## x64

Let's modify the example slightly to extend it to 64-bit:

```

#include <stdio.h>
#include <stdint.h>

#define IS_SET(flag, bit)      ((flag) & (bit))

int f(uint64_t a)
{
    uint64_t i;
    int rt=0;

    for (i=0; i<64; i++)
        if (IS_SET (a, 1ULL<<i))
            rt++;

    return rt;
};

```

## Non-optimizing GCC 4.8.2

So far so easy.

Listing 1.294: Non-optimizing GCC 4.8.2

```

f:
    push    rbp
    mov     rbp, rsp
    mov     QWORD PTR [rbp-24], rdi ; a
    mov     DWORD PTR [rbp-12], 0 ; rt=0
    mov     QWORD PTR [rbp-8], 0 ; i=0
    jmp     .L2

.L4:
    mov     rax, QWORD PTR [rbp-8]
    mov     rdx, QWORD PTR [rbp-24]
; RAX = i, RDX = a
    mov     ecx, eax
; ECX = i
    shr     rdx, cl
; RDX = RDX>>CL = a>>i
    mov     rax, rdx
; RAX = RDX = a>>i
    and     eax, 1
; EAX = EAX&1 = (a>>i)&1
    test    rax, rax
; the last bit is zero?
; skip the next ADD instruction, if it was so.
    je     .L3
    add     DWORD PTR [rbp-12], 1 ; rt++

.L3:
    add     QWORD PTR [rbp-8], 1 ; i++

.L2:
    cmp     QWORD PTR [rbp-8], 63 ; i<63?
    jbe    .L4 ; jump to the loop body begin, if so
    mov     eax, DWORD PTR [rbp-12] ; return rt
    pop     rbp
    ret

```

## Optimizing GCC 4.8.2

Listing 1.295: Optimizing GCC 4.8.2

```
1 f:
2     xor     eax, eax      ; rt variable will be in EAX register
3     xor     ecx, ecx      ; i variable will be in ECX register
4 .L3:
5     mov     rsi, rdi      ; load input value
6     lea    edx, [rax+1]   ; EDX=EAX+1
7     ; EDX here is a new version of rt,
8     ; which will be written into rt variable, if the last bit is 1
9     shr     rsi, cl       ; RSI=RSI>>CL
10    and     esi, 1        ; ESI=ESI&1
11    ; the last bit is 1? If so, write new version of rt into EAX
12    cmovne  eax, edx
13    add     rcx, 1        ; RCX++
14    cmp     rcx, 64
15    jne     .L3
16    rep ret              ; AKA fatret
```

This code is terser, but has a quirk.

In all examples that we see so far, we were incrementing the “rt” value after comparing a specific bit, but the code here increments “rt” before (line 6), writing the new value into register EDX. Thus, if the last bit is 1, the CMOVNE<sup>144</sup> instruction (which is a synonym for CMOVNZ<sup>145</sup>) *commits* the new value of “rt” by moving EDX (“proposed rt value”) into EAX (“current rt” to be returned at the end).

Hence, the incrementing is performed at each step of loop, i.e., 64 times, without any relation to the input value.

The advantage of this code is that it contain only one conditional jump (at the end of the loop) instead of two jumps (skipping the “rt” value increment and at the end of loop). And that might work faster on the modern CPUs with branch predictors: [2.10.1 on page 466](#).

The last instruction is REP RET (opcode F3 C3) which is also called FATRET by MSVC. This is somewhat optimized version of RET, which is recommended by AMD to be placed at the end of function, if RET goes right after conditional jump: [*Software Optimization Guide for AMD Family 16h Processors*, (2013)p.15]<sup>146</sup>.

## Optimizing MSVC 2010

Listing 1.296: Optimizing MSVC 2010

```
a$ = 8
f PROC
; RCX = input value
    xor     eax, eax
    mov     edx, 1
    lea    r8d, QWORD PTR [rax+64]
; R8D=64
    npad   5
$LL4@f:
    test   rdx, rcx
; there are no such bit in input value?
; skip the next INC instruction then.
    je     SHORT $LN3@f
    inc    eax      ; rt++
$LN3@f:
    rol   rdx, 1   ; RDX=RDX<<1
    dec   r8       ; R8--
    jne   SHORT $LL4@f
    fatret 0
f ENDP
```

<sup>144</sup>Conditional MOVE if Not Equal

<sup>145</sup>Conditional MOVE if Not Zero

<sup>146</sup>More information on it: <http://go.yurichev.com/17328>

Here the ROL instruction is used instead of SHL, which is in fact “rotate left” instead of “shift left”, but in this example it works just as SHL.

You can read more about the rotate instruction here: [.1.6 on page 1035](#).

R8 here is counting from 64 to 0. It’s just like an inverted *i*.

Here is a table of some registers during the execution:

RDX	R8
0x0000000000000001	64
0x0000000000000002	63
0x0000000000000004	62
0x0000000000000008	61
...	...
0x4000000000000000	2
0x8000000000000000	1

At the end we see the FATRET instruction, which was explained here: [1.28.5 on the previous page](#).

## Optimizing MSVC 2012

Listing 1.297: Optimizing MSVC 2012

```

a$ = 8
f PROC
; RCX = input value
xor    eax, eax
mov    edx, 1
lea    r8d, QWORD PTR [rax+32]
; EDX = 1, R8D = 32
npad   5
$LL4@f:
; pass 1 -----
test   rdx, rcx
je     SHORT $LN3@f
inc    eax    ; rt++
$LN3@f:
rol    rdx, 1 ; RDX=RDX<<1
; -----
; pass 2 -----
test   rdx, rcx
je     SHORT $LN11@f
inc    eax    ; rt++
$LN11@f:
rol    rdx, 1 ; RDX=RDX<<1
; -----
dec    r8     ; R8--
jne    SHORT $LL4@f
fatret 0
f     ENDP

```

Optimizing MSVC 2012 does almost the same job as optimizing MSVC 2010, but somehow, it generates two identical loop bodies and the loop count is now 32 instead of 64.

To be honest, it’s not possible to say why. Some optimization trick? Maybe it’s better for the loop body to be slightly longer?

Anyway, such code is relevant here to show that sometimes the compiler output may be really weird and illogical, but perfectly working.

## ARM + Optimizing Xcode 4.6.3 (LLVM) (ARM mode)

Listing 1.298: Optimizing Xcode 4.6.3 (LLVM) (ARM mode)

```

MOV    R1, R0
MOV    R0, #0
MOV    R2, #1
MOV    R3, R0
loc_2E54

```

```

TST      R1, R2, LSL R3 ; set flags according to R1 & (R2<<R3)
ADD      R3, R3, #1    ; R3++
ADDNE    R0, R0, #1    ; if ZF flag is cleared by TST, then R0++
CMP      R3, #32
BNE      loc_2E54
BX
LR

```

TST is the same thing as TEST in x86.

As was noted before ( [3.12.3 on page 503](#)), there are no separate shifting instructions in ARM mode. However, there are modifiers LSL (*Logical Shift Left*), LSR (*Logical Shift Right*), ASR (*Arithmetic Shift Right*), ROR (*Rotate Right*) and RRX (*Rotate Right with Extend*), which may be added to such instructions as MOV, TST, CMP, ADD, SUB, RSB<sup>147</sup>.

These modifiers define how to shift the second operand and by how many bits.

Thus the “TST R1, R2, LSL R3” instruction works here as  $R1 \wedge (R2 \ll R3)$ .

### ARM + Optimizing Xcode 4.6.3 (LLVM) (Thumb-2 mode)

Almost the same, but here are two LSL.W/TST instructions are used instead of a single TST, because in Thumb mode it is not possible to define LSL modifier directly in TST.

```

loc_2F7A
MOV      R1, R0
MOVS     R0, #0
MOV.W   R9, #1
MOVS     R3, #0
LSL.W   R2, R9, R3
TST      R2, R1
ADD.W   R3, R3, #1
IT NE
ADDNE    R0, #1
CMP      R3, #32
BNE      loc_2F7A
BX
LR

```

### ARM64 + Optimizing GCC 4.9

Let’s take the 64-bit example which has been already used: [1.28.5 on page 331](#).

Listing 1.299: Optimizing GCC (Linaro) 4.8

```

f:
    mov     w2, 0           ; rt=0
    mov     x5, 1
    mov     w1, w2
.L2:
    lsl     x4, x5, x1     ; w4 = w5<<w1 = 1<<i
    add     w3, w2, 1     ; new_rt=rt+1
    tst     x4, x0        ; (1<<i) & a
    add     w1, w1, 1     ; i++
; result of TST was non-zero?
; then w2=w3 or rt=new_rt.
; otherwise: w2=w2 or rt=rt (idle operation)
    csel    w2, w3, w2, ne
    cmp     w1, 64        ; i<64?
    bne    .L2           ; yes
    mov     w0, w2       ; return rt
    ret

```

The result is very similar to what GCC generates for x64: [1.295 on page 332](#).

The CSEL instruction is “Conditional SElect”. It just chooses one variable of two depending on the flags set by TST and copies the value into W2, which holds the “rt” variable.

<sup>147</sup>These instructions are also called “data processing instructions”



## ARM64 + Non-optimizing GCC 4.9

And again, we'll work on the 64-bit example which was already used: [1.28.5 on page 331](#). The code is more verbose, as usual.

Listing 1.300: Non-optimizing GCC (Linaro) 4.8

```
f:
    sub    sp, sp, #32
    str    x0, [sp,8]      ; store "a" value to Register Save Area
    str    wzr, [sp,24]    ; rt=0
    str    wzr, [sp,28]    ; i=0
    b     .L2
.L4:
    ldr    w0, [sp,28]
    mov    x1, 1
    lsl    x0, x1, x0      ; X0 = X1<<X0 = 1<<i
    mov    x1, x0
; X1 = 1<<i
    ldr    x0, [sp,8]
; X0 = a
    and    x0, x1, x0
; X0 = X1&X0 = (1<<i) & a
; X0 contain zero? then jump to .L3, skipping "rt" increment
    cmp    x0, xzr
    beq    .L3
; rt++
    ldr    w0, [sp,24]
    add    w0, w0, 1
    str    w0, [sp,24]
.L3:
; i++
    ldr    w0, [sp,28]
    add    w0, w0, 1
    str    w0, [sp,28]
.L2:
; i<=63? then jump to .L4
    ldr    w0, [sp,28]
    cmp    w0, 63
    ble    .L4
; return rt
    ldr    w0, [sp,24]
    add    sp, sp, 32
    ret
```

## MIPS

### Non-optimizing GCC

Listing 1.301: Non-optimizing GCC 4.4.5 (IDA)

```
f:
; IDA is not aware of variable names, we gave them manually:
rt      = -0x10
i       = -0xC
var_4   = -4
a       = 0

    addiu $sp, -0x18
    sw    $fp, 0x18+var_4($sp)
    move  $fp, $sp
    sw    $a0, 0x18+a($fp)
; initialize rt and i variables to zero:
    sw    $zero, 0x18+rt($fp)
    sw    $zero, 0x18+i($fp)
; jump to loop check instructions:
    b     loc_68
    or    $at, $zero ; branch delay slot, NOP
```

```

loc_20:
    li    $v1, 1
    lw    $v0, 0x18+i($fp)
    or    $at, $zero ; load delay slot, NOP
    sllv  $v0, $v1, $v0
; $v0 = 1<<i
    move  $v1, $v0
    lw    $v0, 0x18+a($fp)
    or    $at, $zero ; load delay slot, NOP
    and   $v0, $v1, $v0
; $v0 = a & (1<<i)
; is a & (1<<i) equals to zero? jump to loc_58 then:
    beqz  $v0, loc_58
    or    $at, $zero
; no jump occurred, that means a & (1<<i)!=0, so increment "rt" then:
    lw    $v0, 0x18+rt($fp)
    or    $at, $zero ; load delay slot, NOP
    addiu $v0, 1
    sw    $v0, 0x18+rt($fp)

loc_58:
; increment i:
    lw    $v0, 0x18+i($fp)
    or    $at, $zero ; load delay slot, NOP
    addiu $v0, 1
    sw    $v0, 0x18+i($fp)

loc_68:
; load i and compare it with 0x20 (32).
; jump to loc_20 if it is less then 0x20 (32):
    lw    $v0, 0x18+i($fp)
    or    $at, $zero ; load delay slot, NOP
    slti  $v0, 0x20 # ' '
    bnez  $v0, loc_20
    or    $at, $zero ; branch delay slot, NOP
; function epilogue. return rt:
    lw    $v0, 0x18+rt($fp)
    move  $sp, $fp ; load delay slot
    lw    $fp, 0x18+var_4($sp)
    addiu $sp, 0x18 ; load delay slot
    jr    $ra
    or    $at, $zero ; branch delay slot, NOP

```

That is verbose: all local variables are located in the local stack and reloaded each time they're needed. The SLLV instruction is "Shift Word Left Logical Variable", it differs from SLL only in that the shift amount is encoded in the SLL instruction (and is fixed, as a consequence), but SLLV takes shift amount from a register.

## Optimizing GCC

That is terser. There are two shift instructions instead of one. Why?

It's possible to replace the first SLLV instruction with an unconditional branch instruction that jumps right to the second SLLV. But this is another branching instruction in the function, and it's always favorable to get rid of them: [2.10.1 on page 466](#).

Listing 1.302: Optimizing GCC 4.4.5 (IDA)

```

f:
; $a0=a
; rt variable will reside in $v0:
    move  $v0, $zero
; i variable will reside in $v1:
    move  $v1, $zero
    li    $t0, 1
    li    $a3, 32
    sllv  $a1, $t0, $v1
; $a1 = $t0<<$v1 = 1<<i

```

```

loc_14:
        and    $a1, $a0
; $a1 = a&(1<<i)
; increment i:
        addiu  $v1, 1
; jump to loc_28 if a&(1<<i)==0 and increment rt:
        beqz  $a1, loc_28
        addiu  $a2, $v0, 1
; if BEQZ was not triggered, save updated rt into $v0:
        move  $v0, $a2

loc_28:
; if i!=32, jump to loc_14 and also prepare next shifted value:
        bne   $v1, $a3, loc_14
        sllv  $a1, $t0, $v1
; return
        jr    $ra
        or    $at, $zero ; branch delay slot, NOP

```

### 1.28.6 Conclusion

Analogous to the C/C++ shifting operators  $\ll$  and  $\gg$ , the shift instructions in x86 are SHR/SHL (for unsigned values) and SAR/SHL (for signed values).

The shift instructions in ARM are LSR/LSL (for unsigned values) and ASR/LSL (for signed values).

It's also possible to add shift suffix to some instructions (which are called "data processing instructions").

#### Check for specific bit (known at compile stage)

Test if the 0b1000000 bit (0x40) is present in the register's value:

Listing 1.303: C/C++

```

if (input&0x40)
    ...

```

Listing 1.304: x86

```

TEST REG, 40h
JNZ is_set
; bit is not set

```

Listing 1.305: x86

```

TEST REG, 40h
JZ is_cleared
; bit is set

```

Listing 1.306: ARM (ARM mode)

```

TST REG, #0x40
BNE is_set
; bit is not set

```

Sometimes, AND is used instead of TEST, but the flags that are set are the same.

#### Check for specific bit (specified at runtime)

This is usually done by this C/C++ code snippet (shift value by  $n$  bits right, then cut off lowest bit):

Listing 1.307: C/C++

```

if ((value>>n)&1)
    ....

```

This is usually implemented in x86 code as:

Listing 1.308: x86

```
; REG=input_value
; CL=n
SHR REG, CL
AND REG, 1
```

Or (shift 1 bit  $n$  times left, isolate this bit in input value and check if it's not zero):

Listing 1.309: C/C++

```
if (value & (1<<n))
    ....
```

This is usually implemented in x86 code as:

Listing 1.310: x86

```
; CL=n
MOV REG, 1
SHL REG, CL
AND input_value, REG
```

### Set specific bit (known at compile stage)

Listing 1.311: C/C++

```
value=value|0x40;
```

Listing 1.312: x86

```
OR REG, 40h
```

Listing 1.313: ARM (ARM mode) and ARM64

```
ORR R0, R0, #0x40
```

### Set specific bit (specified at runtime)

Listing 1.314: C/C++

```
value=value|(1<<n);
```

This is usually implemented in x86 code as:

Listing 1.315: x86

```
; CL=n
MOV REG, 1
SHL REG, CL
OR input_value, REG
```

### Clear specific bit (known at compile stage)

Just apply AND operation with the inverted value:

Listing 1.316: C/C++

```
value=value&(~0x40);
```

Listing 1.317: x86

```
AND REG, 0FFFFFFBFh
```

Listing 1.318: x64

```
AND REG, 0FFFFFFFFFFFFFFBFh
```

This is actually leaving all bits set except one.

ARM in ARM mode has BIC instruction, which works like the NOT +AND instruction pair:

Listing 1.319: ARM (ARM mode)

```
BIC R0, R0, #0x40
```

### Clear specific bit (specified at runtime)

Listing 1.320: C/C++

```
value=value&(~(1<<n));
```

Listing 1.321: x86

```
; CL=n
MOV REG, 1
SHL REG, CL
NOT REG
AND input_value, REG
```

## 1.28.7 Exercises

- <http://challenges.re/67>
- <http://challenges.re/68>
- <http://challenges.re/69>
- <http://challenges.re/70>

## 1.29 Linear congruential generator as pseudorandom number generator

Perhaps, the linear congruential generator is the simplest possible way to generate random numbers.

It's not in favour nowadays<sup>148</sup>, but it's so simple (just one multiplication, one addition and AND operation), that we can use it as an example.

```
#include <stdint.h>

// constants from the Numerical Recipes book
#define RNG_a 1664525
#define RNG_c 1013904223

static uint32_t rand_state;

void my_srand (uint32_t init)
{
    rand_state=init;
}
```

<sup>148</sup>Mersenne twister is better

```

int my_rand ()
{
    rand_state=rand_state*RNG_a;
    rand_state=rand_state+RNG_c;
    return rand_state & 0x7fff;
}

```

There are two functions: the first one is used to initialize the internal state, and the second one is called to generate pseudorandom numbers.

We see that two constants are used in the algorithm. They are taken from [William H. Press and Saul A. Teukolsky and William T. Vetterling and Brian P. Flannery, *Numerical Recipes*, (2007)].

Let's define them using a #define C/C++ statement. It's a macro.

The difference between a C/C++ macro and a constant is that all macros are replaced with their value by C/C++ preprocessor, and they don't take any memory, unlike variables.

In contrast, a constant is a read-only variable.

It's possible to take a pointer (or address) of a constant variable, but impossible to do so with a macro.

The last AND operation is needed because by C-standard my\_rand() has to return a value in the 0..32767 range.

If you want to get 32-bit pseudorandom values, just omit the last AND operation.

### 1.29.1 x86

Listing 1.322: Optimizing MSVC 2013

```

_BSS    SEGMENT
_rand_state DD  01H DUP (?)
_BSS    ENDS

_init$ = 8
_srand  PROC
        mov     eax, DWORD PTR _init$[esp-4]
        mov     DWORD PTR _rand_state, eax
        ret     0
_srand  ENDP

_TEXT   SEGMENT
_rand   PROC
        imul   eax, DWORD PTR _rand_state, 1664525
        add    eax, 1013904223 ; 3c6ef35fH
        mov    DWORD PTR _rand_state, eax
        and    eax, 32767      ; 00007fffH
        ret    0
_rand   ENDP
_TEXT   ENDS

```

Here we see it: both constants are embedded into the code. There is no memory allocated for them.

The my\_srand() function just copies its input value into the internal rand\_state variable.

my\_rand() takes it, calculates the next rand\_state, cuts it and leaves it in the EAX register.

The non-optimized version is more verbose:

Listing 1.323: Non-optimizing MSVC 2013

```

_BSS    SEGMENT
_rand_state DD  01H DUP (?)
_BSS    ENDS

_init$ = 8
_srand  PROC
        push   ebp
        mov    ebp, esp

```

```

        mov     eax, DWORD PTR _init$[ebp]
        mov     DWORD PTR _rand_state, eax
        pop     ebp
        ret     0
_srand  ENDP

_TEXT  SEGMENT
_rand  PROC
        push   ebp
        mov    ebp, esp
        imul  eax, DWORD PTR _rand_state, 1664525
        mov   DWORD PTR _rand_state, eax
        mov   ecx, DWORD PTR _rand_state
        add   ecx, 1013904223 ; 3c6ef35fH
        mov   DWORD PTR _rand_state, ecx
        mov   eax, DWORD PTR _rand_state
        and   eax, 32767      ; 00007fffH
        pop   ebp
        ret   0
_rand   ENDP

_TEXT  ENDS

```

## 1.29.2 x64

The x64 version is mostly the same and uses 32-bit registers instead of 64-bit ones (because we are working with *int* values here).

But `my_srand()` takes its input argument from the ECX register rather than from stack:

Listing 1.324: Optimizing MSVC 2013 x64

```

_BSS   SEGMENT
rand_state DD  01H DUP (?)
_BSS   ENDS

init$ = 8
my_srand PROC
; ECX = input argument
        mov   DWORD PTR rand_state, ecx
        ret   0
my_srand ENDP

_TEXT  SEGMENT
my_rand PROC
        imul  eax, DWORD PTR rand_state, 1664525 ; 0019660dH
        add   eax, 1013904223 ; 3c6ef35fH
        mov   DWORD PTR rand_state, eax
        and   eax, 32767      ; 00007fffH
        ret   0
my_rand ENDP

_TEXT  ENDS

```

GCC compiler generates mostly the same code.

## 1.29.3 32-bit ARM

Listing 1.325: Optimizing Keil 6/2013 (ARM mode)

```

my_srand PROC
        LDR    r1, |L0.52| ; load pointer to rand_state
        STR    r0, [r1, #0] ; save rand_state
        BX    lr
        ENDP

my_rand PROC
        LDR    r0, |L0.52| ; load pointer to rand_state
        LDR    r2, |L0.56| ; load RNG_a

```

```

    LDR    r1,[r0,#0] ; load rand_state
    MUL    r1,r2,r1
    LDR    r2,|L0.60| ; load RNG_c
    ADD    r1,r1,r2
    STR    r1,[r0,#0] ; save rand_state
; AND with 0x7FFF:
    LSL    r0,r1,#17
    LSR    r0,r0,#17
    BX     lr
    ENDP

|L0.52|
DCD     ||.data||
|L0.56|
DCD     0x0019660d
|L0.60|
DCD     0x3c6ef35f

    AREA  ||.data||, DATA, ALIGN=2

rand_state
DCD     0x00000000

```

It's not possible to embed 32-bit constants into ARM instructions, so Keil has to place them externally and load them additionally. One interesting thing is that it's not possible to embed the 0x7FFF constant as well. So what Keil does is shifting `rand_state` left by 17 bits and then shifting it right by 17 bits. This is analogous to the  $(rand\_state \ll 17) \gg 17$  statement in C/C++. It seems to be useless operation, but what it does is clearing the high 17 bits, leaving the low 15 bits intact, and that's our goal after all.

Optimizing Keil for Thumb mode generates mostly the same code.

## 1.29.4 MIPS

Listing 1.326: Optimizing GCC 4.4.5 (IDA)

```

my_srand:
; store $a0 to rand_state:
    lui    $v0, (rand_state >> 16)
    jr     $ra
    sw     $a0, rand_state

my_rand:
; load rand_state to $v0:
    lui    $v1, (rand_state >> 16)
    lw     $v0, rand_state
    or     $at, $zero ; load delay slot
; multiply rand_state in $v0 by 1664525 (RNG_a):
    sll   $a1, $v0, 2
    sll   $a0, $v0, 4
    addu  $a0, $a1, $a0
    sll   $a1, $a0, 6
    subu  $a0, $a1, $a0
    addu  $a0, $v0
    sll   $a1, $a0, 5
    addu  $a0, $a1
    sll   $a0, $a0, 3
    addu  $v0, $a0, $v0
    sll   $a0, $v0, 2
    addu  $v0, $a0

; add 1013904223 (RNG_c)
; the LI instruction is coalesced by IDA from LUI and ORI
    li    $a0, 0x3C6EF35F
    addu  $v0, $a0
; store to rand_state:
    sw    $v0, (rand_state & 0xFFFF)($v1)
    jr    $ra
    andi  $v0, 0x7FFF ; branch delay slot

```

Wow, here we see only one constant (0x3C6EF35F or 1013904223). Where is the other one (1664525)?



It seems that multiplication by 1664525 is performed by just using shifts and additions! Let's check this assumption:

```
#define RNG_a 1664525

int f (int a)
{
    return a*RNG_a;
}
```

Listing 1.327: Optimizing GCC 4.4.5 (IDA)

```
f:
        sll    $v1, $a0, 2
        sll    $v0, $a0, 4
        addu   $v0, $v1, $v0
        sll    $v1, $v0, 6
        subu   $v0, $v1, $v0
        addu   $v0, $a0
        sll    $v1, $v0, 5
        addu   $v0, $v1
        sll    $v0, $v0, 3
        addu   $a0, $v0, $a0
        sll    $v0, $a0, 2
        jr     $ra
        addu   $v0, $a0, $v0 ; branch delay slot
```

Indeed!

### MIPS relocations

We will also focus on how such operations as load from memory and store to memory actually work.

The listings here are produced by IDA, which hides some details.

We'll run objdump twice: to get a disassembled listing and also relocations list:

Listing 1.328: Optimizing GCC 4.4.5 (objdump)

```
# objdump -D rand_03.o

...

00000000 <my_srand>:
 0: 3c020000    lui    v0,0x0
 4: 03e00008    jr     ra
 8: ac440000    sw    a0,0(v0)

0000000c <my_rand>:
 c: 3c030000    lui    v1,0x0
10: 8c620000    lw     v0,0(v1)
14: 00200825    move   at,at
18: 00022880    sll    a1,v0,0x2
1c: 00022100    sll    a0,v0,0x4
20: 00a42021    addu   a0,a1,a0
24: 00042980    sll    a1,a0,0x6
28: 00a42023    subu   a0,a1,a0
2c: 00822021    addu   a0,a0,v0
30: 00042940    sll    a1,a0,0x5
34: 00852021    addu   a0,a0,a1
38: 000420c0    sll    a0,a0,0x3
3c: 00821021    addu   v0,a0,v0
40: 00022080    sll    a0,v0,0x2
44: 00441021    addu   v0,v0,a0
48: 3c043c6e    lui    a0,0x3c6e
4c: 3484f35f    ori    a0,a0,0xf35f
50: 00441021    addu   v0,v0,a0
54: ac620000    sw    v0,0(v1)
58: 03e00008    jr     ra
5c: 30427fff    andi   v0,v0,0x7fff
```

```

...
# objdump -r rand_03.o
...
RELOCATION RECORDS FOR [.text]:
OFFSET  TYPE          VALUE
00000000 R_MIPS_HI16      .bss
00000008 R_MIPS_L016      .bss
0000000c R_MIPS_HI16      .bss
00000010 R_MIPS_L016      .bss
00000054 R_MIPS_L016      .bss
...

```

Let's consider the two relocations for the `my_srand()` function.

The first one, for address 0 has a type of `R_MIPS_HI16` and the second one for address 8 has a type of `R_MIPS_L016`.

That implies that address of the beginning of the `.bss` segment is to be written into the instructions at address of 0 (high part of address) and 8 (low part of address).

The `rand_state` variable is at the very start of the `.bss` segment.

So we see zeros in the operands of instructions `LUI` and `SW`, because nothing is there yet— the compiler don't know what to write there.

The linker will fix this, and the high part of the address will be written into the operand of `LUI` and the low part of the address—to the operand of `SW`.

`SW` will sum up the low part of the address and what is in register `$V0` (the high part is there).

It's the same story with the `my_rand()` function: `R_MIPS_HI16` relocation instructs the linker to write the high part of the `.bss` segment address into instruction `LUI`.

So the high part of the `rand_state` variable address is residing in register `$V1`.

The `LW` instruction at address `0x10` sums up the high and low parts and loads the value of the `rand_state` variable into `$V0`.

The `SW` instruction at address `0x54` do the summing again and then stores the new value to the `rand_state` global variable.

IDA processes relocations while loading, thus hiding these details, but we should keep them in mind.

### 1.29.5 Thread-safe version of the example

The thread-safe version of the example is to be demonstrated later: [6.2.1 on page 744](#).

## 1.30 Structures

A C/C++ structure, with some assumptions, is just a set of variables, always stored in memory together, not necessary of the same type <sup>149</sup>.

### 1.30.1 MSVC: SYSTEMTIME example

Let's take the `SYSTEMTIME`<sup>150</sup> win32 structure that describes time.

This is how it's defined:

Listing 1.329: WinBase.h

```

typedef struct _SYSTEMTIME {
    WORD wYear;
    WORD wMonth;

```

<sup>149</sup>AKA "heterogeneous container"

<sup>150</sup>MSDN: [SYSTEMTIME structure](#)

```

WORD wDayOfWeek;
WORD wDay;
WORD wHour;
WORD wMinute;
WORD wSecond;
WORD wMilliseconds;
} SYSTEMTIME, *PSYSTEMTIME;

```

Let's write a C function to get the current time:

```

#include <windows.h>
#include <stdio.h>

void main()
{
    SYSTEMTIME t;
    GetSystemTime (&t);

    printf ("%04d-%02d-%02d %02d:%02d:%02d\n",
            t.wYear, t.wMonth, t.wDay,
            t.wHour, t.wMinute, t.wSecond);

    return;
};

```

We get (MSVC 2010):

Listing 1.330: MSVC 2010 /GS-

```

_t$ = -16 ; size = 16
_main      PROC
    push    ebp
    mov     ebp, esp
    sub     esp, 16
    lea    eax, DWORD PTR _t$[ebp]
    push    eax
    call   DWORD PTR __imp_GetSystemTime@4
    movzx  ecx, WORD PTR _t$[ebp+12] ; wSecond
    push    ecx
    movzx  edx, WORD PTR _t$[ebp+10] ; wMinute
    push    edx
    movzx  eax, WORD PTR _t$[ebp+8] ; wHour
    push    eax
    movzx  ecx, WORD PTR _t$[ebp+6] ; wDay
    push    ecx
    movzx  edx, WORD PTR _t$[ebp+2] ; wMonth
    push    edx
    movzx  eax, WORD PTR _t$[ebp] ; wYear
    push    eax
    push   OFFSET $SG78811 ; '%04d-%02d-%02d %02d:%02d:%02d', 0aH, 00H
    call   _printf
    add    esp, 28
    xor    eax, eax
    mov    esp, ebp
    pop    ebp
    ret    0
_main      ENDP

```

16 bytes are allocated for this structure in the local stack—that is exactly `sizeof(WORD)*8` (there are 8 WORD variables in the structure).

Pay attention to the fact that the structure begins with the `wYear` field. It can be said that a pointer to the `SYSTEMTIME` structure is passed to the `GetSystemTime()`<sup>151</sup>, but it is also can be said that a pointer to the `wYear` field is passed, and that is the same! `GetSystemTime()` writes the current year to the WORD pointer pointing to, then shifts 2 bytes ahead, writes current month, etc., etc.

<sup>151</sup>MSDN: [SYSTEMTIME structure](#)

## OlllyDbg

Let's compile this example in MSVC 2010 with /GS- /MD keys and run it in OlllyDbg.

Let's open windows for data and stack at the address which is passed as the first argument of the GetSystemTime() function, and let's wait until it's executed. We see this:

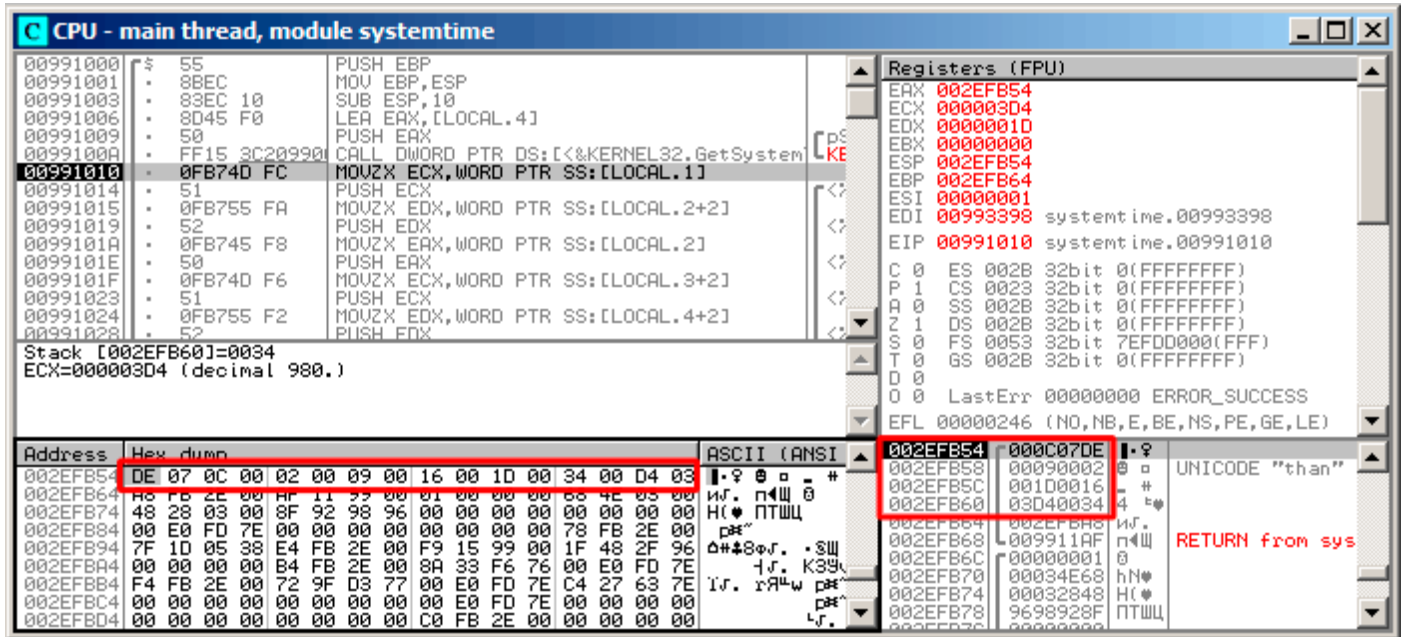

Figure 1.105: OlllyDbg: GetSystemTime() just executed

The system time of the function execution on my computer is 9 December 2014, 22:29:52:

Listing 1.331: printf() output

```
2014-12-09 22:29:52
```

So we see these 16 bytes in the data window:

```
DE 07 0C 00 02 00 09 00 16 00 1D 00 34 00 D4 03
```

Each two bytes represent one field of the structure. Since the **endianness** is *little endian*, we see the low byte first and then the high one.

Hence, these are the values currently stored in memory:

Hexadecimal number	decimal number	field name
0x07DE	2014	wYear
0x000C	12	wMonth
0x0002	2	wDayOfWeek
0x0009	9	wDay
0x0016	22	wHour
0x001D	29	wMinute
0x0034	52	wSecond
0x03D4	980	wMilliseconds

The same values are seen in the stack window, but they are grouped as 32-bit values.

And then printf() just takes the values it needs and outputs them to the console.

Some values aren't output by printf() (wDayOfWeek and wMilliseconds), but they are in memory right now, available for use.

## Replacing the structure with array

The fact that the structure fields are just variables located side-by-side, can be easily demonstrated by doing the following. Keeping in mind the SYSTEMTIME structure description, it's possible to rewrite this simple example like this:

```

#include <windows.h>
#include <stdio.h>

void main()
{
    WORD array[8];
    GetSystemTime (array);

    printf ("%04d-%02d-%02d %02d:%02d:%02d\n",
        array[0] /* wYear */, array[1] /* wMonth */, array[3] /* wDay */,
        array[4] /* wHour */, array[5] /* wMinute */, array[6] /* wSecond */);

    return;
};

```

The compiler grumbles a bit:

```

systemtime2.c(7) : warning C4133: 'function' : incompatible types - from 'WORD [8]' to 'LPSYSTEMTIME'

```

But nevertheless, it produces this code:

Listing 1.332: Non-optimizing MSVC 2010

```

$SG78573 DB      '%04d-%02d-%02d %02d:%02d:%02d', 0aH, 00H

_array$ = -16 ; size = 16
_main PROC
    push    ebp
    mov     ebp, esp
    sub     esp, 16
    lea    eax, DWORD PTR _array$[ebp]
    push   eax
    call   DWORD PTR __imp_GetSystemTime@4
    movzx  ecx, WORD PTR _array$[ebp+12] ; wSecond
    push   ecx
    movzx  edx, WORD PTR _array$[ebp+10] ; wMinute
    push   edx
    movzx  eax, WORD PTR _array$[ebp+8] ; wHour
    push   eax
    movzx  ecx, WORD PTR _array$[ebp+6] ; wDay
    push   ecx
    movzx  edx, WORD PTR _array$[ebp+2] ; wMonth
    push   edx
    movzx  eax, WORD PTR _array$[ebp] ; wYear
    push   eax
    push   OFFSET $SG78573 ; '%04d-%02d-%02d %02d:%02d:%02d', 0aH, 00H
    call   _printf
    add    esp, 28
    xor    eax, eax
    mov    esp, ebp
    pop    ebp
    ret    0
_main    ENDP

```

And it works just as the same!

It is very interesting that the result in assembly form cannot be distinguished from the result of the previous compilation.

So by looking at this code, one cannot say for sure if there was a structure declared, or an array.

Nevertheless, no sane person would do it, as it is not convenient.

Also the structure fields may be changed by developers, swapped, etc.

We will not study this example in OllyDbg, because it will be just the same as in the case with the structure.

## 1.30.2 Let's allocate space for a structure using malloc()

Sometimes it is simpler to place structures not the in local stack, but in the [heap](#):

```
#include <windows.h>
#include <stdio.h>

void main()
{
    SYSTEMTIME *t;

    t=(SYSTEMTIME *)malloc (sizeof (SYSTEMTIME));

    GetSystemTime (t);

    printf ("%04d-%02d-%02d %02d:%02d:%02d\n",
        t->wYear, t->wMonth, t->wDay,
        t->wHour, t->wMinute, t->wSecond);

    free (t);

    return;
};
```

Let's compile it now with optimization (/Ox) so it would be easy to see what we need.

Listing 1.333: Optimizing MSVC

```
_main      PROC
  push     esi
  push     16
  call    _malloc
  add     esp, 4
  mov     esi, eax
  push     esi
  call    DWORD PTR __imp_GetSystemTime@4
  movzx   eax, WORD PTR [esi+12] ; wSecond
  movzx   ecx, WORD PTR [esi+10] ; wMinute
  movzx   edx, WORD PTR [esi+8] ; wHour
  push    eax
  movzx   eax, WORD PTR [esi+6] ; wDay
  push    ecx
  movzx   ecx, WORD PTR [esi+2] ; wMonth
  push    edx
  movzx   edx, WORD PTR [esi] ; wYear
  push    eax
  push    ecx
  push    edx
  push    OFFSET $SG78833
  call    _printf
  push    esi
  call    _free
  add     esp, 32
  xor     eax, eax
  pop     esi
  ret     0
_main      ENDP
```

So, `sizeof(SYSTEMTIME) = 16` and that is exact number of bytes to be allocated by `malloc()`. It returns a pointer to a freshly allocated memory block in the EAX register, which is then moved into the ESI register. `GetSystemTime()` win32 function takes care of saving value in ESI, and that is why it is not saved here and continues to be used after the `GetSystemTime()` call.

New instruction —`MOVZX` (*Move with Zero eXtend*). It may be used in most cases as `MOVSB`, but it sets the remaining bits to 0. That's because `printf()` requires a 32-bit *int*, but we got a `WORD` in the structure — that is 16-bit unsigned type. That's why by copying the value from a `WORD` into *int*, bits from 16 to 31 must be cleared, because a random noise may be there, which is left from the previous operations on the register(s).

In this example, it's possible to represent the structure as an array of 8 `WORDS`:

```

#include <windows.h>
#include <stdio.h>

void main()
{
    WORD *t;

    t=(WORD *)malloc (16);

    GetSystemTime (t);

    printf ("%04d-%02d-%02d %02d:%02d:%02d\n",
        t[0] /* wYear */, t[1] /* wMonth */, t[3] /* wDay */,
        t[4] /* wHour */, t[5] /* wMinute */, t[6] /* wSecond */);

    free (t);

    return;
};

```

We get:

Listing 1.334: Optimizing MSVC

```

$SG78594 DB      '%04d-%02d-%02d %02d:%02d:%02d', 0aH, 00H

_main  PROC
      push     esi
      push     16
      call    _malloc
      add     esp, 4
      mov     esi, eax
      push    esi
      call   DWORD PTR __imp_GetSystemTime@4
      movzx  eax, WORD PTR [esi+12]
      movzx  ecx, WORD PTR [esi+10]
      movzx  edx, WORD PTR [esi+8]
      push   eax
      movzx  eax, WORD PTR [esi+6]
      push   ecx
      movzx  ecx, WORD PTR [esi+2]
      push   edx
      movzx  edx, WORD PTR [esi]
      push   eax
      push   ecx
      push   edx
      push   OFFSET $SG78594
      call   _printf
      push   esi
      call   _free
      add     esp, 32
      xor     eax, eax
      pop     esi
      ret     0
_main  ENDP

```

Again, we got the code that cannot be distinguished from the previous one.

And again it has to be noted, you haven't to do this in practice, unless you really know what you are doing.

### 1.30.3 UNIX: struct tm

#### Linux

Let's take the tm structure from time.h in Linux for example:

```

#include <stdio.h>
#include <time.h>

```

```

void main()
{
    struct tm t;
    time_t unix_time;

    unix_time=time(NULL);

    localtime_r (&unix_time, &t);

    printf ("Year: %d\n", t.tm_year+1900);
    printf ("Month: %d\n", t.tm_mon);
    printf ("Day: %d\n", t.tm_mday);
    printf ("Hour: %d\n", t.tm_hour);
    printf ("Minutes: %d\n", t.tm_min);
    printf ("Seconds: %d\n", t.tm_sec);
};

```

Let's compile it in GCC 4.4.1:

Listing 1.335: GCC 4.4.1

```

main proc near
    push    ebp
    mov     ebp, esp
    and     esp, 0FFFFFF0h
    sub     esp, 40h
    mov     dword ptr [esp], 0 ; first argument for time()
    call    time
    mov     [esp+3Ch], eax
    lea     eax, [esp+3Ch] ; take pointer to what time() returned
    lea     edx, [esp+10h] ; at ESP+10h struct tm will begin
    mov     [esp+4], edx ; pass pointer to the structure begin
    mov     [esp], eax ; pass pointer to result of time()
    call    localtime_r
    mov     eax, [esp+24h] ; tm_year
    lea     edx, [eax+76Ch] ; edx=eax+1900
    mov     eax, offset format ; "Year: %d\n"
    mov     [esp+4], edx
    mov     [esp], eax
    call    printf
    mov     edx, [esp+20h] ; tm_mon
    mov     eax, offset aMonthD ; "Month: %d\n"
    mov     [esp+4], edx
    mov     [esp], eax
    call    printf
    mov     edx, [esp+1Ch] ; tm_mday
    mov     eax, offset aDayD ; "Day: %d\n"
    mov     [esp+4], edx
    mov     [esp], eax
    call    printf
    mov     edx, [esp+18h] ; tm_hour
    mov     eax, offset aHourD ; "Hour: %d\n"
    mov     [esp+4], edx
    mov     [esp], eax
    call    printf
    mov     edx, [esp+14h] ; tm_min
    mov     eax, offset aMinutesD ; "Minutes: %d\n"
    mov     [esp+4], edx
    mov     [esp], eax
    call    printf
    mov     edx, [esp+10h]
    mov     eax, offset aSecondsD ; "Seconds: %d\n"
    mov     [esp+4], edx ; tm_sec
    mov     [esp], eax
    call    printf
    leave
    retn
main endp

```



Somehow, IDA did not write the local variables' names in the local stack. But since we already are experienced reverse engineers :- ) we may do it without this information in this simple example.

Please also pay attention to the `lea edx, [eax+76Ch]` —this instruction just adds 0x76C (1900) to value in EAX, but doesn't modify any flags. See also the relevant section about LEA ( [.1.6 on page 1029](#)).

## GDB

Let's try to load the example into GDB <sup>152</sup>:

Listing 1.336: GDB

```
dennis@ubuntuvm:~/polygon$ date
Mon Jun  2 18:10:37 EEST 2014
dennis@ubuntuvm:~/polygon$ gcc GCC_tm.c -o GCC_tm
dennis@ubuntuvm:~/polygon$ gdb GCC_tm
GNU gdb (GDB) 7.6.1-ubuntu
...
Reading symbols from /home/dennis/polygon/GCC_tm...(no debugging symbols found)...done.
(gdb) b printf
Breakpoint 1 at 0x8048330
(gdb) run
Starting program: /home/dennis/polygon/GCC_tm

Breakpoint 1, __printf (format=0x80485c0 "Year: %d\n") at printf.c:29
29  printf.c: No such file or directory.
(gdb) x/20x $esp
0xbffff0dc:  0x080484c3      0x080485c0      0x000007de      0x00000000
0xbffff0ec:  0x08048301      0x538c93ed      0x00000025      0x0000000a
0xbffff0fc:  0x00000012      0x00000002      0x00000005      0x00000072
0xbffff10c:  0x00000001      0x00000098      0x00000001      0x00002a30
0xbffff11c:  0x0804b090      0x08048530      0x00000000      0x00000000
(gdb)
```

We can easily find our structure in the stack. First, let's see how it's defined in *time.h*:

Listing 1.337: time.h

```
struct tm
{
    int    tm_sec;
    int    tm_min;
    int    tm_hour;
    int    tm_mday;
    int    tm_mon;
    int    tm_year;
    int    tm_wday;
    int    tm_yday;
    int    tm_isdst;
};
```

Pay attention that 32-bit *int* is used here instead of WORD in SYSTEMTIME. So, each field occupies 32-bit. Here are the fields of our structure in the stack:

```
0xbffff0dc:  0x080484c3      0x080485c0      0x000007de      0x00000000
0xbffff0ec:  0x08048301      0x538c93ed      0x00000025      sec 0x0000000a min
0xbffff0fc:  0x00000012      hour 0x00000002      mday 0x00000005      mon 0x00000072      year
0xbffff10c:  0x00000001      wday 0x00000098      yday 0x00000001      isdst0x00002a30
0xbffff11c:  0x0804b090      0x08048530      0x00000000      0x00000000
```

Or as a table:

<sup>152</sup>The *date* result is slightly corrected for demonstration purposes. Of course, it's not possible to run GDB that quickly, in the same second.

Hexadecimal number	decimal number	field name
0x00000025	37	tm_sec
0x0000000a	10	tm_min
0x00000012	18	tm_hour
0x00000002	2	tm_mday
0x00000005	5	tm_mon
0x00000072	114	tm_year
0x00000001	1	tm_wday
0x00000098	152	tm_yday
0x00000001	1	tm_isdst

Just like SYSTEMTIME ( [1.30.1 on page 344](#)),

there are also other fields available that are not used, like tm\_wday, tm\_yday, tm\_isdst.

## ARM

### Optimizing Keil 6/2013 (Thumb mode)

Same example:

Listing 1.338: Optimizing Keil 6/2013 (Thumb mode)

```

var_38 = -0x38
var_34 = -0x34
var_30 = -0x30
var_2C = -0x2C
var_28 = -0x28
var_24 = -0x24
timer  = -0xC

    PUSH    {LR}
    MOVS   R0, #0          ; timer
    SUB    SP, SP, #0x34
    BL     time
    STR    R0, [SP,#0x38+timer]
    MOV    R1, SP          ; tp
    ADD    R0, SP, #0x38+timer ; timer
    BL     localtime_r
    LDR    R1, =0x76C
    LDR    R0, [SP,#0x38+var_24]
    ADDS   R1, R0, R1
    ADR    R0, aYearD      ; "Year: %d\n"
    BL     __2printf
    LDR    R1, [SP,#0x38+var_28]
    ADR    R0, aMonthD     ; "Month: %d\n"
    BL     __2printf
    LDR    R1, [SP,#0x38+var_2C]
    ADR    R0, aDayD       ; "Day: %d\n"
    BL     __2printf
    LDR    R1, [SP,#0x38+var_30]
    ADR    R0, aHourD      ; "Hour: %d\n"
    BL     __2printf
    LDR    R1, [SP,#0x38+var_34]
    ADR    R0, aMinutesD   ; "Minutes: %d\n"
    BL     __2printf
    LDR    R1, [SP,#0x38+var_38]
    ADR    R0, aSecondsD   ; "Seconds: %d\n"
    BL     __2printf
    ADD    SP, SP, #0x34
    POP    {PC}

```

### Optimizing Xcode 4.6.3 (LLVM) (Thumb-2 mode)

IDA “knows” the tm structure (because IDA “knows” the types of the arguments of library functions like localtime\_r()),

so it shows here structure elements accesses and their names.

Listing 1.339: Optimizing Xcode 4.6.3 (LLVM) (Thumb-2 mode)

```

var_38 = -0x38
var_34 = -0x34

    PUSH {R7,LR}
    MOV  R7, SP
    SUB  SP, SP, #0x30
    MOVS R0, #0 ; time_t *
    BLX  _time
    ADD  R1, SP, #0x38+var_34 ; struct tm *
    STR  R0, [SP,#0x38+var_38]
    MOV  R0, SP ; time_t *
    BLX  _localtime_r
    LDR  R1, [SP,#0x38+var_34.tm_year]
    MOV  R0, 0xF44 ; "Year: %d\n"
    ADD  R0, PC ; char *
    ADDW R1, R1, #0x76C
    BLX  _printf
    LDR  R1, [SP,#0x38+var_34.tm_mon]
    MOV  R0, 0xF3A ; "Month: %d\n"
    ADD  R0, PC ; char *
    BLX  _printf
    LDR  R1, [SP,#0x38+var_34.tm_mday]
    MOV  R0, 0xF35 ; "Day: %d\n"
    ADD  R0, PC ; char *
    BLX  _printf
    LDR  R1, [SP,#0x38+var_34.tm_hour]
    MOV  R0, 0xF2E ; "Hour: %d\n"
    ADD  R0, PC ; char *
    BLX  _printf
    LDR  R1, [SP,#0x38+var_34.tm_min]
    MOV  R0, 0xF28 ; "Minutes: %d\n"
    ADD  R0, PC ; char *
    BLX  _printf
    LDR  R1, [SP,#0x38+var_34]
    MOV  R0, 0xF25 ; "Seconds: %d\n"
    ADD  R0, PC ; char *
    BLX  _printf
    ADD  SP, SP, #0x30
    POP  {R7,PC}

...

00000000 tm      struc ; (sizeof=0x2C, standard type)
00000000 tm_sec  DCD ?
00000004 tm_min  DCD ?
00000008 tm_hour DCD ?
0000000C tm_mday DCD ?
00000010 tm_mon  DCD ?
00000014 tm_year DCD ?
00000018 tm_wday DCD ?
0000001C tm_yday DCD ?
00000020 tm_isdst DCD ?
00000024 tm_gmtoff DCD ?
00000028 tm_zone DCD ? ; offset
0000002C tm      ends

```

## MIPS

Listing 1.340: Optimizing GCC 4.4.5 (IDA)

```

1 main:
2
3 ; IDA is not aware of structure field names, we named them manually:
4
5 var_40      = -0x40
6 var_38      = -0x38
7 seconds     = -0x34
8 minutes     = -0x30

```

```

9  hour          = -0x2C
10 day           = -0x28
11 month        = -0x24
12 year         = -0x20
13 var_4        = -4
14
15 lui          $gp, (__gnu_local_gp >> 16)
16 addiu       $sp, -0x50
17 la          $gp, (__gnu_local_gp & 0xFFFF)
18 sw          $ra, 0x50+var_4($sp)
19 sw          $gp, 0x50+var_40($sp)
20 lw          $t9, (time & 0xFFFF)($gp)
21 or          $at, $zero ; load delay slot, NOP
22 jalr        $t9
23 move        $a0, $zero ; branch delay slot, NOP
24 lw          $gp, 0x50+var_40($sp)
25 addiu       $a0, $sp, 0x50+var_38
26 lw          $t9, (localtime_r & 0xFFFF)($gp)
27 addiu       $a1, $sp, 0x50+seconds
28 jalr        $t9
29 sw          $v0, 0x50+var_38($sp) ; branch delay slot
30 lw          $gp, 0x50+var_40($sp)
31 lw          $a1, 0x50+year($sp)
32 lw          $t9, (printf & 0xFFFF)($gp)
33 la          $a0, $LC0          # "Year: %d\n"
34 jalr        $t9
35 addiu       $a1, 1900 ; branch delay slot
36 lw          $gp, 0x50+var_40($sp)
37 lw          $a1, 0x50+month($sp)
38 lw          $t9, (printf & 0xFFFF)($gp)
39 lui         $a0, ($LC1 >> 16) # "Month: %d\n"
40 jalr        $t9
41 la          $a0, ($LC1 & 0xFFFF) # "Month: %d\n" ; branch delay slot
42 lw          $gp, 0x50+var_40($sp)
43 lw          $a1, 0x50+day($sp)
44 lw          $t9, (printf & 0xFFFF)($gp)
45 lui         $a0, ($LC2 >> 16) # "Day: %d\n"
46 jalr        $t9
47 la          $a0, ($LC2 & 0xFFFF) # "Day: %d\n" ; branch delay slot
48 lw          $gp, 0x50+var_40($sp)
49 lw          $a1, 0x50+hour($sp)
50 lw          $t9, (printf & 0xFFFF)($gp)
51 lui         $a0, ($LC3 >> 16) # "Hour: %d\n"
52 jalr        $t9
53 la          $a0, ($LC3 & 0xFFFF) # "Hour: %d\n" ; branch delay slot
54 lw          $gp, 0x50+var_40($sp)
55 lw          $a1, 0x50+minutes($sp)
56 lw          $t9, (printf & 0xFFFF)($gp)
57 lui         $a0, ($LC4 >> 16) # "Minutes: %d\n"
58 jalr        $t9
59 la          $a0, ($LC4 & 0xFFFF) # "Minutes: %d\n" ; branch delay slot
60 lw          $gp, 0x50+var_40($sp)
61 lw          $a1, 0x50+seconds($sp)
62 lw          $t9, (printf & 0xFFFF)($gp)
63 lui         $a0, ($LC5 >> 16) # "Seconds: %d\n"
64 jalr        $t9
65 la          $a0, ($LC5 & 0xFFFF) # "Seconds: %d\n" ; branch delay slot
66 lw          $ra, 0x50+var_4($sp)
67 or          $at, $zero ; load delay slot, NOP
68 jr          $ra
69 addiu       $sp, 0x50
70
71 $LC0:        .ascii "Year: %d\n"<0>
72 $LC1:        .ascii "Month: %d\n"<0>
73 $LC2:        .ascii "Day: %d\n"<0>
74 $LC3:        .ascii "Hour: %d\n"<0>
75 $LC4:        .ascii "Minutes: %d\n"<0>
76 $LC5:        .ascii "Seconds: %d\n"<0>

```

This is an example where the branch delay slots can confuse us.

For example, there is the instruction `addiu $a1, 1900` at line 35 which adds 1900 to the year number. It's executed before the corresponding `JALR` at line 34, do not forget about it.

### Structure as a set of values

In order to illustrate that the structure is just variables laying side-by-side in one place, let's rework our example while looking at the `tm` structure definition again: listing.1.337.

```
#include <stdio.h>
#include <time.h>

void main()
{
    int tm_sec, tm_min, tm_hour, tm_mday, tm_mon, tm_year, tm_wday, tm_yday, tm_isdst;
    time_t unix_time;

    unix_time=time(NULL);

    localtime_r (&unix_time, &tm_sec);

    printf ("Year: %d\n", tm_year+1900);
    printf ("Month: %d\n", tm_mon);
    printf ("Day: %d\n", tm_mday);
    printf ("Hour: %d\n", tm_hour);
    printf ("Minutes: %d\n", tm_min);
    printf ("Seconds: %d\n", tm_sec);
};
```

N.B. The pointer to the `tm_sec` field is passed into `localtime_r`, i.e., to the first element of the "structure". The compiler warns us:

Listing 1.341: GCC 4.7.3

```
GCC_tm2.c: In function 'main':
GCC_tm2.c:11:5: warning: passing argument 2 of 'localtime_r' from incompatible pointer type [↵
↳ enabled by default]
In file included from GCC_tm2.c:2:0:
/usr/include/time.h:59:12: note: expected 'struct tm *' but argument is of type 'int *'
```

But nevertheless, it generates this:

Listing 1.342: GCC 4.7.3

```
main      proc near

var_30    = dword ptr -30h
var_2C    = dword ptr -2Ch
unix_time = dword ptr -1Ch
tm_sec    = dword ptr -18h
tm_min    = dword ptr -14h
tm_hour   = dword ptr -10h
tm_mday   = dword ptr -0Ch
tm_mon    = dword ptr -8
tm_year   = dword ptr -4

        push    ebp
        mov     ebp, esp
        and     esp, 0FFFFFFF0h
        sub     esp, 30h
        call   __main
        mov     [esp+30h+var_30], 0 ; arg 0
        call   time
        mov     [esp+30h+unix_time], eax
        lea    eax, [esp+30h+tm_sec]
        mov     [esp+30h+var_2C], eax
        lea    eax, [esp+30h+unix_time]
        mov     [esp+30h+var_30], eax
```

```

    call    localtime_r
    mov     eax, [esp+30h+tm_year]
    add     eax, 1900
    mov     [esp+30h+var_2C], eax
    mov     [esp+30h+var_30], offset aYearD ; "Year: %d\n"
    call    printf
    mov     eax, [esp+30h+tm_mon]
    mov     [esp+30h+var_2C], eax
    mov     [esp+30h+var_30], offset aMonthD ; "Month: %d\n"
    call    printf
    mov     eax, [esp+30h+tm_mday]
    mov     [esp+30h+var_2C], eax
    mov     [esp+30h+var_30], offset aDayD ; "Day: %d\n"
    call    printf
    mov     eax, [esp+30h+tm_hour]
    mov     [esp+30h+var_2C], eax
    mov     [esp+30h+var_30], offset aHourD ; "Hour: %d\n"
    call    printf
    mov     eax, [esp+30h+tm_min]
    mov     [esp+30h+var_2C], eax
    mov     [esp+30h+var_30], offset aMinutesD ; "Minutes: %d\n"
    call    printf
    mov     eax, [esp+30h+tm_sec]
    mov     [esp+30h+var_2C], eax
    mov     [esp+30h+var_30], offset aSecondsD ; "Seconds: %d\n"
    call    printf
    leave
    retn
main     endp

```

This code is identical to what we saw previously and it is not possible to say, was it a structure in original source code or just a pack of variables.

And this works. However, it is not recommended to do this in practice.

Usually, non-optimizing compilers allocates variables in the local stack in the same order as they were declared in the function.

Nevertheless, there is no guarantee.

By the way, some other compiler may warn about the `tm_year`, `tm_mon`, `tm_mday`, `tm_hour`, `tm_min` variables, but not `tm_sec` are used without being initialized.

Indeed, the compiler is not aware that these are to be filled by `localtime_r()` function.

We chose this example, since all structure fields are of type *int*.

This would not work if structure fields are 16-bit (WORD), like in the case of the `SYSTEMTIME` structure—`GetSystemTime()` will fill them incorrectly (because the local variables are aligned on a 32-bit boundary). Read more about it in next section: “Fields packing in structure” ([1.30.4 on page 359](#)).

So, a structure is just a pack of variables laying in one place, side-by-side. We could say that the structure is the instruction to the compiler, directing it to hold variables in one place. By the way, in some very early C versions (before 1972), there were no structures at all [Dennis M. Ritchie, *The development of the C language*, (1993)]<sup>153</sup>.

There is no debugger example here: it is just the same as you already saw.

## Structure as an array of 32-bit words

```

#include <stdio.h>
#include <time.h>

void main()
{
    struct tm t;
    time_t unix_time;
    int i;

```

<sup>153</sup>Also available as <http://go.yurichev.com/17264>

```

unix_time=time(NULL);

localtime_r (&unix_time, &t);

for (i=0; i<9; i++)
{
    int tmp=((int*)&t)[i];
    printf ("0x%08X (%d)\n", tmp, tmp);
};
};

```

We just cast a pointer to structure to an array of *int*'s. And that works! We run the example at 23:51:45 26-July-2014.

```

0x0000002D (45)
0x00000033 (51)
0x00000017 (23)
0x0000001A (26)
0x00000006 (6)
0x00000072 (114)
0x00000006 (6)
0x000000CE (206)
0x00000001 (1)

```

The variables here are in the same order as they are enumerated in the definition of the structure: [1.337 on page 351](#).

Here is how it gets compiled:

Listing 1.343: Optimizing GCC 4.8.1

```

main          proc near
              push    ebp
              mov     ebp, esp
              push   esi
              push   ebx
              and     esp, 0FFFFFFF0h
              sub     esp, 40h
              mov     dword ptr [esp], 0 ; timer
              lea    ebx, [esp+14h]
              call   _time
              lea    esi, [esp+38h]
              mov     [esp+4], ebx      ; tp
              mov     [esp+10h], eax
              lea    eax, [esp+10h]
              mov     [esp], eax       ; timer
              call   _localtime_r
              nop
              lea    esi, [esi+0]     ; NOP
loc_80483D8:
; EBX here is pointer to structure, ESI is the pointer to the end of it.
              mov     eax, [ebx]      ; get 32-bit word from array
              add     ebx, 4          ; next field in structure
              mov     dword ptr [esp+4], offset a0x08xD ; "0x%08X (%d)\n"
              mov     dword ptr [esp], 1
              mov     [esp+0Ch], eax  ; pass value to printf()
              mov     [esp+8], eax   ; pass value to printf()
              call   ___printf_chk
              cmp     ebx, esi       ; meet structure end?
              jnz    short loc_80483D8 ; no - load next value then
              lea    esp, [ebp-8]
              pop     ebx
              pop     esi
              pop     ebp
              retn
main          endp

```

Indeed: the space in the local stack is first treated as a structure, and then it's treated as an array.

It's even possible to modify the fields of the structure through this pointer.

And again, it's a dubiously hackish way to do things, not recommended for use in production code.

## Exercise

As an exercise, try to modify (increase by 1) the current month number, treating the structure as an array.

## Structure as an array of bytes

We can go even further. Let's cast the pointer to an array of bytes and dump it:

```
#include <stdio.h>
#include <time.h>

void main()
{
    struct tm t;
    time_t unix_time;
    int i, j;

    unix_time=time(NULL);

    localtime_r (&unix_time, &t);

    for (i=0; i<9; i++)
    {
        for (j=0; j<4; j++)
            printf ("0x%02X ", ((unsigned char*)&t)[i*4+j]);
        printf ("\n");
    }
};
```

```
0x2D 0x00 0x00 0x00
0x33 0x00 0x00 0x00
0x17 0x00 0x00 0x00
0x1A 0x00 0x00 0x00
0x06 0x00 0x00 0x00
0x72 0x00 0x00 0x00
0x06 0x00 0x00 0x00
0xCE 0x00 0x00 0x00
0x01 0x00 0x00 0x00
```

We also run this example at 23:51:45 26-July-2014 <sup>154</sup>. The values are just the same as in the previous dump ( [1.30.3 on the preceding page](#)), and of course, the lowest byte goes first, because this is a little-endian architecture ( [2.8 on page 464](#)).

Listing 1.344: Optimizing GCC 4.8.1

```
main          proc near
              push    ebp
              mov     ebp, esp
              push   edi
              push   esi
              push   ebx
              and     esp, 0FFFFFF0h
              sub     esp, 40h
              mov     dword ptr [esp], 0 ; timer
              lea    esi, [esp+14h]
              call   _time
              lea    edi, [esp+38h] ; struct end
              mov     [esp+4], esi ; tp
              mov     [esp+10h], eax
              lea    eax, [esp+10h]
              mov     [esp], eax ; timer
```

<sup>154</sup>The time and date are the same for demonstration purposes. Byte values are fixed up.



```

        call    _localtime_r
        lea    esi, [esi+0]    ; NOP
; ESI here is the pointer to structure in local stack. EDI is the pointer to structure end.
loc_8048408:
        xor    ebx, ebx        ; j=0

loc_804840A:
        movzx  eax, byte ptr [esi+ebx] ; load byte
        add    ebx, 1          ; j=j+1
        mov    dword ptr [esp+4], offset a0x02x ; "0x%02X "
        mov    dword ptr [esp], 1
        mov    [esp+8], eax    ; pass loaded byte to printf()
        call   __printf_chk
        cmp    ebx, 4
        jnz   short loc_804840A
; print carriage return character (CR)
        mov    dword ptr [esp], 0Ah ; c
        add    esi, 4
        call   _putchar
        cmp    esi, edi        ; meet struct end?
        jnz   short loc_8048408 ; j=0
        lea   esp, [ebp-0Ch]
        pop    ebx
        pop    esi
        pop    edi
        pop    ebp
        retn
main
        endp

```

## GNU Scientific Library: Representation of complex numbers

This is a relatively rare case when an array is used instead of a structure, on purpose:

### Representation of complex numbers

Complex numbers are represented using the type ``gsl_complex``. The internal representation of this type may vary across platforms and should not be accessed directly. The functions and macros described below allow complex numbers to be manipulated in a portable way.

For reference, the default form of the ``gsl_complex`` type is given by the following struct:

```

typedef struct
{
    double dat[2];
} gsl_complex;

```

The real and imaginary part are stored in contiguous elements of a two element array. This eliminates any padding between the real and imaginary parts, ``dat[0]`` and ``dat[1]``, allowing the struct to be mapped correctly onto packed complex arrays.

( <https://www.gnu.org/software/gsl/doc/html/complex.html#representation-of-complex-numbers> )

### 1.30.4 Fields packing in structure

One important thing is fields packing in structures.

Let's take a simple example:

```

#include <stdio.h>

struct s
{

```

```

char a;
int b;
char c;
int d;
};

void f(struct s s)
{
    printf ("a=%d; b=%d; c=%d; d=%d\n", s.a, s.b, s.c, s.d);
};

int main()
{
    struct s tmp;
    tmp.a=1;
    tmp.b=2;
    tmp.c=3;
    tmp.d=4;
    f(tmp);
};

```

As we see, we have two *char* fields (each is exactly one byte) and two more —*int* (each — 4 bytes).

## x86

This compiles to:

Listing 1.345: MSVC 2012 /GS- /Ob0

```

1  _tmp$ = -16
2  _main PROC
3      push    ebp
4      mov     ebp, esp
5      sub     esp, 16
6      mov     BYTE PTR _tmp$[ebp], 1      ; set field a
7      mov     DWORD PTR _tmp$[ebp+4], 2  ; set field b
8      mov     BYTE PTR _tmp$[ebp+8], 3   ; set field c
9      mov     DWORD PTR _tmp$[ebp+12], 4 ; set field d
10     sub     esp, 16                    ; allocate place for temporary structure
11     mov     eax, esp
12     mov     ecx, DWORD PTR _tmp$[ebp]  ; copy our structure to the temporary one
13     mov     DWORD PTR [eax], ecx
14     mov     edx, DWORD PTR _tmp$[ebp+4]
15     mov     DWORD PTR [eax+4], edx
16     mov     ecx, DWORD PTR _tmp$[ebp+8]
17     mov     DWORD PTR [eax+8], ecx
18     mov     edx, DWORD PTR _tmp$[ebp+12]
19     mov     DWORD PTR [eax+12], edx
20     call    _f
21     add     esp, 16
22     xor     eax, eax
23     mov     esp, ebp
24     pop     ebp
25     ret     0
26 _main ENDP
27
28 _s$ = 8 ; size = 16
29 ?f@@YAXUs@@@Z PROC ; f
30     push    ebp
31     mov     ebp, esp
32     mov     eax, DWORD PTR _s$[ebp+12]
33     push    eax
34     movsx   ecx, BYTE PTR _s$[ebp+8]
35     push    ecx
36     mov     edx, DWORD PTR _s$[ebp+4]
37     push    edx
38     movsx   eax, BYTE PTR _s$[ebp]
39     push    eax
40     push    OFFSET $SG3842
41     call    _printf

```

```

42     add     esp, 20
43     pop     ebp
44     ret     0
45 ?f@@YAXUs@@@Z ENDP ; f
46 _TEXT     ENDS

```

We pass the structure as a whole, but in fact, as we can see, the structure is being copied to a temporary one (a place in stack is allocated in line 10 for it, and then all 4 fields, one by one, are copied in lines 12 ... 19), and then its pointer (address) is to be passed.

The structure is copied because it's not known whether the `f()` function going to modify the structure or not. If it gets changed, then the structure in `main()` has to remain as it has been.

We could use C/C++ pointers, and the resulting code will be almost the same, but without the copying.

As we can see, each field's address is aligned on a 4-byte boundary. That's why each `char` occupies 4 bytes here (like `int`). Why? Because it is easier for the CPU to access memory at aligned addresses and to cache data from it.

However, it is not very economical.

Let's try to compile it with option (`/Zp1`) (`/Zp[n]` pack structures on n-byte boundary).

Listing 1.346: MSVC 2012 /GS- /Zp1

```

1  _main    PROC
2      push    ebp
3      mov     ebp, esp
4      sub     esp, 12
5      mov     BYTE PTR _tmp$[ebp], 1      ; set field a
6      mov     DWORD PTR _tmp$[ebp+1], 2  ; set field b
7      mov     BYTE PTR _tmp$[ebp+5], 3  ; set field c
8      mov     DWORD PTR _tmp$[ebp+6], 4  ; set field d
9      sub     esp, 12                    ; allocate place for temporary structure
10     mov     eax, esp
11     mov     ecx, DWORD PTR _tmp$[ebp]  ; copy 10 bytes
12     mov     DWORD PTR [eax], ecx
13     mov     edx, DWORD PTR _tmp$[ebp+4]
14     mov     DWORD PTR [eax+4], edx
15     mov     cx, WORD PTR _tmp$[ebp+8]
16     mov     WORD PTR [eax+8], cx
17     call    _f
18     add     esp, 12
19     xor     eax, eax
20     mov     esp, ebp
21     pop     ebp
22     ret     0
23 _main    ENDP
24
25 _TEXT    SEGMENT
26 _s$ = 8 ; size = 10
27 ?f@@YAXUs@@@Z PROC ; f
28     push    ebp
29     mov     ebp, esp
30     mov     eax, DWORD PTR _s$[ebp+6]
31     push    eax
32     movsx   ecx, BYTE PTR _s$[ebp+5]
33     push    ecx
34     mov     edx, DWORD PTR _s$[ebp+1]
35     push    edx
36     movsx   eax, BYTE PTR _s$[ebp]
37     push    eax
38     push    OFFSET $SG3842
39     call    _printf
40     add     esp, 20
41     pop     ebp
42     ret     0
43 ?f@@YAXUs@@@Z ENDP ; f

```

Now the structure takes only 10 bytes and each `char` value takes 1 byte. What does it give to us? Size economy. And as drawback —the CPU accessing these fields slower than it could.

The structure is also copied in `main()`. Not field-by-field, but directly 10 bytes, using three pairs of `MOV`. Why not 4?

The compiler decided that it's better to copy 10 bytes using 3 `MOV` pairs than to copy two 32-bit words and two bytes using 4 `MOV` pairs.

By the way, such copy implementation using `MOV` instead of calling the `memcpy()` function is widely used, because it's faster than a call to `memcpy()`—for short blocks, of course: [3.14.1 on page 515](#).

As it can be easily guessed, if the structure is used in many source and object files, all these must be compiled with the same convention about structures packing.

Aside from `MSVC /Zp` option which sets how to align each structure field, there is also the `#pragma pack` compiler option, which can be defined right in the source code. It is available in both `MSVC`<sup>155</sup> and `GCC`<sup>156</sup>.

Let's get back to the `SYSTEMTIME` structure that consists of 16-bit fields. How does our compiler know to pack them on 1-byte alignment boundary?

`WinNT.h` file has this:

Listing 1.347: `WinNT.h`

```
#include "pshpack1.h"
```

And this:

Listing 1.348: `WinNT.h`

```
#include "pshpack4.h"           // 4 byte packing is the default
```

The file `PshPack1.h` looks like:

Listing 1.349: `PshPack1.h`

```
#if ! (defined(lint) || defined(RC_INVOKED))
#if ( _MSC_VER >= 800 && !defined(_M_I86)) || defined(_PUSHPOP_SUPPORTED)
#pragma warning(disable:4103)
#if !(defined( MIDL_PASS )) || defined( __midl )
#pragma pack(push,1)
#else
#pragma pack(1)
#endif
#else
#pragma pack(1)
#endif
#endif /* ! (defined(lint) || defined(RC_INVOKED)) */
```

This tell the compiler how to pack the structures defined after `#pragma pack`.

<sup>155</sup>[MSDN: Working with Packing Structures](#)

<sup>156</sup>[Structure-Packing Pragma](#)s

## OllyDbg + fields are packed by default

Let's try our example (where the fields are aligned by default (4 bytes)) in OllyDbg:

The screenshot shows the CPU window with assembly code. The instruction at address 01371010 is `MOVSB EAX, BYTE PTR SS:[ARG.1]`. The registers window shows `EAX 00000004`. The stack window shows `Stack [0034FCB4]=01` and `EAX=4`. The data window shows a memory dump starting at address 0034FCB4 with the following hex values: 01 30 37 01 02 00 00 00 03 30 37 01 04 00 00 00. The ASCII column shows the characters '1', '0', '7', and '1' corresponding to the first four bytes.

Figure 1.106: OllyDbg: Before `printf()` execution

We see our 4 fields in the data window.

But where do the random bytes (0x30, 0x37, 0x01) come from, that are next to the first (a) and third (c) fields?

By looking at our listing 1.345 on page 360, we can see that the first and third fields are *char*, therefore only one byte is written, 1 and 3 respectively (lines 6 and 8).

The remaining 3 bytes of the 32-bit words are not being modified in memory! Hence, random garbage is left there.

This garbage doesn't influence the `printf()` output in any way, because the values for it are prepared using the `MOVSB` instruction, which takes bytes, not words: listing.1.345 (lines 34 and 38).

By the way, the `MOVSB` (sign-extending) instruction is used here, because *char* is signed by default in MSVC and GCC. If the unsigned `char` data type or `uint8_t` was used here, `MOVZB` instruction would have been used instead.

## OllyDbg + fields aligning on 1 byte boundary

Things are much clearer here: 4 fields occupy 10 bytes and the values are stored side-by-side

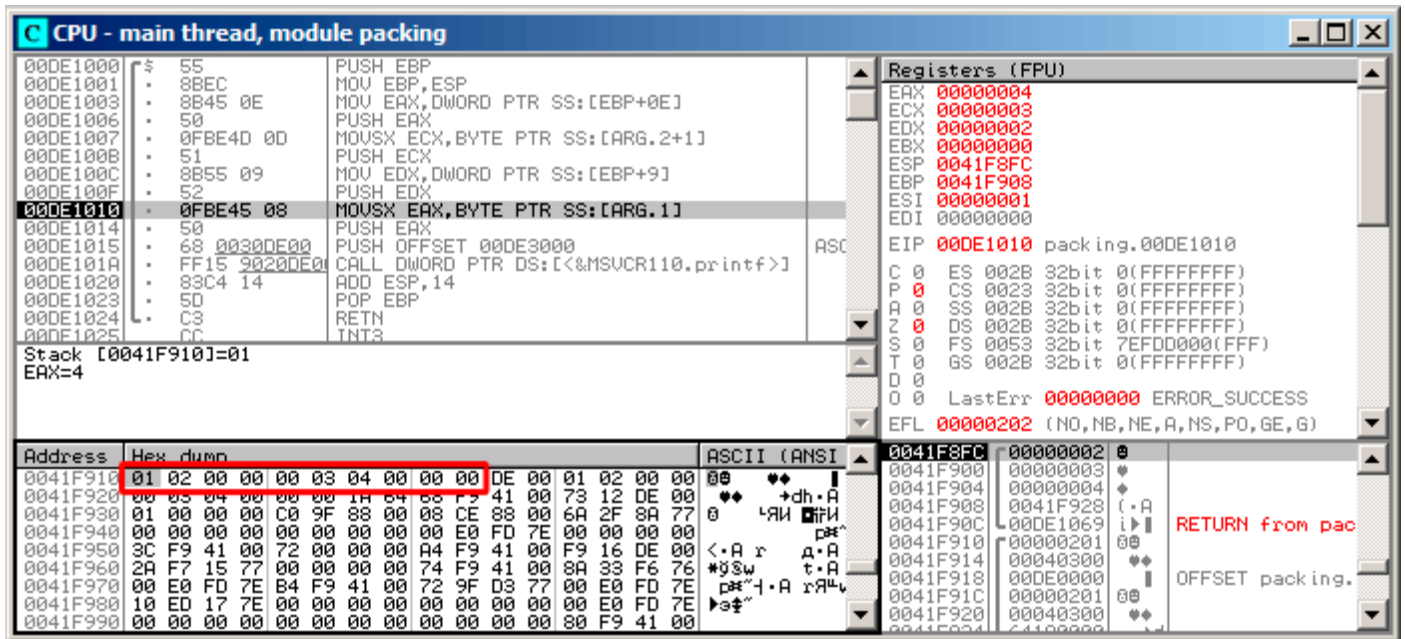

Figure 1.107: OllyDbg: Before printf() execution

## ARM

### Optimizing Keil 6/2013 (Thumb mode)

Listing 1.350: Optimizing Keil 6/2013 (Thumb mode)

```
.text:0000003E          exit ; CODE XREF: f+16
.text:0000003E 05 B0          ADD     SP, SP, #0x14
.text:00000040 00 BD          POP     {PC}

.text:00000280
.text:00000280
.text:00000280          f
.text:00000280          var_18 = -0x18
.text:00000280          a      = -0x14
.text:00000280          b      = -0x10
.text:00000280          c      = -0xC
.text:00000280          d      = -8
.text:00000280 0F B5          PUSH   {R0-R3,LR}
.text:00000282 81 B0          SUB    SP, SP, #4
.text:00000284 04 98          LDR   R0, [SP,#16] ; d
.text:00000286 02 9A          LDR   R2, [SP,#8] ; b
.text:00000288 00 90          STR   R0, [SP]
.text:0000028A 68 46          MOV   R0, SP
.text:0000028C 03 7B          LDRB  R3, [R0,#12] ; c
.text:0000028E 01 79          LDRB  R1, [R0,#4] ; a
.text:00000290 59 A0          ADR   R0, aADBDCDDD ; "a=%d; b=%d; c=%d; d=%d\n"
.text:00000292 05 F0 AD FF    BL    __2printf
.text:00000296 D2 E6          B     exit
```

As we may recall, here a structure is passed instead of pointer to one, and since the first 4 function arguments in ARM are passed via registers, the structure's fields are passed via R0-R3.

LDRB loads one byte from memory and extends it to 32-bit, taking its sign into account. This is similar to MOVSB in x86. Here it is used to load fields *a* and *c* from the structure.

One more thing we spot easily is that instead of function epilogue, there is jump to another function's epilogue! Indeed, that was quite different function, not related in any way to ours, however, it has exactly the same epilogue (probably because, it hold 5 local variables too ( $5 * 4 = 0x14$ )).

Also it is located nearby (take a look at the addresses).

Indeed, it doesn't matter which epilogue gets executed, if it works just as we need.

Apparently, Keil decides to reuse a part of another function to economize.

The epilogue takes 4 bytes while jump—only 2.

## ARM + Optimizing Xcode 4.6.3 (LLVM) (Thumb-2 mode)

Listing 1.351: Optimizing Xcode 4.6.3 (LLVM) (Thumb-2 mode)

```
var_C = -0xC

    PUSH   {R7,LR}
    MOV    R7, SP
    SUB    SP, SP, #4
    MOV    R9, R1 ; b
    MOV    R1, R0 ; a
    MOVW   R0, #0xF10 ; "a=%d; b=%d; c=%d; d=%d\n"
    SXTB   R1, R1 ; prepare a
    MOVT.W R0, #0
    STR    R3, [SP,#0xC+var_C] ; place d to stack for printf()
    ADD    R0, PC ; format-string
    SXTB   R3, R2 ; prepare c
    MOV    R2, R9 ; b
    BLX   _printf
    ADD    SP, SP, #4
    POP    {R7,PC}
```

SXTB (*Signed Extend Byte*) is analogous to MOVSB in x86. All the rest—just the same.

## MIPS

Listing 1.352: Optimizing GCC 4.4.5 (IDA)

```
1  f:
2
3  var_18      = -0x18
4  var_10     = -0x10
5  var_4      = -4
6  arg_0      = 0
7  arg_4      = 4
8  arg_8      = 8
9  arg_C      = 0xC
10
11 ; $a0=s.a
12 ; $a1=s.b
13 ; $a2=s.c
14 ; $a3=s.d
15         lui    $gp, (__gnu_local_gp >> 16)
16         addiu  $sp, -0x28
17         la    $gp, (__gnu_local_gp & 0xFFFF)
18         sw    $ra, 0x28+var_4($sp)
19         sw    $gp, 0x28+var_10($sp)
20 ; prepare a byte from 32-bit big-endian integer:
21         sra   $t0, $a0, 24
22         move  $v1, $a1
23 ; prepare a byte from 32-bit big-endian integer:
24         sra   $v0, $a2, 24
25         lw    $t9, (printf & 0xFFFF)($gp)
26         sw    $a0, 0x28+arg_0($sp)
27         lui  $a0, ($LC0 >> 16) # "a=%d; b=%d; c=%d; d=%d\n"
28         sw    $a3, 0x28+var_18($sp)
29         sw    $a1, 0x28+arg_4($sp)
30         sw    $a2, 0x28+arg_8($sp)
```

```

31         sw      $a3, 0x28+arg_C($sp)
32         la      $a0, ($LC0 & 0xFFFF) # "a=%d; b=%d; c=%d; d=%d\n"
33         move    $a1, $t0
34         move    $a2, $v1
35         jalr   $t9
36         move    $a3, $v0 ; branch delay slot
37         lw      $ra, 0x28+var_4($sp)
38         or      $at, $zero ; load delay slot, NOP
39         jr      $ra
40         addiu   $sp, 0x28 ; branch delay slot
41
42 $LC0:    .ascii "a=%d; b=%d; c=%d; d=%d\n"<0>

```

Structure fields come in registers \$A0..\$A3 and then get reshuffled into \$A1..\$A3 for printf(), while 4th field (from \$A3) is passed via local stack using SW.

But there are two SRA (“Shift Word Right Arithmetic”) instructions, which prepare *char* fields. Why?

MIPS is a big-endian architecture by default [2.8 on page 464](#), and the Debian Linux we work in is big-endian as well.

So when byte variables are stored in 32-bit structure slots, they occupy the high 31..24 bits.

And when a *char* variable needs to be extended into a 32-bit value, it must be shifted right by 24 bits.

*char* is a signed type, so an arithmetical shift is used here instead of logical.

### One more word

Passing a structure as a function argument (instead of a passing pointer to structure) is the same as passing all structure fields one by one.

If the structure fields are packed by default, the f() function can be rewritten as:

```

void f(char a, int b, char c, int d)
{
    printf ("a=%d; b=%d; c=%d; d=%d\n", a, b, c, d);
};

```

And that leads to the same code.

### 1.30.5 Nested structures

Now what about situations when one structure is defined inside of another?

```

#include <stdio.h>

struct inner_struct
{
    int a;
    int b;
};

struct outer_struct
{
    char a;
    int b;
    struct inner_struct c;
    char d;
    int e;
};

void f(struct outer_struct s)
{
    printf ("a=%d; b=%d; c.a=%d; c.b=%d; d=%d; e=%d\n",
           s.a, s.b, s.c.a, s.c.b, s.d, s.e);
};

int main()

```



```

{
    struct outer_struct s;
    s.a=1;
    s.b=2;
    s.c.a=100;
    s.c.b=101;
    s.d=3;
    s.e=4;
    f(s);
};

```

...in this case, both inner\_struct fields are to be placed between the a,b and d,e fields of the outer\_struct.  
Let's compile (MSVC 2010):

Listing 1.353: Optimizing MSVC 2010 /Ob0

```

$SG2802 DB    'a=%d; b=%d; c.a=%d; c.b=%d; d=%d; e=%d', 0aH, 00H

_TEXT      SEGMENT
_s$ = 8
_f        PROC
    mov     eax, DWORD PTR _s$[esp+16]
    movsx   ecx, BYTE PTR _s$[esp+12]
    mov     edx, DWORD PTR _s$[esp+8]
    push    eax
    mov     eax, DWORD PTR _s$[esp+8]
    push    ecx
    mov     ecx, DWORD PTR _s$[esp+8]
    push    edx
    movsx   edx, BYTE PTR _s$[esp+8]
    push    eax
    push    ecx
    push    edx
    push    OFFSET $SG2802 ; 'a=%d; b=%d; c.a=%d; c.b=%d; d=%d; e=%d'
    call    _printf
    add     esp, 28
    ret     0
_f        ENDP

_s$ = -24
_main     PROC
    sub     esp, 24
    push    ebx
    push    esi
    push    edi
    mov     ecx, 2
    sub     esp, 24
    mov     eax, esp
; from this moment, EAX is synonymous to ESP:
    mov     BYTE PTR _s$[esp+60], 1
    mov     ebx, DWORD PTR _s$[esp+60]
    mov     DWORD PTR [eax], ebx
    mov     DWORD PTR [eax+4], ecx
    lea    edx, DWORD PTR [ecx+98]
    lea    esi, DWORD PTR [ecx+99]
    lea    edi, DWORD PTR [ecx+2]
    mov     DWORD PTR [eax+8], edx
    mov     BYTE PTR _s$[esp+76], 3
    mov     ecx, DWORD PTR _s$[esp+76]
    mov     DWORD PTR [eax+12], esi
    mov     DWORD PTR [eax+16], ecx
    mov     DWORD PTR [eax+20], edi
    call   _f
    add     esp, 24
    pop     edi
    pop     esi
    xor     eax, eax
    pop     ebx
    add     esp, 24
    ret     0

```

```
_main    ENDP
```

One curious thing here is that by looking onto this assembly code, we do not even see that another structure was used inside of it! Thus, we would say, nested structures are unfolded into *linear* or *one-dimensional* structure.

Of course, if we replace the `struct inner_struct c;` declaration with `struct inner_struct *c;` (thus making a pointer here) the situation will be quite different.

## OllyDbg

Let's load the example into OllyDbg and take a look at `outer_struct` in memory:

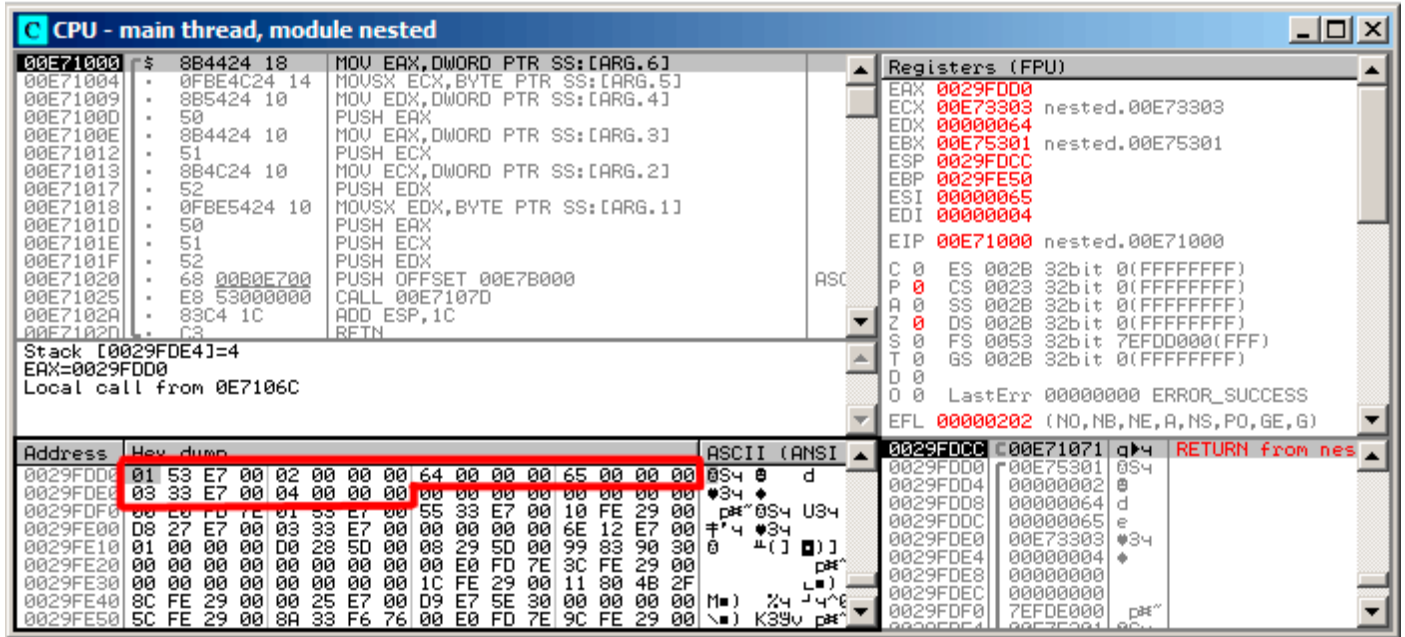

Figure 1.108: OllyDbg: Before `printf()` execution

That's how the values are located in memory:

- (`outer_struct.a`) (byte) 1 + 3 bytes of random garbage;
- (`outer_struct.b`) (32-bit word) 2;
- (`inner_struct.a`) (32-bit word) 0x64 (100);
- (`inner_struct.b`) (32-bit word) 0x65 (101);
- (`outer_struct.d`) (byte) 3 + 3 bytes of random garbage;
- (`outer_struct.e`) (32-bit word) 4.

### 1.30.6 Bit fields in a structure

#### CPUID example

The C/C++ language allows to define the exact number of bits for each structure field. It is very useful if one needs to save memory space. For example, one bit is enough for a `bool` variable. But of course, it is not rational if speed is important.

Let's consider the `CPUID`<sup>157</sup> instruction example. This instruction returns information about the current CPU and its features.

If the `EAX` is set to 1 before the instruction's execution, `CPUID` returning this information packed into the `EAX` register:

3:0 (4 bits)	Stepping
7:4 (4 bits)	Model
11:8 (4 bits)	Family
13:12 (2 bits)	Processor Type
19:16 (4 bits)	Extended Model
27:20 (8 bits)	Extended Family

MSVC 2010 has `CPUID` macro, but GCC 4.4.1 does not. So let's make this function by ourselves for GCC with the help of its built-in assembler<sup>158</sup>.

<sup>157</sup> [wikipedia](#)

<sup>158</sup> [More about internal GCC assembler](#)

```

#include <stdio.h>

#ifdef __GNUC__
static inline void cpuid(int code, int *a, int *b, int *c, int *d) {
    asm volatile("cpuid":"=a"(*a),"=b"(*b),"=c"(*c),"=d"(*d):"a"(code));
}
#endif

#ifdef _MSC_VER
#include <intrin.h>
#endif

struct CPUID_1_EAX
{
    unsigned int stepping:4;
    unsigned int model:4;
    unsigned int family_id:4;
    unsigned int processor_type:2;
    unsigned int reserved1:2;
    unsigned int extended_model_id:4;
    unsigned int extended_family_id:8;
    unsigned int reserved2:4;
};

int main()
{
    struct CPUID_1_EAX *tmp;
    int b[4];

#ifdef _MSC_VER
    __cpuid(b,1);
#endif

#ifdef __GNUC__
    cpuid (1, &b[0], &b[1], &b[2], &b[3]);
#endif

    tmp=(struct CPUID_1_EAX *)&b[0];

    printf ("stepping=%d\n", tmp->stepping);
    printf ("model=%d\n", tmp->model);
    printf ("family_id=%d\n", tmp->family_id);
    printf ("processor_type=%d\n", tmp->processor_type);
    printf ("extended_model_id=%d\n", tmp->extended_model_id);
    printf ("extended_family_id=%d\n", tmp->extended_family_id);

    return 0;
};

```

After CPUID fills EAX/EBX/ECX/EDX, these registers are to be written in the b[] array. Then, we have a pointer to the CPUID\_1\_EAX structure and we point it to the value in EAX from the b[] array.

In other words, we treat a 32-bit *int* value as a structure. Then we read specific bits from the structure.

## MSVC

Let's compile it in MSVC 2008 with /Ox option:

Listing 1.354: Optimizing MSVC 2008

```

_b$ = -16 ; size = 16
_main PROC
    sub    esp, 16
    push  ebx

    xor   ecx, ecx
    mov   eax, 1
    cpuid
    push  esi

```

```

lea    esi, DWORD PTR _b$[esp+24]
mov    DWORD PTR [esi], eax
mov    DWORD PTR [esi+4], ebx
mov    DWORD PTR [esi+8], ecx
mov    DWORD PTR [esi+12], edx

mov    esi, DWORD PTR _b$[esp+24]
mov    eax, esi
and    eax, 15
push   eax
push   OFFSET $SG15435 ; 'stepping=%d', 0aH, 00H
call   _printf

mov    ecx, esi
shr    ecx, 4
and    ecx, 15
push   ecx
push   OFFSET $SG15436 ; 'model=%d', 0aH, 00H
call   _printf

mov    edx, esi
shr    edx, 8
and    edx, 15
push   edx
push   OFFSET $SG15437 ; 'family_id=%d', 0aH, 00H
call   _printf

mov    eax, esi
shr    eax, 12
and    eax, 3
push   eax
push   OFFSET $SG15438 ; 'processor_type=%d', 0aH, 00H
call   _printf

mov    ecx, esi
shr    ecx, 16
and    ecx, 15
push   ecx
push   OFFSET $SG15439 ; 'extended_model_id=%d', 0aH, 00H
call   _printf

shr    esi, 20
and    esi, 255
push   esi
push   OFFSET $SG15440 ; 'extended_family_id=%d', 0aH, 00H
call   _printf
add    esp, 48
pop    esi

xor    eax, eax
pop    ebx

add    esp, 16
ret    0
_main  ENDP

```

The SHR instruction shifting the value in EAX by the number of bits that must be *skipped*, e.g., we ignore some bits *at the right side*.

The AND instruction clears the unneeded bits *on the left*, or, in other words, leaves only those bits in the EAX register we need.

## MSVC + OllyDbg

Let's load our example into OllyDbg and see, what values are set in EAX/EBX/ECX/EDX after the execution of CPUID:

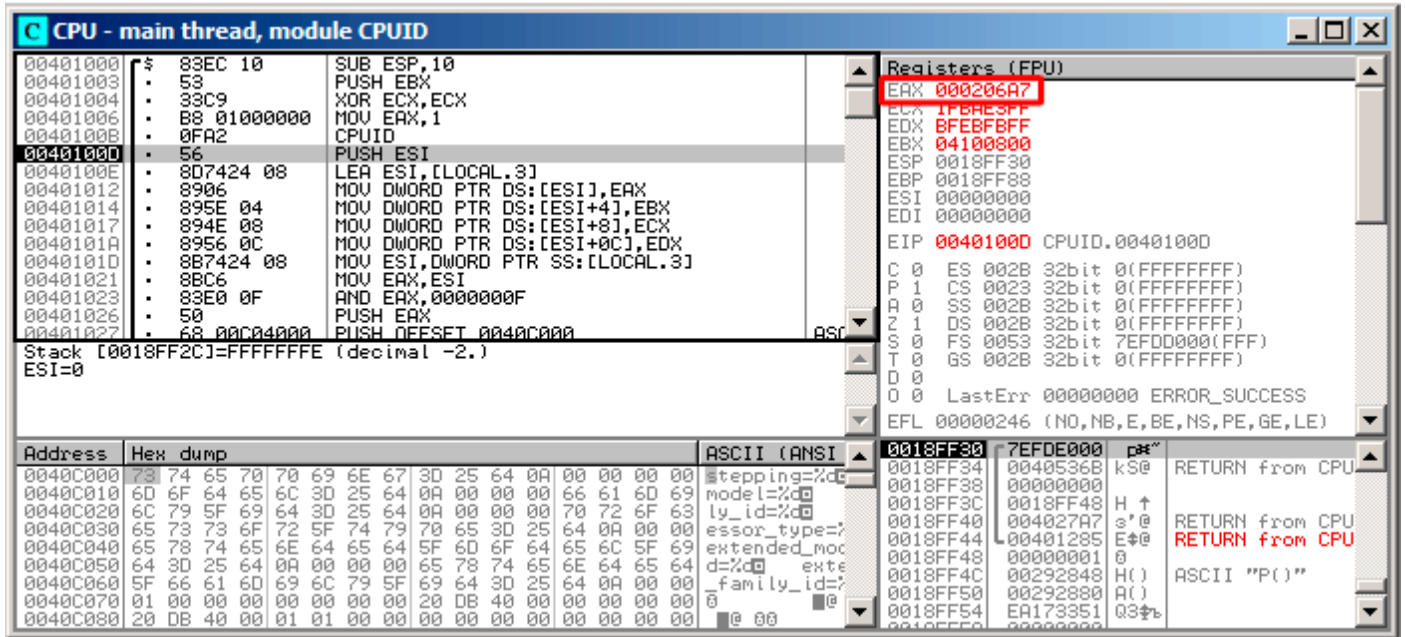

Figure 1.109: OllyDbg: After CPUID execution

EAX has 0x000206A7 (my CPU is Intel Xeon E3-1220).  
This is 0b00000000000000100000011010100111 in binary form.

Here is how the bits are distributed by fields:

field	in binary form	in decimal form
reserved2	0000	0
extended_family_id	00000000	0
extended_model_id	0010	2
reserved1	00	0
processor_id	00	0
family_id	0110	6
model	1010	10
stepping	0111	7

Listing 1.355: Console output

```

stepping=7
model=10
family_id=6
processor_type=0
extended_model_id=2
extended_family_id=0
    
```

## GCC

Let's try GCC 4.4.1 with -O3 option.

Listing 1.356: Optimizing GCC 4.4.1

```

main          proc near ; DATA XREF: _start+17
push         ebp
mov         ebp, esp
and         esp, 0FFFFFF0h
push         esi
mov         esi, 1
    
```

```

push    ebx
mov     eax, esi
sub     esp, 18h
cpuid
mov     esi, eax
and     eax, 0Fh
mov     [esp+8], eax
mov     dword ptr [esp+4], offset aSteppingD ; "stepping=%d\n"
mov     dword ptr [esp], 1
call    __printf_chk
mov     eax, esi
shr     eax, 4
and     eax, 0Fh
mov     [esp+8], eax
mov     dword ptr [esp+4], offset aModelD ; "model=%d\n"
mov     dword ptr [esp], 1
call    __printf_chk
mov     eax, esi
shr     eax, 8
and     eax, 0Fh
mov     [esp+8], eax
mov     dword ptr [esp+4], offset aFamily_idD ; "family_id=%d\n"
mov     dword ptr [esp], 1
call    __printf_chk
mov     eax, esi
shr     eax, 0Ch
and     eax, 3
mov     [esp+8], eax
mov     dword ptr [esp+4], offset aProcessor_type ; "processor_type=%d\n"
mov     dword ptr [esp], 1
call    __printf_chk
mov     eax, esi
shr     eax, 10h
shr     esi, 14h
and     eax, 0Fh
and     esi, 0FFh
mov     [esp+8], eax
mov     dword ptr [esp+4], offset aExtended_model ; "extended_model_id=%d\n"
mov     dword ptr [esp], 1
call    __printf_chk
mov     [esp+8], esi
mov     dword ptr [esp+4], offset unk_80486D0
mov     dword ptr [esp], 1
call    __printf_chk
add     esp, 18h
xor     eax, eax
pop     ebx
pop     esi
mov     esp, ebp
pop     ebp
retn
main    endp

```

Almost the same. The only thing worth noting is that GCC somehow combines the calculation of `extended_model_id` and `extended_family_id` into one block, instead of calculating them separately before each `printf()` call.

### Handling float data type as a structure

As we already noted in the section about FPU ( [1.25 on page 218](#)), both *float* and *double* types consist of a *sign*, a *significand* (or *fraction*) and an *exponent*. But will we be able to work with these fields directly? Let's try this with *float*.

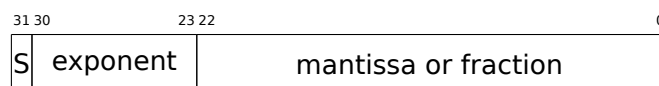

( S — sign )

```

#include <stdio.h>
#include <assert.h>
#include <stdlib.h>
#include <memory.h>

struct float_as_struct
{
    unsigned int fraction : 23; // fractional part
    unsigned int exponent : 8; // exponent + 0x3FF
    unsigned int sign : 1; // sign bit
};

float f(float _in)
{
    float f=_in;
    struct float_as_struct t;

    assert (sizeof (struct float_as_struct) == sizeof (float));

    memcpy (&t, &f, sizeof (float));

    t.sign=1; // set negative sign
    t.exponent=t.exponent+2; // multiply d by 2^n (n here is 2)

    memcpy (&f, &t, sizeof (float));

    return f;
};

int main()
{
    printf ("%f\n", f(1.234));
};

```

The `float_as_struct` structure occupies the same amount of memory as `float`, i.e., 4 bytes or 32 bits.

Now we are setting the negative sign in the input value and also, by adding 2 to the exponent, we thereby multiply the whole number by  $2^2$ , i.e., by 4.

Let's compile in MSVC 2008 without optimization turned on:

Listing 1.357: Non-optimizing MSVC 2008

```

_t$ = -8 ; size = 4
_f$ = -4 ; size = 4
__in$ = 8 ; size = 4
?f@YAMM@Z PROC ; f
    push    ebp
    mov     ebp, esp
    sub     esp, 8

    fld     DWORD PTR __in$[ebp]
    fstp   DWORD PTR _f$[ebp]

    push    4
    lea    eax, DWORD PTR _f$[ebp]
    push   eax
    lea    ecx, DWORD PTR _t$[ebp]
    push   ecx
    call   _memcpy
    add    esp, 12

    mov     edx, DWORD PTR _t$[ebp]
    or     edx, -2147483648 ; 80000000H - set minus sign
    mov     DWORD PTR _t$[ebp], edx

    mov     eax, DWORD PTR _t$[ebp]
    shr    eax, 23 ; 00000017H - drop significand
    and    eax, 255 ; 000000ffH - leave here only exponent
    add    eax, 2 ; add 2 to it

```



```

and    eax, 255          ; 000000ffH
shl    eax, 23          ; 00000017H - shift result to place of bits 30:23
mov    ecx, DWORD PTR _t$[ebp]
and    ecx, -2139095041 ; 807fffffH - drop exponent

; add original value without exponent with new calculated exponent:
or     ecx, eax
mov    DWORD PTR _t$[ebp], ecx

push   4
lea    edx, DWORD PTR _t$[ebp]
push   edx
lea    eax, DWORD PTR _f$[ebp]
push   eax
call   _memcpy
add    esp, 12

fld    DWORD PTR _f$[ebp]

mov    esp, ebp
pop    ebp
ret    0
?f@@YAMM@Z ENDP    ; f

```

A bit redundant. If it was compiled with /Ox flag there would be no memcpy() call, the f variable is used directly. But it is easier to understand by looking at the unoptimized version.

What would GCC 4.4.1 with -O3 do?

Listing 1.358: Optimizing GCC 4.4.1

```

; f(float)
public _Z1ff
_Z1ff proc near

var_4 = dword ptr -4
arg_0 = dword ptr 8

    push    ebp
    mov     ebp, esp
    sub     esp, 4
    mov     eax, [ebp+arg_0]
    or     eax, 80000000h ; set minus sign
    mov     edx, eax
    and    eax, 807FFFFFh ; leave only sign and significand in EAX
    shr    edx, 23        ; prepare exponent
    add    edx, 2         ; add 2
    movzx  edx, dl        ; clear all bits except 7:0 in EDX
    shl    edx, 23        ; shift new calculated exponent to its place
    or     eax, edx       ; join new exponent and original value without exponent
    mov     [ebp+var_4], eax
    fld    [ebp+var_4]
    leave
    retn

_Z1ff endp

public main
main proc near
    push    ebp
    mov     ebp, esp
    and    esp, 0FFFFFFF0h
    sub     esp, 10h
    fld    ds:dword_8048614 ; -4.936
    fstp   qword ptr [esp+8]
    mov    dword ptr [esp+4], offset asc_8048610 ; "%f\n"
    mov    dword ptr [esp], 1
    call   ___printf_chk
    xor    eax, eax
    leave
    retn

main endp

```

---

The `f()` function is almost understandable. However, what is interesting is that GCC was able to calculate the result of `f(1.234)` during compilation despite all this hodge-podge with the structure fields and prepared this argument to `printf()` as precalculated at compile time!

### 1.30.7 Exercises

- <http://challenges.re/71>
- <http://challenges.re/72>

## 1.31 The classic *struct* bug

This is a classic *struct* bug.

Here is a sample definition:

```
struct test
{
    int field1;
    int field2;
};
```

And then C files:

```
void setter(struct test *t, int a, int b)
{
    t->field1=a;
    t->field2=b;
};
```

```
#include <stdio.h>

void printer(struct test *t)
{
    printf ("%d\n", t->field1);
    printf ("%d\n", t->field2);
};
```

So far so good.

Now you add a third field into the structure, some place between two fields:

```
struct test
{
    int field1;
    int inserted;
    int field2;
};
```

And you probably modify `setter()` function, but forget about `printer()`:

```
void setter(struct test *t, int a, int b, int c)
{
    t->field1=a;
    t->inserted=b;
    t->field2=c;
};
```

You compile your project, but the C file where `printer()` is residing, isn't recompiling, because your IDE<sup>159</sup> or build system has no idea that module depends on a `test` struct definition. Maybe because `#include <new.h>` is omitted. Or maybe, `new.h` header file is included in `printer.c` via some other header file. The object file remains untouched (IDE thinks it doesn't need to be recompiled), while `setter()` function is already a new version. These two object files (old and new) eventually linked into an executable file.

---

<sup>159</sup>Integrated development environment

Then you run it, and the `setter()` sets 3 fields at +0, +4 and +8 offsets. However, the `printer()` only knows about 2 fields, and gets them from +0 and +4 offsets during printing.

This leads to very obscure and nasty bugs. The reason is that `IDE` or build system or `Makefile` doesn't know the fact that both C files (or modules) depends on the header file with `test` definition. A popular remedy is to clean everything and recompile.

This is true for C++ classes as well, since they works just like structures: [3.21.1 on page 545](#).

This is a C/C++'s malady, and a source of criticism, yes. Many newer `PLs` has better support of modules and interfaces. But keep in mind, when C compiler was created: 1970s, on old PDP computers. So everything was simplified down to this by C creators.

## 1.32 Unions

C/C++ `union` is mostly used for interpreting a variable (or memory block) of one data type as a variable of another data type.

### 1.32.1 Pseudo-random number generator example

If we need float random numbers between 0 and 1, the simplest thing is to use a `PRNG` like the Mersenne twister. It produces random unsigned 32-bit values (in other words, it produces random 32 bits). Then we can transform this value to `float` and then divide it by `RAND_MAX` (`0xFFFFFFFF` in our case)—we getting a value in the 0..1 interval.

But as we know, division is slow. Also, we would like to issue as few FPU operations as possible. Can we get rid of the division?

Let's recall what a floating point number consists of: sign bit, significand bits and exponent bits. We just have to store random bits in all significand bits to get a random float number!

The exponent cannot be zero (the floating number is denormalized in this case), so we are storing `0b01111111` to exponent—this means that the exponent is 1. Then we filling the significand with random bits, set the sign bit to 0 (which means a positive number) and voilà. The generated numbers is to be between 1 and 2, so we must also subtract 1.

A very simple linear congruential random numbers generator is used in my example<sup>160</sup>, it produces 32-bit numbers. The `PRNG` is initialized with the current time in UNIX timestamp format.

Here we represent the `float` type as an `union`—it is the C/C++ construction that enables us to interpret a piece of memory as different types. In our case, we are able to create a variable of type `union` and then access to it as it is `float` or as it is `uint32_t`. It can be said, it is just a hack. A dirty one.

The integer `PRNG` code is the same as we already considered: [1.29 on page 339](#). So this code in compiled form is omitted.

```
#include <stdio.h>
#include <stdint.h>
#include <time.h>

// integer PRNG definitions, data and routines:

// constants from the Numerical Recipes book
const uint32_t RNG_a=1664525;
const uint32_t RNG_c=1013904223;
uint32_t RNG_state; // global variable

void my_srand(uint32_t i)
{
    RNG_state=i;
};

uint32_t my_rand()
{
    RNG_state=RNG_state*RNG_a+RNG_c;
    return RNG_state;
};
```

<sup>160</sup>the idea was taken from: <http://go.yurichev.com/17308>

```

// FPU PRNG definitions and routines:

union uint32_t_float
{
    uint32_t i;
    float f;
};

float float_rand()
{
    union uint32_t_float tmp;
    tmp.i=my_rand() & 0x007fffff | 0x3F800000;
    return tmp.f-1;
};

// test

int main()
{
    my_srand(time(NULL)); // PRNG initialization

    for (int i=0; i<100; i++)
        printf ("%f\n", float_rand());

    return 0;
};

```

## x86

Listing 1.359: Optimizing MSVC 2010

```

$SG4238 DB      '%f', 0aH, 00H

__real@3fff000000000000 DQ 03fff00000000000r    ; 1

tv130 = -4
_tmp$ = -4
?float_rand@@YAMXZ PROC
    push    ecx
    call   ?my_rand@@YAIXZ
; EAX=pseudorandom value
    and    eax, 8388607          ; 007fffffH
    or     eax, 1065353216      ; 3f800000H
; EAX=pseudorandom value & 0x007fffff | 0x3f800000
; store it into local stack:
    mov    DWORD PTR _tmp$(esp+4), eax
; reload it as float point number:
    fld   DWORD PTR _tmp$(esp+4)
; subtract 1.0:
    fsub  QWORD PTR __real@3fff000000000000
; store value we got into local stack and reload it:
    fstp  DWORD PTR tv130[esp+4] ; \ these instructions are redundant
    fld  DWORD PTR tv130[esp+4] ; /
    pop   ecx
    ret   0
?float_rand@@YAMXZ ENDP

_main PROC
    push   esi
    xor   eax, eax
    call  _time
    push  eax
    call  ?my_srand@@YAXI@Z
    add  esp, 4
    mov  esi, 100
$LL3@main:
    call  ?float_rand@@YAMXZ
    sub  esp, 8
    fstp QWORD PTR [esp]

```

```

    push    OFFSET $SG4238
    call    _printf
    add     esp, 12
    dec     esi
    jne     SHORT $LL3@main
    xor     eax, eax
    pop     esi
    ret     0
_main     ENDP

```

Function names are so strange here because this example was compiled as C++ and this is name mangling in C++, we will talk about it later: [3.21.1 on page 547](#). If we compile this in MSVC 2012, it uses the SIMD instructions for the FPU, read more about it here: [1.38.5 on page 439](#).

## ARM (ARM mode)

Listing 1.360: Optimizing GCC 4.6.3 (IDA)

```

float_rand
    STMFD   SP!, {R3,LR}
    BL      my_rand
; R0=pseudorandom value
    FLDS   S0, =1.0
; S0=1.0
    BIC    R3, R0, #0xFF000000
    BIC    R3, R3, #0x800000
    ORR    R3, R3, #0x3F800000
; R3=pseudorandom value & 0x007fffff | 0x3f800000
; copy from R3 to FPU (register S15).
; it behaves like bitwise copy, no conversion done:
    FMSR   S15, R3
; subtract 1.0 and leave result in S0:
    FSUBS  S0, S15, S0
    LDMFD  SP!, {R3,PC}

flt_5C      DCFS 1.0

main
    STMFD   SP!, {R4,LR}
    MOV     R0, #0
    BL      time
    BL      my_srand
    MOV     R4, #0x64 ; 'd'

loc_78
    BL      float_rand
; S0=pseudorandom value
    LDR     R0, =aF ; "%f"
; convert float type value into double type value (printf() will need it):
    FCVTDS D7, S0
; bitwise copy from D7 into R2/R3 pair of registers (for printf()):
    FMRRD  R2, R3, D7
    BL      printf
    SUBS   R4, R4, #1
    BNE    loc_78
    MOV     R0, R4
    LDMFD  SP!, {R4,PC}

aF          DCB "%f",0xA,0

```

We'll also make a dump in objdump and we'll see that the FPU instructions have different names than in IDA. Apparently, IDA and binutils developers used different manuals? Perhaps it would be good to know both instruction name variants.

Listing 1.361: Optimizing GCC 4.6.3 (objdump)

```

00000038 <float_rand>:
 38: e92d4008   push    {r3, lr}
 3c: ebf7ffff   bl      10 <my_rand>

```

```

40:  ed9f0a05      vldr    s0, [pc, #20] ; 5c <float_rand+0x24>
44:  e3c034ff      bic     r3, r0, #-16777216 ; 0xff000000
48:  e3c33502      bic     r3, r3, #8388608 ; 0x800000
4c:  e38335fe      orr     r3, r3, #1065353216 ; 0x3f800000
50:  ee073a90      vmov   s15, r3
54:  ee370ac0      vsub.f32 s0, s15, s0
58:  e8bd8008      pop    {r3, pc}
5c:  3f800000      svccc  0x00800000

00000000 <main>:
0:   e92d4010      push   {r4, lr}
4:   e3a00000      mov    r0, #0
8:   ebfffffe      bl     0 <time>
c:   ebfffffe      bl     0 <main>
10:  e3a04064      mov    r4, #100 ; 0x64
14:  ebfffffe      bl     38 <main+0x38>
18:  e59f0018      ldr    r0, [pc, #24] ; 38 <main+0x38>
1c:  eeb77ac0      vcvf.f64.f32 d7, s0
20:  ec532b17      vmov  r2, r3, d7
24:  ebfffffe      bl     0 <printf>
28:  e2544001      subs  r4, r4, #1
2c:  lafffff8      bne   14 <main+0x14>
30:  e1a00004      mov    r0, r4
34:  e8bd8010      pop    {r4, pc}
38:  00000000      andeq r0, r0, r0

```

The instructions at 0x5c in `float_rand()` and at 0x38 in `main()` are (pseudo-)random noise.

### 1.32.2 Calculating machine epsilon

The machine epsilon is the smallest possible value the **FPU** can work with. The more bits allocated for floating point number, the smaller the machine epsilon. It is  $2^{-23} = 1.19e-07$  for *float* and  $2^{-52} = 2.22e-16$  for *double*. See also: [Wikipedia article](#).

It's interesting, how easy it's to calculate the machine epsilon:

```

#include <stdio.h>
#include <stdint.h>

union uint_float
{
    uint32_t i;
    float f;
};

float calculate_machine_epsilon(float start)
{
    union uint_float v;
    v.f=start;
    v.i++;
    return v.f-start;
}

void main()
{
    printf ("%g\n", calculate_machine_epsilon(1.0));
};

```

What we do here is just treat the fraction part of the IEEE 754 number as integer and add 1 to it. The resulting floating number is equal to *starting\_value+machine\_epsilon*, so we just have to subtract the starting value (using floating point arithmetic) to measure, what difference one bit reflects in the single precision (*float*). The *union* serves here as a way to access IEEE 754 number as a regular integer. Adding 1 to it in fact adds 1 to the *fraction* part of the number, however, needless to say, overflow is possible, which will add another 1 to the exponent part.

**x86**

Listing 1.362: Optimizing MSVC 2010

```

tv130 = 8
_v$ = 8
_start$ = 8
_calculate_machine_epsilon PROC
    fld     DWORD PTR _start$[esp-4]
    fst     DWORD PTR _v$[esp-4]      ; this instruction is redundant
    inc     DWORD PTR _v$[esp-4]
    fsubr   DWORD PTR _v$[esp-4]
    fstp    DWORD PTR tv130[esp-4]   ; \ this instruction pair is also redundant
    fld     DWORD PTR tv130[esp-4]   ; /
    ret     0
_calculate_machine_epsilon ENDP

```

The second FST instruction is redundant: there is no necessity to store the input value in the same place (the compiler decided to allocate the *v* variable at the same point in the local stack as the input argument). Then it is incremented with INC, as it is a normal integer variable. Then it is loaded into the FPU as a 32-bit IEEE 754 number, FSUBR does the rest of job and the resulting value is stored in ST0. The last FSTP/FLD instruction pair is redundant, but the compiler didn't optimize it out.

## ARM64

Let's extend our example to 64-bit:

```

#include <stdio.h>
#include <stdint.h>

typedef union
{
    uint64_t i;
    double d;
} uint_double;

double calculate_machine_epsilon(double start)
{
    uint_double v;
    v.d=start;
    v.i++;
    return v.d-start;
}

void main()
{
    printf ("%g\n", calculate_machine_epsilon(1.0));
};

```

ARM64 has no instruction that can add a number to a FPU D-register, so the input value (that came in D0) is first copied into GPR, incremented, copied to FPU register D1, and then subtraction occurs.

Listing 1.363: Optimizing GCC 4.9 ARM64

```

calculate_machine_epsilon:
    fmov    x0, d0      ; load input value of double type into X0
    add     x0, x0, 1   ; X0++
    fmov    d1, x0     ; move it to FPU register
    fsub    d0, d1, d0 ; subtract
    ret

```

See also this example compiled for x64 with SIMD instructions: [1.38.4 on page 438](#).

## MIPS

The new instruction here is MTC1 ("Move To Coprocessor 1"), it just transfers data from GPR to the FPU's registers.

Listing 1.364: Optimizing GCC 4.4.5 (IDA)

```

calculate_machine_epsilon:
    mfc1    $v0, $f12

```

```

or      $at, $zero ; NOP
addiu   $v1, $v0, 1
mtc1    $v1, $f2
jr      $ra
sub.s   $f0, $f2, $f12 ; branch delay slot

```

## Conclusion

It's hard to say whether someone may need this trickery in real-world code, but as was mentioned many times in this book, this example serves well for explaining the IEEE 754 format and *unions* in C/C++.

### 1.32.3 FSCALE instruction replacement

Agner Fog in his *Optimizing subroutines in assembly language / An optimization guide for x86 platforms* work <sup>161</sup> states that FSCALE FPU instruction (calculating  $2^n$ ) may be slow on many CPUs, and he offers faster replacement.

Here is my translation of his assembly code to C/C++:

```

#include <stdint.h>
#include <stdio.h>

union uint_float
{
    uint32_t i;
    float f;
};

float flt_2n(int N)
{
    union uint_float tmp;

    tmp.i=(N<<23)+0x3f800000;
    return tmp.f;
};

struct float_as_struct
{
    unsigned int fraction : 23;
    unsigned int exponent : 8;
    unsigned int sign : 1;
};

float flt_2n_v2(int N)
{
    struct float_as_struct tmp;

    tmp.fraction=0;
    tmp.sign=0;
    tmp.exponent=N+0x7f;
    return *(float*)&tmp;
};

union uint64_double
{
    uint64_t i;
    double d;
};

double dbl_2n(int N)
{
    union uint64_double tmp;

    tmp.i=((uint64_t)N<<52)+0x3ff0000000000000UL;
    return tmp.d;
};

```

<sup>161</sup>[http://www.agner.org/optimize/optimizing\\_assembly.pdf](http://www.agner.org/optimize/optimizing_assembly.pdf)



```

struct double_as_struct
{
    uint64_t fraction : 52;
    int exponent : 11;
    int sign : 1;
};

double dbl_2n_v2(int N)
{
    struct double_as_struct tmp;

    tmp.fraction=0;
    tmp.sign=0;
    tmp.exponent=N+0x3ff;
    return *(double*)&tmp;
};

int main()
{
    // 211 = 2048
    printf ("%f\n", flt_2n(11));
    printf ("%f\n", flt_2n_v2(11));
    printf ("%lf\n", dbl_2n(11));
    printf ("%lf\n", dbl_2n_v2(11));
};

```

FSCALE instruction may be faster in your environment, but still, it's a good example of *union*'s and the fact that exponent is stored in  $2^n$  form, so an input  $n$  value is shifted to the exponent in IEEE 754 encoded number. Then exponent is then corrected with addition of 0x3f800000 or 0x3ff0000000000000.

The same can be done without shift using *struct*, but internally, shift operations still occurred.

### 1.32.4 Fast square root calculation

Another well-known algorithm where *float* is interpreted as integer is fast calculation of square root.

Listing 1.365: The source code is taken from Wikipedia: <http://go.yurichev.com/17364>

```

/* Assumes that float is in the IEEE 754 single precision floating point format
 * and that int is 32 bits. */
float sqrt_approx(float z)
{
    int val_int = *(int*)&z; /* Same bits, but as an int */
    /*
     * To justify the following code, prove that
     *
     * (((val_int / 2^m) - b) / 2) + b) * 2^m = ((val_int - 2^m) / 2) + ((b + 1) / 2) * 2^m
     *
     * where
     *
     * b = exponent bias
     * m = number of mantissa bits
     *
     * .
     */

    val_int -= 1 << 23; /* Subtract 2^m. */
    val_int >>= 1; /* Divide by 2. */
    val_int += 1 << 29; /* Add ((b + 1) / 2) * 2^m. */

    return *(float*)&val_int; /* Interpret again as float */
}

```

As an exercise, you can try to compile this function and to understand, how it works.

There is also well-known algorithm of fast calculation of  $\frac{1}{\sqrt{x}}$ . Algorithm became popular, supposedly, because it was used in Quake III Arena.

Algorithm description can be found in Wikipedia: <http://go.yurichev.com/17360>.

## 1.33 Pointers to functions

A pointer to a function, as any other pointer, is just the address of the function's start in its code segment. They are often used for calling callback functions.

Well-known examples are:

- `qsort()`, `atexit()` from the standard C library;
- \*NIX OS signals.
- thread starting: `CreateThread()` (win32), `pthread_create()` (POSIX);
- lots of win32 functions, like `EnumChildWindows()`.
- lots of places in the Linux kernel, for example the filesystem driver functions are called via callbacks.
- The GCC plugin functions are also called via callbacks.

So, the `qsort()` function is an implementation of quicksort in the C/C++ standard library. The function is able to sort anything, any type of data, as long as you have a function to compare these two elements and `qsort()` is able to call it.

The comparison function can be defined as:

```
int (*compare)(const void *, const void *)
```

Let's use the following example:

```
1  /* ex3 Sorting ints with qsort */
2
3  #include <stdio.h>
4  #include <stdlib.h>
5
6  int comp(const void * _a, const void * _b)
7  {
8      const int *a=(const int *)_a;
9      const int *b=(const int *)_b;
10
11     if (*a==*b)
12         return 0;
13     else
14         if (*a < *b)
15             return -1;
16         else
17             return 1;
18 }
19
20 int main(int argc, char* argv[])
21 {
22     int numbers[10]={1892,45,200,-98,4087,5,-12345,1087,88,-100000};
23     int i;
24
25     /* Sort the array */
26     qsort(numbers,10,sizeof(int),comp) ;
27     for (i=0;i<9;i++)
28         printf("Number = %d\n",numbers[ i ] ) ;
29     return 0;
30 }
```

### 1.33.1 MSVC

Let's compile it in MSVC 2010 (some parts were omitted for the sake of brevity) with `/Ox` option:

Listing 1.366: Optimizing MSVC 2010: /GS- /MD

```

__a$ = 8 ; size = 4
__b$ = 12 ; size = 4
_comp PROC
    mov     eax, DWORD PTR __a$[esp-4]
    mov     ecx, DWORD PTR __b$[esp-4]
    mov     eax, DWORD PTR [eax]
    mov     ecx, DWORD PTR [ecx]
    cmp     eax, ecx
    jne     SHORT $LN4@comp
    xor     eax, eax
    ret     0
$LN4@comp:
    xor     edx, edx
    cmp     eax, ecx
    setge   dl
    lea    eax, DWORD PTR [edx+edx-1]
    ret     0
_comp ENDP

_numbers$ = -40 ; size = 40
_argc$ = 8 ; size = 4
_argv$ = 12 ; size = 4
_main PROC
    sub     esp, 40 ; 00000028H
    push   esi
    push   OFFSET _comp
    push   4
    lea    eax, DWORD PTR _numbers$[esp+52]
    push   10 ; 0000000aH
    push   eax
    mov    DWORD PTR _numbers$[esp+60], 1892 ; 00000764H
    mov    DWORD PTR _numbers$[esp+64], 45 ; 0000002dH
    mov    DWORD PTR _numbers$[esp+68], 200 ; 000000c8H
    mov    DWORD PTR _numbers$[esp+72], -98 ; ffffffff9eH
    mov    DWORD PTR _numbers$[esp+76], 4087 ; 00000ff7H
    mov    DWORD PTR _numbers$[esp+80], 5
    mov    DWORD PTR _numbers$[esp+84], -12345 ; fffffcfc7H
    mov    DWORD PTR _numbers$[esp+88], 1087 ; 0000043fH
    mov    DWORD PTR _numbers$[esp+92], 88 ; 00000058H
    mov    DWORD PTR _numbers$[esp+96], -100000 ; fffe7960H
    call   _qsort
    add    esp, 16 ; 00000010H
...

```

Nothing surprising so far. As a fourth argument, the address of label `_comp` is passed, which is just a place where `comp()` is located, or, in other words, the address of the very first instruction of that function.

How does `qsort()` call it?

Let's take a look at this function, located in `MSVCR80.DLL` (a MSVC DLL module with C standard library functions):

Listing 1.367: `MSVCR80.DLL`

```

.text:7816CBF0 ; void __cdecl qsort(void *, unsigned int, unsigned int, int (__cdecl *)(const
        void *, const void *))
.text:7816CBF0 public _qsort
.text:7816CBF0 _qsort proc near
.text:7816CBF0 lo = dword ptr -104h
.text:7816CBF0 hi = dword ptr -100h
.text:7816CBF0 var_FC = dword ptr -0FCh
.text:7816CBF0 stkptr = dword ptr -0F8h
.text:7816CBF0 lostk = dword ptr -0F4h
.text:7816CBF0 histk = dword ptr -7Ch
.text:7816CBF0 base = dword ptr 4
.text:7816CBF0 num = dword ptr 8
.text:7816CBF0 width = dword ptr 0Ch

```

```

.text:7816CBF0 comp          = dword ptr 10h
.text:7816CBF0
.text:7816CBF0          sub     esp, 100h

....

.text:7816CCE0 loc_7816CCE0:          ; CODE XREF: _qsort+B1
.text:7816CCE0          shr     eax, 1
.text:7816CCE2          imul  eax, ebp
.text:7816CCE5          add    eax, ebx
.text:7816CCE7          mov    edi, eax
.text:7816CCE9          push  edi
.text:7816CCEA          push  ebx
.text:7816CCEB          call  [esp+118h+comp]
.text:7816CCF2          add    esp, 8
.text:7816CCF5          test  eax, eax
.text:7816CCF7          jle   short loc_7816CD04

```

comp—is the fourth function argument. Here the control gets passed to the address in the comp argument. Before it, two arguments are prepared for comp(). Its result is checked after its execution.

That’s why it is dangerous to use pointers to functions. First of all, if you call qsort() with an incorrect function pointer, qsort() may pass control flow to an incorrect point, the process may crash and this bug will be hard to find.

The second reason is that the callback function types must comply strictly, calling the wrong function with wrong arguments of wrong types may lead to serious problems, however, the crashing of the process is not a problem here —the problem is how to determine the reason for the crash —because the compiler may be silent about the potential problems while compiling.

## MSVC + OllyDbg

Let's load our example into OllyDbg and set a breakpoint on `comp()`. We can see how the values are compared at the first `comp()` call:

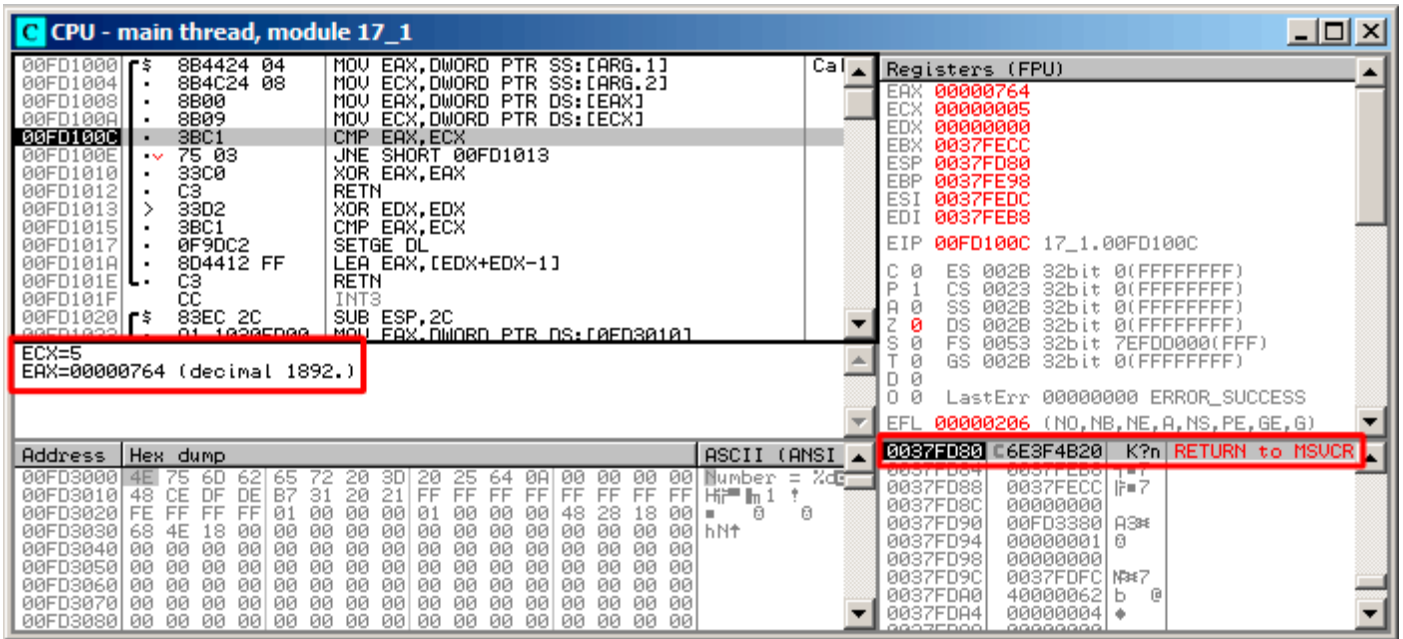

The screenshot displays the OllyDbg interface for the CPU window of the main thread in module 17\_1. The assembly code is as follows:

```
00FD1000 MOV EAX,DWORD PTR SS:[ARG.1]
00FD1004 MOV ECX,DWORD PTR SS:[ARG.2]
00FD1008 MOV EAX,DWORD PTR DS:[EAX]
00FD100A MOV ECX,DWORD PTR DS:[ECX]
00FD100C CMP EAX,ECX
00FD100E JNE SHORT 00FD1013
00FD1010 XOR EAX,EAX
00FD1012 RETN
00FD1013 XOR EDX,EDX
00FD1015 CMP EAX,ECX
00FD1017 SETGE DL
00FD101A LEA EAX,[EDX+EDX-1]
00FD101E RETN
00FD101F INT3
00FD1020 SUB ESP,2C
00FD1022 MOV EAX,DWORD PTR DS:[0FD3010]
```

The registers window shows the following values:

Register	Value
EAX	00000764
ECX	00000005
EDX	00000000
EBX	0037FECC
ESP	0037FD80
EBP	0037FE98
ESI	0037FEDC
EDI	0037FEB8
EIP	00FD100C 17_1.00FD100C

The hex dump window shows the memory contents at 00FD3000:

Address	Hex dump	ASCII (ANSI)
00FD3000	4E 75 6D 62 65 72 20 3D 20 25 64 0A 00 00 00 00	Number = %d
00FD3010	48 CE DF DE B7 31 20 21 FF FF FF FF FF FF FF FF	Hi i ?
00FD3020	FE FF FF FF 01 00 00 00 01 00 00 00 48 28 18 00	hNt
00FD3030	68 4E 18 00 00 00 00 00 00 00 00 00 00 00 00 00	
00FD3040	00 00 00 00 00 00 00 00 00 00 00 00 00 00 00 00	
00FD3050	00 00 00 00 00 00 00 00 00 00 00 00 00 00 00 00	
00FD3060	00 00 00 00 00 00 00 00 00 00 00 00 00 00 00 00	
00FD3070	00 00 00 00 00 00 00 00 00 00 00 00 00 00 00 00	
00FD3080	00 00 00 00 00 00 00 00 00 00 00 00 00 00 00 00	

Figure 1.110: OllyDbg: first call of `comp()`

OllyDbg shows the compared values in the window under the code window, for convenience. We can also see that the `SP` points to `RA`, where the `qsort()` function is (located in `MSVC100.DLL`).

By tracing (F8) until the RETN instruction and pressing F8 one more time, we return to the qsort () function:

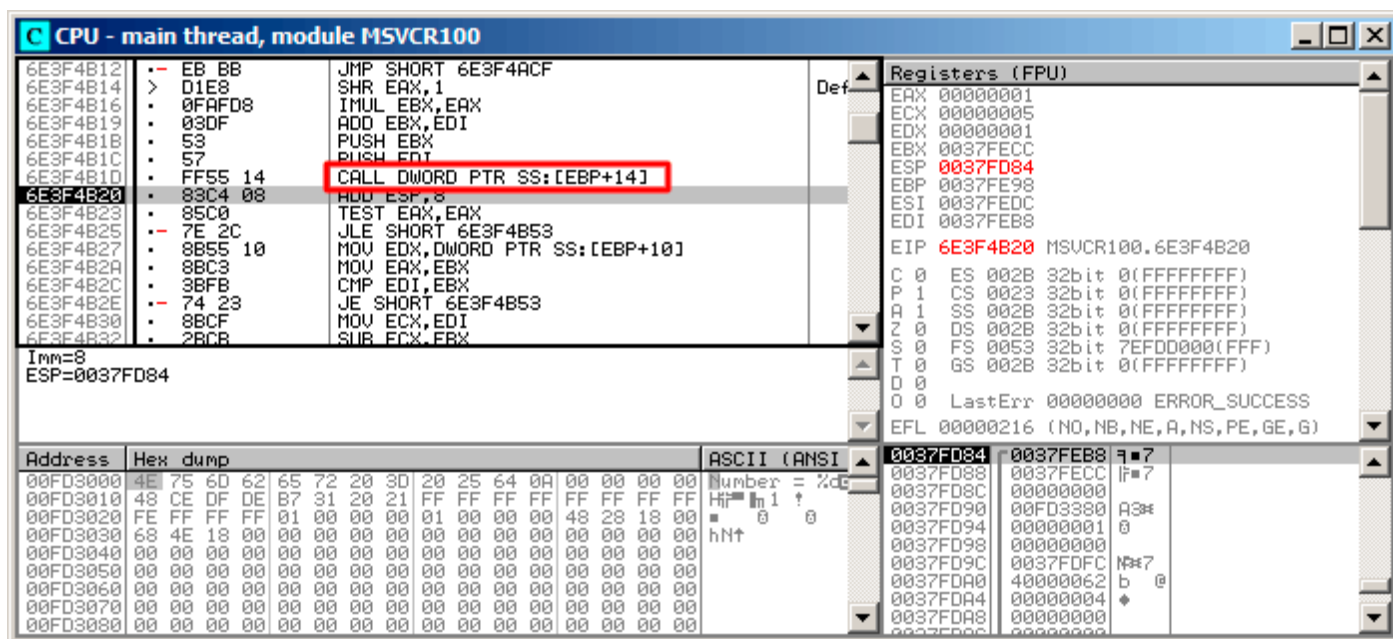

Figure 1.111: OllyDbg: the code in qsort () right after comp () call

That has been a call to the comparison function.

Here is also a screenshot of the moment of the second call of `comp()`—now values that have to be compared are different:

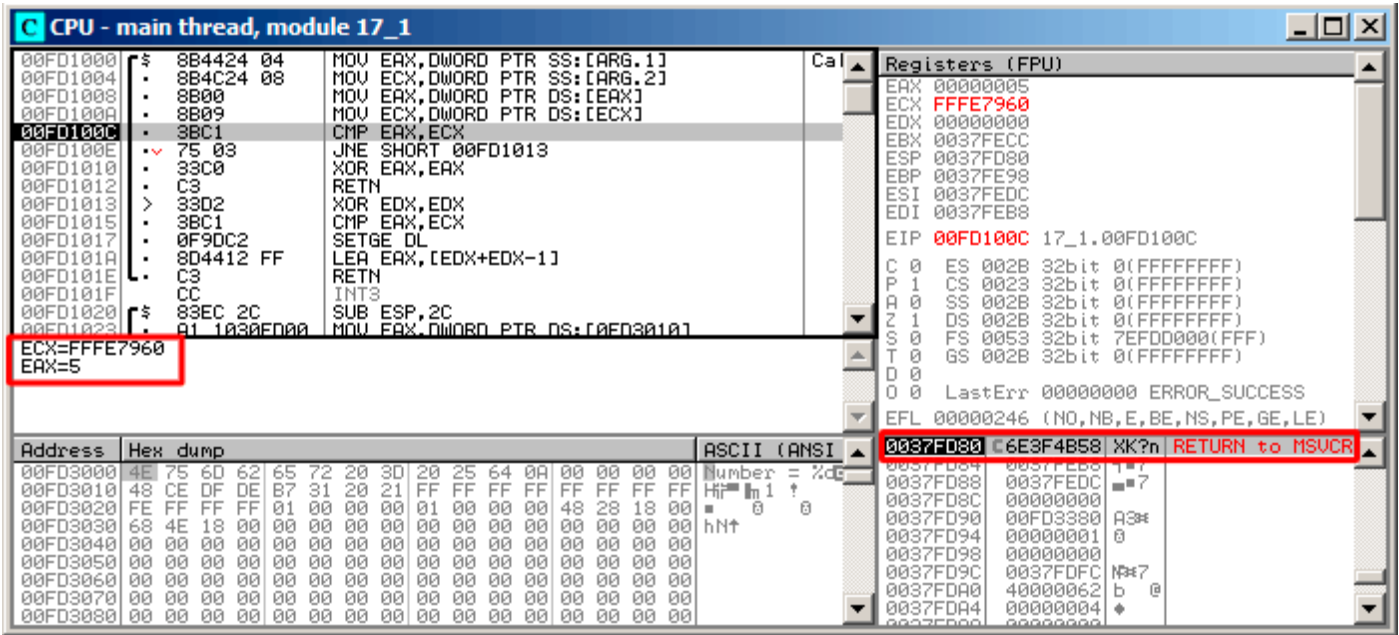

Figure 1.112: OllyDbg: second call of `comp()`

### MSVC + tracer

Let's also see which pairs are compared. These 10 numbers are being sorted: 1892, 45, 200, -98, 4087, 5, -12345, 1087, 88, -100000.

We got the address of the first `CMP` instruction in `comp()`, it is `0x0040100C` and we've set a breakpoint on it:

```
tracer.exe -l:17_1.exe bpx=17_1.exe!0x0040100C
```

Now we get some information about the registers at the breakpoint:

```
PID=4336|New process 17_1.exe
(0) 17_1.exe!0x40100c
EAX=0x00000764 EBX=0x0051f7c8 ECX=0x00000005 EDX=0x00000000
ESI=0x0051f7d8 EDI=0x0051f7b4 EBP=0x0051f794 ESP=0x0051f67c
EIP=0x0028100c
FLAGS=IF
(0) 17_1.exe!0x40100c
EAX=0x00000005 EBX=0x0051f7c8 ECX=0xffffe7960 EDX=0x00000000
ESI=0x0051f7d8 EDI=0x0051f7b4 EBP=0x0051f794 ESP=0x0051f67c
EIP=0x0028100c
FLAGS=PF ZF IF
(0) 17_1.exe!0x40100c
EAX=0x00000764 EBX=0x0051f7c8 ECX=0x00000005 EDX=0x00000000
ESI=0x0051f7d8 EDI=0x0051f7b4 EBP=0x0051f794 ESP=0x0051f67c
EIP=0x0028100c
FLAGS=CF PF ZF IF
...
```

Let's filter out `EAX` and `ECX` and we got:

```
EAX=0x00000764 ECX=0x00000005
EAX=0x00000005 ECX=0xffffe7960
EAX=0x00000764 ECX=0x00000005
EAX=0x0000002d ECX=0x00000005
```

EAX=0x00000058	ECX=0x00000005
EAX=0x0000043f	ECX=0x00000005
EAX=0xffffcfc7	ECX=0x00000005
EAX=0x000000c8	ECX=0x00000005
EAX=0xffffffff9e	ECX=0x00000005
EAX=0x00000ff7	ECX=0x00000005
EAX=0x00000ff7	ECX=0x00000005
EAX=0xffffffff9e	ECX=0x00000005
EAX=0xffffffff9e	ECX=0x00000005
EAX=0xffffcfc7	ECX=0xfffe7960
EAX=0x00000005	ECX=0xffffcfc7
EAX=0xffffffff9e	ECX=0x00000005
EAX=0xffffcfc7	ECX=0xfffe7960
EAX=0xffffffff9e	ECX=0xffffcfc7
EAX=0xffffcfc7	ECX=0xfffe7960
EAX=0x000000c8	ECX=0x00000ff7
EAX=0x0000002d	ECX=0x00000ff7
EAX=0x0000043f	ECX=0x00000ff7
EAX=0x00000058	ECX=0x00000ff7
EAX=0x00000764	ECX=0x00000ff7
EAX=0x000000c8	ECX=0x00000764
EAX=0x0000002d	ECX=0x00000764
EAX=0x0000043f	ECX=0x00000764
EAX=0x00000058	ECX=0x00000764
EAX=0x000000c8	ECX=0x00000058
EAX=0x0000002d	ECX=0x000000c8
EAX=0x0000043f	ECX=0x000000c8
EAX=0x000000c8	ECX=0x00000058
EAX=0x0000002d	ECX=0x000000c8
EAX=0x0000002d	ECX=0x00000058

That's 34 pairs. Therefore, the quick sort algorithm needs 34 comparison operations to sort these 10 numbers.



## MSVC + tracer (code coverage)

We can also use the tracer's feature to collect all possible register values and show them in [IDA](#).

Let's trace all instructions in `comp()`:

```
tracer.exe -l:17_1.exe bpf=17_1.exe!0x00401000,trace:cc
```

We get an `.idc-script` for loading into [IDA](#) and load it:

```
.text:00401000
.text:00401000 ; int __cdecl PtFuncCompare(const void *, const void *)
.text:00401000 PtFuncCompare proc near ; DATA XREF: _main+5Jo
.text:00401000
.text:00401000 arg_0 = dword ptr 4
.text:00401000 arg_4 = dword ptr 8
.text:00401000
.text:00401000 mov eax, [esp+arg_0] ; [ESP+4]=0x45f7ec..0x45f810(step=4), L"?\x04?
.text:00401004 mov ecx, [esp+arg_4] ; [ESP+8]=0x45f7ec..0x45f7f4(step=4), 0x45f7fc
.text:00401008 mov eax, [eax] ; [EAX]=5, 0x2d, 0x58, 0xc8, 0x43f, 0x764, 0xff
.text:0040100a mov ecx, [ecx] ; [ECX]=5, 0x58, 0xc8, 0x764, 0xff7, 0xfffe7960
.text:0040100c cmp eax, ecx ; EAX=5, 0x2d, 0x58, 0xc8, 0x43f, 0x764, 0xff7,
.text:0040100e jnz short loc_401013 ; ZF=false
.text:00401010 xor eax, eax
.text:00401012 retn
.text:00401013 ; -----
.text:00401013
.text:00401013 loc_401013: ; CODE XREF: PtFuncCompare+E1j
.text:00401013 xor edx, edx
.text:00401015 cmp eax, ecx ; EAX=5, 0x2d, 0x58, 0xc8, 0x43f, 0x764, 0xff7,
.text:00401017 setnl dl ; SF=false,true OF=false
.text:0040101a lea eax, [edx+edx-1]
.text:0040101e retn ; EAX=1, 0xffffffff
.text:0040101e PtFuncCompare endp
.text:0040101f
```

Figure 1.113: tracer and IDA. N.B.: some values are cut at right

[IDA](#) gave the function a name (`PtFuncCompare`)—because [IDA](#) sees that the pointer to this function is passed to `qsort()`.

We see that the *a* and *b* pointers are pointing to various places in the array, but the step between them is 4, as 32-bit values are stored in the array.

We see that the instructions at `0x401010` and `0x401012` were never executed (so they left as white): indeed, `comp()` has never returned 0, because there no equal elements in the array.

### 1.33.2 GCC

Not a big difference:

Listing 1.368: GCC

```
lea    eax, [esp+40h+var_28]
mov    [esp+40h+var_40], eax
mov    [esp+40h+var_28], 764h
mov    [esp+40h+var_24], 2Dh
mov    [esp+40h+var_20], 0C8h
mov    [esp+40h+var_1C], 0FFFFFF9Eh
mov    [esp+40h+var_18], 0FF7h
mov    [esp+40h+var_14], 5
mov    [esp+40h+var_10], 0FFFCFC7h
mov    [esp+40h+var_C], 43Fh
mov    [esp+40h+var_8], 58h
mov    [esp+40h+var_4], 0FFFE7960h
mov    [esp+40h+var_34], offset comp
mov    [esp+40h+var_38], 4
```

```

mov    [esp+40h+var_3C], 0Ah
call   _qsort

```

comp() function:

```

public comp
proc near
comp
arg_0    = dword ptr 8
arg_4    = dword ptr 0Ch

        push    ebp
        mov     ebp, esp
        mov     eax, [ebp+arg_4]
        mov     ecx, [ebp+arg_0]
        mov     edx, [eax]
        xor     eax, eax
        cmp     [ecx], edx
        jnz    short loc_8048458
        pop     ebp
        retn

loc_8048458:
        setnl   al
        movzx  eax, al
        lea   eax, [eax+eax-1]
        pop   ebp
        retn
comp
endp

```

The implementation of `qsort()` is located in `libc.so.6` and it is in fact just a wrapper <sup>162</sup> for `qsort_r()`. In turn, it is calling `quicksort()`, where our defined function is called via a passed pointer:

Listing 1.369: (file `libc.so.6`, `glibc` version—2.10.1)

```

...
.text:0002DDF6      mov     edx, [ebp+arg_10]
.text:0002DDF9      mov     [esp+4], esi
.text:0002DDFD      mov     [esp], edi
.text:0002DE00      mov     [esp+8], edx
.text:0002DE04      call   [ebp+arg_C]
...

```

## GCC + GDB (with source code)

Obviously, we have the C-source code of our example ( [1.33 on page 384](#)), so we can set a breakpoint (*b*) on line number (11—the line where the first comparison occurs). We also have to compile the example with debugging information included (`-g`), so the table with addresses and corresponding line numbers is present.

We can also print values using variable names (*p*): the debugging information also has tells us which register and/or local stack element contains which variable.

We can also see the stack (*bt*) and find out that there is some intermediate function `msort_with_tmp()` used in `Glibc`.

Listing 1.370: GDB session

```

dennis@ubuntuv:~/polygon$ gcc 17_1.c -g
dennis@ubuntuv:~/polygon$ gdb ./a.out
GNU gdb (GDB) 7.6.1-ubuntu
Copyright (C) 2013 Free Software Foundation, Inc.
...
Reading symbols from /home/dennis/polygon/a.out...done.
(gdb) b 17_1.c:11

```

<sup>162</sup>a concept like [thunk function](#)

```

Breakpoint 1 at 0x804845f: file 17_1.c, line 11.
(gdb) run
Starting program: /home/dennis/polygon/./a.out

Breakpoint 1, comp (_a=0xbffff0f8, _b=_b@entry=0xbffff0fc) at 17_1.c:11
11      if (*a==*b)
(gdb) p *a
$1 = 1892
(gdb) p *b
$2 = 45
(gdb) c
Continuing.

Breakpoint 1, comp (_a=0xbffff104, _b=_b@entry=0xbffff108) at 17_1.c:11
11      if (*a==*b)
(gdb) p *a
$3 = -98
(gdb) p *b
$4 = 4087
(gdb) bt
#0  comp (_a=0xbffff0f8, _b=_b@entry=0xbffff0fc) at 17_1.c:11
#1  0xb7e42872 in msort_with_tmp (p=p@entry=0xbffff07c, b=b@entry=0xbffff0f8, n=n@entry=2)
    at msort.c:65
#2  0xb7e4273e in msort_with_tmp (n=2, b=0xbffff0f8, p=0xbffff07c) at msort.c:45
#3  msort_with_tmp (p=p@entry=0xbffff07c, b=b@entry=0xbffff0f8, n=n@entry=5) at msort.c:53
#4  0xb7e4273e in msort_with_tmp (n=5, b=0xbffff0f8, p=0xbffff07c) at msort.c:45
#5  msort_with_tmp (p=p@entry=0xbffff07c, b=b@entry=0xbffff0f8, n=n@entry=10) at msort.c:53
#6  0xb7e42cef in msort_with_tmp (n=10, b=0xbffff0f8, p=0xbffff07c) at msort.c:45
#7  __GI_qsorth_r (b=b@entry=0xbffff0f8, n=n@entry=10, s=s@entry=4, cmp=cmp@entry=0x804844d <↵
    ↵ comp>,
    arg=arg@entry=0x0) at msort.c:297
#8  0xb7e42dcf in __GI_qsorth (b=0xbffff0f8, n=10, s=4, cmp=0x804844d <comp>) at msort.c:307
#9  0x0804850d in main (argc=1, argv=0xbffff1c4) at 17_1.c:26
(gdb)

```

## GCC + GDB (no source code)

But often there is no source code at all, so we can disassemble the `comp()` function (`disas`), find the very first `CMP` instruction and set a breakpoint (`b`) at that address.

At each breakpoint, we are going to dump all register contents (`info registers`). The stack information is also available (`bt`),

but partially: there is no line number information for `comp()`.

Listing 1.371: GDB session

```

dennis@ubuntuv:~/polygon$ gcc 17_1.c
dennis@ubuntuv:~/polygon$ gdb ./a.out
GNU gdb (GDB) 7.6.1-ubuntu
Copyright (C) 2013 Free Software Foundation, Inc.
...
Reading symbols from /home/dennis/polygon/a.out...(no debugging symbols found)...done.
(gdb) set disassembly-flavor intel
(gdb) disas comp
Dump of assembler code for function comp:
   0x0804844d <+0>:   push   ebp
   0x0804844e <+1>:   mov    ebp,esp
   0x08048450 <+3>:   sub    esp,0x10
   0x08048453 <+6>:   mov    eax,DWORD PTR [ebp+0x8]
   0x08048456 <+9>:   mov    DWORD PTR [ebp-0x8],eax
   0x08048459 <+12>:  mov    eax,DWORD PTR [ebp+0xc]
   0x0804845c <+15>:  mov    DWORD PTR [ebp-0x4],eax
   0x0804845f <+18>:  mov    eax,DWORD PTR [ebp-0x8]
   0x08048462 <+21>:  mov    edx,DWORD PTR [eax]
   0x08048464 <+23>:  mov    eax,DWORD PTR [ebp-0x4]
   0x08048467 <+26>:  mov    eax,DWORD PTR [eax]
   0x08048469 <+28>:  cmp    edx,eax
   0x0804846b <+30>:  jne   0x8048474 <comp+39>
   0x0804846d <+32>:  mov    eax,0x0

```

```

0x08048472 <+37>: jmp 0x804848e <comp+65>
0x08048474 <+39>: mov eax,DWORD PTR [ebp-0x8]
0x08048477 <+42>: mov edx,DWORD PTR [eax]
0x08048479 <+44>: mov eax,DWORD PTR [ebp-0x4]
0x0804847c <+47>: mov eax,DWORD PTR [eax]
0x0804847e <+49>: cmp edx,eax
0x08048480 <+51>: jge 0x8048489 <comp+60>
0x08048482 <+53>: mov eax,0xffffffff
0x08048487 <+58>: jmp 0x804848e <comp+65>
0x08048489 <+60>: mov eax,0x1
0x0804848e <+65>: leave
0x0804848f <+66>: ret

```

End of assembler dump.

(gdb) b \*0x08048469

Breakpoint 1 at 0x8048469

(gdb) run

Starting program: /home/dennis/polygon/./a.out

Breakpoint 1, 0x08048469 in comp ()

(gdb) info registers

```

eax          0x2d      45
ecx          0xbffff0f8   -1073745672
edx          0x764     1892
ebx          0xb7fc0000   -1208221696
esp          0xbfffeeb8   0xbfffeeb8
ebp          0xbfffeec8   0xbfffeec8
esi          0xbffff0fc   -1073745668
edi          0xbffff010   -1073745904
eip          0x8048469   0x8048469 <comp+28>
eflags      0x286     [ PF SF IF ]
cs          0x73     115
ss          0x7b     123
ds          0x7b     123
es          0x7b     123
fs          0x0      0
gs          0x33     51

```

(gdb) c

Continuing.

Breakpoint 1, 0x08048469 in comp ()

(gdb) info registers

```

eax          0xff7     4087
ecx          0xbffff104   -1073745660
edx          0xffffffff9e   -98
ebx          0xb7fc0000   -1208221696
esp          0xbfffee58   0xbfffee58
ebp          0xbfffee68   0xbfffee68
esi          0xbffff108   -1073745656
edi          0xbffff010   -1073745904
eip          0x8048469   0x8048469 <comp+28>
eflags      0x282     [ SF IF ]
cs          0x73     115
ss          0x7b     123
ds          0x7b     123
es          0x7b     123
fs          0x0      0
gs          0x33     51

```

(gdb) c

Continuing.

Breakpoint 1, 0x08048469 in comp ()

(gdb) info registers

```

eax          0xffffffff9e   -98
ecx          0xbffff100   -1073745664
edx          0xc8      200
ebx          0xb7fc0000   -1208221696
esp          0xbfffeeb8   0xbfffeeb8
ebp          0xbfffeec8   0xbfffeec8
esi          0xbffff104   -1073745660
edi          0xbffff010   -1073745904

```

```

eip          0x8048469      0x8048469 <comp+28>
eflags      0x286      [ PF SF IF ]
cs          0x73      115
ss          0x7b      123
ds          0x7b      123
es          0x7b      123
fs          0x0       0
gs          0x33      51
(gdb) bt
#0  0x08048469 in comp ()
#1  0xb7e42872 in msort_with_tmp (p=p@entry=0xbffff07c, b=b@entry=0xbffff0f8, n=n@entry=2)
    at msort.c:65
#2  0xb7e4273e in msort_with_tmp (n=2, b=0xbffff0f8, p=0xbffff07c) at msort.c:45
#3  msort_with_tmp (p=p@entry=0xbffff07c, b=b@entry=0xbffff0f8, n=n@entry=5) at msort.c:53
#4  0xb7e4273e in msort_with_tmp (n=5, b=0xbffff0f8, p=0xbffff07c) at msort.c:45
#5  msort_with_tmp (p=p@entry=0xbffff07c, b=b@entry=0xbffff0f8, n=n@entry=10) at msort.c:53
#6  0xb7e42cef in msort_with_tmp (n=10, b=0xbffff0f8, p=0xbffff07c) at msort.c:45
#7  __GI_qsorth_r (b=b@entry=0xbffff0f8, n=n@entry=10, s=s@entry=4, cmp=cmp@entry=0x804844d <
    ↪ comp>,
    arg=arg@entry=0x0) at msort.c:297
#8  0xb7e42dcf in __GI_qsorth (b=0xbffff0f8, n=10, s=4, cmp=0x804844d <comp>) at msort.c:307
#9  0x0804850d in main ()

```

### 1.33.3 Danger of pointers to functions

As we can see, `qsorth()` function expects a pointer to function which takes two *void\** arguments and returning integer. If you have several comparison functions in your code (one compares string, another—integers, etc), it's very easy to mix them up with each other. You could try to sort array of string using function which compares integers, and compiler will not warn you about bug.

## 1.34 64-bit values in 32-bit environment

In a 32-bit environment, [GPR's](#) are 32-bit, so 64-bit values are stored and passed as 32-bit value pairs <sup>163</sup>.

### 1.34.1 Returning of 64-bit value

```

#include <stdint.h>

uint64_t f ()
{
    return 0x1234567890ABCDEF;
};

```

#### x86

In a 32-bit environment, 64-bit values are returned from functions in the EDX:EAX register pair.

Listing 1.372: Optimizing MSVC 2010

```

_f      PROC
        mov     eax, -1867788817 ; 90abcdefH
        mov     edx, 305419896   ; 12345678H
        ret     0
_f      ENDP

```

#### ARM

A 64-bit value is returned in the R0-R1 register pair (R1 is for the high part and R0 for the low part):

Listing 1.373: Optimizing Keil 6/2013 (ARM mode)

```

||f|| PROC
        LDR     r0, |L0.12|

```

<sup>163</sup>By the way, 32-bit values are passed as pairs in 16-bit environment in the same way: [3.34.4 on page 652](#)

```

    LDR    r1, |L0.16|
    BX    lr
    ENDP

|L0.12|
    DCD    0x90abcdef
|L0.16|
    DCD    0x12345678

```

## MIPS

A 64-bit value is returned in the V0-V1 (\$2-\$3) register pair (V0 (\$2) is for the high part and V1 (\$3) for the low part):

Listing 1.374: Optimizing GCC 4.4.5 (assembly listing)

```

li    $3, -1867841536    # 0xffffffff90ab0000
li    $2, 305397760      # 0x12340000
ori   $3, $3, 0xcdef
j     $31
ori   $2, $2, 0x5678

```

Listing 1.375: Optimizing GCC 4.4.5 (IDA)

```

lui   $v1, 0x90AB
lui   $v0, 0x1234
li    $v1, 0x90ABCDEF
jr    $ra
li    $v0, 0x12345678

```

### 1.34.2 Arguments passing, addition, subtraction

```

#include <stdint.h>

uint64_t f_add (uint64_t a, uint64_t b)
{
    return a+b;
};

void f_add_test ()
{
#ifdef __GNUC__
    printf ("%lld\n", f_add(12345678901234, 2345678901234));
#else
    printf ("%I64d\n", f_add(12345678901234, 2345678901234));
#endif
};

uint64_t f_sub (uint64_t a, uint64_t b)
{
    return a-b;
};

```

## x86

Listing 1.376: Optimizing MSVC 2012 /Ob1

```

_a$ = 8        ; size = 8
_b$ = 16       ; size = 8
_f_add PROC
    mov     eax, DWORD PTR _a$[esp-4]
    add     eax, DWORD PTR _b$[esp-4]
    mov     edx, DWORD PTR _a$[esp]
    adc     edx, DWORD PTR _b$[esp]
    ret     0
_f_add ENDP

```

```

_f_add_test PROC
    push    5461                ; 00001555H
    push    1972608889         ; 75939f79H
    push    2874                ; 00000b3aH
    push    1942892530         ; 73ce2ff2H
    call    _f_add
    push    edx
    push    eax
    push    OFFSET $SG1436 ; '%I64d', 0aH, 00H
    call    _printf
    add     esp, 28
    ret     0
_f_add_test ENDP

_f_sub PROC
    mov     eax, DWORD PTR _a$[esp-4]
    sub     eax, DWORD PTR _b$[esp-4]
    mov     edx, DWORD PTR _a$[esp]
    sbb    edx, DWORD PTR _b$[esp]
    ret     0
_f_sub ENDP

```

We can see in the `f_add_test()` function that each 64-bit value is passed using two 32-bit values, high part first, then low part.

Addition and subtraction occur in pairs as well.

In addition, the low 32-bit part are added first. If carry has been occurred while adding, the CF flag is set.

The following ADC instruction adds the high parts of the values, and also adds 1 if  $CF = 1$ .

Subtraction also occurs in pairs. The first SUB may also turn on the CF flag, which is to be checked in the subsequent SBB instruction: if the carry flag is on, then 1 is also to be subtracted from the result.

It is easy to see how the `f_add()` function result is then passed to `printf()`.

Listing 1.377: GCC 4.8.1 -O1 -fno-inline

```

_f_add:
    mov     eax, DWORD PTR [esp+12]
    mov     edx, DWORD PTR [esp+16]
    add     eax, DWORD PTR [esp+4]
    adc     edx, DWORD PTR [esp+8]
    ret

_f_add_test:
    sub     esp, 28
    mov     DWORD PTR [esp+8], 1972608889 ; 75939f79H
    mov     DWORD PTR [esp+12], 5461 ; 00001555H
    mov     DWORD PTR [esp], 1942892530 ; 73ce2ff2H
    mov     DWORD PTR [esp+4], 2874 ; 00000b3aH
    call    _f_add
    mov     DWORD PTR [esp+4], eax
    mov     DWORD PTR [esp+8], edx
    mov     DWORD PTR [esp], OFFSET FLAT:LC0 ; "%lld\n"
    call    _printf
    add     esp, 28
    ret

_f_sub:
    mov     eax, DWORD PTR [esp+4]
    mov     edx, DWORD PTR [esp+8]
    sub     eax, DWORD PTR [esp+12]
    sbb    edx, DWORD PTR [esp+16]
    ret

```

GCC code is the same.

## ARM

Listing 1.378: Optimizing Keil 6/2013 (ARM mode)

```

f_add PROC
    ADDS    r0,r0,r2
    ADC     r1,r1,r3
    BX     lr
    ENDP

f_sub PROC
    SUBS    r0,r0,r2
    SBC     r1,r1,r3
    BX     lr
    ENDP

f_add_test PROC
    PUSH    {r4,lr}
    LDR     r2,|L0.68| ; 0x75939f79
    LDR     r3,|L0.72| ; 0x00001555
    LDR     r0,|L0.76| ; 0x73ce2ff2
    LDR     r1,|L0.80| ; 0x00000b3a
    BL     f_add
    POP     {r4,lr}
    MOV     r2,r0
    MOV     r3,r1
    ADR     r0,|L0.84| ; "%I64d\n"
    B      __2printf
    ENDP

|L0.68|
    DCD     0x75939f79
|L0.72|
    DCD     0x00001555
|L0.76|
    DCD     0x73ce2ff2
|L0.80|
    DCD     0x00000b3a
|L0.84|
    DCB     "%I64d\n",0

```

The first 64-bit value is passed in R0 and R1 register pair, the second in R2 and R3 register pair. ARM has the ADC instruction as well (which counts carry flag) and SBC (“subtract with carry”). Important thing: when the low parts are added/subtracted, ADDS and SUBS instructions with -S suffix are used. The -S suffix stands for “set flags”, and flags (esp. carry flag) is what consequent ADC/SBC instructions definitely need. Otherwise, instructions without the -S suffix would do the job (ADD and SUB).

## MIPS

Listing 1.379: Optimizing GCC 4.4.5 (IDA)

```

f_add:
; $a0 - high part of a
; $a1 - low part of a
; $a2 - high part of b
; $a3 - low part of b
    addu    $v1, $a3, $a1 ; sum up low parts
    addu    $a0, $a2, $a0 ; sum up high parts
; will carry generated while summing up low parts?
; if yes, set $v0 to 1
    sltu    $v0, $v1, $a3
    jr      $ra
; add 1 to high part of result if carry should be generated:
    addu    $v0, $a0 ; branch delay slot
; $v0 - high part of result
; $v1 - low part of result

f_sub:
; $a0 - high part of a
; $a1 - low part of a
; $a2 - high part of b
; $a3 - low part of b

```



```

        subu    $v1, $a1, $a3 ; subtract low parts
        subu    $v0, $a0, $a2 ; subtract high parts
; will carry generated while subtracting low parts?
; if yes, set $a0 to 1
        sltu    $a1, $v1
        jr      $ra
; subtract 1 from high part of result if carry should be generated:
        subu    $v0, $a1 ; branch delay slot
; $v0 - high part of result
; $v1 - low part of result

f_add_test:

var_10      = -0x10
var_4       = -4

        lui    $gp, (__gnu_local_gp >> 16)
        addiu  $sp, -0x20
        la     $gp, (__gnu_local_gp & 0xFFFF)
        sw     $ra, 0x20+var_4($sp)
        sw     $gp, 0x20+var_10($sp)
        lui    $a1, 0x73CE
        lui    $a3, 0x7593
        li     $a0, 0xB3A
        li     $a3, 0x75939F79
        li     $a2, 0x1555
        jal    f_add
        li     $a1, 0x73CE2FF2
        lw     $gp, 0x20+var_10($sp)
        lui    $a0, ($LC0 >> 16) # "%lld\n"
        lw     $t9, (printf & 0xFFFF)($gp)
        lw     $ra, 0x20+var_4($sp)
        la     $a0, ($LC0 & 0xFFFF) # "%lld\n"
        move   $a3, $v1
        move   $a2, $v0
        jr     $t9
        addiu  $sp, 0x20

$LC0:    .ascii "%lld\n"<0>

```

MIPS has no flags register, so there is no such information present after the execution of arithmetic operations. So there are no instructions like x86's ADC and SBB. To know if the carry flag would be set, a comparison (using SLTU instruction) also occurs, which sets the destination register to 1 or 0. This 1 or 0 is then added or subtracted to/from the final result.

### 1.34.3 Multiplication, division

```

#include <stdint.h>

uint64_t f_mul (uint64_t a, uint64_t b)
{
    return a*b;
};

uint64_t f_div (uint64_t a, uint64_t b)
{
    return a/b;
};

uint64_t f_rem (uint64_t a, uint64_t b)
{
    return a % b;
};

```

**x86**

Listing 1.380: Optimizing MSVC 2013 /Ob1

```

_a$ = 8 ; size = 8
_b$ = 16 ; size = 8
_f_mul PROC
    push    ebp
    mov     ebp, esp
    mov     eax, DWORD PTR _b$[ebp+4]
    push    eax
    mov     ecx, DWORD PTR _b$[ebp]
    push    ecx
    mov     edx, DWORD PTR _a$[ebp+4]
    push    edx
    mov     eax, DWORD PTR _a$[ebp]
    push    eax
    call    __allmul ; long long multiplication
    pop     ebp
    ret     0
_f_mul ENDP

_a$ = 8 ; size = 8
_b$ = 16 ; size = 8
_f_div PROC
    push    ebp
    mov     ebp, esp
    mov     eax, DWORD PTR _b$[ebp+4]
    push    eax
    mov     ecx, DWORD PTR _b$[ebp]
    push    ecx
    mov     edx, DWORD PTR _a$[ebp+4]
    push    edx
    mov     eax, DWORD PTR _a$[ebp]
    push    eax
    call    __aulldiv ; unsigned long long division
    pop     ebp
    ret     0
_f_div ENDP

_a$ = 8 ; size = 8
_b$ = 16 ; size = 8
_f_rem PROC
    push    ebp
    mov     ebp, esp
    mov     eax, DWORD PTR _b$[ebp+4]
    push    eax
    mov     ecx, DWORD PTR _b$[ebp]
    push    ecx
    mov     edx, DWORD PTR _a$[ebp+4]
    push    edx
    mov     eax, DWORD PTR _a$[ebp]
    push    eax
    call    __aullrem ; unsigned long long remainder
    pop     ebp
    ret     0
_f_rem ENDP

```

Multiplication and division are more complex operations, so usually the compiler embeds calls to a library functions doing that.

These functions are described here: [.5 on page 1044](#).

Listing 1.381: Optimizing GCC 4.8.1 -fno-inline

```

_f_mul:
    push    ebx
    mov     edx, DWORD PTR [esp+8]
    mov     eax, DWORD PTR [esp+16]
    mov     ebx, DWORD PTR [esp+12]
    mov     ecx, DWORD PTR [esp+20]
    imul   ebx, eax
    imul   ecx, edx
    mul    edx
    add    ecx, ebx

```

```

    add    edx, ecx
    pop    ebx
    ret

_f_div:
    sub    esp, 28
    mov    eax, DWORD PTR [esp+40]
    mov    edx, DWORD PTR [esp+44]
    mov    DWORD PTR [esp+8], eax
    mov    eax, DWORD PTR [esp+32]
    mov    DWORD PTR [esp+12], edx
    mov    edx, DWORD PTR [esp+36]
    mov    DWORD PTR [esp], eax
    mov    DWORD PTR [esp+4], edx
    call   ___udivdi3 ; unsigned division
    add    esp, 28
    ret

_f_rem:
    sub    esp, 28
    mov    eax, DWORD PTR [esp+40]
    mov    edx, DWORD PTR [esp+44]
    mov    DWORD PTR [esp+8], eax
    mov    eax, DWORD PTR [esp+32]
    mov    DWORD PTR [esp+12], edx
    mov    edx, DWORD PTR [esp+36]
    mov    DWORD PTR [esp], eax
    mov    DWORD PTR [esp+4], edx
    call   ___umoddi3 ; unsigned modulo
    add    esp, 28
    ret

```

GCC does the expected, but the multiplication code is inlined right in the function, thinking it could be more efficient. GCC has different library function names: [.4 on page 1044](#).

## ARM

Keil for Thumb mode inserts library subroutine calls:

Listing 1.382: Optimizing Keil 6/2013 (Thumb mode)

```

||f_mul|| PROC
    PUSH    {r4,lr}
    BL      ___aeabi_lmul
    POP     {r4,pc}
    ENDP

||f_div|| PROC
    PUSH    {r4,lr}
    BL      ___aeabi_uldivmod
    POP     {r4,pc}
    ENDP

||f_rem|| PROC
    PUSH    {r4,lr}
    BL      ___aeabi_uldivmod
    MOVS   r0,r2
    MOVS   r1,r3
    POP     {r4,pc}
    ENDP

```

Keil for ARM mode, on the other hand, is able to produce 64-bit multiplication code:

Listing 1.383: Optimizing Keil 6/2013 (ARM mode)

```

||f_mul|| PROC
    PUSH    {r4,lr}
    UMULL   r12,r4,r0,r2
    MLA     r1,r2,r1,r4
    MLA     r1,r0,r3,r1

```

```

MOV    r0,r12
POP    {r4,pc}
ENDP

||f_div|| PROC
PUSH   {r4,lr}
BL     __aeabi_uldivmod
POP    {r4,pc}
ENDP

||f_rem|| PROC
PUSH   {r4,lr}
BL     __aeabi_uldivmod
MOV    r0,r2
MOV    r1,r3
POP    {r4,pc}
ENDP

```

## MIPS

Optimizing GCC for MIPS can generate 64-bit multiplication code, but has to call a library routine for 64-bit division:

Listing 1.384: Optimizing GCC 4.4.5 (IDA)

```

f_mul:
    mult    $a2, $a1
    mflo   $v0
    or     $at, $zero ; NOP
    or     $at, $zero ; NOP
    mult    $a0, $a3
    mflo   $a0
    addu   $v0, $a0
    or     $at, $zero ; NOP
    multu  $a3, $a1
    mfhi   $a2
    mflo   $v1
    jr     $ra
    addu   $v0, $a2

f_div:
var_10 = -0x10
var_4  = -4

    lui    $gp, (__gnu_local_gp >> 16)
    addiu  $sp, -0x20
    la     $gp, (__gnu_local_gp & 0xFFFF)
    sw     $ra, 0x20+var_4($sp)
    sw     $gp, 0x20+var_10($sp)
    lw     $t9, (__udivdi3 & 0xFFFF)($gp)
    or     $at, $zero
    jalr   $t9
    or     $at, $zero
    lw     $ra, 0x20+var_4($sp)
    or     $at, $zero
    jr     $ra
    addiu  $sp, 0x20

f_rem:
var_10 = -0x10
var_4  = -4

    lui    $gp, (__gnu_local_gp >> 16)
    addiu  $sp, -0x20
    la     $gp, (__gnu_local_gp & 0xFFFF)
    sw     $ra, 0x20+var_4($sp)
    sw     $gp, 0x20+var_10($sp)

```

```

lw      $t9, (__umoddi3 & 0xFFFF)($gp)
or      $at, $zero
jalr   $t9
or      $at, $zero
lw      $ra, 0x20+var_4($sp)
or      $at, $zero
jr      $ra
addiu   $sp, 0x20

```

There are a lot of **NOPs**, probably delay slots filled after the multiplication instruction (it's slower than other instructions, after all).

### 1.34.4 Shifting right

```

#include <stdint.h>

uint64_t f (uint64_t a)
{
    return a>>7;
};

```

## x86

Listing 1.385: Optimizing MSVC 2012 /Ob1

```

_a$ = 8      ; size = 8
_f          PROC
    mov     eax, DWORD PTR _a$[esp-4]
    mov     edx, DWORD PTR _a$[esp]
    shrd   eax, edx, 7
    shr    edx, 7
    ret    0
_f          ENDP

```

Listing 1.386: Optimizing GCC 4.8.1 -fno-inline

```

_f:
    mov     edx, DWORD PTR [esp+8]
    mov     eax, DWORD PTR [esp+4]
    shrd   eax, edx, 7
    shr    edx, 7
    ret

```

Shifting also occurs in two passes: first the lower part is shifted, then the higher part. But the lower part is shifted with the help of the SHRD instruction, it shifts the value of EAX by 7 bits, but pulls new bits from EDX, i.e., from the higher part. In other words, 64-bit value from EDX:EAX register's pair, as a whole, is shifted by 7 bits and lowest 32 bits of result are placed into EAX. The higher part is shifted using the much more popular SHR instruction: indeed, the freed bits in the higher part must be filled with zeros.

## ARM

ARM doesn't have such instruction as SHRD in x86, so the Keil compiler ought to do this using simple shifts and OR operations:

Listing 1.387: Optimizing Keil 6/2013 (ARM mode)

```

||f|| PROC
    LSR    r0, r0, #7
    ORR    r0, r0, r1, LSL #25
    LSR    r1, r1, #7
    BX     lr
    ENDP

```

Listing 1.388: Optimizing Keil 6/2013 (Thumb mode)

```

||f|| PROC
    LSLS   r2, r1, #25

```

```

LSRS    r0,r0,#7
ORRS    r0,r0,r2
LSRS    r1,r1,#7
BX      lr
ENDP

```

## MIPS

GCC for MIPS follows the same algorithm as Keil does for Thumb mode:

Listing 1.389: Optimizing GCC 4.4.5 (IDA)

```

f:
sll     $v0, $a0, 25
srl     $v1, $a1, 7
or      $v1, $v0, $v1
jr      $ra
srl     $v0, $a0, 7

```

### 1.34.5 Converting 32-bit value into 64-bit one

```

#include <stdint.h>

int64_t f (int32_t a)
{
    return a;
};

```

## x86

Listing 1.390: Optimizing MSVC 2012

```

_a$ = 8
_f    PROC
      mov     eax, DWORD PTR _a$[esp-4]
      cdq
      ret     0
_f    ENDP

```

Here we also run into necessity to extend a 32-bit signed value into a 64-bit signed one. Unsigned values are converted straightforwardly: all bits in the higher part must be set to 0. But this is not appropriate for signed data types: the sign has to be copied into the higher part of the resulting number.

The CDQ instruction does that here, it takes its input value in EAX, extends it to 64-bit and leaves it in the EDX:EAX register pair. In other words, CDQ gets the number sign from EAX (by getting the most significant bit in EAX), and depending of it, sets all 32 bits in EDX to 0 or 1. Its operation is somewhat similar to the MOVSS instruction.

## ARM

Listing 1.391: Optimizing Keil 6/2013 (ARM mode)

```

||f|| PROC
      ASR     r1,r0,#31
      BX      lr
      ENDP

```

Keil for ARM is different: it just arithmetically shifts right the input value by 31 bits. As we know, the sign bit is **MSB**, and the arithmetical shift copies the sign bit into the “emerged” bits. So after “ASR r1,r0,#31”, R1 containing 0xFFFFFFFF if the input value has been negative and 0 otherwise. R1 contains the high part of the resulting 64-bit value. In other words, this code just copies the **MSB** (sign bit) from the input value in R0 to all bits of the high 32-bit part of the resulting 64-bit value.

## MIPS

GCC for MIPS does the same as Keil did for ARM mode:

Listing 1.392: Optimizing GCC 4.4.5 (IDA)

```
f:
  sra    $v0, $a0, 31
  jr     $ra
  move   $v1, $a0
```

### 1.35 LARGE\_INTEGER structure case

Imagine this: late 1980s, you're Microsoft, and you're developing a new *serious OS* (Windows NT), that will compete with Unices. Target platform has both 32-bit and 64-bit CPUs. And you need a 64-bit integer datatype for all sort of purposes, starting at FILETIME<sup>164</sup> structure.

The problem: not all target C/C++ compilers support 64-bit integer yet (this is late 1980s). Surely, this will be changed in (near) future, but not now. What would you do?

While reading this, try to stop (and/or close this book) and think, how can you solve this problem.

---

<sup>164</sup><https://docs.microsoft.com/en-us/windows/desktop/api/minwinbase/ns-minwinbase-filetime>

This is what Microsoft did, something like this<sup>165</sup>:

```
union ULARGE_INTEGER
{
    struct backward_compatibility
    {
        DWORD LowPart;
        DWORD HighPart;
    };
#ifdef NEW_FANCY_COMPILER_SUPPORTING_64_BIT
    ULONGLONG QuadPart;
#endif
};
```

This is a chunk of 8 bytes, which can be accessed via 64-bit integer QuadPart (if compiled using newer compiler), or using two 32-bit integers (if compiled using old one).

QuadPart field is just absent here when compiled using old compiler.

Order is crucial: first field (LowPart) maps to lower 4 bytes of 64-bit value, second field (HighPart) maps to higher 4 bytes.

Microsoft also added utility functions for all the arithmetical operation, in a same manner as I already described: [1.34 on page 395](#).

And this is from the leaked Windows 2000 source code base:

Listing 1.393: i386 arch

```
;++
;
; LARGE_INTEGER
; RtlLargeIntegerAdd (
; IN LARGE_INTEGER Addend1,
; IN LARGE_INTEGER Addend2
; )
;
; Routine Description:
;
; This function adds a signed large integer to a signed large integer and
; returns the signed large integer result.
;
; Arguments:
;
; (TOS+4) = Addend1 - first addend value
; (TOS+12) = Addend2 - second addend value
;
; Return Value:
;
; The large integer result is stored in (edx:eax)
;
;--

cPublicProc _RtlLargeIntegerAdd ,4
cPublicFpo 4,0

    mov     eax,[esp]+4           ; (eax)=add1.low
    add     eax,[esp]+12         ; (eax)=sum.low
    mov     edx,[esp]+8         ; (edx)=add1.hi
    adc     edx,[esp]+16        ; (edx)=sum.hi
    stdRET     _RtlLargeIntegerAdd

stdENDP _RtlLargeIntegerAdd
```

<sup>165</sup>Not a copy-pasted source code, I wrote this



Listing 1.394: MIPS arch

```

LEAF_ENTRY(RtlLargeIntegerAdd)

lw      t0,4 * 4(sp)          // get low part of addend2 value
lw      t1,4 * 5(sp)          // get high part of addend2 value
addu    t0,t0,a2              // add low parts of large integer
addu    t1,t1,a3              // add high parts of large integer
sltu    t2,t0,a2              // generate carry from low part
addu    t1,t1,t2              // add carry to high part
sw      t0,0(a0)              // store low part of result
sw      t1,4(a0)              // store high part of result
move    v0,a0                 // set function return register
j       ra                    // return

.end    RtlLargeIntegerAdd

```

Now two 64-bit architectures:

Listing 1.395: Itanium arch

```

LEAF_ENTRY(RtlLargeIntegerAdd)

add     v0 = a0, a1           // add both quadword arguments
LEAF_RETURN

LEAF_EXIT(RtlLargeIntegerAdd)

```

Listing 1.396: DEC Alpha arch

```

LEAF_ENTRY(RtlLargeIntegerAdd)

addq    a0, a1, v0           // add both quadword arguments
ret     zero, (ra)           // return

.end    RtlLargeIntegerAdd

```

No need using 32-bit instructions on Itanium and DEC Alpha—64-bit ones are here already.

And this is what we can find in Windows Research Kernel:

```

DECLSPEC_DEPRECATED_DDK      // Use native __int64 math
__inline
LARGE_INTEGER
NTAPI
RtlLargeIntegerAdd (
    LARGE_INTEGER Addend1,
    LARGE_INTEGER Addend2
)
{
    LARGE_INTEGER Sum;

    Sum.QuadPart = Addend1.QuadPart + Addend2.QuadPart;
    return Sum;
}

```

All these functions can be dropped (in future), but now they just operate on QuadPart field. If this piece of code is to be compiled using a modern 32-bit compiler (that supports 64-bit integer), it will generate two 32-bit additions under the hood. From this moment, LowPart/HighPart fields can be dropped from the LARGE\_INTEGER union/structure.

Would you use such a technique today? Probably not, but if someone would need 128-bit integer data type, you can implement it just like this.

Also, needless to say, this works thanks to *little-endian* ( 2.8 on page 464) (all architectures Windows NT was developed for are *little-endian*). This trick wouldn't be possible on a *big-endian* architecture.

## 1.36 SIMD

**SIMD** is an acronym: *Single Instruction, Multiple Data*.

As its name implies, it processes multiple data using only one instruction.

Like the **FPU**, that **CPU** subsystem looks like a separate processor inside x86.

SIMD began as MMX in x86. 8 new 64-bit registers appeared: MM0-MM7.

Each MMX register can hold 2 32-bit values, 4 16-bit values or 8 bytes. For example, it is possible to add 8 8-bit values (bytes) simultaneously by adding two values in MMX registers.

One simple example is a graphics editor that represents an image as a two dimensional array. When the user changes the brightness of the image, the editor must add or subtract a coefficient to/from each pixel value. For the sake of brevity if we say that the image is grayscale and each pixel is defined by one 8-bit byte, then it is possible to change the brightness of 8 pixels simultaneously.

By the way, this is the reason why the *saturation* instructions are present in SIMD.

When the user changes the brightness in the graphics editor, overflow and underflow are not desirable, so there are addition instructions in SIMD which are not adding anything if the maximum value is reached, etc.

When MMX appeared, these registers were actually located in the FPU's registers. It was possible to use either FPU or MMX at the same time. One might think that Intel saved on transistors, but in fact the reason of such symbiosis was simpler —older **OS**s that are not aware of the additional CPU registers would not save them at the context switch, but saving the FPU registers. Thus, MMX-enabled CPU + old **OS** + process utilizing MMX features will still work.

SSE—is extension of the SIMD registers to 128 bits, now separate from the FPU.

AVX—another extension, to 256 bits.

Now about practical usage.

Of course, this is memory copy routines (memcpy), memory comparing (memcmp) and so on.

One more example: the DES encryption algorithm takes a 64-bit block and a 56-bit key, encrypt the block and produces a 64-bit result. The DES algorithm may be considered as a very large electronic circuit, with wires and AND/OR/NOT gates.

Bitslice DES<sup>166</sup> —is the idea of processing groups of blocks and keys simultaneously. Let's say, variable of type *unsigned int* on x86 can hold up to 32 bits, so it is possible to store there intermediate results for 32 block-key pairs simultaneously, using 64+56 variables of type *unsigned int*.

There is an utility to brute-force Oracle RDBMS passwords/hashes (ones based on DES), using slightly modified bitslice DES algorithm for SSE2 and AVX—now it is possible to encrypt 128 or 256 block-keys pairs simultaneously.

<http://go.yurichev.com/17313>

### 1.36.1 Vectorization

Vectorization<sup>167</sup> is when, for example, you have a loop taking couple of arrays for input and producing one array. The loop body takes values from the input arrays, does something and puts the result into the output array. Vectorization is to process several elements simultaneously.

Vectorization is not very fresh technology: the author of this textbook saw it at least on the Cray Y-MP supercomputer line from 1988 when he played with its "lite" version Cray Y-MP EL<sup>168</sup>.

For example:

```
for (i = 0; i < 1024; i++)
{
    C[i] = A[i]*B[i];
}
```

<sup>166</sup><http://go.yurichev.com/17329>

<sup>167</sup>Wikipedia: [vectorization](#)

<sup>168</sup>Remotely. It is installed in the museum of supercomputers: <http://go.yurichev.com/17081>

This fragment of code takes elements from A and B, multiplies them and saves the result into C.

If each array element we have is 32-bit *int*, then it is possible to load 4 elements from A into a 128-bit XMM-register, from B to another XMM-registers, and by executing *PMULLD* (*Multiply Packed Signed Dword Integers and Store Low Result*) and *PMULHW* (*Multiply Packed Signed Integers and Store High Result*), it is possible to get 4 64-bit [products](#) at once.

Thus, loop body execution count is  $1024/4$  instead of 1024, that is 4 times less and, of course, faster.

### Addition example

Some compilers can do vectorization automatically in simple cases, e.g., Intel C++<sup>169</sup>.

Here is tiny function:

```
int f (int sz, int *ar1, int *ar2, int *ar3)
{
    for (int i=0; i<sz; i++)
        ar3[i]=ar1[i]+ar2[i];

    return 0;
};
```

### Intel C++

Let's compile it with Intel C++ 11.1.051 win32:

```
icl intel.cpp /QaxSSE2 /Faintel.asm /Ox
```

We got (in [IDA](#)):

```
; int __cdecl f(int, int *, int *, int *)
                public ?f@YAHPAH00@Z
?f@YAHPAH00@Z proc near

var_10 = dword ptr -10h
sz      = dword ptr  4
ar1     = dword ptr  8
ar2     = dword ptr 0Ch
ar3     = dword ptr 10h

    push    edi
    push    esi
    push    ebx
    push    esi
    mov     edx, [esp+10h+sz]
    test   edx, edx
    jle    loc_15B
    mov     eax, [esp+10h+ar3]
    cmp    edx, 6
    jle    loc_143
    cmp    eax, [esp+10h+ar2]
    jbe    short loc_36
    mov     esi, [esp+10h+ar2]
    sub    esi, eax
    lea    ecx, ds:0[edx*4]
    neg    esi
    cmp    ecx, esi
    jbe    short loc_55

loc_36: ; CODE XREF: f(int,int *,int *,int *)+21
    cmp    eax, [esp+10h+ar2]
    jnb    loc_143
    mov     esi, [esp+10h+ar2]
    sub    esi, eax
    lea    ecx, ds:0[edx*4]
```

<sup>169</sup>More about Intel C++ automatic vectorization: [Excerpt: Effective Automatic Vectorization](#)

```

    cmp     esi, ecx
    jb     loc_143

loc_55: ; CODE XREF: f(int,int *,int *,int *)+34
    cmp     eax, [esp+10h+ar1]
    jbe    short loc_67
    mov     esi, [esp+10h+ar1]
    sub     esi, eax
    neg     esi
    cmp     ecx, esi
    jbe    short loc_7F

loc_67: ; CODE XREF: f(int,int *,int *,int *)+59
    cmp     eax, [esp+10h+ar1]
    jnb    loc_143
    mov     esi, [esp+10h+ar1]
    sub     esi, eax
    cmp     esi, ecx
    jb     loc_143

loc_7F: ; CODE XREF: f(int,int *,int *,int *)+65
    mov     edi, eax          ; edi = ar3
    and     edi, 0Fh         ; is ar3 16-byte aligned?
    jz     short loc_9A     ; yes
    test    edi, 3
    jnz    loc_162
    neg     edi
    add     edi, 10h
    shr     edi, 2

loc_9A: ; CODE XREF: f(int,int *,int *,int *)+84
    lea    ecx, [edi+4]
    cmp     edx, ecx
    jl     loc_162
    mov     ecx, edx
    sub     ecx, edi
    and     ecx, 3
    neg     ecx
    add     ecx, edx
    test    edi, edi
    jbe    short loc_D6
    mov     ebx, [esp+10h+ar2]
    mov     [esp+10h+var_10], ecx
    mov     ecx, [esp+10h+ar1]
    xor     esi, esi

loc_C1: ; CODE XREF: f(int,int *,int *,int *)+CD
    mov     edx, [ecx+esi*4]
    add     edx, [ebx+esi*4]
    mov     [eax+esi*4], edx
    inc     esi
    cmp     esi, edi
    jb     short loc_C1
    mov     ecx, [esp+10h+var_10]
    mov     edx, [esp+10h+sz]

loc_D6: ; CODE XREF: f(int,int *,int *,int *)+B2
    mov     esi, [esp+10h+ar2]
    lea    esi, [esi+edi*4] ; is ar2+i*4 16-byte aligned?
    test    esi, 0Fh
    jz     short loc_109    ; yes!
    mov     ebx, [esp+10h+ar1]
    mov     esi, [esp+10h+ar2]

loc_ED: ; CODE XREF: f(int,int *,int *,int *)+105
    movdqu xmm1, xmmword ptr [ebx+edi*4] ; ar1+i*4
    movdqu xmm0, xmmword ptr [esi+edi*4] ; ar2+i*4 is not 16-byte aligned, so load it to
XMM0
    paddq  xmm1, xmm0
    movdqa xmmword ptr [eax+edi*4], xmm1 ; ar3+i*4

```

```

    add     edi, 4
    cmp     edi, ecx
    jb     short loc_ED
    jmp     short loc_127

loc_109: ; CODE XREF: f(int,int *,int *,int *)+E3
    mov     ebx, [esp+10h+ar1]
    mov     esi, [esp+10h+ar2]

loc_111: ; CODE XREF: f(int,int *,int *,int *)+125
    movdqu xmm0, xmmword ptr [ebx+edi*4]
    paddd  xmm0, xmmword ptr [esi+edi*4]
    movdqa xmmword ptr [eax+edi*4], xmm0
    add     edi, 4
    cmp     edi, ecx
    jb     short loc_111

loc_127: ; CODE XREF: f(int,int *,int *,int *)+107
    ; f(int,int *,int *,int *)+164
    cmp     ecx, edx
    jnb    short loc_15B
    mov     esi, [esp+10h+ar1]
    mov     edi, [esp+10h+ar2]

loc_133: ; CODE XREF: f(int,int *,int *,int *)+13F
    mov     ebx, [esi+ecx*4]
    add     ebx, [edi+ecx*4]
    mov     [eax+ecx*4], ebx
    inc     ecx
    cmp     ecx, edx
    jb     short loc_133
    jmp     short loc_15B

loc_143: ; CODE XREF: f(int,int *,int *,int *)+17
    ; f(int,int *,int *,int *)+3A ...
    mov     esi, [esp+10h+ar1]
    mov     edi, [esp+10h+ar2]
    xor     ecx, ecx

loc_14D: ; CODE XREF: f(int,int *,int *,int *)+159
    mov     ebx, [esi+ecx*4]
    add     ebx, [edi+ecx*4]
    mov     [eax+ecx*4], ebx
    inc     ecx
    cmp     ecx, edx
    jb     short loc_14D

loc_15B: ; CODE XREF: f(int,int *,int *,int *)+A
    ; f(int,int *,int *,int *)+129 ...
    xor     eax, eax
    pop     ecx
    pop     ebx
    pop     esi
    pop     edi
    retn

loc_162: ; CODE XREF: f(int,int *,int *,int *)+8C
    ; f(int,int *,int *,int *)+9F
    xor     ecx, ecx
    jmp     short loc_127
?f@YAHHPAH00@Z endp

```

The SSE2-related instructions are:

- **MOVDQU** (*Move Unaligned Double Quadword*)—just loads 16 bytes from memory into a XMM-register.
- **PADD** (*Add Packed Integers*)—adds 4 pairs of 32-bit numbers and leaves the result in the first operand. By the way, no exception is raised in case of overflow and no flags are to be set, just the low 32 bits of the result are to be stored. If one of PADD's operands is the address of a value in memory, then the address must be aligned on a 16-byte boundary. If it is not aligned, an exception will be triggered.

- `MOVDQA` (*Move Aligned Double Quadword*) is the same as `MOVDQU`, but requires the address of the value in memory to be aligned on a 16-bit boundary. If it is not aligned, exception will be raised. `MOVDQA` works faster than `MOVDQU`, but requires aforesaid.

So, these SSE2-instructions are to be executed only in case there are more than 4 pairs to work on and the pointer `ar3` is aligned on a 16-byte boundary.

Also, if `ar2` is aligned on a 16-byte boundary as well, this fragment of code is to be executed:

```
movdqu xmm0, xmmword ptr [ebx+edi*4] ; ar1+i*4
padd   xmm0, xmmword ptr [esi+edi*4] ; ar2+i*4
movdqa xmmword ptr [eax+edi*4], xmm0 ; ar3+i*4
```

Otherwise, the value from `ar2` is to be loaded into `XMM0` using `MOVDQU`, which does not require aligned pointer, but may work slower:

```
movdqu xmm1, xmmword ptr [ebx+edi*4] ; ar1+i*4
movdqu xmm0, xmmword ptr [esi+edi*4] ; ar2+i*4 is not 16-byte aligned, so load it to XMM0
padd   xmm1, xmm0
movdqa xmmword ptr [eax+edi*4], xmm1 ; ar3+i*4
```

In all other cases, non-SSE2 code is to be executed.

## GCC

GCC may also vectorize in simple cases<sup>170</sup>, if the `-O3` option is used and SSE2 support is turned on: `-msse2`.

What we get (GCC 4.4.1):

```
; f(int, int *, int *, int *)
public _Z1fiPiS_S_
_Z1fiPiS_S_ proc near
var_18      = dword ptr -18h
var_14      = dword ptr -14h
var_10      = dword ptr -10h
arg_0       = dword ptr  8
arg_4       = dword ptr  0Ch
arg_8       = dword ptr  10h
arg_C       = dword ptr  14h

        push    ebp
        mov     ebp, esp
        push   edi
        push   esi
        push   ebx
        sub    esp, 0Ch
        mov     ecx, [ebp+arg_0]
        mov     esi, [ebp+arg_4]
        mov     edi, [ebp+arg_8]
        mov     ebx, [ebp+arg_C]
        test   ecx, ecx
        jle    short loc_80484D8
        cmp    ecx, 6
        lea   eax, [ebx+10h]
        ja     short loc_80484E8

loc_80484C1: ; CODE XREF: f(int,int *,int *,int *)+4B
             ; f(int,int *,int *,int *)+61 ...
        xor    eax, eax
        nop
        lea   esi, [esi+0]

loc_80484C8: ; CODE XREF: f(int,int *,int *,int *)+36
        mov     edx, [edi+eax*4]
        add    edx, [esi+eax*4]
```

<sup>170</sup>More about GCC vectorization support: <http://go.yurichev.com/17083>

```

        mov     [ebx+eax*4], edx
        add     eax, 1
        cmp     eax, ecx
        jnz     short loc_80484C8

loc_80484D8: ; CODE XREF: f(int,int *,int *,int *)+17
             ; f(int,int *,int *,int *)+A5
        add     esp, 0Ch
        xor     eax, eax
        pop     ebx
        pop     esi
        pop     edi
        pop     ebp
        retn

        align 8

loc_80484E8: ; CODE XREF: f(int,int *,int *,int *)+1F
        test    bl, 0Fh
        jnz     short loc_80484C1
        lea    edx, [esi+10h]
        cmp     ebx, edx
        jbe     loc_8048578

loc_80484F8: ; CODE XREF: f(int,int *,int *,int *)+E0
        lea    edx, [edi+10h]
        cmp     ebx, edx
        ja      short loc_8048503
        cmp     edi, eax
        jbe     short loc_80484C1

loc_8048503: ; CODE XREF: f(int,int *,int *,int *)+5D
        mov     eax, ecx
        shr     eax, 2
        mov     [ebp+var_14], eax
        shl     eax, 2
        test    eax, eax
        mov     [ebp+var_10], eax
        jz      short loc_8048547
        mov     [ebp+var_18], ecx
        mov     ecx, [ebp+var_14]
        xor     eax, eax
        xor     edx, edx
        nop

loc_8048520: ; CODE XREF: f(int,int *,int *,int *)+9B
        movdqu xmm1, xmmword ptr [edi+eax]
        movdqu xmm0, xmmword ptr [esi+eax]
        add     edx, 1
        padd    xmm0, xmm1
        movdqa  xmmword ptr [ebx+eax], xmm0
        add     eax, 10h
        cmp     edx, ecx
        jb      short loc_8048520
        mov     ecx, [ebp+var_18]
        mov     eax, [ebp+var_10]
        cmp     ecx, eax
        jz      short loc_80484D8

loc_8048547: ; CODE XREF: f(int,int *,int *,int *)+73
        lea    edx, ds:0[eax*4]
        add     esi, edx
        add     edi, edx
        add     ebx, edx
        lea    esi, [esi+0]

loc_8048558: ; CODE XREF: f(int,int *,int *,int *)+CC
        mov     edx, [edi]
        add     eax, 1
        add     edi, 4

```

```

    add     edx, [esi]
    add     esi, 4
    mov     [ebx], edx
    add     ebx, 4
    cmp     ecx, eax
    jg      short loc_8048558
    add     esp, 0Ch
    xor     eax, eax
    pop     ebx
    pop     esi
    pop     edi
    pop     ebp
    retn

```

```

loc_8048578: ; CODE XREF: f(int,int *,int *,int *)+52
    cmp     eax, esi
    jnb     loc_80484C1
    jmp     loc_80484F8
_Z1fiPiS_S_ endp

```

Almost the same, however, not as meticulously as Intel C++.

### Memory copy example

Let's revisit the simple memcpy() example ( [1.22.2 on page 195](#)):

```

#include <stdio.h>

void my_memcpy (unsigned char* dst, unsigned char* src, size_t cnt)
{
    size_t i;
    for (i=0; i<cnt; i++)
        dst[i]=src[i];
};

```

And that's what optimizations GCC 4.9.1 did:

Listing 1.397: Optimizing GCC 4.9.1 x64

```

my_memcpy:
; RDI = destination address
; RSI = source address
; RDX = size of block
    test    rdx, rdx
    je      .L41
    lea    rax, [rdi+16]
    cmp    rsi, rax
    lea    rax, [rsi+16]
    setae  cl
    cmp    rdi, rax
    setae  al
    or     cl, al
    je     .L13
    cmp    rdx, 22
    jbe    .L13
    mov    rcx, rsi
    push   rbp
    push   rbx
    neg    rcx
    and    ecx, 15
    cmp    rcx, rdx
    cmova  rcx, rdx
    xor    eax, eax
    test   rcx, rcx
    je     .L4
    movzx  eax, BYTE PTR [rsi]
    cmp    rcx, 1
    mov    BYTE PTR [rdi], al
    je     .L15
    movzx  eax, BYTE PTR [rsi+1]

```



```

cmp     rcx, 2
mov     BYTE PTR [rdi+1], al
je      .L16
movzx   eax, BYTE PTR [rsi+2]
cmp     rcx, 3
mov     BYTE PTR [rdi+2], al
je      .L17
movzx   eax, BYTE PTR [rsi+3]
cmp     rcx, 4
mov     BYTE PTR [rdi+3], al
je      .L18
movzx   eax, BYTE PTR [rsi+4]
cmp     rcx, 5
mov     BYTE PTR [rdi+4], al
je      .L19
movzx   eax, BYTE PTR [rsi+5]
cmp     rcx, 6
mov     BYTE PTR [rdi+5], al
je      .L20
movzx   eax, BYTE PTR [rsi+6]
cmp     rcx, 7
mov     BYTE PTR [rdi+6], al
je      .L21
movzx   eax, BYTE PTR [rsi+7]
cmp     rcx, 8
mov     BYTE PTR [rdi+7], al
je      .L22
movzx   eax, BYTE PTR [rsi+8]
cmp     rcx, 9
mov     BYTE PTR [rdi+8], al
je      .L23
movzx   eax, BYTE PTR [rsi+9]
cmp     rcx, 10
mov     BYTE PTR [rdi+9], al
je      .L24
movzx   eax, BYTE PTR [rsi+10]
cmp     rcx, 11
mov     BYTE PTR [rdi+10], al
je      .L25
movzx   eax, BYTE PTR [rsi+11]
cmp     rcx, 12
mov     BYTE PTR [rdi+11], al
je      .L26
movzx   eax, BYTE PTR [rsi+12]
cmp     rcx, 13
mov     BYTE PTR [rdi+12], al
je      .L27
movzx   eax, BYTE PTR [rsi+13]
cmp     rcx, 15
mov     BYTE PTR [rdi+13], al
jne     .L28
movzx   eax, BYTE PTR [rsi+14]
mov     BYTE PTR [rdi+14], al
mov     eax, 15

```

.L4:

```

mov     r10, rdx
lea     r9, [rdx-1]
sub     r10, rcx
lea     r8, [r10-16]
sub     r9, rcx
shr     r8, 4
add     r8, 1
mov     r11, r8
sal     r11, 4
cmp     r9, 14
jbe     .L6
lea     rbp, [rsi+rcx]
xor     r9d, r9d
add     rcx, rdi
xor     ebx, ebx

```

```

.L7:
movdqa  xmm0, XMMWORD PTR [rbp+0+r9]
add     rbx, 1
movups  XMMWORD PTR [rcx+r9], xmm0
add     r9, 16
cmp     rbx, r8
jb     .L7
add     rax, r11
cmp     r10, r11
je     .L1

```

```

.L6:
movzx   ecx, BYTE PTR [rsi+rax]
mov     BYTE PTR [rdi+rax], cl
lea     rcx, [rax+1]
cmp     rdx, rcx
jbe    .L1
movzx   ecx, BYTE PTR [rsi+1+rax]
mov     BYTE PTR [rdi+1+rax], cl
lea     rcx, [rax+2]
cmp     rdx, rcx
jbe    .L1
movzx   ecx, BYTE PTR [rsi+2+rax]
mov     BYTE PTR [rdi+2+rax], cl
lea     rcx, [rax+3]
cmp     rdx, rcx
jbe    .L1
movzx   ecx, BYTE PTR [rsi+3+rax]
mov     BYTE PTR [rdi+3+rax], cl
lea     rcx, [rax+4]
cmp     rdx, rcx
jbe    .L1
movzx   ecx, BYTE PTR [rsi+4+rax]
mov     BYTE PTR [rdi+4+rax], cl
lea     rcx, [rax+5]
cmp     rdx, rcx
jbe    .L1
movzx   ecx, BYTE PTR [rsi+5+rax]
mov     BYTE PTR [rdi+5+rax], cl
lea     rcx, [rax+6]
cmp     rdx, rcx
jbe    .L1
movzx   ecx, BYTE PTR [rsi+6+rax]
mov     BYTE PTR [rdi+6+rax], cl
lea     rcx, [rax+7]
cmp     rdx, rcx
jbe    .L1
movzx   ecx, BYTE PTR [rsi+7+rax]
mov     BYTE PTR [rdi+7+rax], cl
lea     rcx, [rax+8]
cmp     rdx, rcx
jbe    .L1
movzx   ecx, BYTE PTR [rsi+8+rax]
mov     BYTE PTR [rdi+8+rax], cl
lea     rcx, [rax+9]
cmp     rdx, rcx
jbe    .L1
movzx   ecx, BYTE PTR [rsi+9+rax]
mov     BYTE PTR [rdi+9+rax], cl
lea     rcx, [rax+10]
cmp     rdx, rcx
jbe    .L1
movzx   ecx, BYTE PTR [rsi+10+rax]
mov     BYTE PTR [rdi+10+rax], cl
lea     rcx, [rax+11]
cmp     rdx, rcx
jbe    .L1
movzx   ecx, BYTE PTR [rsi+11+rax]
mov     BYTE PTR [rdi+11+rax], cl
lea     rcx, [rax+12]
cmp     rdx, rcx

```

```

    jbe     .L1
    movzx  ecx, BYTE PTR [rsi+12+rax]
    mov    BYTE PTR [rdi+12+rax], cl
    lea   rcx, [rax+13]
    cmp   rdx, rcx
    jbe   .L1
    movzx  ecx, BYTE PTR [rsi+13+rax]
    mov    BYTE PTR [rdi+13+rax], cl
    lea   rcx, [rax+14]
    cmp   rdx, rcx
    jbe   .L1
    movzx  edx, BYTE PTR [rsi+14+rax]
    mov    BYTE PTR [rdi+14+rax], dl
.L1:
    pop    rbx
    pop    rbp
.L41:
    rep   ret
.L13:
    xor    eax, eax
.L3:
    movzx  ecx, BYTE PTR [rsi+rax]
    mov    BYTE PTR [rdi+rax], cl
    add    rax, 1
    cmp   rax, rdx
    jne   .L3
    rep   ret
.L28:
    mov    eax, 14
    jmp   .L4
.L15:
    mov    eax, 1
    jmp   .L4
.L16:
    mov    eax, 2
    jmp   .L4
.L17:
    mov    eax, 3
    jmp   .L4
.L18:
    mov    eax, 4
    jmp   .L4
.L19:
    mov    eax, 5
    jmp   .L4
.L20:
    mov    eax, 6
    jmp   .L4
.L21:
    mov    eax, 7
    jmp   .L4
.L22:
    mov    eax, 8
    jmp   .L4
.L23:
    mov    eax, 9
    jmp   .L4
.L24:
    mov    eax, 10
    jmp   .L4
.L25:
    mov    eax, 11
    jmp   .L4
.L26:
    mov    eax, 12
    jmp   .L4
.L27:
    mov    eax, 13
    jmp   .L4

```

## 1.36.2 SIMD strlen() implementation

It has to be noted that the SIMD instructions can be inserted in C/C++ code via special macros<sup>171</sup>. For MSVC, some of them are located in the `intrin.h` file.

It is possible to implement the `strlen()` function<sup>172</sup> using SIMD instructions that works 2-2.5 times faster than the common implementation. This function loads 16 characters into a XMM-register and check each against zero<sup>173</sup>.

```
size_t strlen_sse2(const char *str)
{
    register size_t len = 0;
    const char *s=str;
    bool str_is_aligned=(((unsigned int)str)&0xFFFFFFFF) == (unsigned int)str;

    if (str_is_aligned==false)
        return strlen (str);

    __m128i xmm0 = _mm_setzero_si128();
    __m128i xmm1;
    int mask = 0;

    for (;;)
    {
        xmm1 = _mm_load_si128((__m128i *)s);
        xmm1 = _mm_cmpeq_epi8(xmm1, xmm0);
        if ((mask = _mm_movemask_epi8(xmm1)) != 0)
        {
            unsigned long pos;
            _BitScanForward(&pos, mask);
            len += (size_t)pos;

            break;
        }
        s += sizeof(__m128i);
        len += sizeof(__m128i);
    };

    return len;
}
```

Let's compile it in MSVC 2010 with `/Ox` option:

Listing 1.398: Optimizing MSVC 2010

```
_pos$75552 = -4          ; size = 4
_str$ = 8              ; size = 4
?strlen_sse2@@YAIPBD@Z PROC ; strlen_sse2

    push    ebp
    mov     ebp, esp
    and     esp, -16          ; ffffffff0H
    mov     eax, DWORD PTR _str$[ebp]
    sub     esp, 12          ; 0000000cH
    push    esi
    mov     esi, eax
    and     esi, -16          ; ffffffff0H
    xor     edx, edx
    mov     ecx, eax
    cmp     esi, eax
    je     SHORT $LN4@strlen_sse
    lea    edx, DWORD PTR [eax+1]
    npad    3 ; align next label
$LL11@strlen_sse:
    mov     cl, BYTE PTR [eax]
    inc     eax
    test    cl, cl
```

<sup>171</sup>MSDN: MMX, SSE, and SSE2 Intrinsics

<sup>172</sup>`strlen()` —standard C library function for calculating string length

<sup>173</sup>The example is based on source code from: <http://go.yurichev.com/17330>.

```

jne     SHORT $LL11@strlen_sse
sub     eax, edx
pop     esi
mov     esp, ebp
pop     ebp
ret     0
$LN4@strlen_sse:
movdqa xmm1, XMMWORD PTR [eax]
pxor   xmm0, xmm0
pcmpeqb xmm1, xmm0
pmovmskb eax, xmm1
test   eax, eax
jne     SHORT $LN9@strlen_sse
$LL3@strlen_sse:
movdqa xmm1, XMMWORD PTR [ecx+16]
add    ecx, 16                ; 00000010H
pcmpeqb xmm1, xmm0
add    edx, 16                ; 00000010H
pmovmskb eax, xmm1
test   eax, eax
je     SHORT $LL3@strlen_sse
$LN9@strlen_sse:
bsf    eax, eax
mov    ecx, eax
mov    DWORD PTR _pos$75552[esp+16], eax
lea   eax, DWORD PTR [ecx+edx]
pop    esi
mov    esp, ebp
pop    ebp
ret    0
?strlen_sse2@@YAIPBD@Z ENDP                ; strlen_sse2

```

How it works? First of all, we must understand goal of the function. It calculates C-string length, but we can use different terms: it's task is searching for zero byte, and then calculating its position relatively to string start.

First, we check if the `str` pointer is aligned on a 16-byte boundary. If not, we call the generic `strlen()` implementation.

Then, we load the next 16 bytes into the XMM1 register using `MOVDQA`.

An observant reader might ask, why can't `MOVDQU` be used here since it can load data from the memory regardless pointer alignment?

Yes, it might be done in this way: if the pointer is aligned, load data using `MOVDQA`, if not —use the slower `MOVDQU`.

But here we are may hit another caveat:

In the [Windows NT](#) line of [OS](#) (but not limited to it), memory is allocated by pages of 4 KiB (4096 bytes). Each win32-process has 4 GiB available, but in fact, only some parts of the address space are connected to real physical memory. If the process is accessing an absent memory block, an exception is to be raised. That's how [VM](#) works<sup>174</sup>.

So, a function loading 16 bytes at once may step over the border of an allocated memory block. Let's say that the [OS](#) has allocated 8192 (0x2000) bytes at address 0x008c0000. Thus, the block is the bytes starting from address 0x008c0000 to 0x008c1fff inclusive.

After the block, that is, starting from address 0x008c2000 there is nothing at all, e.g. the [OS](#) not allocated any memory there. Any attempt to access memory starting from that address will raise an exception.

And let's consider the example in which the program is holding a string that contains 5 characters almost at the end of a block, and that is not a crime.

<sup>174</sup>[wikipedia](#)

0x008c1ff8	'h'
0x008c1ff9	'e'
0x008c1ffa	'l'
0x008c1ffb	'l'
0x008c1ffc	'o'
0x008c1ffd	'\x00'
0x008c1ffe	random noise
0x008c1fff	random noise

So, in normal conditions the program calls `strlen()`, passing it a pointer to the string 'hello' placed in memory at address 0x008c1ff8. `strlen()` reads one byte at a time until 0x008c1ffd, where there's a zero byte, and then it stops.

Now if we implement our own `strlen()` reading 16 bytes at once, starting at any address, aligned or not, `MOVDQU` may attempt to load 16 bytes at once at address 0x008c1ff8 up to 0x008c2008, and then an exception will be raised. That situation is to be avoided, of course.

So then we'll work only with the addresses aligned on a 16 bytes boundary, which in combination with the knowledge that the OS' page size is usually aligned on a 16-byte boundary gives us some warranty that our function will not read from unallocated memory.

Let's get back to our function.

`_mm_setzero_si128()`—is a macro generating `pxor xmm0, xmm0`—it just clears the XMM0 register.

`_mm_load_si128()`—is a macro for `MOVDQA`, it just loads 16 bytes from the address into the XMM1 register.

`_mm_cmpeq_epi8()`—is a macro for `PCMPEQB`, an instruction that compares two XMM-registers bitwise.

And if some byte is equals to the one in the other register, there will be 0xff at this point in the result or 0 if otherwise.

For example:

```
XMM1: 0x11223344556677880000000000000000
XMM0: 0x11ab3444007877881111111111111111
```

After the execution of `pcmpeqb xmm1, xmm0`, the XMM1 register contains:

```
XMM1: 0xff0000ff0000ffff0000000000000000
```

In our case, this instruction compares each 16-byte block with a block of 16 zero-bytes, which has been set in the XMM0 register by `pxor xmm0, xmm0`.

The next macro is `_mm_movemask_epi8()`—that is the `PMOVMASKB` instruction.

It is very useful with `PCMPEQB`.

```
pmovmskb eax, xmm1
```

This instruction sets first EAX bit to 1 if the most significant bit of the first byte in XMM1 is 1. In other words, if the first byte of the XMM1 register is 0xff, then the first bit of EAX is to be 1, too.

If the second byte in the XMM1 register is 0xff, then the second bit in EAX is to be set to 1. In other words, the instruction is answering the question "which bytes in XMM1 has the most significant bit set, or greater than 0x7f", and returns 16 bits in the EAX register. The other bits in the EAX register are to be cleared.

By the way, do not forget about this quirk of our algorithm. There might be 16 bytes in the input like:

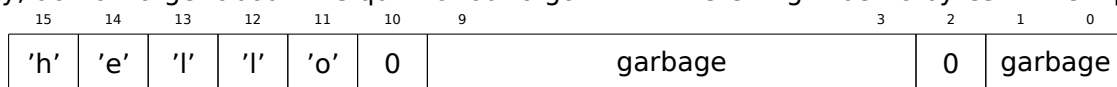

It is the 'hello' string, terminating zero, and some random noise in memory.

If we load these 16 bytes into XMM1 and compare them with the zeroed XMM0, we are getting something like <sup>175</sup>:

```
XMM1: 0x0000ff0000000000000000ff00000000
```

This means that the instruction found two zero bytes, and it is not surprising.

`PMOVMASKB` in our case will set EAX to `0b0010000000100000`.

Obviously, our function must take only the first zero bit and ignore the rest.

<sup>175</sup>An order from MSB to LSB<sup>176</sup> is used here.

The next instruction is BSF (*Bit Scan Forward*).

This instruction finds the first bit set to 1 and stores its position into the first operand.

EAX=0b0010000000100000

After the execution of `bsf eax, eax`, EAX contains 5, meaning 1 has been found at the 5th bit position (starting from zero).

MSVC has a macro for this instruction: `_BitScanForward`.

Now it is simple. If a zero byte has been found, its position is added to what we have already counted and now we have the return result.

Almost all.

By the way, it is also has to be noted that the MSVC compiler emitted two loop bodies side by side, for optimization.

By the way, SSE 4.2 (that appeared in Intel Core i7) offers more instructions where these string manipulations might be even easier: <http://go.yurichev.com/17331>

## 1.37 64 bits

### 1.37.1 x86-64

It is a 64-bit extension to the x86 architecture.

From the reverse engineer's perspective, the most important changes are:

- Almost all registers (except FPU and SIMD) were extended to 64 bits and got a R- prefix. 8 additional registers wer added. Now GPR's are: RAX, RBX, RCX, RDX, RBP, RSP, RSI, RDI, R8, R9, R10, R11, R12, R13, R14, R15.

It is still possible to access the *older* register parts as usual. For example, it is possible to access the lower 32-bit part of the RAX register using EAX:

Byte number:							
7th	6th	5th	4th	3rd	2nd	1st	0th
RAX <sup>x64</sup>							
						EAX	
						AX	
						AH	AL

The new R8-R15 registers also have their *lower parts*: R8D-R15D (lower 32-bit parts), R8W-R15W (lower 16-bit parts), R8L-R15L (lower 8-bit parts).

Byte number:							
7th	6th	5th	4th	3rd	2nd	1st	0th
R8							
						R8D	
						R8W	
						R8L	

The number of SIMD registers was doubled from 8 to 16: XMM0-XMM15.

- In Win64, the function calling convention is slightly different, somewhat resembling fastcall ( [6.1.3 on page 736](#)). The first 4 arguments are stored in the RCX, RDX, R8, R9 registers, the rest —in the stack. The *caller* function must also allocate 32 bytes so the *callee* may save there 4 first arguments and use these registers for its own needs. Short functions may use arguments just from registers, but larger ones may save their values on the stack.

System V AMD64 ABI (Linux, \*BSD, Mac OS X)[Michael Matz, Jan Hubicka, Andreas Jaeger, Mark Mitchell, *System V Application Binary Interface. AMD64 Architecture Processor Supplement*, (2013)]<sup>177</sup> also somewhat resembles fastcall, it uses 6 registers RDI, RSI, RDX, RCX, R8, R9 for the first 6 arguments. All the rest are passed via the stack.

See also the section on calling conventions ( [6.1 on page 735](#)).

- The C/C++ *int* type is still 32-bit for compatibility.

<sup>177</sup>Also available as <https://software.intel.com/sites/default/files/article/402129/mpx-linux64-abi.pdf>

- All pointers are 64-bit now.

Since now the number of registers is doubled, the compilers have more space for maneuvering called [register allocation](#). For us this implies that the emitted code containing less number of local variables.

For example, the function that calculates the first S-box of the DES encryption algorithm processes 32/64/128/256 values at once (depending on DES\_type type (uint32, uint64, SSE2 or AVX)) using the bitslice DES method (read more about this technique here ( [1.36 on page 408](#))):

```

/*
 * Generated S-box files.
 *
 * This software may be modified, redistributed, and used for any purpose,
 * so long as its origin is acknowledged.
 *
 * Produced by Matthew Kwan - March 1998
 */

#ifdef _WIN64
#define DES_type unsigned __int64
#else
#define DES_type unsigned int
#endif

void
s1 (
    DES_type    a1,
    DES_type    a2,
    DES_type    a3,
    DES_type    a4,
    DES_type    a5,
    DES_type    a6,
    DES_type    *out1,
    DES_type    *out2,
    DES_type    *out3,
    DES_type    *out4
) {
    DES_type    x1, x2, x3, x4, x5, x6, x7, x8;
    DES_type    x9, x10, x11, x12, x13, x14, x15, x16;
    DES_type    x17, x18, x19, x20, x21, x22, x23, x24;
    DES_type    x25, x26, x27, x28, x29, x30, x31, x32;
    DES_type    x33, x34, x35, x36, x37, x38, x39, x40;
    DES_type    x41, x42, x43, x44, x45, x46, x47, x48;
    DES_type    x49, x50, x51, x52, x53, x54, x55, x56;

    x1 = a3 & ~a5;
    x2 = x1 ^ a4;
    x3 = a3 & ~a4;
    x4 = x3 | a5;
    x5 = a6 & x4;
    x6 = x2 ^ x5;
    x7 = a4 & ~a5;
    x8 = a3 ^ a4;
    x9 = a6 & ~x8;
    x10 = x7 ^ x9;
    x11 = a2 | x10;
    x12 = x6 ^ x11;
    x13 = a5 ^ x5;
    x14 = x13 & x8;
    x15 = a5 & ~a4;
    x16 = x3 ^ x14;
    x17 = a6 | x16;
    x18 = x15 ^ x17;
    x19 = a2 | x18;
    x20 = x14 ^ x19;
    x21 = a1 & x20;
    x22 = x12 ^ ~x21;
    *out2 ^= x22;
    x23 = x1 | x5;
    x24 = x23 ^ x8;
    x25 = x18 & ~x2;

```



```

x26 = a2 & ~x25;
x27 = x24 ^ x26;
x28 = x6 | x7;
x29 = x28 ^ x25;
x30 = x9 ^ x24;
x31 = x18 & ~x30;
x32 = a2 & x31;
x33 = x29 ^ x32;
x34 = a1 & x33;
x35 = x27 ^ x34;
*out4 ^= x35;
x36 = a3 & x28;
x37 = x18 & ~x36;
x38 = a2 | x3;
x39 = x37 ^ x38;
x40 = a3 | x31;
x41 = x24 & ~x37;
x42 = x41 | x3;
x43 = x42 & ~a2;
x44 = x40 ^ x43;
x45 = a1 & ~x44;
x46 = x39 ^ ~x45;
*out1 ^= x46;
x47 = x33 & ~x9;
x48 = x47 ^ x39;
x49 = x4 ^ x36;
x50 = x49 & ~x5;
x51 = x42 | x18;
x52 = x51 ^ a5;
x53 = a2 & ~x52;
x54 = x50 ^ x53;
x55 = a1 | x54;
x56 = x48 ^ ~x55;
*out3 ^= x56;
}

```

There are a lot of local variables. Of course, not all those going into the local stack. Let's compile it with MSVC 2008 with /Ox option:

Listing 1.399: Optimizing MSVC 2008

```

PUBLIC      _s1
; Function compile flags: /Ogtpy
_TEXT      SEGMENT
_x6$ = -20      ; size = 4
_x3$ = -16     ; size = 4
_x1$ = -12     ; size = 4
_x8$ = -8      ; size = 4
_x4$ = -4      ; size = 4
_a1$ = 8       ; size = 4
_a2$ = 12      ; size = 4
_a3$ = 16      ; size = 4
_x33$ = 20     ; size = 4
_x7$ = 20      ; size = 4
_a4$ = 20      ; size = 4
_a5$ = 24      ; size = 4
tv326 = 28     ; size = 4
_x36$ = 28     ; size = 4
_x28$ = 28     ; size = 4
_a6$ = 28     ; size = 4
_out1$ = 32    ; size = 4
_x24$ = 36     ; size = 4
_out2$ = 36    ; size = 4
_out3$ = 40    ; size = 4
_out4$ = 44    ; size = 4
_s1       PROC
    sub     esp, 20                ; 00000014H
    mov     edx, DWORD PTR _a5$[esp+16]
    push   ebx
    mov     ebx, DWORD PTR _a4$[esp+20]

```

```

push    ebp
push    esi
mov     esi, DWORD PTR _a3$[esp+28]
push    edi
mov     edi, ebx
not     edi
mov     ebp, edi
and     edi, DWORD PTR _a5$[esp+32]
mov     ecx, edx
not     ecx
and     ebp, esi
mov     eax, ecx
and     eax, esi
and     ecx, ebx
mov     DWORD PTR _x1$[esp+36], eax
xor     eax, ebx
mov     esi, ebp
or      esi, edx
mov     DWORD PTR _x4$[esp+36], esi
and     esi, DWORD PTR _a6$[esp+32]
mov     DWORD PTR _x7$[esp+32], ecx
mov     edx, esi
xor     edx, eax
mov     DWORD PTR _x6$[esp+36], edx
mov     edx, DWORD PTR _a3$[esp+32]
xor     edx, ebx
mov     ebx, esi
xor     ebx, DWORD PTR _a5$[esp+32]
mov     DWORD PTR _x8$[esp+36], edx
and     ebx, edx
mov     ecx, edx
mov     edx, ebx
xor     edx, ebp
or      edx, DWORD PTR _a6$[esp+32]
not     ecx
and     ecx, DWORD PTR _a6$[esp+32]
xor     edx, edi
mov     edi, edx
or      edi, DWORD PTR _a2$[esp+32]
mov     DWORD PTR _x3$[esp+36], ebp
mov     ebp, DWORD PTR _a2$[esp+32]
xor     edi, ebx
and     edi, DWORD PTR _a1$[esp+32]
mov     ebx, ecx
xor     ebx, DWORD PTR _x7$[esp+32]
not     edi
or      ebx, ebp
xor     edi, ebx
mov     ebx, edi
mov     edi, DWORD PTR _out2$[esp+32]
xor     ebx, DWORD PTR [edi]
not     eax
xor     ebx, DWORD PTR _x6$[esp+36]
and     eax, edx
mov     DWORD PTR [edi], ebx
mov     ebx, DWORD PTR _x7$[esp+32]
or      ebx, DWORD PTR _x6$[esp+36]
mov     edi, esi
or      edi, DWORD PTR _x1$[esp+36]
mov     DWORD PTR _x28$[esp+32], ebx
xor     edi, DWORD PTR _x8$[esp+36]
mov     DWORD PTR _x24$[esp+32], edi
xor     edi, ecx
not     edi
and     edi, edx
mov     ebx, edi
and     ebx, ebp
xor     ebx, DWORD PTR _x28$[esp+32]
xor     ebx, eax
not     eax

```

```

mov     DWORD PTR _x33$[esp+32], ebx
and     ebx, DWORD PTR _a1$[esp+32]
and     eax, ebp
xor     eax, ebx
mov     ebx, DWORD PTR _out4$[esp+32]
xor     eax, DWORD PTR [ebx]
xor     eax, DWORD PTR _x24$[esp+32]
mov     DWORD PTR [ebx], eax
mov     eax, DWORD PTR _x28$[esp+32]
and     eax, DWORD PTR _a3$[esp+32]
mov     ebx, DWORD PTR _x3$[esp+36]
or      edi, DWORD PTR _a3$[esp+32]
mov     DWORD PTR _x36$[esp+32], eax
not     eax
and     eax, edx
or      ebx, ebp
xor     ebx, eax
not     eax
and     eax, DWORD PTR _x24$[esp+32]
not     ebp
or      eax, DWORD PTR _x3$[esp+36]
not     esi
and     ebp, eax
or      eax, edx
xor     eax, DWORD PTR _a5$[esp+32]
mov     edx, DWORD PTR _x36$[esp+32]
xor     edx, DWORD PTR _x4$[esp+36]
xor     ebp, edi
mov     edi, DWORD PTR _out1$[esp+32]
not     eax
and     eax, DWORD PTR _a2$[esp+32]
not     ebp
and     ebp, DWORD PTR _a1$[esp+32]
and     edx, esi
xor     eax, edx
or      eax, DWORD PTR _a1$[esp+32]
not     ebp
xor     ebp, DWORD PTR [edi]
not     ecx
and     ecx, DWORD PTR _x33$[esp+32]
xor     ebp, ebx
not     eax
mov     DWORD PTR [edi], ebp
xor     eax, ecx
mov     ecx, DWORD PTR _out3$[esp+32]
xor     eax, DWORD PTR [ecx]
pop     edi
pop     esi
xor     eax, ebx
pop     ebp
mov     DWORD PTR [ecx], eax
pop     ebx
add     esp, 20
ret     0
_s1     ENDP

```

5 variables were allocated in the local stack by the compiler.

Now let's try the same thing in the 64-bit version of MSVC 2008:

Listing 1.400: Optimizing MSVC 2008

```

a1$ = 56
a2$ = 64
a3$ = 72
a4$ = 80
x36$1$ = 88
a5$ = 88
a6$ = 96
out1$ = 104
out2$ = 112

```

out3\$ = 120

out4\$ = 128

s1 PROC

\$LN3:

```
mov     QWORD PTR [rsp+24], rbx
mov     QWORD PTR [rsp+32], rbp
mov     QWORD PTR [rsp+16], rdx
mov     QWORD PTR [rsp+8], rcx
push    rsi
push    rdi
push    r12
push    r13
push    r14
push    r15
mov     r15, QWORD PTR a5$[rsp]
mov     rcx, QWORD PTR a6$[rsp]
mov     rbp, r8
mov     r10, r9
mov     rax, r15
mov     rdx, rbp
not     rax
xor     rdx, r9
not     r10
mov     r11, rax
and     rax, r9
mov     rsi, r10
mov     QWORD PTR x36$1$[rsp], rax
and     r11, r8
and     rsi, r8
and     r10, r15
mov     r13, rdx
mov     rbx, r11
xor     rbx, r9
mov     r9, QWORD PTR a2$[rsp]
mov     r12, rsi
or      r12, r15
not     r13
and     r13, rcx
mov     r14, r12
and     r14, rcx
mov     rax, r14
mov     r8, r14
xor     r8, rbx
xor     rax, r15
not     rbx
and     rax, rdx
mov     rdi, rax
xor     rdi, rsi
or      rdi, rcx
xor     rdi, r10
and     rbx, rdi
mov     rcx, rdi
or      rcx, r9
xor     rcx, rax
mov     rax, r13
xor     rax, QWORD PTR x36$1$[rsp]
and     rcx, QWORD PTR a1$[rsp]
or      rax, r9
not     rcx
xor     rcx, rax
mov     rax, QWORD PTR out2$[rsp]
xor     rcx, QWORD PTR [rax]
xor     rcx, r8
mov     QWORD PTR [rax], rcx
mov     rax, QWORD PTR x36$1$[rsp]
mov     rcx, r14
or      rax, r8
or      rcx, r11
mov     r11, r9
xor     rcx, rdx
```

```

mov     QWORD PTR x36$1$[rsp], rax
mov     r8, rsi
mov     rdx, rcx
xor     rdx, r13
not     rdx
and     rdx, rdi
mov     r10, rdx
and     r10, r9
xor     r10, rax
xor     r10, rbx
not     rbx
and     rbx, r9
mov     rax, r10
and     rax, QWORD PTR a1$[rsp]
xor     rbx, rax
mov     rax, QWORD PTR out4$[rsp]
xor     rbx, QWORD PTR [rax]
xor     rbx, rcx
mov     QWORD PTR [rax], rbx
mov     rbx, QWORD PTR x36$1$[rsp]
and     rbx, rbp
mov     r9, rbx
not     r9
and     r9, rdi
or      r8, r11
mov     rax, QWORD PTR out1$[rsp]
xor     r8, r9
not     r9
and     r9, rcx
or      rdx, rbp
mov     rbp, QWORD PTR [rsp+80]
or      r9, rsi
xor     rbx, r12
mov     rcx, r11
not     rcx
not     r14
not     r13
and     rcx, r9
or      r9, rdi
and     rbx, r14
xor     r9, r15
xor     rcx, rdx
mov     rdx, QWORD PTR a1$[rsp]
not     r9
not     rcx
and     r13, r10
and     r9, r11
and     rcx, rdx
xor     r9, rbx
mov     rbx, QWORD PTR [rsp+72]
not     rcx
xor     rcx, QWORD PTR [rax]
or      r9, rdx
not     r9
xor     rcx, r8
mov     QWORD PTR [rax], rcx
mov     rax, QWORD PTR out3$[rsp]
xor     r9, r13
xor     r9, QWORD PTR [rax]
xor     r9, r8
mov     QWORD PTR [rax], r9
pop     r15
pop     r14
pop     r13
pop     r12
pop     rdi
pop     rsi
ret     0

```

s1 ENDP

Nothing was allocated in the local stack by the compiler, x36 is synonym for a5. By the way, there are CPUs with much more [GPR's](#), e.g. Itanium (128 registers).

### 1.37.2 ARM

64-bit instructions appeared in ARMv8.

### 1.37.3 Float point numbers

How floating point numbers are processed in x86-64 is explained here: [1.38](#).

### 1.37.4 64-bit architecture criticism

Some people has irritation sometimes: now one needs twice as much memory for storing pointers, including cache memory, despite the fact that x64 [CPUs](#) can address only 48 bits of external [RAM](#).

Pointers have gone out of favor to the point now where I had to flame about it because on my 64-bit computer that I have here, if I really care about using the capability of my machine I find that I'd better not use pointers because I have a machine that has 64-bit registers but it only has 2 gigabytes of RAM. So a pointer never has more than 32 significant bits to it. But every time I use a pointer it's costing me 64 bits and that doubles the size of my data structure. Worse, it goes into the cache and half of my cache is gone and that costs cash—cache is expensive.

So if I'm really trying to push the envelope now, I have to use arrays instead of pointers. I make complicated macros so that it looks like I'm using pointers, but I'm not really.

( Donald Knuth in "Coders at Work: Reflections on the Craft of Programming ". )

Some people make their own memory allocators. It's interesting to know about [CryptoMiniSat<sup>178</sup>](#) case. This program rarely uses more than 4GiB of [RAM](#), but it uses pointers heavily. So it requires less memory on 32-bit architecture than on 64-bit one. To mitigate this problem, author made his own allocator (in *clauseallocator.h|cpp* files), which allows to have access to allocated memory using 32-bit identifiers instead of 64-bit pointers.

## 1.38 Working with floating point numbers using SIMD

Of course, the [FPU](#) has remained in x86-compatible processors when the [SIMD](#) extensions were added. The [SIMD](#) extensions (SSE2) offer an easier way to work with floating-point numbers.

The number format remains the same (IEEE 754).

So, modern compilers (including those generating for x86-64) usually use [SIMD](#) instructions instead of FPU ones.

It can be said that it's good news, because it's easier to work with them.

We are going to reuse the examples from the FPU section here: [1.25 on page 218](#).

### 1.38.1 Simple example

```
#include <stdio.h>

double f (double a, double b)
{
    return a/3.14 + b*4.1;
};

int main()
{
    printf ("%f\n", f(1.2, 3.4));
};
```

<sup>178</sup><https://github.com/msoos/cryptominisat/>

Listing 1.401: Optimizing MSVC 2012 x64

```

__real@4010666666666666 DQ 0401066666666666r ; 4.1
__real@40091eb851eb851f DQ 040091eb851eb851fr ; 3.14

a$ = 8
b$ = 16
f PROC
    divsd    xmm0, QWORD PTR __real@40091eb851eb851f
    mulsd    xmm1, QWORD PTR __real@4010666666666666
    addsd    xmm0, xmm1
    ret      0
f ENDP

```

The input floating point values are passed in the XMM0-XMM3 registers, all the rest—via the stack <sup>179</sup>.

*a* is passed in XMM0, *b*—via XMM1.

The XMM-registers are 128-bit (as we know from the section about SIMD: 1.36 on page 408), but the *double* values are 64 bit, so only lower register half is used.

DIVSD is an SSE-instruction that stands for “Divide Scalar Double-Precision Floating-Point Values”, it just divides one value of type *double* by another, stored in the lower halves of operands.

The constants are encoded by compiler in IEEE 754 format.

MULSD and ADDSD work just as the same, but do multiplication and addition.

The result of the function’s execution in type *double* is left in the in XMM0 register.

That is how non-optimizing MSVC works:

Listing 1.402: MSVC 2012 x64

```

__real@4010666666666666 DQ 0401066666666666r ; 4.1
__real@40091eb851eb851f DQ 040091eb851eb851fr ; 3.14

a$ = 8
b$ = 16
f PROC
    movsdx   QWORD PTR [rsp+16], xmm1
    movsdx   QWORD PTR [rsp+8], xmm0
    movsdx   xmm0, QWORD PTR a$[rsp]
    divsd    xmm0, QWORD PTR __real@40091eb851eb851f
    movsdx   xmm1, QWORD PTR b$[rsp]
    mulsd    xmm1, QWORD PTR __real@4010666666666666
    addsd    xmm0, xmm1
    ret      0
f ENDP

```

Slightly redundant. The input arguments are saved in the “shadow space” ( 1.14.2 on page 101), but only their lower register halves, i.e., only 64-bit values of type *double*. GCC produces the same code.

## x86

Let’s also compile this example for x86. Despite the fact it’s generating for x86, MSVC 2012 uses SSE2 instructions:

Listing 1.403: Non-optimizing MSVC 2012 x86

```

tv70 = -8 ; size = 8
_a$ = 8 ; size = 8
_b$ = 16 ; size = 8
_f PROC
    push    ebp
    mov     ebp, esp
    sub     esp, 8
    movsd   xmm0, QWORD PTR _a$[ebp]

```

<sup>179</sup>MSDN: Parameter Passing

```

    divsd    xmm0, QWORD PTR __real@40091eb851eb851f
    movsd    xmm1, QWORD PTR _b$[ebp]
    mulsd    xmm1, QWORD PTR __real@4010666666666666
    addsd    xmm0, xmm1
    movsd    QWORD PTR tv70[ebp], xmm0
    fld     QWORD PTR tv70[ebp]
    mov     esp, ebp
    pop     ebp
    ret     0
_f      ENDP

```

Listing 1.404: Optimizing MSVC 2012 x86

```

tv67 = 8      ; size = 8
_a$ = 8      ; size = 8
_b$ = 16     ; size = 8
_f      PROC
    movsd    xmm1, QWORD PTR _a$[esp-4]
    divsd    xmm1, QWORD PTR __real@40091eb851eb851f
    movsd    xmm0, QWORD PTR _b$[esp-4]
    mulsd    xmm0, QWORD PTR __real@4010666666666666
    addsd    xmm1, xmm0
    movsd    QWORD PTR tv67[esp-4], xmm1
    fld     QWORD PTR tv67[esp-4]
    ret     0
_f      ENDP

```

It's almost the same code, however, there are some differences related to calling conventions: 1) the arguments are passed not in XMM registers, but in the stack, like in the FPU examples ( [1.25 on page 218](#)); 2) the result of the function is returned in ST(0) — in order to do so, it's copied (through local variable tv) from one of the XMM registers to ST(0).



Let's try the optimized example in OllyDbg:

The screenshot shows the CPU window of OllyDbg for the main thread of a module named 'simple'. The assembly window displays the following instructions:

```

01331000 *$ F20F104C24 0 MOVSD XMM1,QWORD PTR SS:[ESP+4]
01331006 * F20F5E0D C02 DIUSD XMM1,QWORD PTR DS:[13320C0]
0133100E * F20F104424 0 MOVSD XMM0,QWORD PTR SS:[ESP+0C]
01331014 * F20F5905 D02 MULSD XMM0,QWORD PTR DS:[13320D0]
0133101C * F20F59C9 ADDSD XMM1,XMM0
01331020 * F20F114C24 0 MOVSD QWORD PTR SS:[ESP+4],XMM1
01331026 * DD4424 04 FLD QWORD PTR SS:[ESP+4]
0133102A * C3 RETN
0133102B * CC INT3
0133102C * CC INT3
0133102D * CC INT3
0133102E * CC INT3
0133102F * CC INT3
01331030 *$ F20F1005 C82 MOVSD XMM0,QWORD PTR DS:[13320C8]
01331038 * 83EC 10 SUB ESP,10
0133103B * F20F114424 0 MOVSD QWORD PTR SS:[ESP+8],XMM0
01331041 * F20F1005 B82 MOVSD XMM0,QWORD PTR DS:[13320B8]
01331049 * F20F110424 MOVSD QWORD PTR SS:[ESP],XMM0
0133104E * E8 ADFFFFFF CALL 01331000
01331053 * DD5C24 08 FSTP QWORD PTR SS:[ESP+8]
01331057 * 83C4 08 ADD ESP,8
0133105A * 68 00303301 PUSH OFFSET 01333000
0133105F * FF15 30203300 CALL DWORD PTR DS:[<&MSUCR110.pr intf>]
01331065 * 83C4 0C ADD ESP,0C
01331068 * 33C0 XOR EAX,EAX
0133106A * C3 RETN
0133106B * CC INT3
0133106C * CC INT3
0133106D * CC INT3
0133106E * CC INT3
0133106F * CC INT3
01331070 * B8 4D5A0000 MOV EAX,5A4D
01331075 * 66:3905 0000 CMP WORD PTR DS:[<STRUCT IMAGE_DOS_HEAD
0133107C * 74 04 JE SHORT 01331082
0133107E * 33C0 XOR EAX,EAX
01331080 * EB 34 JMP SHORT 013310B6
01331082 * 8B0D 3C003300 MOV ECX,DWORD PTR DS:[133003C]
01331088 * 81B9 00003300 CMP DWORD PTR DS:[ECX+<STRUCT IMAGE_DOS_
01331092 * 75 EA JNE SHORT 0133107E
01331094 * B8 0B010000 MOV EAX,10B
01331099 * 66:3951 1800 CMP WORD PTR DS:[ECX+1330018],0x

```

The registers window shows the following values:

```

Registers (FPU)
EAX 60F88634 MSUCR110.__initenv
ECX 0066D530
EDX 00000000
EBX 00000000
ESP 0017FBC0
EBP 0017FC10
ESI 00000001
EDI 00000000
EIP 01331006 simple.01331006
C 0 ES 002B 32bit 0(FFFFFFFF)
P 0 CS 0023 32bit 0(FFFFFFFF)
A 0 SS 002B 32bit 0(FFFFFFFF)
Z 0 DS 002B 32bit 0(FFFFFFFF)
S 0 FS 0053 32bit 7EFDD000(FFF)
T 0 GS 002B 32bit 0(FFFFFFFF)
D 0
O 0 LastErr 00000000 ERROR_SUCCESS
EFL 00000202 (NO,NB,NE,A,NS,PO,GE,G)
ST0 empty 0.0
ST1 empty 0.0
ST2 empty 0.0
ST3 empty 0.0
ST4 empty 0.0
ST5 empty 0.0
ST6 empty 0.0
ST7 empty 0.0
FST 0000 Cond 0 0 0 0 Err 0 0 0 0 0 0 0 (GT)
FCW 027F Prec NEAR,53 Mask 1 1 1 1 1 1
Last cmd 0000:00000000
XMM0 0.0 1.2000000000000000
XMM1 0.0 3.1400000000000000
XMM2 0.0 0.0
XMM3 0.0 0.0
XMM4 0.0 0.0
XMM5 0.0 0.0
XMM6 0.0 0.0
XMM7 0.0 0.0
MXCSR 00001F80 FZ 0 DZ 0 Err 0 0 0 0 0 0
Rnd NEAR Mask 1 1 1 1 1 1

```

The memory dump window shows the hex dump of the stack, with the current instruction pointer at 0017FBC0. The dump shows the stack frame for the current function, with the return address at 01331053.

Figure 1.114: OllyDbg: MOVSD loads the value of  $a$  into XMM1

CPU - main thread, module simple

01331000	F20F104C24 0	MOVSD XMM1,QWORD PTR SS:[ESP+4]			
01331006	F20F5E0D C82	DIVSD XMM1,QWORD PTR DS:[13320C0]	FLOAT 3.14000		
0133100E	F20F104424 0	MOVSD XMM0,QWORD PTR SS:[ESP+0C]	FLOAT 3.40000		
01331014	F20F5905 D82	MULSD XMM0,QWORD PTR DS:[13320D0]	FLOAT 4.10000		
0133101C	F20F58C8	ADDSD XMM1,XMM0			
01331020	F20F114C24 0	MOVSD QWORD PTR SS:[ESP+4],XMM1			
01331026	DD4424 04	FLD QWORD PTR SS:[ESP+4]			
0133102A		RETN			
0133102B		CC			
0133102C		INT3			
0133102C		CC			
0133102D		INT3			
0133102E		CC			
0133102F		INT3			
01331030	F20F1005 D82	MOVSD XMM0,QWORD PTR DS:[13320C8]	FLOAT 3.40000		
01331038	83EC 10	SUB ESP,10			
0133103B	F20F114424 0	MOVSD QWORD PTR SS:[ESP+8],XMM0			
01331041	F20F1005 E82	MOVSD XMM0,QWORD PTR DS:[13320B8]	FLOAT 1.20000		
01331049	F20F110424	MOVSD QWORD PTR SS:[ESP],XMM0			
0133104E	E3 ADFFFF	CALL 01331000			
01331053	DD5C24 08	FSTP QWORD PTR SS:[ESP+8]			
01331057	83C4 08	ADD ESP,8			
0133105A	68 00303301	PUSH OFFSET 01333000			
0133105F	FF15 20203301	CALL QWORD PTR DS:[&MSUCR110.printf]	ASCII "%f"		
01331065	83C4 0C	ADD ESP,0C			
01331068	33C0	XOR EAX,EAX			
0133106A		RETN			
0133106B		CC			
0133106C		INT3			
0133106D		CC			
0133106E		INT3			
0133106F		CC			
01331070	B8 4D5A0000	MOV EAX,5A4D			
01331075	66 3905 0000	CMP WORD PTR DS:[<STRUCT IMAGE_DOS_HEAD			
0133107C	74 04	JE SHORT 01331082			
0133107E	33C0	XOR EAX,EAX			
01331080	EB 34	JMP SHORT 013310B6			
01331082	8B0D 3C003301	MOV ECX,DWORD PTR DS:[133003C]			
01331088	81B9 00003301	CMP DWORD PTR DS:[ECX+<STRUCT IMAGE_DOS			
01331092	75 EA	JNE SHORT 0133107E			
01331094	B8 0B010000	MOV EAX,10B			
01331099	66 3981 1800	CMP WORD PTR DS:[ECX+13300181_0x			

Stack [0017FBC0]=3.4000000000000000  
XMM0=0.0, 1.2000000000000000

Registers (FPU)

EAX	68F88634	MSUCR110.__initenv
ECX	0066D530	
EDX	00000000	
EBX	00000000	
ESP	0017FBC0	
EBP	0017FC10	
ESI	00000001	
EDI	00000000	
EIP	0133100E	simple.0133100E

C 0 ES 002B 32bit 0(FFFFFFFF)  
 P 0 CS 0023 32bit 0(FFFFFFFF)  
 A 0 SS 002B 32bit 0(FFFFFFFF)  
 Z 0 DS 002B 32bit 0(FFFFFFFF)  
 S 0 FS 0053 32bit 7EFD0000(FFF)  
 T 0 GS 002B 32bit 0(FFFFFFFF)  
 D 0  
 O 0 LastErr 00000000 ERROR\_SUCCESS  
 EFL 00000202 (NO,NB,NE,A,NS,PO,GE,G)  
 ST0 empty 0.0  
 ST1 empty 0.0  
 ST2 empty 0.0  
 ST3 empty 0.0  
 ST4 empty 0.0  
 ST5 empty 0.0  
 ST6 empty 0.0  
 ST7 empty 0.0

FST 0000 Cond 0 0 0 0 Err 0 0 0 0 0 0 0 0 (GT)  
 FCW 027F Prec NEAR,53 Mask 1 1 1 1 1 1  
 Last cmd 0000:00000000

XMM0	0.0	1.2000000000000000
XMM1	0.0	0.3821656050955414
XMM2	0.0	0.0
XMM3	0.0	0.0
XMM4	0.0	0.0
XMM5	0.0	0.0
XMM6	0.0	0.0
XMM7	0.0	0.0

MXCSR 0001FA0 FZ 0 DZ 0 Err 1 0 0 0 0 0  
Rnd NEAR Mask 1 1 1 1 1 1

Address	Hex dump	ASCII (A)	0017FBC0	01331053	S>30
01333000	56 0A 00 00 00 00 00 00 00 00 00 00 00 00 00 00	%f	33333333	3333	
01333010	01 00 00 00 00 00 00 00 00 00 00 00 00 00 00 00	0	0017FBC4	3FF33333	33e?
01333020	FE FF FF FF FF FF FF BB 15 5B 87 44 EA A4 78	#	0017FBC8	33333333	3333
01333030	00 00 00 00 00 00 00 00 01 00 00 00 00 AC 66 00	0ff	0017FBD0	400B3333	3330
01333040	30 D5 66 00 00 00 00 00 00 00 00 00 00 00 00 00		0017FBD4	01331271	q*30
01333050	00 00 00 00 00 00 00 00 00 00 00 00 00 00 00 00		0017FBD8	00000001	0
01333060	00 00 00 00 00 00 00 00 00 00 00 00 00 00 00 00		0017FBDc	0066AC00	mf
01333070	00 00 00 00 00 00 00 00 00 00 00 00 00 00 00 00		0017FBE0	0066D530	0ff
01333080	00 00 00 00 00 00 00 00 00 00 00 00 00 00 00 00		0017FBE4	874CE3AB	lwL3
01333090	00 00 00 00 00 00 00 00 00 00 00 00 00 00 00 00		0017FBE8	00000000	
013330A0	00 00 00 00 00 00 00 00 00 00 00 00 00 00 00 00		0017FBEC	00000000	
013330B0	00 00 00 00 00 00 00 00 00 00 00 00 00 00 00 00		0017FBF0	7EFD0000	pt"
013330C0	00 00 00 00 00 00 00 00 00 00 00 00 00 00 00 00		0017FBF4	00000000	
013330D0	00 00 00 00 00 00 00 00 00 00 00 00 00 00 00 00		0017FBF8	0017FBE4	0r#
013330E0	00 00 00 00 00 00 00 00 00 00 00 00 00 00 00 00		0017FBFC	0000020A	K0
013330F0	00 00 00 00 00 00 00 00 00 00 00 00 00 00 00 00		0017FC00	0017FC00	U#
01333100	00 00 00 00 00 00 00 00 00 00 00 00 00 00 00 00		0017FC04	013316F9	-_30
01333110	00 00 00 00 00 00 00 00 00 00 00 00 00 00 00 00		0017FC08	866834F3	e4h#

RETURN from simple.01331000 to simple.01331013  
RETURN from simple.01331030 to simple.01331033  
Pointer to next SEH record  
SE handler

Figure 1.115: OllyDbg: DIVSD calculated quotient and stored it in XMM1

CPU - main thread, module simple

01331000	F20F104C24 0	MOUSD XMM1, QWORD PTR SS:[ESP+4]			
01331006	F20F5E00 C824	DIVSD XMM1, QWORD PTR DS:[13320C0]	FLOAT 3.14000		
0133100E	F20F104424 0	MOUSD XMM0, QWORD PTR SS:[ESP+0C]			
01331014	F20F5905 002	MULSD XMM0, QWORD PTR DS:[13320D0]	FLOAT 4.10000		
0133101C	F20F58C8	ADDSD XMM1, XMM0	FLOAT 0.0, 1		
01331020	F20F114C24 0	MOUSD QWORD PTR SS:[ESP+4], XMM1			
01331026	DD4424 04	FLD QWORD PTR SS:[ESP+4]			
0133102A	C3	RETN			
0133102B	CC	INT3			
0133102C	CC	INT3			
0133102D	CC	INT3			
0133102E	CC	INT3			
0133102F	CC	INT3			
01331030	F20F1005 C824	MOUSD XMM0, QWORD PTR DS:[13320C8]	FLOAT 3.40000		
01331038	83EC 10	SUB ESP, 10			
0133103B	F20F114424 0	MOUSD QWORD PTR SS:[ESP+8], XMM0			
01331041	F20F1005 E824	MOUSD XMM0, QWORD PTR DS:[13320B8]	FLOAT 1.20000		
01331049	F20F110424	MOUSD QWORD PTR SS:[ESP], XMM0			
0133104E	E3 A0FFFFFF	CALL 01331000			
01331053	DD5C24 08	FSTP QWORD PTR SS:[ESP+8]			
01331057	83C4 08	ADD ESP, 8			
0133105A	68 00303301	PUSH OFFSET 01333000			
0133105F	FF15 90203300	CALL QWORD PTR DS:[&MSUCR110.printf]	ASCII "%f"		
01331065	83C4 0C	ADD ESP, 0C			
01331068	33C0	XOR EAX, EAX			
0133106A	C3	RETN			
0133106B	CC	INT3			
0133106C	CC	INT3			
0133106D	CC	INT3			
0133106E	CC	INT3			
0133106F	CC	INT3			
01331070	B8 4D5A0000	MOV EAX, 5A4D			
01331075	66 3905 0000	CMP WORD PTR DS:[<STRUCT IMAGE_DOS_HEAD			
0133107C	74 04	JE SHORT 01331082			
0133107E	33C0	XOR EAX, EAX			
01331080	EB 34	JMP SHORT 013310B6			
01331082	8B0D 3C003300	MOV ECX, DWORD PTR DS:[133003C]			
01331088	81B9 00003300	CMP DWORD PTR DS:[ECX+<STRUCT IMAGE_DOS			
01331092	75 EA	JNE SHORT 0133107E			
01331094	B8 0B010000	MOV EAX, 10B			
01331099	66 3981 1800	CMP WORD PTR DS:[ECX+13300181] AX			

XMM0=0.0, 13.940000000000000  
XMM1=0.0, 0.3821656050955414

Registers (FPU)  
EAX 68F88634 MSUCR110.\_\_initenv  
ECX 0066D530  
EDX 00000000  
EBX 00000000  
ESP 0017FBC0  
EBP 0017FC10  
ESI 00000001  
EDI 00000000  
EIP 0133101C simple.0133101C  
C 0 ES 002B 32bit 0(FFFFFFFF)  
P 0 CS 0023 32bit 0(FFFFFFFF)  
A 0 SS 002B 32bit 0(FFFFFFFF)  
Z 0 DS 002B 32bit 0(FFFFFFFF)  
S 0 FS 0053 32bit 7EFD0000(FFF)  
T 0 GS 002B 32bit 0(FFFFFFFF)  
D 0  
O 0  
LastErr 00000000 ERROR\_SUCCESS  
EFL 00000202 (NO, NB, NE, A, NS, PO, GE, G)  
ST0 empty 0.0  
ST1 empty 0.0  
ST2 empty 0.0  
ST3 empty 0.0  
ST4 empty 0.0  
ST5 empty 0.0  
ST6 empty 0.0  
ST7 empty 0.0  
3 2 1 0 E S P U O Z D I  
FST 0000 Cond 0 0 0 0 Err 0 0 0 0 0 0 0 (GT)  
FCW 027F Prec NEAR, 53 Mask 1 1 1 1 1 1  
Last cmd 0000:00000000  
XMM0 0.0 13.940000000000000  
XMM1 0.0 0.3821656050955414  
XMM2 0.0 0.0  
XMM3 0.0 0.0  
XMM4 0.0 0.0  
XMM5 0.0 0.0  
XMM6 0.0 0.0  
XMM7 0.0 0.0  
P U O Z D I  
MXCSR 00001FA0 FZ 0 DZ 0 Err 1 0 0 0 0 0  
Rnd NEAR Mask 1 1 1 1 1 1

Address	Hex dump	ASCII (A)	0017FBC0	01331053	S>30	RETURN from simple.01331000 to simple.013
01333000	56 0A 00 00 00 00 00 00 00 00 00 00 00 00 00 00	FB	0017FBC4	33333333	3333	
01333010	01 00 00 00 00 00 00 00 00 00 00 00 00 00 00 00	FB	0017FBC8	3FF33333	33e?	
01333020	FE FF FF FF FF FF FF FF BB 15 5B 87 44 EA A4 78	FB	0017FBC0	33333333	3333	
01333030	00 00 00 00 00 00 00 00 00 00 01 00 00 00 00 AC 66 00	FB	0017FBD0	400B3333	3330	
01333040	30 D5 66 00 00 00 00 00 00 00 00 00 00 00 00 00	FB	0017FBD4	01331271	q*30	RETURN from simple.01331030 to simple.013
01333050	00 00 00 00 00 00 00 00 00 00 00 00 00 00 00 00	FB	0017FBD8	00000001	0	
01333060	00 00 00 00 00 00 00 00 00 00 00 00 00 00 00 00	FB	0017FBD0	0066AC00	mf	
01333070	00 00 00 00 00 00 00 00 00 00 00 00 00 00 00 00	FB	0017FBE0	0066D530	0ff	
01333080	00 00 00 00 00 00 00 00 00 00 00 00 00 00 00 00	FB	0017FBE4	874CE3AB	lwL3	
01333090	00 00 00 00 00 00 00 00 00 00 00 00 00 00 00 00	FB	0017FBE8	00000000		
013330A0	00 00 00 00 00 00 00 00 00 00 00 00 00 00 00 00	FB	0017FBF0	7EFD0000	FB	
013330B0	00 00 00 00 00 00 00 00 00 00 00 00 00 00 00 00	FB	0017FBF4	00000000		
013330C0	00 00 00 00 00 00 00 00 00 00 00 00 00 00 00 00	FB	0017FBF8	0017FBE4	FB	
013330D0	00 00 00 00 00 00 00 00 00 00 00 00 00 00 00 00	FB	0017FBFC	0000020A	K0	
013330E0	00 00 00 00 00 00 00 00 00 00 00 00 00 00 00 00	FB	0017FC00	0017FC4C	FB	Pointer to next SEH record
013330F0	00 00 00 00 00 00 00 00 00 00 00 00 00 00 00 00	FB	0017FC04	013316F9	FB	SE handler
01333100	00 00 00 00 00 00 00 00 00 00 00 00 00 00 00 00	FB	0017FC08	866834F3	e4h	

Figure 1.116: OllyDbg: MULSD calculated product and stored it in XMM0

CPU - main thread, module simple

Address	Hex dump	Assembly	Comments
01331000	F20F104C24 0	MOUSD XMM1,QWORD PTR SS:[ESP+4]	
01331006	F20F5E0D C021	DIUSD XMM1,QWORD PTR DS:[13320C0]	FLOAT 3.14000
0133100E	F20F104424 0	MOUSD XMM0,QWORD PTR SS:[ESP+0C]	
01331014	F20F5905 D021	MULSD XMM0,QWORD PTR DS:[13320D0]	FLOAT 4.10000
0133101C	F20F59C3	ADDSD XMM1,XMM0	
01331020	F20F110424 0	MOUSD QWORD PTR SS:[ESP+4],XMM1	FLOAT 0.0, 1.00000
01331026	DD4424 04	FLO QWORD PTR SS:[ESP+4]	
0133102A	C3	RETN	
0133102B	CC	INT3	
0133102C	CC	INT3	
0133102D	CC	INT3	
0133102E	CC	INT3	
0133102F	CC	INT3	
01331030	F20F1005 C021	MOUSD XMM0,QWORD PTR DS:[13320C8]	FLOAT 3.40000
01331038	83EC 10	SUB ESP,10	
0133103B	F20F114424 0	MOUSD QWORD PTR SS:[ESP+8],XMM0	
01331041	F20F1005 B021	MOUSD XMM0,QWORD PTR DS:[13320B8]	FLOAT 1.20000
01331049	F20F110424	MOUSD QWORD PTR SS:[ESP],XMM0	
0133104E	E8 ADFFFFFF	CALL 01331000	
01331053	DD5C24 08	FSTP QWORD PTR SS:[ESP+8]	
01331057	83C4 08	ADD ESP,8	
0133105A	68 00303301	PUSH OFFSET 01333000	ASCII "%f0"
0133105F	FF15 30203300	CALL QWORD PTR DS:[&MSUCR110.printf]	
01331065	83C4 0C	ADD ESP,0C	
01331068	33C0	XOR EAX,EAX	
0133106A	C3	RETN	
0133106B	CC	INT3	
0133106C	CC	INT3	
0133106D	CC	INT3	
0133106E	CC	INT3	
0133106F	CC	INT3	
01331070	B8 405A0000	MOV EAX,5A40	
01331075	66:3905 0000	CMPI WORD PTR DS:[<STRUCT IMAGE_DOS_HEAD	
0133107C	74 04	JE SHORT 01331082	
0133107E	33C0	XOR EAX,EAX	
01331080	EB 34	JMP SHORT 013310B6	
01331082	8B00 3C003300	MOV ECX,QWORD PTR DS:[133003C]	
01331089	81B9 00003300	CMPI QWORD PTR DS:[ECX+<STRUCT IMAGE_DOS	
01331092	75 EA	JNE SHORT 0133107E	
01331094	B8 0B010000	MOV EAX,10B	
01331099	66:3901 1800	CMPI WORD PTR DS:[ECX+13300181_0x	

XMM1=0.0, 14.32216560509554  
Stack [0017FBC4]=1.2000000000000000

Registers (FPU)

Register	Value
EAX	60F88634 MSUCR110.__initenv
ECX	00660530
EDX	00000000
EBX	00000000
ESP	0017FBC0
EBP	0017FC10
ESI	00000001
EDI	00000000
EIP	01331020 simple.01331020
C 0	ES 002B 32bit 0(FFFFFFFF)
P 0	CS 0023 32bit 0(FFFFFFFF)
A 0	SS 002B 32bit 0(FFFFFFFF)
Z 0	DS 002B 32bit 0(FFFFFFFF)
S 0	FS 0053 32bit 7EFD0000(FFF)
T 0	GS 002B 32bit 0(FFFFFFFF)
D 0	
0 0	LastErr 00000000 ERROR_SUCCESS
EFL	00000202 (NO,NB,NE,A,NS,PO,GE,G)
ST0	empty 0.0
ST1	empty 0.0
ST2	empty 0.0
ST3	empty 0.0
ST4	empty 0.0
ST5	empty 0.0
ST6	empty 0.0
ST7	empty 0.0
FST	0000 Cond 0 0 0 0 Err 0 0 0 0 0 0 0 0 (GT)
FCW	027F Prec NEAR,53 Mask 1 1 1 1 1 1
Last cmd	0000:00000000
XMM0	0.0 13.9400000000000000
XMM1	0.0 14.32216560509554
XMM2	0.0 0.0
XMM3	0.0 0.0
XMM4	0.0 0.0
XMM5	0.0 0.0
XMM6	0.0 0.0
XMM7	0.0 0.0
MXCSR	0001FA0 FZ 0 DZ 0 Err 1 0 0 0 0 0
	Rnd NEAR Mask 1 1 1 1 1 1

Address	Hex dump	ASCII (A)	Comment
01333000	66 0A 00 00 00 00 00 00 00 00 00 00 00 00 00 00	%f0	
01333010	01 00 00 00 00 00 00 00 00 00 00 00 00 00 00 00	0	
01333020	FE FF FF FF FF FF FF BB 15 58 87 44 EA A4 78	#	
01333030	00 00 00 00 00 00 00 00 01 00 00 00 00 AC 66 00		
01333040	30 05 66 00 00 00 00 00 00 00 00 00 00 00 00 00	0ff	
01333050	00 00 00 00 00 00 00 00 00 00 00 00 00 00 00 00		
01333060	00 00 00 00 00 00 00 00 00 00 00 00 00 00 00 00		
01333070	00 00 00 00 00 00 00 00 00 00 00 00 00 00 00 00		
01333080	00 00 00 00 00 00 00 00 00 00 00 00 00 00 00 00		
01333090	00 00 00 00 00 00 00 00 00 00 00 00 00 00 00 00		
013330A0	00 00 00 00 00 00 00 00 00 00 00 00 00 00 00 00		
013330B0	00 00 00 00 00 00 00 00 00 00 00 00 00 00 00 00		
013330C0	00 00 00 00 00 00 00 00 00 00 00 00 00 00 00 00		
013330D0	00 00 00 00 00 00 00 00 00 00 00 00 00 00 00 00		
013330E0	00 00 00 00 00 00 00 00 00 00 00 00 00 00 00 00		
013330F0	00 00 00 00 00 00 00 00 00 00 00 00 00 00 00 00		
01333100	00 00 00 00 00 00 00 00 00 00 00 00 00 00 00 00		
01333110	00 00 00 00 00 00 00 00 00 00 00 00 00 00 00 00		

01331053 S>30 RETURN from simple.01331000 to simple.01331053

01331053 S>30 RETURN from simple.01331030 to simple.01331053

01333000 33333333 3333

01333004 33333333 3333

01333008 33333333 3333

0133300C 40003333 3300

01333010 01331271 q>30

01333014 00000001 0

01333018 0066AC00 mf

0133301C 0066D530 0ff

01333020 874CE9AB lwL3

01333024 00000000

01333028 00000000

0133302C 7EFD0000

01333030 00000000

01333034 0017FBE4 0rL

01333038 0000028A K0

0133303C 0017FC4C Lf>3

01333040 013316F9 ->30

01333044 866834F3 e4h

Pointer to next SEH record  
SE handler

Figure 1.117: OllyDbg: ADDSD adds value in XMM0 to XMM1

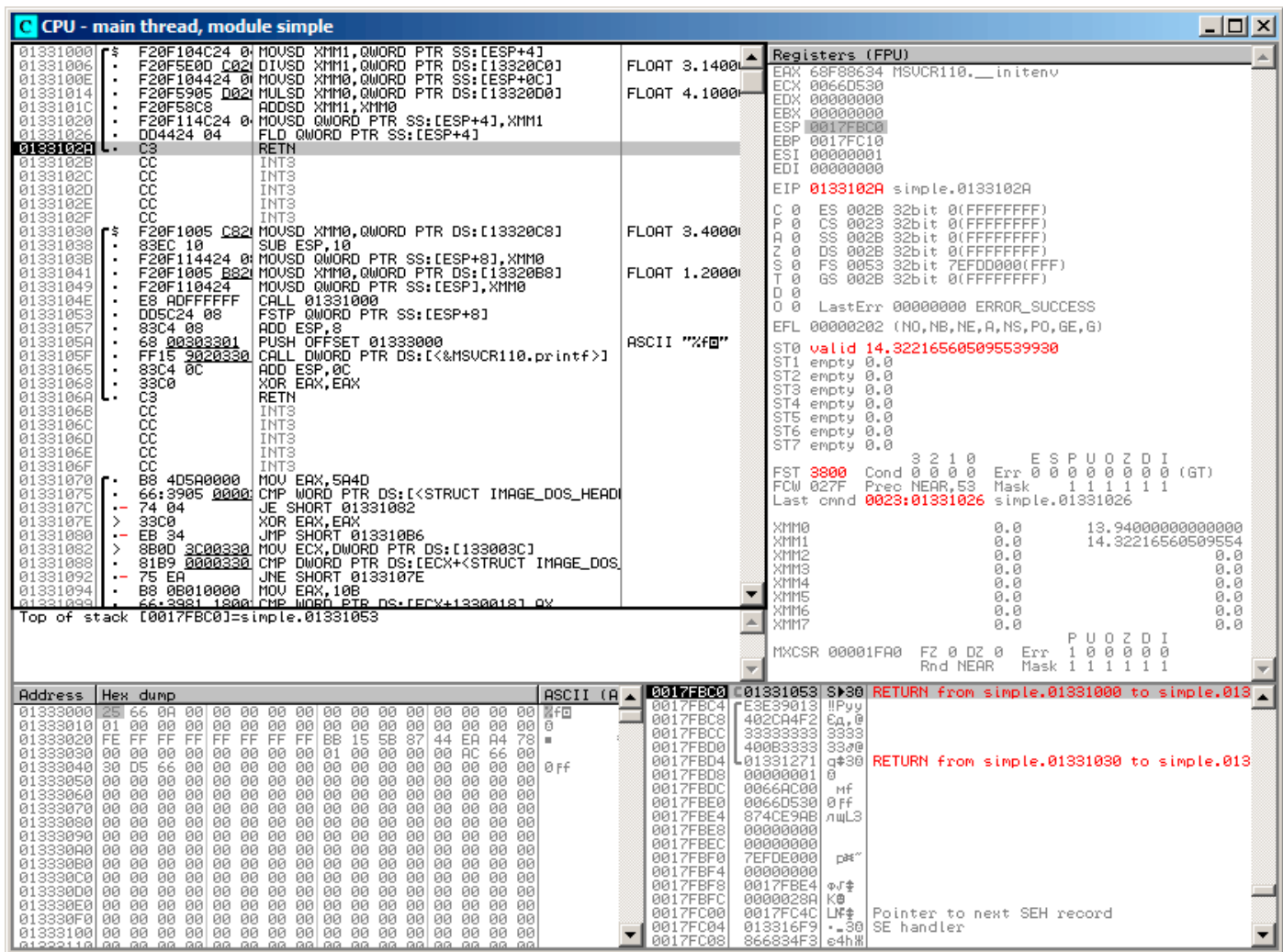

Figure 1.118: OllyDbg: FLD left function result in ST(0)

We see that OllyDbg shows the XMM registers as pairs of *double* numbers, but only the *lower* part is used. Apparently, OllyDbg shows them in that format because the SSE2 instructions (suffixed with *-SD*) are executed right now.

But of course, it's possible to switch the register format and to see their contents as 4 *float*-numbers or just as 16 bytes.

## 1.38.2 Passing floating point number via arguments

```
#include <math.h>
#include <stdio.h>

int main ()
{
    printf ("32.01 ^ 1.54 = %lf\n", pow (32.01,1.54));

    return 0;
}
```

They are passed in the lower halves of the XMM0-XMM3 registers.

Listing 1.405: Optimizing MSVC 2012 x64

```
$SG1354 DB      '32.01 ^ 1.54 = %lf', 0aH, 00H

__real@40400147ae147ae1 DQ 040400147ae147ae1r    ; 32.01
__real@3ff8a3d70a3d70a4 DQ 03ff8a3d70a3d70a4r   ; 1.54

main PROC
    sub     rsp, 40                                ; 00000028H
    movsdx  xmm1, QWORD PTR __real@3ff8a3d70a3d70a4
    movsdx  xmm0, QWORD PTR __real@40400147ae147ae1
    call    pow
    lea    rcx, OFFSET FLAT:$SG1354
    movaps  xmm1, xmm0
    movd   rdx, xmm1
    call    printf
    xor    eax, eax
    add    rsp, 40                                ; 00000028H
    ret    0
main ENDP
```

There is no MOVSDX instruction in Intel and AMD manuals ( [12.1.4 on page 1014](#)), there it is called just MOVSD. So there are two instructions sharing the same name in x86 (about the other see: [.1.6 on page 1030](#)). Apparently, Microsoft developers wanted to get rid of the mess, so they renamed it to MOVSDX. It just loads a value into the lower half of a XMM register.

pow() takes arguments from XMM0 and XMM1, and returns result in XMM0. It is then moved to RDX for printf(). Why? Maybe because printf()—is a variable arguments function?

Listing 1.406: Optimizing GCC 4.4.6 x64

```
.LC2:
    .string "32.01 ^ 1.54 = %lf\n"
main:
    sub     rsp, 8
    movsd  xmm1, QWORD PTR .LC0[rip]
    movsd  xmm0, QWORD PTR .LC1[rip]
    call   pow
    ; result is now in XMM0
    mov    edi, OFFSET FLAT:.LC2
    mov    eax, 1 ; number of vector registers passed
    call   printf
    xor    eax, eax
    add    rsp, 8
    ret

.LC0:
    .long  171798692
    .long  1073259479
.LC1:
    .long  2920577761
    .long  1077936455
```

GCC generates clearer output. The value for printf() is passed in XMM0. By the way, here is a case when 1 is written into EAX for printf()—this implies that one argument will be passed in vector registers, just as the standard requires [Michael Matz, Jan Hubicka, Andreas Jaeger, Mark Mitchell, *System V Application Binary Interface. AMD64 Architecture Processor Supplement*, (2013)] <sup>180</sup>.

<sup>180</sup>Also available as <https://software.intel.com/sites/default/files/article/402129/mpx-linux64-abi.pdf>

### 1.38.3 Comparison example

```
#include <stdio.h>

double d_max (double a, double b)
{
    if (a>b)
        return a;

    return b;
};

int main()
{
    printf ("%f\n", d_max (1.2, 3.4));
    printf ("%f\n", d_max (5.6, -4));
};
```

#### x64

Listing 1.407: Optimizing MSVC 2012 x64

```
a$ = 8
b$ = 16
d_max PROC
    comisd    xmm0, xmm1
    ja       SHORT $LN2@d_max
    movaps   xmm0, xmm1
$LN2@d_max:
    fatret   0
d_max ENDP
```

Optimizing MSVC generates a code very easy to understand.

COMISD is “Compare Scalar Ordered Double-Precision Floating-Point Values and Set EFLAGS”. Essentially, that is what it does.

Non-optimizing MSVC generates more redundant code, but it is still not hard to understand:

Listing 1.408: MSVC 2012 x64

```
a$ = 8
b$ = 16
d_max PROC
    movsdx   QWORD PTR [rsp+16], xmm1
    movsdx   QWORD PTR [rsp+8], xmm0
    movsdx   xmm0, QWORD PTR a$[rsp]
    comisd   xmm0, QWORD PTR b$[rsp]
    jbe      SHORT $LN1@d_max
    movsdx   xmm0, QWORD PTR a$[rsp]
    jmp      SHORT $LN2@d_max
$LN1@d_max:
    movsdx   xmm0, QWORD PTR b$[rsp]
$LN2@d_max:
    fatret   0
d_max ENDP
```

However, GCC 4.4.6 did more optimizations and used the MAXSD (“Return Maximum Scalar Double-Precision Floating-Point Value”) instruction, which just choose the maximum value!

Listing 1.409: Optimizing GCC 4.4.6 x64

```
d_max:
    maxsd    xmm0, xmm1
    ret
```

## x86

Let's compile this example in MSVC 2012 with optimization turned on:

Listing 1.410: Optimizing MSVC 2012 x86

```
_a$ = 8 ; size = 8
_b$ = 16 ; size = 8
_d_max PROC
movsd xmm0, QWORD PTR _a$[esp-4]
comisd xmm0, QWORD PTR _b$[esp-4]
jbe SHORT $LN1@d_max
fld QWORD PTR _a$[esp-4]
ret 0
$LN1@d_max:
fld QWORD PTR _b$[esp-4]
ret 0
_d_max ENDP
```

Almost the same, but the values of *a* and *b* are taken from the stack and the function result is left in ST(0). If we load this example in OllyDbg, we can see how the COMISD instruction compares values and sets/clears the CF and PF flags:

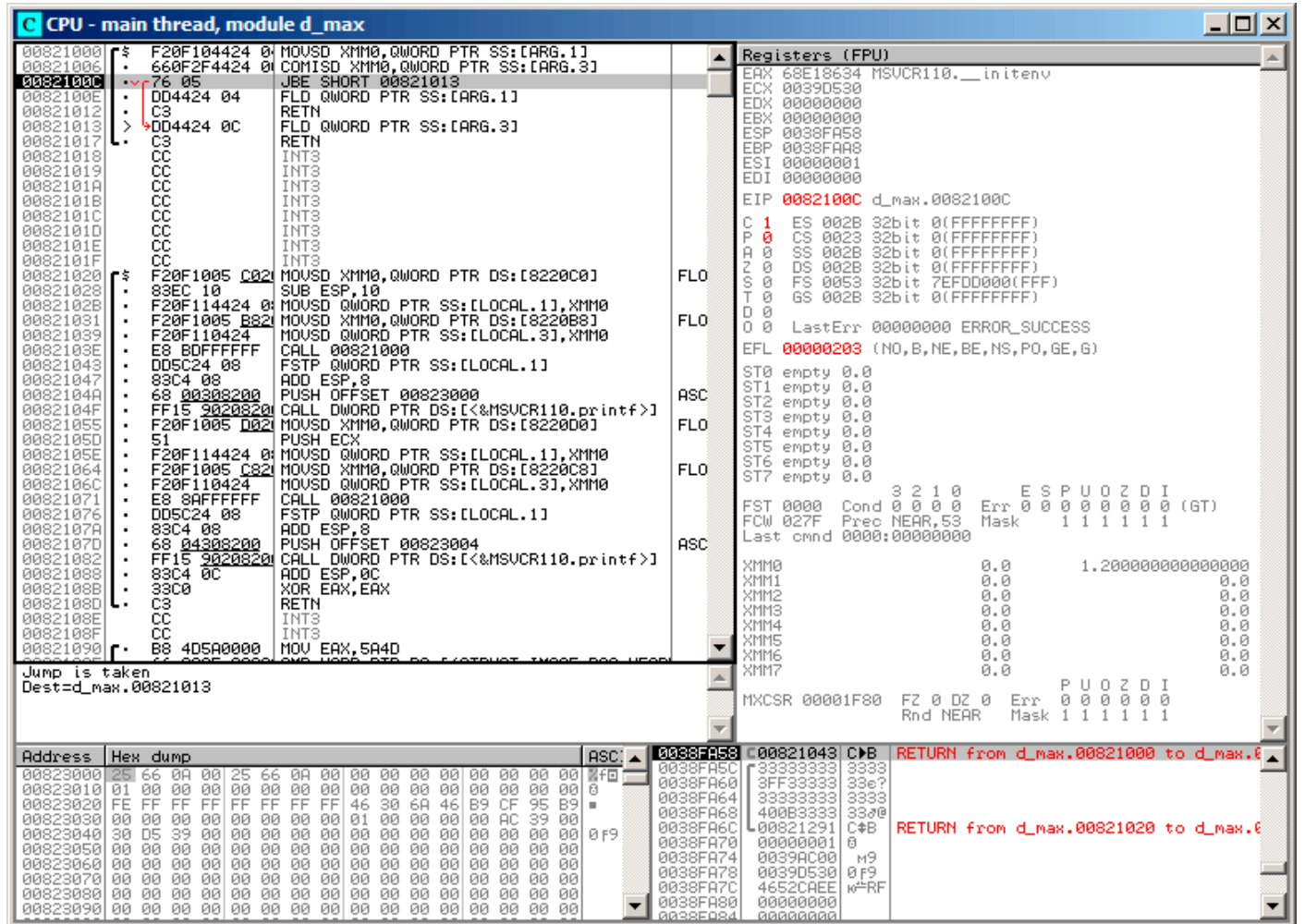

Figure 1.119: OllyDbg: COMISD changed CF and PF flags

## 1.38.4 Calculating machine epsilon: x64 and SIMD

Let's revisit the "calculating machine epsilon" example for *double* listing.1.32.2.

Now we compile it for x64:

Listing 1.411: Optimizing MSVC 2012 x64



```

v$ = 8
calculate_machine_epsilon PROC
    movsdx  QWORD PTR v$[rsp], xmm0
    movaps  xmm1, xmm0
    inc     QWORD PTR v$[rsp]
    movsdx  xmm0, QWORD PTR v$[rsp]
    subsd   xmm0, xmm1
    ret     0
calculate_machine_epsilon ENDP

```

There is no way to add 1 to a value in 128-bit XMM register, so it must be placed into memory.

There is, however, the `ADDSD` instruction (*Add Scalar Double-Precision Floating-Point Values*) which can add a value to the lowest 64-bit half of a XMM register while ignoring the higher one, but MSVC 2012 probably is not that good yet <sup>181</sup>.

Nevertheless, the value is then reloaded to a XMM register and subtraction occurs. `SUBSD` is “Subtract Scalar Double-Precision Floating-Point Values”, i.e., it operates on the lower 64-bit part of 128-bit XMM register. The result is returned in the `XMM0` register.

### 1.38.5 Pseudo-random number generator example revisited

Let’s revisit “pseudo-random number generator example” example listing.1.32.1.

If we compile this in MSVC 2012, it will use the SIMD instructions for the FPU.

Listing 1.412: Optimizing MSVC 2012

```

__real@3f800000 DD 03f800000r ; 1

tv128 = -4
_tmp$ = -4
?float_rand@@YAMXZ PROC
    push    ecx
    call    ?my_rand@@YAIXZ
; EAX=pseudorandom value
    and     eax, 8388607 ; 007fffffH
    or     eax, 1065353216 ; 3f800000H
; EAX=pseudorandom value & 0x007fffff | 0x3f800000
; store it into local stack:
    mov     DWORD PTR _tmp$[esp+4], eax
; reload it as float point number:
    movss  xmm0, DWORD PTR _tmp$[esp+4]
; subtract 1.0:
    subss  xmm0, DWORD PTR __real@3f800000
; move value to ST0 by placing it in temporary variable...
    movss  DWORD PTR tv128[esp+4], xmm0
; ... and reloading it into ST0:
    fld    DWORD PTR tv128[esp+4]
    pop    ecx
    ret    0
?float_rand@@YAMXZ ENDP

```

All instructions have the `-SS` suffix, which stands for “Scalar Single”.

“Scalar” implies that only one value is stored in the register.

“Single”<sup>182</sup> stands for *float* data type.

### 1.38.6 Summary

Only the lower half of XMM registers is used in all examples here, to store number in IEEE 754 format.

Essentially, all instructions prefixed by `-SD` (“Scalar Double-Precision”)—are instructions working with floating point numbers in IEEE 754 format, stored in the lower 64-bit half of a XMM register.

And it is easier than in the FPU, probably because the SIMD extensions were evolved in a less chaotic way than the FPU ones in the past. The stack register model is not used.

<sup>181</sup>As an exercise, you may try to rework this code to eliminate the usage of the local stack.

<sup>182</sup>i.e., single precision.

If you would try to replace *double* with *float*

in these examples, the same instructions will be used, but prefixed with -SS (“Scalar Single-Precision”), for example, MOVSS, COMISS, ADDSS, etc.

“Scalar” implies that the SIMD register containing only one value instead of several.

Instructions working with several values in a register simultaneously have “Packed” in their name.

Needless to say, the SSE2 instructions work with 64-bit IEEE 754 numbers (*double*), while the internal representation of the floating-point numbers in FPU is 80-bit numbers.

Hence, the FPU may produce less round-off errors and as a consequence, FPU may give more precise calculation results.

## 1.39 ARM-specific details

### 1.39.1 Number sign (#) before number

The Keil compiler, IDA and objdump precede all numbers with the “#” number sign, for example: listing.1.22.1.

But when GCC 4.9 generates assembly language output, it doesn’t, for example: listing.3.18.

The ARM listings in this book are somewhat mixed.

It’s hard to say, which method is right. Supposedly, one has to obey the rules accepted in environment he/she works in.

### 1.39.2 Addressing modes

This instruction is possible in ARM64:

```
ldr    x0, [x29,24]
```

This means add 24 to the value in X29 and load the value from this address.

Please note that 24 is inside the brackets. The meaning is different if the number is outside the brackets:

```
ldr    w4, [x1],28
```

This means load the value at the address in X1, then add 28 to X1.

ARM allows you to add or subtract a constant to/from the address used for loading.

And it’s possible to do that both before and after loading.

There is no such addressing mode in x86, but it is present in some other processors, even on PDP-11.

There is a legend that the pre-increment, post-increment, pre-decrement and post-decrement modes in PDP-11,

were “guilty” for the appearance of such C language (which developed on PDP-11) constructs as *\*ptr++*, *\*++ptr*, *\*ptr--*, *\*--ptr*.

By the way, this is one of the hard to memorize C features. This is how it is:

C term	ARM term	C statement	how it works
Post-increment	post-indexed addressing	<i>*ptr++</i>	use <i>*ptr</i> value, then <b>increment</b> <i>ptr</i> pointer
Post-decrement	post-indexed addressing	<i>*ptr--</i>	use <i>*ptr</i> value, then <b>decrement</b> <i>ptr</i> pointer
Pre-increment	pre-indexed addressing	<i>*++ptr</i>	<b>increment</b> <i>ptr</i> pointer, then use <i>*ptr</i> value
Pre-decrement	pre-indexed addressing	<i>*--ptr</i>	<b>decrement</b> <i>ptr</i> pointer, then use <i>*ptr</i> value

Pre-indexing is marked with an exclamation mark in the ARM assembly language. For example, see line 2 in listing.1.29.

Dennis Ritchie (one of the creators of the C language) mentioned that it presumably was invented by Ken Thompson (another C creator) because this processor feature was present in PDP-7<sup>183</sup>, [Dennis M. Ritchie, *The development of the C language*, (1993)]<sup>184</sup>.

Thus, C language compilers may use it, if it is present on the target processor.

That's very convenient for array processing.

### 1.39.3 Loading a constant into a register

#### 32-bit ARM

As we already know, all instructions have a length of 4 bytes in ARM mode and 2 bytes in Thumb mode.

Then how can we load a 32-bit value into a register, if it's not possible to encode it in one instruction?

Let's try:

```
unsigned int f()
{
    return 0x12345678;
};
```

Listing 1.413: GCC 4.6.3 -O3 ARM mode

```
f:
    ldr    r0, .L2
    bx    lr
.L2:
    .word 305419896 ; 0x12345678
```

So, the 0x12345678 value is just stored aside in memory and loaded if needed.

But it's possible to get rid of the additional memory access.

Listing 1.414: GCC 4.6.3 -O3 -march=armv7-a (ARM mode)

```
movw    r0, #22136    ; 0x5678
movt    r0, #4660     ; 0x1234
bx      lr
```

We see that the value is loaded into the register by parts, the lower part first (using MOVW), then the higher (using MOVT).

This implies that 2 instructions are necessary in ARM mode for loading a 32-bit value into a register.

It's not a real problem, because in fact there are not many constants in real code (except of 0 and 1).

Does it mean that the two-instruction version is slower than one-instruction version?

Doubtfully. Most likely, modern ARM processors are able to detect such sequences and execute them fast.

On the other hand, IDA is able to detect such patterns in the code and disassembles this function as:

```
MOV     R0, 0x12345678
BX      LR
```

<sup>183</sup>[http://yurichev.com/mirrors/C/c\\_dmr\\_postincrement.txt](http://yurichev.com/mirrors/C/c_dmr_postincrement.txt)

<sup>184</sup>Also available as <http://go.yurichev.com/17264>

## ARM64

```
uint64_t f()
{
    return 0x12345678ABCDEF01;
};
```

Listing 1.415: GCC 4.9.1 -O3

```
mov    x0, 61185    ; 0xef01
movk   x0, 0xabcd, lsl 16
movk   x0, 0x5678, lsl 32
movk   x0, 0x1234, lsl 48
ret
```

MOVK stands for “MOV Keep”, i.e., it writes a 16-bit value into the register, not touching the rest of the bits. The LSL suffix shifts left the value by 16, 32 and 48 bits at each step. The shifting is done before loading.

This implies that 4 instructions are necessary to load a 64-bit value into a register.

### Storing floating-point number into register

It's possible to store a floating-point number into a D-register using only one instruction.

For example:

```
double a()
{
    return 1.5;
};
```

Listing 1.416: GCC 4.9.1 -O3 + objdump

```
0000000000000000 <a>:
 0: 1e6f1000    fmov    d0, #1.5000000000000000e+000
 4: d65f03c0    ret
```

The number 1.5 was indeed encoded in a 32-bit instruction. But how?

In ARM64, there are 8 bits in the FMOV instruction for encoding some floating-point numbers.

The algorithm is called VFPEExpandImm() in [ARM Architecture Reference Manual, ARMv8, for ARMv8-A architecture profile, (2013)]<sup>185</sup>. This is also called *minifloat*<sup>186</sup>.

We can try different values: the compiler is able to encode 30.0 and 31.0, but it couldn't encode 32.0, as 8 bytes have to be allocated for this number in the IEEE 754 format:

```
double a()
{
    return 32;
};
```

Listing 1.417: GCC 4.9.1 -O3

```
a:
    ldr    d0, .LC0
    ret
.LC0:
    .word  0
    .word 1077936128
```

<sup>185</sup>Also available as [http://yurichev.com/mirrors/ARMv8-A\\_Architecture\\_Reference\\_Manual\\_\(Issue\\_A.a\).pdf](http://yurichev.com/mirrors/ARMv8-A_Architecture_Reference_Manual_(Issue_A.a).pdf)

<sup>186</sup>[wikipedia](http://wikipedia)

### 1.39.4 Relocs in ARM64

As we know, there are 4-byte instructions in ARM64, so it is impossible to write a large number into a register using a single instruction.

Nevertheless, an executable image can be loaded at any random address in memory, so that's why relocs exists. Read more about them (in relation to Win32 PE): [6.5.2 on page 761](#).

The address is formed using the ADRP and ADD instruction pair in ARM64.

The first loads a 4KiB-page address and the second one adds the remainder. Let's compile the example from "Hello, world!" (listing.1.11) in GCC (Linaro) 4.9 under win32:

Listing 1.418: GCC (Linaro) 4.9 and objdump of object file

```
...>aarch64-linux-gnu-gcc.exe hw.c -c
...>aarch64-linux-gnu-objdump.exe -d hw.o
...
0000000000000000 <main>:
 0: a9bf7bfd      stp    x29, x30, [sp,#-16]!
 4: 910003fd      mov    x29, sp
 8: 90000000      adrp   x0, 0 <main>
 c: 91000000      add    x0, x0, #0x0
10: 94000000      bl     0 <printf>
14: 52800000      mov    w0, #0x0 // #0
18: a8c17bfd      ldp   x29, x30, [sp],#16
1c: d65f03c0      ret

...>aarch64-linux-gnu-objdump.exe -r hw.o
...
RELOCATION RECORDS FOR [.text]:
OFFSET          TYPE          VALUE
0000000000000008 R_AARCH64_ADR_PREL_PG_HI21 .rodata
000000000000000c R_AARCH64_ADD_ABS_LO12_NC  .rodata
0000000000000010 R_AARCH64_CALL26          printf
```

So there are 3 relocs in this object file.

- The first one takes the page address, cuts the lowest 12 bits and writes the remaining high 21 bits to the ADRP instruction's bit fields. This is because we don't need to encode the low 12 bits, and the ADRP instruction has space only for 21 bits.
- The second one puts the 12 bits of the address relative to the page start into the ADD instruction's bit fields.
- The last, 26-bit one, is applied to the instruction at address 0x10 where the jump to the printf() function is.

All ARM64 (and in ARM in ARM mode) instruction addresses have zeros in the two lowest bits (because all instructions have a size of 4 bytes), so one have to encode only the highest 26 bits of 28-bit address space ( $\pm 128\text{MB}$ ).

There are no such relocs in the executable file: because it's known where the "Hello!" string is located, in which page, and the address of puts() is also known.

So there are values set already in the ADRP, ADD and BL instructions (the linker has written them while linking):

Listing 1.419: objdump of executable file

```
0000000000400590 <main>:
400590: a9bf7bfd      stp    x29, x30, [sp,#-16]!
400594: 910003fd      mov    x29, sp
400598: 90000000      adrp   x0, 400000 <_init-0x3b8>
40059c: 91192000      add    x0, x0, #0x648
```

```

4005a0:    97ffffa0    bl    400420 <puts@plt>
4005a4:    52800000    mov   w0, #0x0           // #0
4005a8:    a8c17bfd    ldp   x29, x30, [sp],#16
4005ac:    d65f03c0    ret

```

...

Contents of section .rodata:

```

400640 01000200 00000000 48656c6c 6f210000 .....Hello!..

```

As an example, let's try to disassemble the BL instruction manually.

0x97ffffa0 is 0b100101111111111111111111111111110100000. According to [ARM Architecture Reference Manual, ARMv8, for ARMv8-A architecture profile, (2013)C5.6.26], *imm26* is the last 26 bits:

*imm26* = 0b111111111111111111111111111111110100000. It is 0x3FFFA0, but the MSB is 1, so the number is negative, and we can convert it manually to convenient form for us. By the rules of negation ( 2.2 on page 453), just invert all bits: (it is 0b10111111=0x5F), and add 1 (0x5F+1=0x60). So the number in signed form is -0x60. Let's multiply -0x60 by 4 (because address stored in opcode is divided by 4): it is -0x180. Now let's calculate destination address: 0x4005a0 + (-0x180) = 0x400420 (please note: we consider the address of the BL instruction, not the current value of PC, which may be different!). So the destination address is 0x400420.

More about ARM64-related relocs: [ELF for the ARM 64-bit Architecture (AArch64), (2013)]<sup>187</sup>.

## 1.40 MIPS-specific details

### 1.40.1 Loading a 32-bit constant into register

```

unsigned int f()
{
    return 0x12345678;
};

```

All instructions in MIPS, just like ARM, have a size of 32-bit, so it's not possible to embed a 32-bit constant into one instruction.

So one have to use at least two instructions: the first loads the high part of the 32-bit number and the second one applies an OR operation, which effectively sets the low 16-bit part of the target register:

Listing 1.420: GCC 4.4.5 -O3 (assembly output)

```

li    $2,305397760 # 0x12340000
j     $31
ori   $2,$2,0x5678 ; branch delay slot

```

IDA is fully aware of such frequently encountered code patterns, so, for convenience it shows the last ORI instruction as the LI pseudo instruction, which allegedly loads a full 32-bit number into the \$V0 register.

Listing 1.421: GCC 4.4.5 -O3 (IDA)

```

lui   $v0, 0x1234
jr    $ra
li    $v0, 0x12345678 ; branch delay slot

```

The GCC assembly output has the LI pseudo instruction, but in fact, LUI (“Load Upper Immediate”) is there, which stores a 16-bit value into the high part of the register.

Let's see in *objdump* output:

Listing 1.422: objdump

```

00000000 <f>:
0:    3c021234    lui   v0,0x1234

```

<sup>187</sup>Also available as <http://go.yurichev.com/17288>

```

4: 03e00008    jr    ra
8: 34425678    ori   v0,v0,0x5678

```

## Loading a 32-bit global variable into register

```

unsigned int global_var=0x12345678;

unsigned int f2()
{
    return global_var;
};

```

This is slightly different: LUI loads upper 16-bit from *global\_var* into \$2 (or \$V0) and then LW loads lower 16-bits summing it with the contents of \$2:

Listing 1.423: GCC 4.4.5 -O3 (assembly output)

```

f2:
    lui    $2,%hi(global_var)
    lw     $2,%lo(global_var)($2)
    j     $31
    nop    ; branch delay slot

    ...

global_var:
    .word 305419896

```

IDA is fully aware of often used LUI/LW instruction pair, so it coalesces both into a single LW instruction:

Listing 1.424: GCC 4.4.5 -O3 (IDA)

```

_f2:
    lw     $v0, global_var
    jr    $ra
    or    $at, $zero    ; branch delay slot

    ...

    .data
    .globl global_var
global_var:
    .word 0x12345678    # DATA XREF: _f2

```

*objdump*'s output is the same as GCC's assembly output. Let's also dump relocs of the object file:

Listing 1.425: objdump

```

objdump -D filename.o

...

0000000c <f2>:
   c: 3c020000    lui    v0,0x0
  10: 8c420000    lw     v0,0(v0)
  14: 03e00008    jr    ra
  18: 00200825    move  at,at    ; branch delay slot
 1c: 00200825    move  at,at

Disassembly of section .data:

00000000 <global_var>:
   0: 12345678    beq   s1,s4,159e4 <f2+0x159d8>

...

```

```
objdump -r filename.o
...
RELOCATION RECORDS FOR [.text]:
OFFSET  TYPE          VALUE
0000000c R_MIPS_HI16      global_var
00000010 R_MIPS_L016      global_var
...
```

We can see that address of *global\_var* is to be written right into LUI and LW instructions during executable file loading: high 16-bit part of *global\_var* goes into the first one (LUI), lower 16-bit part goes into the second one (LW).

### 1.40.2 Further reading about MIPS

Dominic Sweetman, *See MIPS Run, Second Edition*, (2010).



# Chapter 2

## Important fundamentals

### 2.1 Integral datatypes

Integral datatype is a type for a value which can be converted to number. These are numbers, enumerations, booleans.

#### 2.1.1 Bit

Obvious usage for bits are boolean values: 0 for *false* and 1 for *true*.

Set of booleans can be packed into **word**: there will be 32 booleans in 32-bit word, etc. This way is called *bitmap* or *bitfield*.

But it has obvious overhead: a bit jiggling, isolating, etc. While using **word** (or *int* type) for boolean variable is not economic, but highly efficient.

In C/C++ environment, 0 is for *false* and any non-zero value is for *true*. For example:

```
if (1234)
    printf ("this will always be executed\n");
else
    printf ("this will never\n");
```

This is popular way of enumerating characters in a C-string:

```
char *input=...;

while(*input) // execute body if *input character is non-zero
{
    // do something with *input
    input++;
};
```

#### 2.1.2 Nibble AKA nybble

**AKA** half-byte, tetrad. Equals to 4 bits.

All these terms are still in use today.

#### Binary-coded decimal (BCD<sup>1</sup>)

4-bit nibbles were used in 4-bit CPUs like legendary Intel 4004 (used in calculators).

It's interesting to know that there was *binary-coded decimal* (BCD) way of representing decimal digit using 4 bits. Decimal 0 is represented as 0b0000, decimal 9 as 0b1001 and higher values are not used. Decimal 1234 is represented as 0x1234. Of course, this way is not economical.

Nevertheless, it has one advantage: decimal to BCD-packed number conversion and back is extremely easy. BCD-numbers can be added, subtracted, etc., but an additional correction is needed. x86 CPUs has

<sup>1</sup>Binary-Coded Decimal

rare instructions for that: AAA/DAA (adjust after addition), AAS/DAS (adjust after subtraction), AAM (after multiplication), AAD (after division).

The need for CPUs to support BCD numbers is a reason why *half-carry flag* (on 8080/Z80) and *auxiliary flag* (AF on x86) are exist: this is carry-flag generated after proceeding of lower 4 bits. The flag is then used for adjustment instructions.

The fact of easy conversion had led to popularity of [Peter Abel, *IBM PC assembly language and programming* (1987)] book. But aside of this book, the author of these notes never seen BCD numbers in practice, except for *magic numbers* ( 5.6.1 on page 714), like when someone's birthday is encoded like 0x19791011—this is indeed packed BCD number.

Surprisingly, the author found a use of BCD-encoded numbers in SAP software: <https://yurichev.com/blog/SAP/>. Some numbers, including prices, are encoded in BCD form in database. Perhaps, they used it to make it compatible with some ancient software/hardware?

BCD instructions in x86 were often used for other purposes, especially in undocumented ways, for example:

```
cmp al,10
sbb al,69h
das
```

This obscure code converts number in 0..15 range into ASCII character '0'..'9', 'A'..'F'.

## Z80

Z80 was clone of 8-bit Intel 8080 CPU, and because of space constraints, it has 4-bit ALU, i.e., each operation over two 8-bit numbers had to be proceeded in two steps. One side-effect of this was easy and natural generation of *half-carry flag*.

### 2.1.3 Byte

Byte is primarily used for character storage. 8-bit bytes were not common as today. Punched tapes for teletypes had 5 and 6 possible holes, this is 5 or 6 bits for byte.

To emphasize the fact the byte has 8 bits, byte is sometimes called *octet*: at least *fetchmail* uses this terminology.

9-bit bytes used to exist in 36-bit architectures: 4 9-bit bytes would fit in a single word. Probably because of this fact, C/C++ standard tells that *char* has to have a room for *at least* 8 bits, but more bits are allowable.

For example, in the early C language manual<sup>2</sup>, we can find this:

```
char one byte character (PDP-11, IBM360: 8 bits; H6070: 9 bits)
```

By H6070 they probably meant Honeywell 6070, with 36-bit words.

### Standard ASCII table

7-bit ASCII table is standard, which has only 128 possible characters. Early E-Mail transport software were operating only on 7-bit ASCII codes, so a MIME<sup>3</sup> standard needed to encode messages in non-Latin writing systems. 7-bit ASCII code was augmented by parity bit, resulting in 8 bits.

*Data Encryption Standard* (DES<sup>4</sup>) has a 56 bits key, this is 8 7-bit bytes, leaving a space to parity bit for each character.

There is no need to memorize whole ASCII table, but rather ranges. [0..0x1F] are control characters (non-printable). [0x20..0x7E] are printable ones. Codes starting at 0x80 are usually used for non-Latin writing systems and/or pseudographics.

<sup>2</sup><https://yurichev.com/mirrors/C/bwk-tutor.html>

<sup>3</sup>Multipurpose Internet Mail Extensions

<sup>4</sup>Data Encryption Standard

Significant codes which will be easily memorized are: 0 (end of C-string, '\0' in C/C++); 0xA or 10 (*line feed*, '\n' in C/C++); 0xD or 13 (*carriage return*, '\r' in C/C++).

0x20 (space) is also often memorized.

## 8-bit CPUs

x86 has capability to work with byte(s) on register level (because they are descendants of 8-bit 8080 CPU), RISC CPUs like ARM and MIPS—not.

### 2.1.4 Wide char

This is an attempt to support multi-lingual environment by extending byte to 16-bit. Most well-known example is Windows NT kernel and win32 functions with *W* suffix. This is why each Latin character in plain English text string is interleaved with zero byte. This encoding is called UCS-2 or UTF-16

Usually, *wchar\_t* is synonym to 16-bit *short* data type.

### 2.1.5 Signed integer vs unsigned

Some may argue, why unsigned data types exist at first place, since any unsigned number can be represented as signed. Yes, but absence of sign bit in a value extends its range twice. Hence, signed byte has range of -128..127, and unsigned one: 0..255. Another benefit of using unsigned data types is self-documenting: you define a variable which can't be assigned to negative values.

Unsigned data types are absent in Java, for which it's criticized. It's hard to implement cryptographical algorithms using boolean operations over signed data types.

Values like 0xFFFFFFFF (-1) are used often, mostly as error codes.

### 2.1.6 Word

**Word** word is somewhat ambiguous term and usually denotes a data type fitting in **GPR**. Bytes are practical for characters, but impractical for other arithmetical calculations.

Hence, many **CPUs** have **GPRs** with width of 16, 32 or 64 bits. Even 8-bit CPUs like 8080 and Z80 offer to work with 8-bit register pairs, each pair forming a 16-bit *pseudoregister* (*BC, DE, HL, etc.*). Z80 has some capability to work with register pairs, and this is, in a sense, some kind of 16-bit CPU emulation.

In general, if a CPU marketed as “n-bit CPU”, this usually means it has n-bit **GPRs**.

There was a time when hard disks and **RAM** modules were marketed as having *n* kilo-words instead of *b* kilobytes/megabytes.

For example, *Apollo Guidance Computer* has 2048 words of **RAM**. This was a 16-bit computer, so there was 4096 bytes of **RAM**.

*TX-0* had 64K of 18-bit words of magnetic core memory, i.e., 64 kilo-words.

*DECSYSTEM-2060* could have up to 4096 kilowords of *solid state memory* (i.e., hard disks, tapes, etc). This was 36-bit computer, so this is 18432 kilobytes or 18 megabytes.

Essentially, why do you need bytes if you have words? Mostly for text strings processing. Words can be used in almost any other situations.

---

*int* in C/C++ is almost always mapped to **word**. (Except of AMD64 architecture where *int* is still 32-bit one, perhaps, for the reason of better portability.)

*int* is 16-bit on PDP-11 and old MS-DOS compilers. *int* is 32-bit on VAX, on x86 starting at 80386, etc.

Even more than that, if type declaration for a variable is omitted in C/C++ program, *int* is used silently by default. Perhaps, this is inheritance of B programming language<sup>5</sup>.

---

**GPR** is usually fastest container for variable, faster than packed bit, and sometimes even faster than byte (because there is no need to isolate a single bit/byte from **GPR**). Even if you use it as a container for loop counter in 0..99 range.

---

<sup>5</sup><http://yurichev.com/blog/typeless/>

---

**Word** in assembly language is still 16-bit for x86, because it was so for 16-bit 8086. *Double word* is 32-bit, *quad word* is 64-bit. That's why 16-bit words are declared using `DW` in x86 assembly, 32-bit ones using `DD` and 64-bit ones using `DQ`.

**Word** is 32-bit for ARM, MIPS, etc., 16-bit data types are called *half-word* there. Hence, *double word* on 32-bit RISC is 64-bit data type.

*GDB* has the following terminology: *halfword* for 16-bit, **word** for 32-bit and *giant word* for 64-bit.

16-bit C/C++ environment on PDP-11 and MS-DOS has *long* data type with width of 32 bits, perhaps, they meant *long word* or *long int*?

32-bit C/C++ environment has *long long* data type with width of 64 bits.

Now you see why the *word* word is ambiguous.

### Should I use *int*?

Some people argue that *int* shouldn't be used at all, because its ambiguity can lead to bugs. For example, well-known *lzbuf* library uses *int* at one point and everything works fine on 16-bit architecture. But if ported to architecture with 32-bit *int*, it can crash: <http://yurichev.com/blog/lzbuf/>.

Less ambiguous types are defined in *stdint.h* file: *uint8\_t*, *uint16\_t*, *uint32\_t*, *uint64\_t*, etc.

Some people like Donald E. Knuth proposed<sup>6</sup> more sonorous words for these types: *byte/wyde/tetra-byte/octabyte*. But these names are less popular than clear terms with inclusion of *u* (*unsigned*) character and number right into the type name.

### Word-oriented computers

Despite the ambiguity of the **word** term, modern computers are still word-oriented: **RAM** and all levels of cache are still organized by words, not by bytes. However, size in bytes is used in marketing.

Access to RAM/cache by address aligned by word boundary is often cheaper than non-aligned.

During data structures development, which are supposed to be fast and efficient, one should always take into consideration length of the **word** on the CPU to be executed on. Sometimes the compiler will do this for programmer, sometimes not.

#### 2.1.7 Address register

For those who fostered on 32-bit and/or 64-bit x86, and/or RISC of 90s like ARM, MIPS, PowerPC, it's natural that address bus has the same width as **GPR** or **word**. Nevertheless, width of address bus can be different on other architectures.

8-bit Z80 can address  $2^{16}$  bytes, using 8-bit registers pairs or dedicated registers (*IX*, *IY*). *SP* and *PC* registers are also 16-bit ones.

Cray-1 supercomputer has 64-bit GPRs, but 24-bit address registers, so it can address  $2^{24}$  (16 megawords or 128 megabytes). RAM was very expensive in 1970s, and a typical Cray had 1048576 (0x100000) words of RAM or 8MB. So why to allocate 64-bit register for address or pointer?

8086/8088 CPUs had a really weird addressing scheme: values of two 16-bit registers were summed in a weird manner resulting in a 20-bit address. Perhaps, this was some kind of toy-level virtualization ( [11.6 on page 1000](#) )? 8086 could run several programs (not simultaneously, though).

Early ARM1 has an interesting artifact:

Another interesting thing about the register file is the PC register is missing a few bits. Since the ARM1 uses 26-bit addresses, the top 6 bits are not used. Because all instructions are aligned on a 32-bit boundary, the bottom two address bits in the PC are always zero. These 8 bits are not only unused, they are omitted from the chip entirely.

( <http://www.righto.com/2015/12/reverse-engineering-arm1-ancestor-of.html> )

Hence, it's physically not possible to push a value with one of two last bits set into PC register. Nor it's possible to set any bits in high 6 bits of PC.

<sup>6</sup><http://www-cs-faculty.stanford.edu/~uno/news98.html>

x86-64 architecture has virtual 64-bit pointers/addresses, but internally, width of address bus is 48 bits (seems enough to address 256TB of [RAM](#)).

## 2.1.8 Numbers

What are numbers used for?

When you see some number(s) altering in a CPU register, you may be interested in what this number means. It's an important skill for a reverse engineer to determine possible data type from a set of changing numbers.

### Boolean

If the number is switching from 0 to 1 and back, most chances that this value has boolean data type.

### Loop counter, array index

Variable increasing from 0, like: 0, 1, 2, 3...—a good chance this is a loop counter and/or array index.

### Signed numbers

If you see a variable which holds very low numbers and sometimes very high numbers, like 0, 1, 2, 3, and 0xFFFFFFFF, 0xFFFFFEE, 0xFFFFFFF, there's a good chance it is a signed variable in *two's complement* form ( [2.2 on the following page](#)), and last 3 numbers are -1, -2, -3.

### 32-bit numbers

There are numbers so large, that there is even a special notation which exists to represent them (Knuth's up-arrow notation). These numbers are so large so these are not practical for engineering, science and mathematics.

Almost all engineers and scientists are happy with IEEE 754 double precision floating point, which has maximal value around  $1.8 \cdot 10^{308}$ . (As a comparison, the number of atoms in the observable universe, is estimated to be between  $4 \cdot 10^{79}$  and  $4 \cdot 10^{81}$ .)

In fact, upper bound in practical computing is much, much lower. In MS-DOS era 16-bit *int* was used almost for everything (array indices, loop counters), while 32-bit *long* was used rarely.

During advent of x86-64, it was decided for *int* to stay as 32 bit size integer, because, probably, usage of 64-bit *int* is even rarer.

I would say, 16-bit numbers in range 0..65535 are probably most used numbers in computing.

Given that, if you see unusually large 32-bit value like 0x87654321, this is a good chance this can be:

- this can still be a 16-bit number, but signed, between 0xFFFF8000 (-32768) and 0xFFFFFFFF (-1).
- address of memory cell (can be checked using memory map feature of debugger).
- packed bytes (can be checked visually).
- bit flags.
- something related to (amateur) cryptography.
- magic number ( [5.6.1 on page 714](#)).
- IEEE 754 floating point number (can also be checked).

Almost same story for 64-bit values.

### ...so 16-bit *int* is enough for almost everything?

It's interesting to note: in [Michael Abrash, *Graphics Programming Black Book*, 1997 chapter 13] we can find that there are plenty cases in which 16-bit variables are just enough. In a meantime, Michael Abrash has a pity that 80386 and 80486 CPUs has so little available registers, so he offers to put two 16-bit values into one 32-bit register and then to rotate it using ROR reg, 16 (on 80386 and later) (ROL reg, 16 will also work) or BSWAP (on 80486 and later) instruction.

That reminds us Z80 with alternate pack of registers (suffixed with apostrophe), to which CPU can switch (and then switch back) using EXX instruction.

### Size of buffer

When a programmer needs to declare the size of some buffer, values in form of  $2^x$  are usually used (512 bytes, 1024, etc.). Values in  $2^x$  form are easily recognizable ( [1.28.5 on page 323](#)) in decimal, hexadecimal and binary base.

But needless to say, programmers are still humans with their decimal culture. And somehow, in **DBMS** area, size of textual database fields is often chosen as  $10^x$  number, like 100, 200. They just think “Okay, 100 is enough, wait, 200 will be better”. And they are right, of course.

Maximum width of **VARCHAR2** data type in Oracle RDBMS is 4000 characters, not 4096.

There is nothing wrong with this, this is just a place where numbers like  $10^x$  can be encountered.

### Address

It's always a good idea to keep in mind an approximate memory map of the process you currently debug. For example, many win32 executables started at 0x00401000, so an address like 0x00451230 is probably located inside executable section. You'll see addresses like these in the EIP register.

Stack is usually located somewhere below.

Many debuggers are able to show the memory map of the debuggee, for example: [1.12.3 on page 80](#).

If a value is increasing by step 4 on 32-bit architecture or by step 8 on 64-bit one, this probably sliding address of some elements of array.

It's important to know that win32 doesn't use addresses below 0x10000, so if you see some number below this constant, this cannot be an address (see also: <https://msdn.microsoft.com/en-us/library/ms810627.aspx>).

Anyway, many debuggers can show you if the value in a register can be an address to something. OllyDbg can also show an ASCII string if the value is an address of it.

### Bit field

If you see a value where one (or more) bit(s) are flipping from time to time like 0xABCD1234 → 0xABCD1434 and back, this is probably a bit field (or bitmap).

### Packed bytes

When *strcpy()* or *memcpy()* copies a buffer, it loads/stores 4 (or 8) bytes simultaneously, so if a string containing “4321”, and it would be copied to another place, at one point you'll see 0x31323334 value in some register. This is 4 packed bytes into a 32-bit value.

## 2.2 Signed number representations

There are several methods for representing signed numbers, but “two's complement” is the most popular one in computers.

Here is a table for some byte values:

binary	hexadecimal	unsigned	signed
01111111	0x7f	127	127
01111110	0x7e	126	126
...			
00000110	0x6	6	6
00000101	0x5	5	5
00000100	0x4	4	4
00000011	0x3	3	3
00000010	0x2	2	2
00000001	0x1	1	1
00000000	0x0	0	0
11111111	0xff	255	-1
11111110	0xfe	254	-2
11111101	0xfd	253	-3
11111100	0xfc	252	-4
11111011	0xfb	251	-5
11111010	0xfa	250	-6
...			
10000010	0x82	130	-126
10000001	0x81	129	-127
10000000	0x80	128	-128

The difference between signed and unsigned numbers is that if we represent 0xFFFFFFFF and 0x00000002 as unsigned, then the first number (4294967294) is bigger than the second one (2). If we represent them both as signed, the first one becomes -2, and it is smaller than the second (2). That is the reason why conditional jumps ( 1.18 on page 124) are present both for signed (e.g. JG, JL) and unsigned (JA, JB) operations.

For the sake of simplicity, this is what one needs to know:

- Numbers can be signed or unsigned.
- C/C++ signed types:
  - `int64_t` (-9,223,372,036,854,775,808 .. 9,223,372,036,854,775,807) (- 9.2.. 9.2 quintillions) or 0x8000000000000000..0x7FFFFFFFFFFFFFFF),
  - `int` (-2,147,483,648..2,147,483,647 (- 2.15.. 2.15Gb) or 0x80000000..0x7FFFFFFF),
  - `char` (-128..127 or 0x80..0x7F),
  - `ssize_t`.

Unsigned:

- `uint64_t` (0..18,446,744,073,709,551,615 ( 18 quintillions) or 0..0xFFFFFFFFFFFFFFFF),
- `unsigned int` (0..4,294,967,295 ( 4.3Gb) or 0..0xFFFFFFFF),
- `unsigned char` (0..255 or 0..0xFF),
- `size_t`.
- Signed types have the sign in the **MSB**: 1 means “minus”, 0 means “plus”.
- Promoting to a larger data types is simple: 1.34.5 on page 404.
- Negation is simple: just invert all bits and add 1.

We can keep in mind that a number of inverse sign is located on the opposite side at the same proximity from zero. The addition of one is needed because zero is present in the middle.

- The addition and subtraction operations work well for both signed and unsigned values. But for multiplication and division operations, x86 has different instructions: IDIV/IMUL for signed and DIV/MUL for unsigned.
- Here are some more instructions that work with signed numbers: CBW/CWD/CWDE/CDQ/CDQE ( .1.6 on page 1032), MOVSB ( 1.23.1 on page 201), SAR ( .1.6 on page 1036).

A table of some negative and positive values ( ?? on page ??) looks like thermometer with Celsius scale. This is why addition and subtraction works equally well for both signed and unsigned numbers: if the first addend is represented as mark on thermometer, and one need to add a second addend, and it's positive,

we just shift mark up on thermometer by the value of second addend. If the second addend is negative, then we shift mark down to absolute value of the second addend.

Addition of two negative numbers works as follows. For example, we need to add -2 and -3 using 16-bit registers. -2 and -3 is 0xfffe and 0xfffd respectively. If we add these numbers as unsigned, we will get 0xfffe+0xfffd=0x1fffb. But we work on 16-bit registers, so the result is *cut off*, the first 1 is dropped, 0xfffb is left, and this is -5. This works because -2 (or 0xfffe) can be represented using plain English like this: “2 lacks in this value up to maximal value in 16-bit register + 1”. -3 can be represented as “...3 lacks in this value up to ...”. Maximal value of 16-bit register + 1 is 0x10000. During addition of two numbers and *cutting off* by  $2^{16}$  modulo,  $2 + 3 = 5$  will be lacking.

## 2.2.1 Using IMUL over MUL

Example like listing.3.23.2 where two unsigned values are multiplied compiles into listing.3.23.2 where IMUL is used instead of MUL.

This is important property of both MUL and IMUL instructions. First of all, they both produce 64-bit value if two 32-bit values are multiplied, or 128-bit value if two 64-bit values are multiplied (biggest possible **product** in 32-bit environment is

0xffffffff\*0xffffffff=0xffffffe00000001). But C/C++ standards have no way to access higher half of result, and a **product** always has the same size as multiplicands. And both MUL and IMUL instructions works in the same way if higher half is ignored, i.e., they both generate the same lower half. This is important property of “two’s complement” way of representing signed numbers.

So C/C++ compiler can use any of these instructions.

But IMUL is more versatile than MUL because it can take any register(s) as source, while MUL requires one of multiplicands stored in AX/EAX/RAX register. Even more than that: MUL stores result in EDX:EAX pair in 32-bit environment, or RDX:RAX in 64-bit one, so it always calculates the whole result. On contrary, it’s possible to set a single destination register while using IMUL instead of pair, and then CPU will calculate only lower half, which works faster [see Torborn Granlund, *Instruction latencies and throughput for AMD and Intel x86 processors*<sup>7</sup>).

Given than, C/C++ compilers may generate IMUL instruction more often than MUL.

Nevertheless, using compiler intrinsic, it’s still possible to do unsigned multiplication and get *full* result. This is sometimes called *extended multiplication*. MSVC has intrinsic for this called `__emul`<sup>8</sup> and another one: `_umul128`<sup>9</sup>. GCC offer `__int128` data type, and if 64-bit multiplicands are first promoted to 128-bit ones, then a **product** is stored into another `__int128` value, then result is shifted by 64 bits right, you’ll get higher half of result<sup>10</sup>.

## MulDiv() function in Windows

Windows has MulDiv() function<sup>11</sup>, fused multiply/divide function, it multiplies two 32-bit integers into intermediate 64-bit value and then divides it by a third 32-bit integer. It is easier than to use two compiler intrinsic, so Microsoft developers made a special function for it. And it seems, this is busy function, judging by its usage.

## 2.2.2 Couple of additions about two’s complement form

Exercise 2-1. Write a program to determine the ranges of char, short, int, and long variables, both signed and unsigned, by printing appropriate values from standard headers and by direct computation.

---

Brian W. Kernighan, Dennis M. Ritchie, *The C Programming Language*, 2ed, (1988)

---

<sup>7</sup><http://yurichev.com/mirrors/x86-timing.pdf>

<sup>8</sup>[https://msdn.microsoft.com/en-us/library/d2s81xt0\(v=vs.80\).aspx](https://msdn.microsoft.com/en-us/library/d2s81xt0(v=vs.80).aspx)

<sup>9</sup><https://msdn.microsoft.com/library/3daytw9%28v=vs.100%29.aspx>

<sup>10</sup>Example: <http://stackoverflow.com/a/13187798>

<sup>11</sup>[https://msdn.microsoft.com/en-us/library/windows/desktop/aa383718\(v=vs.85\).aspx](https://msdn.microsoft.com/en-us/library/windows/desktop/aa383718(v=vs.85).aspx)



## Getting maximum number of some word

Maximum unsigned number is just a number where all bits are set:  $0xFF\dots FF$  (this is -1 if the word is treated as signed integer). So you take a word, set all bits and get the value:

```
#include <stdio.h>

int main()
{
    unsigned int val=~0; // change to "unsigned char" to get maximal value for the unsigned
    8-bit byte
    // 0-1 will also work, or just -1
    printf ("%u\n", val); // ;
}
```

This is 4294967295 for 32-bit integer.

## Getting minimum number for some signed word

Minimum signed number is encoded as  $0x80\dots 00$ , i.e., most significant bit is set, while others are cleared. Maximum signed number is encoded in the same way, but all bits are inverted:  $0x7F\dots FF$ .

Let's shift a lone bit left until it disappears:

```
#include <stdio.h>

int main()
{
    signed int val=1; // change to "signed char" to find values for signed byte
    while (val!=0)
    {
        printf ("%d %d\n", val, ~val);
        val=val<<1;
    };
};
```

Output is:

```
...
536870912 -536870913
1073741824 -1073741825
-2147483648 2147483647
```

Two last numbers are minimum and maximum signed 32-bit *int* respectively.

### 2.2.3 -1

Now you see that -1 is when all bits are set. Often, you can find the -1 constant in all sorts of code, where a constant with all bits set are needed, for example, a mask.

For example: [3.18.1 on page 530](#).

## 2.3 Integer overflow

I intentionally put this section after the section about signed number representation.

First, take a look at this implementation of *itoa()* function from [Brian W. Kernighan, Dennis M. Ritchie, *The C Programming Language*, 2ed, (1988)]:

```
void itoa(int n, char s[])
{
    int i, sign;
    if ((sign = n) < 0) /* record sign */
        n = -n; /* make n positive */
    i = 0;
    do { /* generate digits in reverse order */
        s[i++] = n % 10 + '0'; /* get next digit */
    } while ((n /= 10) > 0); /* delete it */
    if (sign < 0)
        s[i++] = '-';
    s[i] = '\0';
    strrev(s);
}
```

( The full source code: [https://beginners.re/current-tree/fundamentals/itoa\\_KR.c](https://beginners.re/current-tree/fundamentals/itoa_KR.c) )

It has a subtle bug. Try to find it. You can download source code, compile it, etc. The answer on the next page.

From [Brian W. Kernighan, Dennis M. Ritchie, *The C Programming Language*, 2ed, (1988)]:

Exercise 3-4. In a two's complement number representation, our version of *itoa* does not handle the largest negative number, that is, the value of  $n$  equal to  $-(2^{\text{wordsize}-1})$ . Explain why not. Modify it to print that value correctly, regardless of the machine on which it runs.

The answer is: the function cannot process largest negative number (INT\_MIN or 0x80000000 or -2147483648) correctly.

How to change sign? Invert all bits and add 1. If to invert all bits in INT\_MIN value (0x80000000), this is 0x7fffffff. Add 1 and this is 0x80000000 again. So changing sign has no effect. This is an important artifact of two's complement system.

Further reading:

- blexim - Basic Integer Overflows<sup>12</sup>
- Yannick Moy, Nikolaj Bjørner, and David Sielaff - Modular Bug-finding for Integer Overflows in the Large: Sound, Efficient, Bit-precise Static Analysis<sup>13</sup>

## 2.4 AND

### 2.4.1 Checking if a value is on $2^n$ boundary

If you need to check if your value is divisible by  $2^n$  number (like 1024, 4096, etc.) without remainder, you can use a % operator in C/C++, but there is a simpler way. 4096 is 0x1000, so it always has  $4 \times 3 = 12$  lower bits cleared.

What you need is just:

```
if (value&0xFFF)
{
    printf ("value is not divisible by 0x1000 (or 4096)\n");
    printf ("by the way, remainder is %d\n", value&0xFFF);
}
else
    printf ("value is divisible by 0x1000 (or 4096)\n");
```

In other words, this code checks if there are any bit set among lower 12 bits. As a side effect, lower 12 bits is always a remainder from division a value by 4096 (because division by  $2^n$  is merely a right shift, and shifted (and dropped) bits are bits of remainder).

Same story if you want to check if the number is odd or even:

```
if (value&1)
    // odd
else
    // even
```

This is merely the same as if to divide by 2 and get 1-bit remainder.

### 2.4.2 KOI-8R Cyrillic encoding

It was a time when 8-bit ASCII table wasn't supported by some Internet services, including email. Some supported, some others—not.

It was also a time, when non-Latin writing systems used second half of 8-bit ASCII table to accommodate non-Latin characters. There were several popular Cyrillic encodings, but KOI-8R (devised by Andrey "ache" Chernov) is somewhat unique in comparison with others.

<sup>12</sup><http://phrack.org/issues/60/10.html>

<sup>13</sup><https://yurichev.com/mirrors/SMT/z3prefix.pdf>

	0	1	2	3	4	5	6	7	8	9	A	B	C	D	E	F
0																
1																
2	!	"	#	\$	%	&	'	(	)	*	+	,	-	.	/	
3	0	1	2	3	4	5	6	7	8	9	:	;	<	=	>	?
4	@	A	B	C	D	E	F	G	H	I	J	K	L	M	N	O
5	P	Q	R	S	T	U	V	W	X	Y	Z	[	\	]	^	_
6	`	a	b	c	d	e	f	g	h	i	j	k	l	m	n	o
7	p	q	r	s	t	u	v	w	x	y	z	{		}	~	
8	-															
9																
A	=															
B																
C	ю	а	б	ц	г	е	ф	г	х	и	й	к	л	м	н	о
D	п	я	р	с	т	у	ж	в	ь	ы	з	ш	э	щ	ч	ъ
E	ю	а	б	ц	д	е	ф	г	х	и	й	к	л	м	н	о
F	п	я	р	с	т	у	ж	в	ь	ы	з	ш	э	щ	ч	ъ

Figure 2.1: KOI8-R table

Someone may notice that Cyrillic characters are allocated almost in the same sequence as Latin ones. This leads to one important property: if all 8th bits in Cyrillic text encoded in KOI-8R are to be reset, a text transforms into transliterated text with Latin characters in place of Cyrillic. For example, Russian sentence:

Мой дядя самых честных правил, Когда не в шутку занемог, Он уважать себя заставил, И лучше выдумать не мог.

...if encoded in KOI-8R and then 8th bit stripped, transforms into:

mOJ DQDQ SAMYH ^ESTNYH PRAWIL, KOGDA NE W [UTKU ZANEMOG, oN UWAVATX SEBQ ZASTAWIL, i LU^[E WYDUMATX NE MOG.

...perhaps this is not very appealing aesthetically, but this text is still readable to Russian language natives. Hence, Cyrillic text encoded in KOI-8R, passed through an old 7-bit service will survive into transliterated, but still readable text.

Stripping 8th bit is automatically transposes any character from the second half of the (any) 8-bit ASCII table to the first one, into the same place (take a look at red arrow right of table). If the character has already been placed in the first half (i.e., it has been in standard 7-bit ASCII table), it's not transposed.

Perhaps, transliterated text is still recoverable, if you'll add 8th bit to the characters which were seems transliterated.

Drawback is obvious: Cyrillic characters allocated in KOI-8R table are not in the same sequence as in Russian/Bulgarian/Ukrainian/etc. alphabet, and this isn't suitable for sorting, for example.

## 2.5 AND and OR as subtraction and addition

### 2.5.1 ZX Spectrum ROM text strings

Those who once investigated ZX Spectrum ROM internals, probably noticed that the last symbol of each text string is seemingly absent.

```

~(.....6.....i ..0.NEXT
without FO.Variable not
foun.Subscript wron.Out
of memor.Out of scree.N
umber too bi.RETURN with
out GOSU.End of fil.STOP
statemen.Invalid argume
n.Integer out of rang.No
nsense in BASI.BREAK - C
ONT repeat.Out of DAT.In
valid file nam.No room f
or lin.STOP in INPU.FOR
without NEX.Invalid I/O
devic.Invalid colou.BREA
K into progra.RAMTOP no
goo.Statement los.Invali
d strea.FN without DE.Pa
rameter erro.Tape loadin
g erro.,.. 1982 Sinclair
Research Lt.>.....CI

```

Figure 2.2: Part of ZX Spectrum ROM

There are present, in fact.

Here is excerpt of ZX Spectrum 128K ROM disassembled:

```

L048C:  DEFM "MERGE erro"          ; Report 'a'.
        DEFB 'r'+$80
L0497:  DEFM "Wrong file typ"     ; Report 'b'.
        DEFB 'e'+$80
L04A6:  DEFM "CODE erro"         ; Report 'c'.
        DEFB 'r'+$80
L04B0:  DEFM "Too many bracket"   ; Report 'd'.
        DEFB 's'+$80
L04C1:  DEFM "File already exist" ; Report 'e'.
        DEFB 's'+$80

```

( [http://www.matthew-wilson.net/spectrum/rom/128\\_ROM0.html](http://www.matthew-wilson.net/spectrum/rom/128_ROM0.html) )

Last character has most significant bit set, which marks string end. Presumably, it was done to save some space? Old 8-bit computers have very tight environment.

Characters of all messages are always in standard 7-bit [ASCII](#) table, so it's guaranteed 7th bit is never used for characters.

To print such string, we must check [MSB](#) of each byte, and if it's set, we must clear it, then print character, and then stop. Here is a C example:

```

unsigned char hw[]=
{
    'H',
    'e',
    'l',
    'l',
    'o'|0x80
};

void print_string()
{
    for (int i=0; ;i++)
    {
        if (hw[i]&0x80) // check MSB
        {
            // clear MSB
            // (in other words, clear all, but leave 7 lower bits intact)
            printf ("%c", hw[i] & 0x7F);

```

```

                // stop
                break;
            };
            printf ("%c", hw[i]);
        };
};

```

Now what is interesting, since 7th bit is the most significant bit (in byte), we can check it, set it and remove it using arithmetical operations instead of logical.

I can rewrite my C example:

```

unsigned char hw[]=
{
    'H',
    'e',
    'l',
    'l',
    'o'+0x80
};

void print()
{
    for (int i=0; ;i++)
    {
        // hw[] must have 'unsigned char' type
        if (hw[i] >= 0x80) // check for MSB
        {
            printf ("%c", hw[i]-0x80); // clear MSB
            // stop
            break;
        };
        printf ("%c", hw[i]);
    };
};

```

By default, *char* is signed type in C/C++, so to compare it with variable like 0x80 (which is negative (-128) if treated as signed), we must treat each character in text message as unsigned.

Now if 7th bit is set, the number is always larger or equal to 0x80. If 7th bit is clear, the number is always smaller than 0x80.

Even more than that: if 7th bit is set, it can be cleared by subtracting 0x80, nothing else. If it's not set beforehand, however, subtracting will destruct other bits.

Likewise, if 7th bit is clear, it's possible to set it by adding 0x80. But if it's set beforehand, addition operation will destruct some other bits.

In fact, this is valid for any bit. If the 4th bit is clear, you can set it just by adding 0x10: 0x100+0x10 = 0x110. If the 4th bit is set, you can clear it by subtracting 0x10: 0x1234-0x10 = 0x1224.

It works, because carry isn't happened during addition/subtraction. It will, however, happen, if the bit is already set there before addition, or absent before subtraction.

Likewise, addition/subtraction can be replaced using OR/AND operation if two conditions are met: 1) you want to add/subtract by a number in form of  $2^n$ ; 2) this bit in source value is clear/set.

For example, addition of 0x20 is the same as ORing value with 0x20 under condition that this bit is clear before: 0x1204|0x20 = 0x1204+0x20 = 0x1224.

Subtraction of 0x20 is the same as ANDing value with 0x20 (0x....FFDF), but if this bit is set before: 0x1234&(~0x20) = 0x1234&0xFFDF = 0x1234-0x20 = 0x1214.

Again, it works because carry not happened when you add  $2^n$  number and this bit isn't set before.

This property of boolean algebra is important, worth understanding and keeping it in mind.

Another example in this book: [3.19.3 on page 540](#).

## 2.6 XOR (exclusive OR)

XOR is widely used when one needs just to flip specific bit(s). Indeed, the XOR operation applied with 1 effectively inverts a bit:

input A	input B	output
0	0	0
0	1	1
1	0	1
1	1	0

And vice-versa, the XOR operation applied with 0 does nothing, i.e., it's an idle operation. This is a very important property of the XOR operation and it's highly recommended to memorize it.

### 2.6.1 Logical difference

In Cray-1 supercomputer (1976-1977) manual <sup>14</sup>, you can find XOR instruction was called *logical difference*.

Indeed,  $XOR(a,b)=1$  if  $a \neq b$ .

### 2.6.2 Everyday speech

XOR operation present in common everyday speech. When someone asks "please buy apples or bananas", this usually means "buy the first object or the second, but not both"—this is exactly exclusive OR, because logical OR would mean "both objects are also fine".

Some people suggest "and/or" should be used in everyday speech to make emphasis that logical OR is used instead of exclusive OR: <https://en.wikipedia.org/wiki/And/or>.

### 2.6.3 Encryption

XOR is heavily used in both amateur ( 9.1 on page 922) and *real* encryption (at least in *Feistel network*).

XOR is very useful here because:  $cipher\_text = plain\_text \oplus key$  and then:  $(plain\_text \oplus key) \oplus key = plain\_text$ .

### 2.6.4 RAID4

RAID4 offers a very simple method to protect hard disks. For example, there are several disks ( $D_1, D_2, D_3$ , etc.) and one parity disk ( $P$ ). Each bit/byte written to parity disk is calculated and written on-fly:

$$P = D_1 \oplus D_2 \oplus D_3 \quad (2.1)$$

If any of disks is failed, for example,  $D_2$ , it's restored using the very same way:

$$D_2 = D_1 \oplus P \oplus D_3 \quad (2.2)$$

If parity disk failed, it is restored using 2.1 way. If two of any disks are failed, then it wouldn't be possible to restore both.

RAID5 is more advanced, but this XOR property is still exploited there.

That's why RAID controllers has hardware "XOR accelerators" helping to XOR large chunks of written data on-fly. When computers get faster and faster, it now can be done at software level, using SIMD.

### 2.6.5 XOR swap algorithm

Hard to believe, but this code swaps values in EAX and EBX without aid of any other additional register or memory cell:

<sup>14</sup>[http://www.bitsavers.org/pdf/cray/CRAY-1/HR-0004-CRAY\\_1\\_Hardware\\_Reference\\_Manual-PRELIMINARY-1975.OCR.pdf](http://www.bitsavers.org/pdf/cray/CRAY-1/HR-0004-CRAY_1_Hardware_Reference_Manual-PRELIMINARY-1975.OCR.pdf)

```
xor eax, ebx
xor ebx, eax
xor eax, ebx
```

Let's find out, how it works. First, we will rewrite it to step aside from x86 assembly language:

```
X = X XOR Y
Y = Y XOR X
X = X XOR Y
```

What X and Y has at each step? Just keep in mind the simple rule:  $(X \oplus Y) \oplus Y = X$  for any values of X and Y.

Let's see, X after 1st step has  $X \oplus Y$ ; Y after 2nd step has  $Y \oplus (X \oplus Y) = X$ ; X after 3rd step has  $(X \oplus Y) \oplus X = Y$ . Hard to say if anyone should use this trick, but it serves as a good demonstration example of XOR properties.

Wikipedia article ([https://en.wikipedia.org/wiki/XOR\\_swap\\_algorithm](https://en.wikipedia.org/wiki/XOR_swap_algorithm)) has also yet another explanation: addition and subtraction operations can be used instead of XOR:

```
X = X + Y
Y = X - Y
X = X - Y
```

Let's see: X after 1st step has  $X + Y$ ; Y after 2nd step has  $X + Y - Y = X$ ; X after 3rd step has  $X + Y - X = Y$ .

## 2.6.6 XOR linked list

Doubly linked list is a list in which each element has link to the previous element and to the next one. Hence, it's very easy to traverse list backwards or forward. `std::list` in C++ implements doubly linked list which also is examined in this book: [3.21.4 on page 570](#).

So each element has two pointers. Is it possible, perhaps in environment of small RAM footprint, to preserve all functionality with one pointer instead of two? Yes, if a value of  $prev \oplus next$  will be stored in this memory cell, which is usually called "link".

Maybe, we could say that address to the previous element is "encrypted" using address of next element and otherwise: next element address is "encrypted" using previous element address.

When we traverse this list forward, we always know address of the previous element, so we can "decrypt" this field and get address of the next element. Likewise, it's possible to traverse this list backwards, "decrypting" this field using next element's address.

But it's not possible to find address of previous or next element of some specific element without knowing address of the first one.

Couple of things to complete this solution: first element will have address of next element without any XOR-ing, last element will have address of previous element without any XOR-ing.

Now let's sum it up. This is example of doubly linked list of 5 elements.  $A_x$  is address of element.

address	link field contents
$A_0$	$A_1$
$A_1$	$A_0 \oplus A_2$
$A_2$	$A_1 \oplus A_3$
$A_3$	$A_2 \oplus A_4$
$A_4$	$A_3$

And again, hard to say if anyone should use this tricky hacks, but this is also a good demonstration of XOR properties. As with XOR swap algorithm, Wikipedia article about it also offers way to use addition or subtraction instead of XOR: [https://en.wikipedia.org/wiki/XOR\\_linked\\_list](https://en.wikipedia.org/wiki/XOR_linked_list).



## 2.6.7 Switching value trick

... found in Jorg Arndt — Matters Computational / Ideas, Algorithms, Source Code <sup>15</sup>.

You want a variable to be switching between 123 and 456. You may write something like:

```
if (a==123)
    a=456;
else
    a=123;
```

But this can be done using a single operation:

```
#include <stdio.h>

int main()
{
    int a=123;
#define C 123^456

    a=a^C;
    printf ("%d\n", a);
    a=a^C;
    printf ("%d\n", a);
    a=a^C;
    printf ("%d\n", a);
};
```

It works because  $123 \oplus 123 \oplus 456 = 0 \oplus 456 = 456$  and  $456 \oplus 123 \oplus 456 = 456 \oplus 456 \oplus 123 = 0 \oplus 123 = 123$ .

One can argue, worth it using or not, especially keeping in mind code readability. But this is yet another demonstration of XOR properties.

## 2.6.8 Zobrist hashing / tabulation hashing

If you work on a chess engine, you traverse a game tree many times per second, and often, you can encounter the same position, which has already been processed.

So you have to use a method to store already calculated positions somewhere. But chess position can require a lot of memory, and a hash function would be used instead.

Here is a way to compress a chess position into 64-bit value, called Zobrist hashing:

```
// we have 8*8 board and 12 pieces (6 for white side and 6 for black)
uint64_t table[12][8][8]; // filled with random values
int position[8][8]; // for each square on board. 0 - no piece. 1..12 - piece
uint64_t hash;

for (int row=0; row<8; row++)
    for (int col=0; col<8; col++)
    {
        int piece=position[row][col];

        if (piece!=0)
            hash=hash^table[piece][row][col];
    };

return hash;
```

Now the most interesting part: if the next (modified) chess position differs only by one (moved) piece, you don't need to recalculate hash for the whole position, all you need is:

<sup>15</sup><https://www.jjj.de/fxt/fxtbook.pdf>

```
hash=...; // (already calculated)

// subtract information about the old piece:
hash=hash^table[old_piece][old_row][old_col];

// add information about the new piece:
hash=hash^table[new_piece][new_row][new_col];
```

## 2.6.9 By the way

The usual *OR* also sometimes called *inclusive OR* (or even *IOR*), as opposed to *exclusive OR*. One place is *operator* Python's library: it's called *operator.ior* here.

## 2.6.10 AND/OR/XOR as MOV

*OR reg, 0xFFFFFFFF* sets all bits to 1, hence, no matter what has been in register before, it will be set to -1. *OR reg, -1* is shorter than *MOV reg, -1*, so MSVC uses *OR* instead the latter, for example: [3.18.1 on page 530](#).

Likewise, *AND reg, 0* always resets all bits, hence, it acts like *MOV reg, 0*.

*XOR reg, reg*, no matter what has been in register beforehand, resets all bits, and also acts like *MOV reg, 0*.

## 2.7 Population count

*POPCNT* instruction is population count (AKA Hamming weight). It just counts number of bits set in an input value.

As a side effect, *POPCNT* instruction (or operation) can be used to determine, if the value has  $2^n$  form. Since,  $2^n$  number always has just one single bit, *POPCNT*'s result will always be just 1.

For example, I once wrote a base64 strings scanner for hunting something interesting in binary files<sup>16</sup>. And there is a lot of garbage and false positives, so I add an option to filter out data blocks which has size of  $2^n$  bytes (i.e., 256 bytes, 512, 1024, etc.). The size of block is checked just like this:

```
if (popcnt(size)==1)
    // OK
...
```

The instruction is also known as “[NSA<sup>17</sup>](#) instruction” due to rumors:

This branch of cryptography is fast-paced and very politically charged. Most designs are secret; a majority of military encryptions systems in use today are based on LFSRs. In fact, most Cray computers (Cray 1, Cray X-MP, Cray Y-MP) have a rather curious instruction generally known as “population count.” It counts the 1 bits in a register and can be used both to efficiently calculate the Hamming distance between two binary words and to implement a vectorized version of a LFSR. I've heard this called the canonical NSA instruction, demanded by almost all computer contracts.

[Bruce Schneier, *Applied Cryptography*, (John Wiley & Sons, 1994)]

## 2.8 Endianness

The endianness is a way of representing values in memory.

<sup>16</sup><https://github.com/DennisYurichev/base64scanner>

<sup>17</sup>National Security Agency

## 2.8.1 Big-endian

The 0x12345678 value is represented in memory as:

address in memory	byte value
+0	0x12
+1	0x34
+2	0x56
+3	0x78

Big-endian CPUs include Motorola 68k, IBM POWER.

## 2.8.2 Little-endian

The 0x12345678 value is represented in memory as:

address in memory	byte value
+0	0x78
+1	0x56
+2	0x34
+3	0x12

Little-endian CPUs include Intel x86. One important example of little-endian using in this book is: ?? on page ??.

## 2.8.3 Example

Let's take big-endian MIPS Linux installed and ready in QEMU <sup>18</sup>.

And let's compile this simple example:

```
#include <stdio.h>

int main()
{
    int v;

    v=123;

    printf ("%02X %02X %02X %02X\n",
            *(char*)&v,
            (((char*)&v)+1),
            (((char*)&v)+2),
            (((char*)&v)+3));
};
```

After running it we get:

```
root@debian-mips:~# ./a.out
00 00 00 7B
```

That is it. 0x7B is 123 in decimal. In little-endian architectures, 7B is the first byte (you can check on x86 or x86-64), but here it is the last one, because the highest byte goes first.

That's why there are separate Linux distributions for MIPS ("mips" (big-endian) and "mipsel" (little-endian)). It is impossible for a binary compiled for one endianness to work on an OS with different endianness.

There is another example of MIPS big-endiannes in this book: 1.30.4 on page 365.

## 2.8.4 Bi-endian

CPUs that may switch between endianness are ARM, PowerPC, SPARC, MIPS, IA64<sup>19</sup>, etc.

<sup>18</sup>Available for download here: <http://go.yurichev.com/17008>

<sup>19</sup>Intel Architecture 64 (Itanium)

## 2.8.5 Converting data

The BSWAP instruction can be used for conversion.

TCP/IP network data packets use the big-endian conventions, so that is why a program working on a little-endian architecture has to convert the values. The `htonl()` and `htons()` functions are usually used.

In TCP/IP, big-endian is also called “network byte order”, while byte order on the computer “host byte order”. “host byte order” is little-endian on Intel x86 and other little-endian architectures, but it is big-endian on IBM POWER, so `htonl()` and `htons()` don’t shuffle any bytes on the latter.

## 2.9 Memory

There are 3 main types of memory:

- Global memory **AKA** “static memory allocation”. No need to allocate explicitly, the allocation is performed just by declaring variables/arrays globally. These are global variables, residing in the data or constant segments. They are available globally (hence, considered as an **anti-pattern**). Not convenient for buffers/arrays, because they must have a fixed size. Buffer overflows that occur here usually overwrite variables or buffers residing next to them in memory. There’s an example in this book: [1.12.3 on page 77](#).
- Stack **AKA** “allocate on stack”. The allocation is performed just by declaring variables/arrays locally in the function. These are usually local variables for the function. Sometimes these local variable are also available to descending functions (to **callee** functions, if caller passes a pointer to a variable to the **callee** to be executed). Allocation and deallocation are very fast, it just **SP** needs to be shifted.

But they’re also not convenient for buffers/arrays, because the buffer size has to be fixed, unless `alloca()` ([1.9.2 on page 35](#)) (or a variable-length array) is used. Buffer overflows usually overwrite important stack structures: [1.26.2 on page 273](#).

- Heap **AKA** “dynamic memory allocation”. Allocation/deallocation is performed by calling `malloc()/free()` or `new/delete` in C++. This is the most convenient method: the block size may be set at runtime.

Resizing is possible (using `realloc()`), but can be slow. This is the slowest way to allocate memory: the memory allocator must support and update all control structures while allocating and deallocating. Buffer overflows usually overwrite these structures. Heap allocations are also source of memory leak problems: each memory block has to be deallocated explicitly, but one may forget about it, or do it incorrectly.

Another problem is the “use after free”—using a memory block after `free()` has been called on it, which is very dangerous.

Example in this book: [1.30.2 on page 348](#).

## 2.10 CPU

### 2.10.1 Branch predictors

Some latest compilers try to get rid of conditional jump instructions. Examples in this book are: [1.18.1 on page 135](#), [1.18.3 on page 143](#), [1.28.5 on page 331](#).

This is because the branch predictor is not always perfect, so the compilers try to do without conditional jumps, if possible.

Conditional instructions in ARM (like `ADRcc`) are one way, another one is the `CMOVcc` x86 instruction.

### 2.10.2 Data dependencies

Modern CPUs are able to execute instructions simultaneously (**OOE<sup>20</sup>**), but in order to do so, the results of one instruction in a group must not influence the execution of others. Hence, the compiler endeavors to use instructions with minimal influence on the CPU state.

That’s why the `LEA` instruction is so popular, because it does not modify CPU flags, while other arithmetic instructions does.

---

<sup>20</sup>Out-of-Order Execution

## 2.11 Hash functions

A very simple example is CRC32, an algorithm that provides “stronger” checksum for integrity checking purposes. It is impossible to restore the original text from the hash value, it has much less information: But CRC32 is not cryptographically secure: it is known how to alter a text in a way that the resulting CRC32 hash value will be the one we need. Cryptographic hash functions are protected from this.

MD5, SHA1, etc. are such functions and they are widely used to hash user passwords in order to store them in a database. Indeed: an Internet forum database may not contain user passwords (a stolen database can compromise all users’ passwords) but only hashes (so a cracker can’t reveal the passwords). Besides, an Internet forum engine does not need to know your password exactly, it needs only to check if its hash is the same as the one in the database, and give you access if they match. One of the simplest password cracking methods is just to try hashing all possible passwords in order to see which matches the resulting value that we need. Other methods are much more complex.

### 2.11.1 How do one-way functions work?

A one-way function is a function which is able to transform one value into another, while it is impossible (or very hard) to reverse it. Some people have difficulties while understanding how this is possible at all. Here is a simple demonstration.

We have a vector of 10 numbers in range 0..9, each is present only once, for example:

```
4 6 0 1 3 5 7 8 9 2
```

The algorithm for the simplest possible one-way function is:

- take the number at zeroth position (4 in our case);
- take the number at first position (6 in our case);
- swap numbers at positions of 4 and 6.

Let’s mark the numbers at positions 4 and 6:

```
4 6 0 1 3 5 7 8 9 2
      ^  ^
```

Let’s swap them and we get this result:

```
4 6 0 1 7 5 3 8 9 2
```

While looking at the result, and even if we know the algorithm, we can’t know unambiguously the initial state, because the first two numbers could be 0 and/or 1, and then they could participate in the swapping procedure.

This is an utterly simplified example for demonstration. Real one-way functions are much more complex.

## Chapter 3

# Slightly more advanced examples

### 3.1 Zero register

x86 architecture lacks zero register, unlike MIPS and ARM. However, it's often a case, when a compiler assigns a zero to a register, that will hold it upon the function's exit.

This is a case of Mahjong game from Windows 7 x86. Zeroed EBX (at 0x010281BF) is used to initialize local variables, to pass zero argument into other functions and to compare values against it.

Listing 3.1: Mahjong.exe from Windows 7 x86

```
.text:010281AE sub_10281AE    proc near                ; CODE XREF: sub_1028790+4FFp
.text:010281AE                                ; sub_102909A+357p ...
.text:010281AE
.text:010281AE var_34      = dword ptr -34h
.text:010281AE var_30      = dword ptr -30h
.text:010281AE var_2C      = dword ptr -2Ch
.text:010281AE var_28      = dword ptr -28h
.text:010281AE var_24      = dword ptr -24h
.text:010281AE var_20      = dword ptr -20h
.text:010281AE var_1C      = dword ptr -1Ch
.text:010281AE var_18      = dword ptr -18h
.text:010281AE var_14      = dword ptr -14h
.text:010281AE var_10      = dword ptr -10h
.text:010281AE var_4       = dword ptr -4
.text:010281AE arg_0       = dword ptr 8
.text:010281AE arg_4       = byte ptr 0Ch
.text:010281AE
.text:010281AE          push    28h
.text:010281B0          mov     eax, offset __ehandler$?
    ↙ enable_segment@_Helper@_Concurrent_vector_base_v4@details@Concurrency@@SAIAAV234@II@Z
.text:010281B5          call   __EH_prolog3
.text:010281BA          mov     edi, ecx
.text:010281BC          mov     esi, [ebp+arg_0]
.text:010281BF          xor     ebx, ebx                ; *
.text:010281C1          mov     [ebp+var_10], ebx      ; *
.text:010281C4          cmp     [esi], ebx            ; *
.text:010281C6          jbe    short loc_10281E8
.text:010281C8
.text:010281C8 loc_10281C8:                ; CODE XREF: sub_10281AE+38j
.text:010281C8          mov     eax, [esi+0Ch]
.text:010281CB          mov     ecx, [ebp+var_10]
.text:010281CE          push   dword ptr [eax+ecx*4]
.text:010281D1          call   sub_10506C9
.text:010281D6          mov     eax, [ebp+var_10]
.text:010281D9          pop     ecx
.text:010281DA          mov     ecx, [esi+0Ch]
.text:010281DD          mov     [ecx+eax*4], ebx      ; *
.text:010281E0          inc     eax
.text:010281E1          mov     [ebp+var_10], eax
.text:010281E4          cmp     eax, [esi]
.text:010281E6          jnb    short loc_10281C8
.text:010281E8
```

```

.text:010281E8 loc_10281E8: ; CODE XREF: sub_10281AE+18j
.text:010281E8 mov [esi], ebx ; *
.text:010281EA mov [edi+14h], ebx ; *
.text:010281ED mov [ebp+var_34], ebx ; *
.text:010281F0 mov [ebp+var_30], ebx ; *
.text:010281F3 mov [ebp+var_2C], 10h
.text:010281FA mov [ebp+var_28], ebx ; *
.text:010281FD mov [ebp+var_4], ebx ; *
.text:01028200 mov [ebp+arg_0], ebx ; *
.text:01028203 cmp [edi+0B0h], ebx ; *
.text:01028209 jbe loc_10282C3
.text:0102820F
.text:0102820F loc_102820F: ; CODE XREF: sub_10281AE+10Fj
.text:0102820F mov eax, [edi+0BCh]
.text:01028215 mov ecx, [ebp+arg_0]
.text:01028218 mov eax, [eax+ecx*4]
.text:0102821B mov [ebp+var_14], eax
.text:0102821E cmp eax, ebx ; *
.text:01028220 jz loc_10282A6
.text:01028226 push ebx ; *
.text:01028227 push eax
.text:01028228 mov ecx, edi
.text:0102822A call sub_1026B3D
.text:0102822F test al, al
.text:01028231 jz short loc_10282A6
.text:01028233 mov [ebp+var_24], ebx ; *
.text:01028236 mov [ebp+var_20], ebx ; *
.text:01028239 mov [ebp+var_1C], 10h
.text:01028240 mov [ebp+var_18], ebx ; *
.text:01028243 lea eax, [ebp+var_34]
.text:01028246 push eax
.text:01028247 lea eax, [ebp+var_24]
.text:0102824A push eax
.text:0102824B push [ebp+var_14]
.text:0102824E mov ecx, edi
.text:01028250 mov byte ptr [ebp+var_4], 1
.text:01028254 call sub_1026E4F
.text:01028259 mov [ebp+var_10], ebx ; *
.text:0102825C cmp [ebp+var_24], ebx ; *
.text:0102825F jbe short loc_102829B
.text:01028261
.text:01028261 loc_1028261: ; CODE XREF: sub_10281AE+EBj
.text:01028261 push 0Ch ; Size
.text:01028263 call sub_102E741
.text:01028268 pop ecx
.text:01028269 cmp eax, ebx ; *
.text:0102826B jz short loc_1028286
.text:0102826D mov edx, [ebp+var_10]
.text:01028270 mov ecx, [ebp+var_18]
.text:01028273 mov ecx, [ecx+edx*4]
.text:01028276 mov edx, [ebp+var_14]
.text:01028279 mov edx, [edx+4]
.text:0102827C mov [eax], edx
.text:0102827E mov [eax+4], ecx
.text:01028281 mov [eax+8], ebx ; *
.text:01028284 jmp short loc_1028288
.text:01028286 ; -----
.text:01028286
.text:01028286 loc_1028286: ; CODE XREF: sub_10281AE+BDj
.text:01028286 xor eax, eax
.text:01028288
.text:01028288 loc_1028288: ; CODE XREF: sub_10281AE+D6j
.text:01028288 push eax
.text:01028289 mov ecx, esi
.text:0102828B call sub_104922B
.text:01028290 inc [ebp+var_10]
.text:01028293 mov eax, [ebp+var_10]
.text:01028296 cmp eax, [ebp+var_24]
.text:01028299 jb short loc_1028261
.text:0102829B

```

```

.text:0102829B loc_102829B:                ; CODE XREF: sub_10281AE+B1j
.text:0102829B      lea    ecx, [ebp+var_24]
.text:0102829E      mov    byte ptr [ebp+var_4], bl
.text:010282A1      call  sub_10349DB
.text:010282A6      loc_10282A6:                ; CODE XREF: sub_10281AE+72j
.text:010282A6      ; sub_10281AE+83j
.text:010282A6      push  [ebp+arg_0]
.text:010282A9      lea    ecx, [ebp+var_34]
.text:010282AC      call  sub_104922B
.text:010282B1      inc    [ebp+arg_0]
.text:010282B4      mov    eax, [ebp+arg_0]
.text:010282B7      cmp    eax, [edi+0B0h]
.text:010282BD      jb    loc_102820F
.text:010282C3      loc_10282C3:                ; CODE XREF: sub_10281AE+5Bj
.text:010282C3      cmp    [ebp+arg_4], bl
.text:010282C6      jz    short loc_1028337
.text:010282C8      mov    eax, dword_1088AD8
.text:010282CD      mov    esi, ds:EnableMenuItem
.text:010282D3      mov    edi, 40002
.text:010282D8      cmp    [eax+8], ebx        ; *
.text:010282DB      jnz  short loc_10282EC
.text:010282DD      push  3                    ; uEnable
.text:010282DF      push  edi                  ; uIDEnableItem
.text:010282E0      push  hMenu                ; hMenu
.text:010282E6      call  esi ; EnableMenuItem
.text:010282E8      push  3
.text:010282EA      jmp   short loc_10282F7
.text:010282EC ; -----
.text:010282EC      loc_10282EC:                ; CODE XREF: sub_10281AE+12Dj
.text:010282EC      push  ebx                  ; *
.text:010282ED      push  edi                  ; uIDEnableItem
.text:010282EE      push  hMenu                ; hMenu
.text:010282F4      call  esi ; EnableMenuItem
.text:010282F6      push  ebx                  ; *
.text:010282F7      loc_10282F7:                ; CODE XREF: sub_10281AE+13Cj
.text:010282F7      push  edi                  ; uIDEnableItem
.text:010282F8      push  hmenu                ; hMenu
.text:010282FE      call  esi ; EnableMenuItem
.text:01028300      mov    ecx, dword_1088AD8
.text:01028306      call  sub_1020402
.text:0102830B      mov    edi, 40001
.text:01028310      test   al, al
.text:01028312      jz    short loc_1028321
.text:01028314      push  ebx                  ; *
.text:01028315      push  edi                  ; uIDEnableItem
.text:01028316      push  hMenu                ; hMenu
.text:0102831C      call  esi ; EnableMenuItem
.text:0102831E      push  ebx                  ; *
.text:0102831F      jmp   short loc_102832E
.text:01028321 ; -----
.text:01028321      loc_1028321:                ; CODE XREF: sub_10281AE+164j
.text:01028321      push  3                    ; uEnable
.text:01028323      push  edi                  ; uIDEnableItem
.text:01028324      push  hMenu                ; hMenu
.text:0102832A      call  esi ; EnableMenuItem
.text:0102832C      push  3                    ; uEnable
.text:0102832E      loc_102832E:                ; CODE XREF: sub_10281AE+171j
.text:0102832E      push  edi                  ; uIDEnableItem
.text:0102832F      push  hmenu                ; hMenu
.text:01028335      call  esi ; EnableMenuItem
.text:01028337      loc_1028337:                ; CODE XREF: sub_10281AE+118j
.text:01028337      lea    ecx, [ebp+var_34]
.text:0102833A      call  sub_10349DB

```



```
.text:0102833F          call    ___EH_epilog3
.text:01028344          retn   8
.text:01028344 sub_10281AE endp
```

By the way, IDA can rename a register inside a function (press n):

Listing 3.2: Mahjong.exe from Windows 7 x86

```
.text:010281AE sub_10281AE  proc near
...
.text:010281AE zero = ebx
...
.text:010281BF          xor    zero, zero           ; *
.text:010281C1          mov    [ebp+var_10], zero   ; *
.text:010281C4          cmp    [esi], zero         ; *
.text:010281C6          jbe   short loc_10281E8
...

```

## 3.2 Double negation

A popular way<sup>1</sup> to convert non-zero value into 1 (or boolean *true*) and zero value into 0 (or boolean *false*) is `!!statement`:

```
int convert_to_bool(int a)
{
    return !!a;
};
```

Optimizing GCC 5.4 x86:

```
convert_to_bool:
    mov     edx, DWORD PTR [esp+4]
    xor     eax, eax
    test   edx, edx
    setne  al
    ret
```

XOR always clears return value in EAX, even in case if SETNE will not trigger. I.e., XOR sets default return value to zero.

If the input value is not equal to zero (-NE suffix in SET instruction), 1 is set to AL, otherwise AL isn't touched.

Why SETNE operates on low 8-bit part of EAX register? Because the matter is just in the last bit (0 or 1), while other bits are cleared by XOR.

Therefore, that C/C++ code could be rewritten like this:

```
int convert_to_bool(int a)
{
    if (a!=0)
        return 1;
    else
        return 0;
};
```

<sup>1</sup>This way is also controversial, because it leads to hard-to-read code

...or even:

```
int convert_to_bool(int a)
{
    if (a)
        return 1;
    else
        return 0;
};
```

Compilers targeting CPUs lacking instruction similar to SET, in this case, generates branching instructions, etc.

### 3.3 const correctness

This is undeservedly underused feature of many programming languages. Read here about its importance: [1](#), [2](#).

Ideally, everything you don't modify should have *const* modifier.

Interestingly, how *const correctness* is implemented at low level. There are no runtime checks of local *const* variables and function arguments (only compile-time checks). But global variables of such a type are to be allocated in read-only data segments.

This is example is to be crashed, because if compiled by MSVC for win32, the *a* global variable is allocated in `.rdata` read-only segment:

```
const a=123;

void f(int *i)
{
    *i=11; // crash
};

int main()
{
    f(&a);
    return a;
};
```

*Anonymous* (not linked to a variable name) C strings also have `const char*` type. You can't modify them:

```
#include <string.h>
#include <stdio.h>

void alter_string(char *s)
{
    strcpy (s, "Goodbye!");
    printf ("Result: %s\n", s);
};

int main()
{
    alter_string ("Hello, world!\n");
};
```

This code will crash on Linux ("segmentation fault") and on Windows if compiled by MinGW.

GCC for Linux places all text strings info `.rodata` data segment, which is explicitly read-only ("read only data"):

```
$ objdump -s 1

...

Contents of section .rodata:
400600 01000200 52657375 6c743a20 25730a00  ....Result: %s..
400610 48656c6c 6f2c2077 6f726c64 210a00    Hello, world!..
```

When the `alter_string()` function tries to write there, exception occurred.

Things are different in the code generated by MSVC, strings are located in `.data` segment, which has no `READONLY` flag. MSVC's developers misstep?

```
C:\...>objdump -s 1.exe

...

Contents of section .data:
40b000 476f6f64 62796521 00000000 52657375  Goodbye!...Resu
40b010 6c743a20 25730a00 48656c6c 6f2c2077  lt: %s..Hello, w
40b020 6f726c64 210a0000 00000000 00000000  orld!.....
40b030 01000000 00000000 c0cb4000 00000000  .....@.....

...

C:\...>objdump -x 1.exe

...

Sections:
Idx Name          Size      VMA           LMA           File off  Algn
  0 .text          00006d2a  00401000     00401000     00000400  2**2
CONTENTS, ALLOC, LOAD, READONLY, CODE
  1 .rdata         00002262  00408000     00408000     00007200  2**2
CONTENTS, ALLOC, LOAD, READONLY, DATA
  2 .data          00000e00  0040b000     0040b000     00009600  2**2
CONTENTS, ALLOC, LOAD, DATA
  3 .reloc         00000b98  0040e000     0040e000     0000a400  2**2
CONTENTS, ALLOC, LOAD, READONLY, DATA
```

However, MinGW hasn't this fault and allocates text strings in `.rdata` segment.

### 3.3.1 Overlapping const strings

The fact that an *anonymous* C-string has *const* type ([1.5.1 on page 9](#)), and that C-strings allocated in constants segment are guaranteed to be immutable, has an interesting consequence: the compiler may use a specific part of the string.

Let's try this example:

```
#include <stdio.h>

int f1()
{
    printf ("world\n");
}

int f2()
{
    printf ("hello world\n");
}

int main()
{
    f1();
    f2();
}
```

Common C/C++-compilers (including MSVC) allocate two strings, but let's see what GCC 4.8.1 does:

Listing 3.3: GCC 4.8.1 + IDA listing

```
f1          proc near
s           = dword ptr -1Ch
           sub     esp, 1Ch
```

```

        mov     [esp+1Ch+s], offset s ; "world\n"
        call   _puts
        add    esp, 1Ch
        retn
f1      endp

f2      proc near

s       = dword ptr -1Ch

        sub    esp, 1Ch
        mov    [esp+1Ch+s], offset aHello ; "hello "
        call   _puts
        add    esp, 1Ch
        retn
f2      endp

aHello  db 'hello '
s       db 'world',0xa,0

```

Indeed: when we print the “hello world” string these two words are positioned in memory adjacently and `puts()` called from `f2()` function is not aware that this string is divided. In fact, it’s not divided; it’s divided only *virtually*, in this listing.

When `puts()` is called from `f1()`, it uses the “world” string plus a zero byte. `puts()` is not aware that there is something before this string!

This clever trick is often used by at least GCC and can save some memory. This is close to *string interning*.

Another related example is here: [3.4](#).

## 3.4 strstr() example

Let’s back to the fact that GCC sometimes can use part of string: [3.3.1 on the previous page](#).

The `strstr()` C/C++ standard library function is used to find any occurrence in a string. This is what we will do:

```

#include <string.h>
#include <stdio.h>

int main()
{
    char *s="Hello, world!";
    char *w=strstr(s, "world");

    printf ("%p, [%s]\n", s, s);
    printf ("%p, [%s]\n", w, w);
};

```

The output is:

```

0x8048530, [Hello, world!]
0x8048537, [world!]

```

The difference between the address of the original string and the address of the substring that `strstr()` has returned is 7. Indeed, “Hello, ” string has length of 7 characters.

The `printf()` function during second call has no idea there are some other characters before the passed string and it prints characters from the middle of original string till the end (marked by zero byte).

## 3.5 qsort() revisited

(Let’s back to the fact that `CMP` instruction works like `SUB`: [1.12.4 on page 87](#).)

Now that you already familiar with `qsort()` function ( [1.33 on page 384](#)), here is a nice example where comparison operation (CMP) can be replaced by subtraction operation (SUB).

```
/* qsort int comparison function */
int int_cmp(const void *a, const void *b)
{
    const int *ia = (const int *)a; // casting pointer types
    const int *ib = (const int *)b;
    return *ia - *ib;
    /* integer comparison: returns negative if b > a
    and positive if a > b */
}
```

( [http://www.anyexample.com/programming/c/qsort\\_\\_sorting\\_array\\_of\\_strings\\_\\_integers\\_and\\_structs.xml](http://www.anyexample.com/programming/c/qsort__sorting_array_of_strings__integers_and_structs.xml) <http://archive.is/Hh3jz> )

Also, a typical implementation of `strcmp()` (from OpenBSD):

```
int
strcmp(const char *s1, const char *s2)
{
    while (*s1 == *s2++)
        if (*s1++ == 0)
            return (0);
    return (*(unsigned char *)s1 - *(unsigned char *)--s2);
}
```

## 3.6 Temperature converting

Another very popular example in programming books for beginners is a small program that converts Fahrenheit temperature to Celsius or back.

$$C = \frac{5 \cdot (F - 32)}{9}$$

We can also add simple error handling: 1) we must check if the user has entered a correct number; 2) we must check if the Celsius temperature is not below  $-273$  (which is below absolute zero, as we may recall from school physics lessons).

The `exit()` function terminates the program instantly, without returning to the [caller](#) function.

### 3.6.1 Integer values

```
#include <stdio.h>
#include <stdlib.h>

int main()
{
    int celsius, fahr;
    printf ("Enter temperature in Fahrenheit:\n");
    if (scanf ("%d", &fahr)!=1)
    {
        printf ("Error while parsing your input\n");
        exit(0);
    };

    celsius = 5 * (fahr-32) / 9;

    if (celsius<-273)
    {
        printf ("Error: incorrect temperature!\n");
        exit(0);
    };
    printf ("Celsius: %d\n", celsius);
}
```

```
};
```

## Optimizing MSVC 2012 x86

Listing 3.4: Optimizing MSVC 2012 x86

```
$SG4228 DB 'Enter temperature in Fahrenheit:', 0aH, 00H
$SG4230 DB '%d', 00H
$SG4231 DB 'Error while parsing your input', 0aH, 00H
$SG4233 DB 'Error: incorrect temperature!', 0aH, 00H
$SG4234 DB 'Celsius: %d', 0aH, 00H

_fahr$ = -4 ; size = 4
_main PROC
    push    ecx
    push    esi
    mov     esi, DWORD PTR __imp__printf
    push    OFFSET $SG4228 ; 'Enter temperature in Fahrenheit:'
    call    esi ; call printf()
    lea    eax, DWORD PTR _fahr$[esp+12]
    push    eax
    push    OFFSET $SG4230 ; '%d'
    call    DWORD PTR __imp__scanf
    add    esp, 12
    cmp    eax, 1
    je     SHORT $LN2@main
    push    OFFSET $SG4231 ; 'Error while parsing your input'
    call    esi ; call printf()
    add    esp, 4
    push    0
    call    DWORD PTR __imp__exit
$LN9@main:
$LN2@main:
    mov     eax, DWORD PTR _fahr$[esp+8]
    add    eax, -32 ; ffffffff0H
    lea    ecx, DWORD PTR [eax+eax*4]
    mov     eax, 954437177 ; 38e38e39H
    imul   ecx
    sar    edx, 1
    mov     eax, edx
    shr    eax, 31 ; 0000001fH
    add    eax, edx
    cmp    eax, -273 ; fffffeeFH
    jge    SHORT $LN1@main
    push    OFFSET $SG4233 ; 'Error: incorrect temperature!'
    call    esi ; call printf()
    add    esp, 4
    push    0
    call    DWORD PTR __imp__exit
$LN10@main:
$LN1@main:
    push    eax
    push    OFFSET $SG4234 ; 'Celsius: %d'
    call    esi ; call printf()
    add    esp, 8
    ; return 0 - by C99 standard
    xor    eax, eax
    pop    esi
    pop    ecx
    ret    0
$LN8@main:
_main ENDP
```

What we can say about it:

- The address of `printf()` is first loaded in the ESI register, so the subsequent `printf()` calls are done just by the `CALL ESI` instruction. It's a very popular compiler technique, possible if several consequent calls to the same function are present in the code, and/or if there is a free register which can be used for this.

- We see the `ADD EAX, -32` instruction at the place where 32 has to be subtracted from the value.  $EAX = EAX + (-32)$  is equivalent to  $EAX = EAX - 32$  and somehow, the compiler decided to use `ADD` instead of `SUB`. Maybe it's worth it, it's hard to be sure.
- The `LEA` instruction is used when the value is to be multiplied by 5: `lea ecx, DWORD PTR [eax+eax*4]`. Yes,  $i + i * 4$  is equivalent to  $i * 5$  and `LEA` works faster than `IMUL`. By the way, the `SHL EAX, 2 / ADD EAX, EAX` instruction pair could be also used here instead—some compilers do it like.
- The division by multiplication trick ([3.12 on page 500](#)) is also used here.
- `main()` returns 0 if we don't have `return 0` at its end. The C99 standard tells us [*ISO/IEC 9899:TC3 (C99 standard)*, (2007)5.1.2.2.3] that `main()` will return 0 in case the `return` statement is missing. This rule works only for the `main()` function.  
Though, `MSVC` doesn't officially support C99, but maybe it support it partially?

## Optimizing MSVC 2012 x64

The code is almost the same, but we can find `INT 3` instructions after each `exit()` call.

```
xor    ecx, ecx
call   QWORD PTR __imp_exit
int    3
```

`INT 3` is a debugger breakpoint.

It is known that `exit()` is one of the functions which can never return <sup>2</sup>, so if it does, something really odd has happened and it's time to load the debugger.

## 3.6.2 Floating-point values

```
#include <stdio.h>
#include <stdlib.h>

int main()
{
    double celsius, fahr;
    printf ("Enter temperature in Fahrenheit:\n");
    if (scanf ("%lf", &fahr)!=1)
    {
        printf ("Error while parsing your input\n");
        exit(0);
    };

    celsius = 5 * (fahr-32) / 9;

    if (celsius<-273)
    {
        printf ("Error: incorrect temperature!\n");
        exit(0);
    };
    printf ("Celsius: %lf\n", celsius);
};
```

`MSVC 2010 x86` uses `FPU` instructions...

Listing 3.5: Optimizing `MSVC 2010 x86`

```
$SG4038 DB    'Enter temperature in Fahrenheit:', 0aH, 00H
$SG4040 DB    '%lf', 00H
$SG4041 DB    'Error while parsing your input', 0aH, 00H
$SG4043 DB    'Error: incorrect temperature!', 0aH, 00H
$SG4044 DB    'Celsius: %lf', 0aH, 00H

__real@0711000000000000 DQ 0c07110000000000r    ; -273
__real@4022000000000000 DQ 0402200000000000r    ; 9
```

<sup>2</sup>another popular one is `longjmp()`

```

__real@4014000000000000 DQ 0401400000000000r ; 5
__real@4040000000000000 DQ 0404000000000000r ; 32

_fahr$ = -8 ; size = 8
_main PROC
    sub     esp, 8
    push   esi
    mov     esi, DWORD PTR __imp__printf
    push   OFFSET $SG4038 ; 'Enter temperature in Fahrenheit:'
    call   esi ; call printf()
    lea    eax, DWORD PTR _fahr$[esp+16]
    push   eax
    push   OFFSET $SG4040 ; '%lf'
    call   DWORD PTR __imp__scanf
    add    esp, 12
    cmp    eax, 1
    je     SHORT $LN2@main
    push   OFFSET $SG4041 ; 'Error while parsing your input'
    call   esi ; call printf()
    add    esp, 4
    push   0
    call   DWORD PTR __imp__exit
$LN2@main:
    fld    QWORD PTR _fahr$[esp+12]
    fsub   QWORD PTR __real@4040000000000000 ; 32
    fmul   QWORD PTR __real@4014000000000000 ; 5
    fdiv   QWORD PTR __real@4022000000000000 ; 9
    fld    QWORD PTR __real@c071100000000000 ; -273
    fcomp  ST(1)
    fnstsw ax
    test   ah, 65 ; 00000041H
    jne   SHORT $LN1@main
    push   OFFSET $SG4043 ; 'Error: incorrect temperature!'
    fstp  ST(0)
    call   esi ; call printf()
    add    esp, 4
    push   0
    call   DWORD PTR __imp__exit
$LN1@main:
    sub    esp, 8
    fstp  QWORD PTR [esp]
    push   OFFSET $SG4044 ; 'Celsius: %lf'
    call   esi
    add    esp, 12
    ; return 0 - by C99 standard
    xor    eax, eax
    pop    esi
    add    esp, 8
    ret    0
$LN10@main:
_main   ENDP

```

...but MSVC 2012 uses [SIMD](#) instructions instead:

Listing 3.6: Optimizing MSVC 2010 x86

```

$SG4228 DB 'Enter temperature in Fahrenheit:', 0aH, 00H
$SG4230 DB '%lf', 00H
$SG4231 DB 'Error while parsing your input', 0aH, 00H
$SG4233 DB 'Error: incorrect temperature!', 0aH, 00H
$SG4234 DB 'Celsius: %lf', 0aH, 00H
__real@c071100000000000 DQ 0c07110000000000r ; -273
__real@4040000000000000 DQ 0404000000000000r ; 32
__real@4022000000000000 DQ 0402200000000000r ; 9
__real@4014000000000000 DQ 0401400000000000r ; 5

_fahr$ = -8 ; size = 8
_main PROC
    sub     esp, 8
    push   esi
    mov     esi, DWORD PTR __imp__printf

```



```

    push    OFFSET $SG4228          ; 'Enter temperature in Fahrenheit:'
    call   esi                      ; call printf()
    lea   eax, DWORD PTR _fahr$[esp+16]
    push  eax
    push  OFFSET $SG4230          ; '%lf'
    call  DWORD PTR __imp__scanf
    add   esp, 12
    cmp   eax, 1
    je    SHORT $LN2@main
    push  OFFSET $SG4231          ; 'Error while parsing your input'
    call  esi                      ; call printf()
    add   esp, 4
    push  0
    call  DWORD PTR __imp__exit
$LN9@main:
$LN2@main:
    movsd  xmm1, QWORD PTR _fahr$[esp+12]
    subsd  xmm1, QWORD PTR __real@4040000000000000 ; 32
    movsd  xmm0, QWORD PTR __real@c071100000000000 ; -273
    mulsd  xmm1, QWORD PTR __real@4014000000000000 ; 5
    divsd  xmm1, QWORD PTR __real@4022000000000000 ; 9
    comisd xmm0, xmm1
    jbe    SHORT $LN1@main
    push  OFFSET $SG4233          ; 'Error: incorrect temperature!'
    call  esi                      ; call printf()
    add   esp, 4
    push  0
    call  DWORD PTR __imp__exit
$LN10@main:
$LN1@main:
    sub    esp, 8
    movsd  QWORD PTR [esp], xmm1
    push  OFFSET $SG4234          ; 'Celsius: %lf'
    call  esi                      ; call printf()
    add   esp, 12
    ; return 0 - by C99 standard
    xor   eax, eax
    pop   esi
    add   esp, 8
    ret   0
$LN8@main:
_main   ENDP

```

Of course, [SIMD](#) instructions are available in x86 mode, including those working with floating point numbers.

It's somewhat easier to use them for calculations, so the new Microsoft compiler uses them.

We can also see that the `-273` value is loaded into `XMM0` register too early. And that's OK, because the compiler may emit instructions not in the order they are in the source code.

## 3.7 Fibonacci numbers

Another widespread example used in programming textbooks is a recursive function that generates the Fibonacci numbers<sup>3</sup>. The sequence is very simple: each consecutive number is the sum of the previous two. The first two numbers are 0 and 1, or 1 and 1.

The sequence starts like this:

0, 1, 1, 2, 3, 5, 8, 13, 21, 34, 55, 89, 144, 233, 377, 610, 987, 1597, 2584, 4181...

### 3.7.1 Example #1

The implementation is simple. This program generates the sequence until 21.

```
#include <stdio.h>
```

<sup>3</sup><http://go.yurichev.com/17332>

```

void fib (int a, int b, int limit)
{
    printf ("%d\n", a+b);
    if (a+b > limit)
        return;
    fib (b, a+b, limit);
};

int main()
{
    printf ("0\n1\n1\n");
    fib (1, 1, 20);
};

```

Listing 3.7: MSVC 2010 x86

```

_a$ = 8           ; size = 4
_b$ = 12         ; size = 4
_limit$ = 16     ; size = 4
_fib PROC
    push    ebp
    mov     ebp, esp
    mov     eax, DWORD PTR _a$[ebp]
    add     eax, DWORD PTR _b$[ebp]
    push    eax
    push    OFFSET $SG2643
    call   DWORD PTR __imp__printf
    add     esp, 8
    mov     ecx, DWORD PTR _a$[ebp]
    add     ecx, DWORD PTR _b$[ebp]
    cmp     ecx, DWORD PTR _limit$[ebp]
    jle    SHORT $LN1@fib
    jmp     SHORT $LN2@fib
$LN1@fib:
    mov     edx, DWORD PTR _limit$[ebp]
    push    edx
    mov     eax, DWORD PTR _a$[ebp]
    add     eax, DWORD PTR _b$[ebp]
    push    eax
    mov     ecx, DWORD PTR _b$[ebp]
    push    ecx
    call   _fib
    add     esp, 12
$LN2@fib:
    pop     ebp
    ret     0
_fib ENDP

_main PROC
    push    ebp
    mov     ebp, esp
    push    OFFSET $SG2647 ; "0\n1\n1\n"
    call   DWORD PTR __imp__printf
    add     esp, 4
    push    20
    push    1
    push    1
    call   _fib
    add     esp, 12
    xor     eax, eax
    pop     ebp
    ret     0
_main ENDP

```

We will illustrate the stack frames with this.

Let's load the example in OllyDbg and trace to the last call of f():

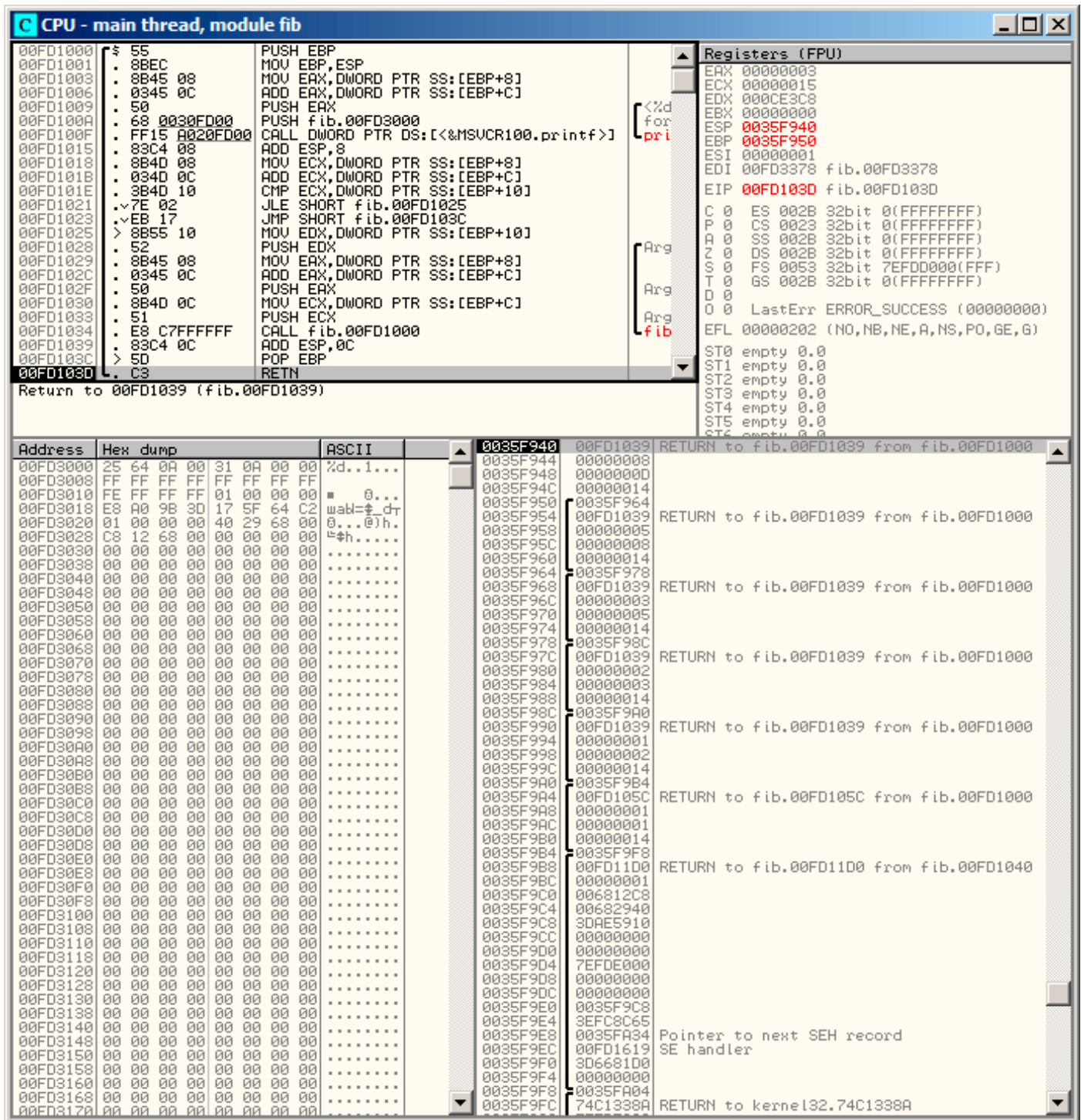

Figure 3.1: OllyDbg: last call of f()

Let's investigate the stack more closely. Comments were added by the author of this book <sup>4</sup>:

```
0035F940 00FD1039 RETURN to fib.00FD1039 from fib.00FD1000
0035F944 00000008 1st argument: a
0035F948 0000000D 2nd argument b
0035F94C 00000014 3rd argument: limit
0035F950 /0035F964 saved EBP register
0035F954 |00FD1039 RETURN to fib.00FD1039 from fib.00FD1000
0035F958 |00000005 1st argument: a
0035F95C |00000008 2nd argument: b
0035F960 |00000014 3rd argument: limit
0035F964 ]0035F978 saved EBP register
0035F968 |00FD1039 RETURN to fib.00FD1039 from fib.00FD1000
0035F96C |00000003 1st argument: a
0035F970 |00000005 2nd argument: b
0035F974 |00000014 3rd argument: limit
0035F978 ]0035F98C saved EBP register
0035F97C |00FD1039 RETURN to fib.00FD1039 from fib.00FD1000
0035F980 |00000002 1st argument: a
0035F984 |00000003 2nd argument: b
0035F988 |00000014 3rd argument: limit
0035F98C ]0035F9A0 saved EBP register
0035F990 |00FD1039 RETURN to fib.00FD1039 from fib.00FD1000
0035F994 |00000001 1st argument: a
0035F998 |00000002 2nd argument: b
0035F99C |00000014 3rd argument: limit
0035F9A0 ]0035F9B4 saved EBP register
0035F9A4 |00FD105C RETURN to fib.00FD105C from fib.00FD1000
0035F9A8 |00000001 1st argument: a \
0035F9AC |00000001 2nd argument: b | prepared in main() for f1()
0035F9B0 |00000014 3rd argument: limit /
0035F9B4 ]0035F9F8 saved EBP register
0035F9B8 |00FD11D0 RETURN to fib.00FD11D0 from fib.00FD1040
0035F9BC |00000001 main() 1st argument: argc \
0035F9C0 |006812C8 main() 2nd argument: argv | prepared in CRT for main()
0035F9C4 |00682940 main() 3rd argument: envp /
```

The function is recursive <sup>5</sup>, hence stack looks like a “sandwich”.

We see that the *limit* argument is always the same (0x14 or 20), but the *a* and *b* arguments are different for each call.

There are also the *RA*-s and the saved EBP values. OllyDbg is able to determine the EBP-based frames, so it draws these brackets. The values inside each bracket make the *stack frame*, in other words, the stack area which each function incarnation uses as scratch space.

We can also say that each function incarnation must not access stack elements beyond the boundaries of its frame (excluding function arguments), although it's technically possible.

It's usually true, unless the function has bugs.

Each saved EBP value is the address of the previous *stack frame*: this is the reason why some debuggers can easily divide the stack in frames and dump each function's arguments.

As we see here, each function incarnation prepares the arguments for the next function call.

At the end we see the 3 arguments for `main()`. `argc` is 1 (yes, indeed, we have ran the program without command-line arguments).

This easily to lead to a stack overflow: just remove (or comment out) the limit check and it will crash with exception 0xC00000FD (stack overflow.)

### 3.7.2 Example #2

My function has some redundancy, so let's add a new local variable *next* and replace all “a+b” with it:

```
#include <stdio.h>
```

<sup>4</sup>By the way, it's possible to select several entries in OllyDbg and copy them to the clipboard (Ctrl-C). That's what was done by author for this example.

<sup>5</sup>i.e., it calls itself

```

void fib (int a, int b, int limit)
{
    int next=a+b;
    printf ("%d\n", next);
    if (next > limit)
        return;
    fib (b, next, limit);
};

int main()
{
    printf ("0\n1\n1\n");
    fib (1, 1, 20);
};

```

This is the output of non-optimizing MSVC, so the *next* variable is actually allocated in the local stack:

Listing 3.8: MSVC 2010 x86

```

_next$ = -4      ; size = 4
_a$ = 8         ; size = 4
_b$ = 12        ; size = 4
_limit$ = 16    ; size = 4
_fib  PROC
    push    ebp
    mov     ebp, esp
    push    ecx
    mov     eax, DWORD PTR _a$[ebp]
    add     eax, DWORD PTR _b$[ebp]
    mov     DWORD PTR _next$[ebp], eax
    mov     ecx, DWORD PTR _next$[ebp]
    push    ecx
    push    OFFSET $SG2751 ; '%d'
    call   DWORD PTR __imp__printf
    add     esp, 8
    mov     edx, DWORD PTR _next$[ebp]
    cmp     edx, DWORD PTR _limit$[ebp]
    jle    SHORT $LN1@fib
    jmp     SHORT $LN2@fib
$LN1@fib:
    mov     eax, DWORD PTR _limit$[ebp]
    push    eax
    mov     ecx, DWORD PTR _next$[ebp]
    push    ecx
    mov     edx, DWORD PTR _b$[ebp]
    push    edx
    call   _fib
    add     esp, 12
$LN2@fib:
    mov     esp, ebp
    pop     ebp
    ret     0
_fib  ENDP

_main  PROC
    push    ebp
    mov     ebp, esp
    push    OFFSET $SG2753 ; "0\n1\n1\n"
    call   DWORD PTR __imp__printf
    add     esp, 4
    push    20
    push    1
    push    1
    call   _fib
    add     esp, 12
    xor     eax, eax
    pop     ebp
    ret     0
_main  ENDP

```

Let's load it in OllyDbg once again:

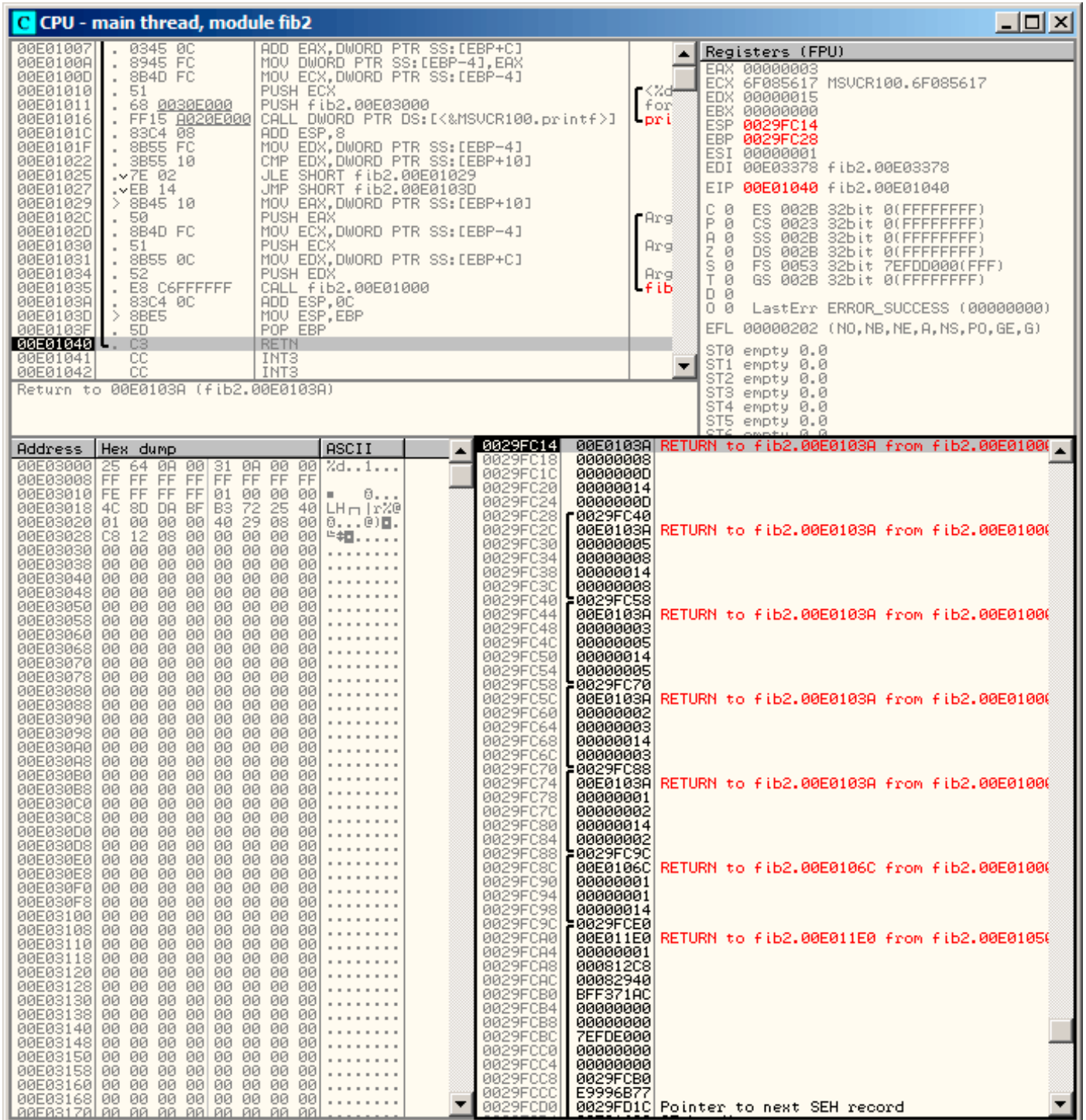

Figure 3.2: OllyDbg: last call of f ( )

Now the next variable is present in each frame.

Let's investigate the stack more closely. The author has again added his comments:

```

0029FC14 00E0103A RETURN to fib2.00E0103A from fib2.00E01000
0029FC18 00000008 1st argument: a
0029FC1C 0000000D 2nd argument: b
0029FC20 00000014 3rd argument: limit
0029FC24 0000000D "next" variable
0029FC28 /0029FC40 saved EBP register
0029FC2C |00E0103A RETURN to fib2.00E0103A from fib2.00E01000
0029FC30 |00000005 1st argument: a
0029FC34 |00000008 2nd argument: b
0029FC38 |00000014 3rd argument: limit
0029FC3C |00000008 "next" variable
0029FC40 ]0029FC58 saved EBP register
0029FC44 |00E0103A RETURN to fib2.00E0103A from fib2.00E01000
0029FC48 |00000003 1st argument: a
0029FC4C |00000005 2nd argument: b
0029FC50 |00000014 3rd argument: limit
0029FC54 |00000005 "next" variable
0029FC58 ]0029FC70 saved EBP register
0029FC5C |00E0103A RETURN to fib2.00E0103A from fib2.00E01000
0029FC60 |00000002 1st argument: a
0029FC64 |00000003 2nd argument: b
0029FC68 |00000014 3rd argument: limit
0029FC6C |00000003 "next" variable
0029FC70 ]0029FC88 saved EBP register
0029FC74 |00E0103A RETURN to fib2.00E0103A from fib2.00E01000
0029FC78 |00000001 1st argument: a \
0029FC7C |00000002 2nd argument: b | prepared in f1() for next f1() call
0029FC80 |00000014 3rd argument: limit /
0029FC84 |00000002 "next" variable
0029FC88 ]0029FC9C saved EBP register
0029FC8C |00E0106C RETURN to fib2.00E0106C from fib2.00E01000
0029FC90 |00000001 1st argument: a \
0029FC94 |00000001 2nd argument: b | prepared in main() for f1()
0029FC98 |00000014 3rd argument: limit /
0029FC9C ]0029FCE0 saved EBP register
0029FCA0 |00E011E0 RETURN to fib2.00E011E0 from fib2.00E01050
0029FCA4 |00000001 main() 1st argument: argc \
0029FCA8 |000812C8 main() 2nd argument: argv | prepared in CRT for main()
0029FCAC |00082940 main() 3rd argument: envp /

```

Here we see it: the *next* value is calculated in each function incarnation, then passed as argument *b* to the next incarnation.

### 3.7.3 Summary

Recursive functions are aesthetically nice, but technically may degrade performance because of their heavy stack usage. Everyone who writes performance critical code probably should avoid recursion.

For example, the author of this book once wrote a function to seek a particular node in a binary tree. As a recursive function it looked quite stylish but since additional time was spent at each function call for the prologue/epilogue, it was working a couple of times slower than an iterative (recursion-free) implementation.

By the way, that is the reason that some functional PL<sup>6</sup> compilers (where recursion is used heavily) use [tail call](#). We talk about tail call when a function has only one single call to itself located at the end of it, like:

Listing 3.9: Scheme, example is copy-pasted from Wikipedia

```

;; factorial : number -> number
;; to calculate the product of all positive
;; integers less than or equal to n.
(define (factorial n)
  (if (= n 1)
      1

```

<sup>6</sup>LISP, Python, Lua, etc.

```
(* n (factorial (- n 1))))
```

Tail call is important because compiler can rework this code easily into iterative one, to get rid of recursion.

## 3.8 CRC32 calculation example

This is a very popular table-based CRC32 hash calculation technique<sup>7</sup>.

```
/* By Bob Jenkins, (c) 2006, Public Domain */

#include <stdio.h>
#include <stddef.h>
#include <string.h>

typedef unsigned long ub4;
typedef unsigned char ub1;

static const ub4 crctab[256] = {
    0x00000000, 0x77073096, 0xee0e612c, 0x990951ba, 0x076dc419,
    0x706af48f, 0xe963a535, 0x9e6495a3, 0x0edb8832, 0x79dcb8a4,
    0xe0d5e91e, 0x97d2d988, 0x09b64c2b, 0x7eb17cbd, 0xe7b82d07,
    0x90bf1d91, 0x1db71064, 0x6ab020f2, 0xf3b97148, 0x84be41de,
    0x1dad47d, 0x6ddde4eb, 0xf4d4b551, 0x83d385c7, 0x136c9856,
    0x646ba8c0, 0xfd62f97a, 0x8a65c9ec, 0x14015c4f, 0x63066cd9,
    0xfa0f3d63, 0x8d080df5, 0x3b6e20c8, 0x4c69105e, 0xd56041e4,
    0xa2677172, 0x3c03e4d1, 0x4b04d447, 0xd20d85fd, 0xa50ab56b,
    0x35b5a8fa, 0x42b2986c, 0xdbbbc9d6, 0xacbcf940, 0x32d86ce3,
    0x45df5c75, 0xdcd60dcf, 0xabd13d59, 0x26d930ac, 0x51de003a,
    0xc8d75180, 0xbf06116, 0x21b4f4b5, 0x56b3c423, 0xcfba9599,
    0xb8bda50f, 0x2802b89e, 0x5f058808, 0xc60cd9b2, 0xb10be924,
    0x2f6f7c87, 0x58684c11, 0xc1611dab, 0xb6662d3d, 0x76dc4190,
    0x01db7106, 0x98d220bc, 0xefd5102a, 0x71b18589, 0x06b6b51f,
    0x9fbfe4a5, 0xe8b8d433, 0x7807c9a2, 0xf00f934, 0x9609a88e,
    0xe10e9818, 0x7f6a0dbb, 0x086d3d2d, 0x91646c97, 0xe6635c01,
    0x6b6b51f4, 0x1c6c6162, 0x856530d8, 0xf262004e, 0x6c0695ed,
    0x1b01a57b, 0x8208f4c1, 0xf50fc457, 0x65b0d9c6, 0x12b7e950,
    0x8bbeb8ea, 0xfcb9887c, 0x62dd1ddf, 0x15da2d49, 0x8cd37cf3,
    0xfbd44c65, 0x4db26158, 0x3ab551ce, 0xa3bc0074, 0xd4bb30e2,
    0xadfa541, 0x3dd895d7, 0xa4d1c46d, 0xd3d6f4fb, 0x4369e96a,
    0x346ed9fc, 0xad678846, 0xda60b8d0, 0x44042d73, 0x33031de5,
    0xaa0a4c5f, 0xdd0d7cc9, 0x5005713c, 0x270241aa, 0xbe0b1010,
    0xc90c2086, 0x5768b525, 0x206f85b3, 0xb966d409, 0xce61e49f,
    0x5edef90e, 0x29d9c998, 0xb0d09822, 0xc7d7a8b4, 0x59b33d17,
    0x2eb40d81, 0xb7bd5c3b, 0xc0ba6cad, 0xedb88320, 0x9abfb3b6,
    0x03b6e20c, 0x74b1d29a, 0xeada54739, 0x9dd277af, 0x04db2615,
    0x73dc1683, 0xe3630b12, 0x94643b84, 0x0d6d6a3e, 0x7a6a5aa8,
    0xe40ecf0b, 0x9309ff9d, 0x0a00ae27, 0x7d079eb1, 0xf00f9344,
    0x8708a3d2, 0x1e01f268, 0x6906c2fe, 0xf762575d, 0x806567cb,
    0x196c3671, 0x6e6b06e7, 0xfed41b76, 0x89d32be0, 0x10da7a5a,
    0x67dd4acc, 0xf9b9df6f, 0x8ebeeff9, 0x17b7be43, 0x60b08ed5,
    0xd6d6a3e8, 0xa1d1937e, 0x38d8c2c4, 0x4fdfff252, 0xd1bb67f1,
    0xa6bc5767, 0x3fb506dd, 0x48b2364b, 0xd80d2bda, 0xaf0a1b4c,
    0x36034af6, 0x41047a60, 0xdf60efc3, 0xa867df55, 0x316e8eef,
    0x4669be79, 0xcb61b38c, 0xbc66831a, 0x256fd2a0, 0x5268e236,
    0xcc0c7795, 0xbb0b4703, 0x220216b9, 0x5505262f, 0xc5ba3bbe,
    0xb2bd0b28, 0x2bb45a92, 0x5cb36a04, 0xc2d7ffa7, 0xb5d0cfc31,
    0x2cd99e8b, 0x5bdeae1d, 0x9b64c2b0, 0xec63f226, 0x756aa39c,
    0x026d930a, 0x9c0906a9, 0xeb0e363f, 0x72076785, 0x05005713,
    0x95bf4a82, 0xe2b87a14, 0x7bb12bae, 0x0cb61b38, 0x92d28e9b,
    0xe5d5be0d, 0x7cdcefb7, 0x0bdbdf21, 0x86d3d2d4, 0xf1d4e242,
    0x68ddb3f8, 0x1fda836e, 0x81be16cd, 0xf6b9265b, 0x6fb077e1,
    0x18b74777, 0x88085ae6, 0xff0f6a70, 0x66063bca, 0x11010b5c,
    0x8f659eff, 0xf862ae69, 0x616bffd3, 0x166ccf45, 0xa00ae278,
    0xd70dd2ee, 0x4e048354, 0x3903b3c2, 0xa7672661, 0xd06016f7,
    0x4969474d, 0x3e6e77db, 0xaed16a4a, 0xd9d65adc, 0x40df0b66,
    0x37d83bf0, 0xa9bcae53, 0xdeb9ec5, 0x47b2cf7f, 0x30b5ffe9,
    0xbd9df21c, 0xcabac28a, 0x53b39330, 0x24b4a3a6, 0xbad03605,
```

<sup>7</sup>The source code has been taken from here: <http://go.yurichev.com/17327>



```

0xcd70693, 0x54de5729, 0x23d967bf, 0xb3667a2e, 0xc4614ab8,
0x5d681b02, 0x2a6f2b94, 0xb40bbe37, 0xc30c8ea1, 0x5a05df1b,
0x2d02ef8d
};

/* how to derive the values in crctab[] from polynomial 0xedb88320 */
void build_table()
{
    ub4 i, j;
    for (i=0; i<256; ++i) {
        j = i;
        j = (j>>1) ^ ((j&1) ? 0xedb88320 : 0);
        j = (j>>1) ^ ((j&1) ? 0xedb88320 : 0);
        j = (j>>1) ^ ((j&1) ? 0xedb88320 : 0);
        j = (j>>1) ^ ((j&1) ? 0xedb88320 : 0);
        j = (j>>1) ^ ((j&1) ? 0xedb88320 : 0);
        j = (j>>1) ^ ((j&1) ? 0xedb88320 : 0);
        j = (j>>1) ^ ((j&1) ? 0xedb88320 : 0);
        j = (j>>1) ^ ((j&1) ? 0xedb88320 : 0);
        printf("0x%.8lx, ", j);
        if (i%6 == 5) printf("\n");
    }
}

/* the hash function */
ub4 crc(const void *key, ub4 len, ub4 hash)
{
    ub4 i;
    const ub1 *k = key;
    for (hash=len, i=0; i<len; ++i)
        hash = (hash >> 8) ^ crctab[(hash & 0xff) ^ k[i]];
    return hash;
}

/* To use, try "gcc -o crc.c -o crc; crc < crc.c" */
int main()
{
    char s[1000];
    while (gets(s)) printf("%.8lx\n", crc(s, strlen(s), 0));
    return 0;
}

```

We are interested in the `crc()` function only. By the way, pay attention to the two loop initializers in the `for()` statement: `hash=len, i=0`. The C/C++ standard allows this, of course. The emitted code will contain two operations in the loop initialization part instead of one.

Let's compile it in MSVC with optimization (`/Ox`). For the sake of brevity, only the `crc()` function is listed here, with my comments.

```

_key$ = 8           ; size = 4
_len$ = 12         ; size = 4
_hash$ = 16       ; size = 4
_crc PROC
    mov     edx, DWORD PTR _len$[esp-4]
    xor     ecx, ecx ; i will be stored in ECX
    mov     eax, edx
    test    edx, edx
    jbe    SHORT $LN1@crc
    push    ebx
    push    esi
    mov     esi, DWORD PTR _key$[esp+4] ; ESI = key
    push    edi
$LL3@crc:
; work with bytes using only 32-bit registers. byte from address key+i we store into EDI
    movzx  edi, BYTE PTR [ecx+esi]
    mov     ebx, eax ; EBX = (hash = len)
    and     ebx, 255 ; EBX = hash & 0xff

```

```
; XOR EDI, EBX (EDI=EDI^EBX) - this operation uses all 32 bits of each register
; but other bits (8-31) are cleared all time, so it is OK
; these are cleared because, as for EDI, it was done by MOVZX instruction above
; high bits of EBX was cleared by AND EBX, 255 instruction above (255 = 0xff)
```

```
    xor    edi, ebx

; EAX=EAX>>8; bits 24-31 taken from nowhere will be cleared
    shr    eax, 8

; EAX=EAX^crctab[EDI*4] - choose EDI-th element from crctab[] table
    xor    eax, DWORD PTR _crctab[edi*4]
    inc    ecx          ; i++
    cmp    ecx, edx     ; i<len ?
    jb     SHORT $LL3@crc ; yes
    pop    edi
    pop    esi
    pop    ebx
$LN1@crc:
    ret    0
_crc    ENDP
```

Let's try the same in GCC 4.4.1 with -O3 option:

```

crc
    public crc
    proc near

key
    = dword ptr 8
hash
    = dword ptr 0Ch

    push    ebp
    xor     edx, edx
    mov     ebp, esp
    push    esi
    mov     esi, [ebp+key]
    push    ebx
    mov     ebx, [ebp+hash]
    test    ebx, ebx
    mov     eax, ebx
    jz     short loc_80484D3
    nop
    lea    esi, [esi+0] ; padding; works as NOP (ESI does not change here)

loc_80484B8:
    mov     ecx, eax ; save previous state of hash to ECX
    xor     al, [esi+edx] ; AL=*(key+i)
    add     edx, 1 ; i++
    shr     ecx, 8 ; ECX=hash>>8
    movzx   eax, al ; EAX=*(key+i)
    mov     eax, dword ptr ds:crctab[eax*4] ; EAX=crctab[EAX]
    xor     eax, ecx ; hash=EAX^ECX
    cmp     ebx, edx
    ja     short loc_80484B8

loc_80484D3:
    pop     ebx
    pop     esi
    pop     ebp
    retn

crc
    endp
```

GCC has aligned the loop start on a 8-byte boundary by adding NOP and `lea esi, [esi+0]` (that is an *idle operation* too). Read more about it in `npad` section ([.1.7 on page 1039](#)).

### 3.9 Network address calculation example

As we know, a TCP/IP address (IPv4) consists of four numbers in the 0...255 range, i.e., four bytes.

Four bytes can be fit in a 32-bit variable easily, so an IPv4 host address, network mask or network address can all be 32-bit integers.

From the user's point of view, the network mask is defined as four numbers and is formatted like 255.255.255.0 or so, but network engineers (sysadmins) use a more compact notation ([CIDR<sup>8</sup>](#)), like "/8", "/16", etc.

This notation just defines the number of bits the mask has, starting at the **MSB**.

Mask	Hosts	Usable	Netmask	Hex mask	
/30	4	2	255.255.255.252	0xffffffc	
/29	8	6	255.255.255.248	0xfffff8	
/28	16	14	255.255.255.240	0xfffff0	
/27	32	30	255.255.255.224	0xffffe0	
/26	64	62	255.255.255.192	0xffffc0	
/24	256	254	255.255.255.0	0xffff00	class C network
/23	512	510	255.255.254.0	0xffffe00	
/22	1024	1022	255.255.252.0	0xffffc00	
/21	2048	2046	255.255.248.0	0xffff800	
/20	4096	4094	255.255.240.0	0xffff000	
/19	8192	8190	255.255.224.0	0xffffe000	
/18	16384	16382	255.255.192.0	0xffffc000	
/17	32768	32766	255.255.128.0	0xffff8000	
/16	65536	65534	255.255.0.0	0xffff0000	class B network
/8	16777216	16777214	255.0.0.0	0xff000000	class A network

Here is a small example, which calculates the network address by applying the network mask to the host address.

```
#include <stdio.h>
#include <stdint.h>

uint32_t form_IP (uint8_t ip1, uint8_t ip2, uint8_t ip3, uint8_t ip4)
{
    return (ip1<<24) | (ip2<<16) | (ip3<<8) | ip4;
};

void print_as_IP (uint32_t a)
{
    printf ("%d.%d.%d.%d\n",
            (a>>24)&0xFF,
            (a>>16)&0xFF,
            (a>>8)&0xFF,
            (a)&0xFF);
};

// bit=31..0
uint32_t set_bit (uint32_t input, int bit)
{
    return input=input|(1<<bit);
};

uint32_t form_netmask (uint8_t netmask_bits)
{
    uint32_t netmask=0;
    uint8_t i;

    for (i=0; i<netmask_bits; i++)
        netmask=set_bit(netmask, 31-i);

    return netmask;
};

void calc_network_address (uint8_t ip1, uint8_t ip2, uint8_t ip3, uint8_t ip4, uint8_t ↵
    ↵ netmask_bits)
{
    uint32_t netmask=form_netmask(netmask_bits);
    uint32_t ip=form_IP(ip1, ip2, ip3, ip4);
    uint32_t netw_adr;
```

<sup>8</sup>Classless Inter-Domain Routing

```

    printf ("netmask=");
    print_as_IP (netmask);

    netw_adr=ip&netmask;

    printf ("network address=");
    print_as_IP (netw_adr);
};

int main()
{
    calc_network_address (10, 1, 2, 4, 24);    // 10.1.2.4, /24
    calc_network_address (10, 1, 2, 4, 8);     // 10.1.2.4, /8
    calc_network_address (10, 1, 2, 4, 25);    // 10.1.2.4, /25
    calc_network_address (10, 1, 2, 64, 26);   // 10.1.2.4, /26
};

```

### 3.9.1 calc\_network\_address()

calc\_network\_address() function is simplest one: it just ANDs the host address with the network mask, resulting in the network address.

Listing 3.10: Optimizing MSVC 2012 /Ob0

```

1  _ip1$ = 8           ; size = 1
2  _ip2$ = 12          ; size = 1
3  _ip3$ = 16          ; size = 1
4  _ip4$ = 20          ; size = 1
5  _netmask_bits$ = 24 ; size = 1
6  _calc_network_address PROC
7      push     edi
8      push     DWORD PTR _netmask_bits$[esp]
9      call    _form_netmask
10     push     OFFSET $SG3045 ; 'netmask='
11     mov     edi, eax
12     call    DWORD PTR __imp__printf
13     push     edi
14     call    _print_as_IP
15     push     OFFSET $SG3046 ; 'network address='
16     call    DWORD PTR __imp__printf
17     push     DWORD PTR _ip4$[esp+16]
18     push     DWORD PTR _ip3$[esp+20]
19     push     DWORD PTR _ip2$[esp+24]
20     push     DWORD PTR _ip1$[esp+28]
21     call    _form_IP
22     and     eax, edi           ; network address = host address & netmask
23     push     eax
24     call    _print_as_IP
25     add     esp, 36
26     pop     edi
27     ret     0
28 _calc_network_address ENDP

```

At line 22 we see the most important AND—here the network address is calculated.

### 3.9.2 form\_IP()

The form\_IP() function just puts all 4 bytes into a 32-bit value.

Here is how it is usually done:

- Allocate a variable for the return value. Set it to 0.
- Take the fourth (lowest) byte, apply OR operation to this byte and return the value. The return value contain the 4th byte now.
- Take the third byte, shift it left by 8 bits. You'll get a value like 0x0000bb00 where bb is your third byte. Apply the OR operation to the resulting value and returning value. The return value has contained 0x000000aa so far, so ORing the values will produce a value like 0x0000bbaa.

- Take the second byte, shift it left by 16 bits. You'll get a value like 0x00cc0000, where cc is your second byte. Apply the OR operation to the resulting value and returning value. The return value has contained 0x0000bbaa so far, so ORing the values will produce a value like 0x00ccbbaa.
- Take the first byte, shift it left by 24 bits. You'll get a value like 0xdd000000, where dd is your first byte. Apply the OR operation to the resulting value and returning value. The return value has contained 0x00ccbbaa so far, so ORing the values will produce a value like 0xddccbbaa.

And this is how it's done by non-optimizing MSVC 2012:

Listing 3.11: Non-optimizing MSVC 2012

```
; denote ip1 as "dd", ip2 as "cc", ip3 as "bb", ip4 as "aa".
_ip1$ = 8      ; size = 1
_ip2$ = 12     ; size = 1
_ip3$ = 16     ; size = 1
_ip4$ = 20     ; size = 1
_form_IP PROC
    push     ebp
    mov     ebp, esp
    movzx   eax, BYTE PTR _ip1$[ebp]
    ; EAX=000000dd
    shl     eax, 24
    ; EAX=dd000000
    movzx   ecx, BYTE PTR _ip2$[ebp]
    ; ECX=000000cc
    shl     ecx, 16
    ; ECX=00cc0000
    or      eax, ecx
    ; EAX=ddcc0000
    movzx   edx, BYTE PTR _ip3$[ebp]
    ; EDX=000000bb
    shl     edx, 8
    ; EDX=0000bb00
    or      eax, edx
    ; EAX=ddccbb00
    movzx   ecx, BYTE PTR _ip4$[ebp]
    ; ECX=000000aa
    or      eax, ecx
    ; EAX=ddccbbaa
    pop     ebp
    ret     0
_form_IP ENDP
```

Well, the order is different, but, of course, the order of the operations doesn't matter.

Optimizing MSVC 2012 does essentially the same, but in a different way:

Listing 3.12: Optimizing MSVC 2012 /Ob0

```
; denote ip1 as "dd", ip2 as "cc", ip3 as "bb", ip4 as "aa".
_ip1$ = 8      ; size = 1
_ip2$ = 12     ; size = 1
_ip3$ = 16     ; size = 1
_ip4$ = 20     ; size = 1
_form_IP PROC
    movzx   eax, BYTE PTR _ip1$[esp-4]
    ; EAX=000000dd
    movzx   ecx, BYTE PTR _ip2$[esp-4]
    ; ECX=000000cc
    shl     eax, 8
    ; EAX=0000dd00
    or      eax, ecx
    ; EAX=0000ddcc
    movzx   ecx, BYTE PTR _ip3$[esp-4]
    ; ECX=000000bb
    shl     eax, 8
    ; EAX=00ddcc00
    or      eax, ecx
    ; EAX=00ddccbb
    movzx   ecx, BYTE PTR _ip4$[esp-4]
    ; ECX=000000aa
```

```

    shl     eax, 8
    ; EAX=ddccbb00
    or      eax, ecx
    ; EAX=ddccbbaa
    ret     0
_form_IP ENDP

```

We could say that each byte is written to the lowest 8 bits of the return value, and then the return value is shifted left by one byte at each step.

Repeat 4 times for each input byte.

That's it! Unfortunately, there are probably no other ways to do it.

There are no popular CPUs or ISAs which has instruction for composing a value from bits or bytes.

It's all usually done by bit shifting and ORing.

### 3.9.3 print\_as\_IP()

print\_as\_IP() does the inverse: splitting a 32-bit value into 4 bytes.

Slicing works somewhat simpler: just shift input value by 24, 16, 8 or 0 bits, take the bits from zeroth to seventh (lowest byte), and that's it:

Listing 3.13: Non-optimizing MSVC 2012

```

_a$ = 8                ; size = 4
_print_as_IP PROC
    push    ebp
    mov     ebp, esp
    mov     eax, DWORD PTR _a$[ebp]
    ; EAX=ddccbbaa
    and     eax, 255
    ; EAX=000000aa
    push    eax
    mov     ecx, DWORD PTR _a$[ebp]
    ; ECX=ddccbbaa
    shr     ecx, 8
    ; ECX=00ddccbb
    and     ecx, 255
    ; ECX=000000bb
    push    ecx
    mov     edx, DWORD PTR _a$[ebp]
    ; EDX=ddccbbaa
    shr     edx, 16
    ; EDX=0000ddcc
    and     edx, 255
    ; EDX=000000cc
    push    edx
    mov     eax, DWORD PTR _a$[ebp]
    ; EAX=ddccbbaa
    shr     eax, 24
    ; EAX=000000dd
    and     eax, 255 ; probably redundant instruction
    ; EAX=000000dd
    push    eax
    push    OFFSET $SG2973 ; '%d.%d.%d.%d'
    call    DWORD PTR __imp__printf
    add     esp, 20
    pop     ebp
    ret     0
_print_as_IP ENDP

```

Optimizing MSVC 2012 does almost the same, but without unnecessary reloading of the input value:

Listing 3.14: Optimizing MSVC 2012 /Ob0

```

_a$ = 8                ; size = 4
_print_as_IP PROC
    mov     ecx, DWORD PTR _a$[esp-4]
    ; ECX=ddccbbaa

```

```

movzx  eax, cl
; EAX=000000aa
push   eax
mov    eax, ecx
; EAX=ddccbbaa
shr    eax, 8
; EAX=00ddccbb
and    eax, 255
; EAX=000000bb
push   eax
mov    eax, ecx
; EAX=ddccbbaa
shr    eax, 16
; EAX=0000ddcc
and    eax, 255
; EAX=000000cc
push   eax
; ECX=ddccbbaa
shr    ecx, 24
; ECX=000000dd
push   ecx
push   OFFSET $SG3020 ; '%d.%d.%d.%d'
call   DWORD PTR __imp__printf
add    esp, 20
ret    0
_print_as_IP ENDP

```

### 3.9.4 form\_netmask() and set\_bit()

form\_netmask() makes a network mask value from CIDR notation. Of course, it would be much effective to use here some kind of a precalculated table, but we consider it in this way intentionally, to demonstrate bit shifts.

We will also write a separate function set\_bit(). It's a not very good idea to create a function for such primitive operation, but it would be easy to understand how it all works.

Listing 3.15: Optimizing MSVC 2012 /Ob0

```

_input$ = 8           ; size = 4
_bit$ = 12           ; size = 4
_set_bit PROC
    mov    ecx, DWORD PTR _bit$[esp-4]
    mov    eax, 1
    shl   eax, cl
    or    eax, DWORD PTR _input$[esp-4]
    ret    0
_set_bit ENDP

_netmask_bits$ = 8   ; size = 1
_form_netmask PROC
    push   ebx
    push   esi
    movzx  esi, BYTE PTR _netmask_bits$[esp+4]
    xor    ecx, ecx
    xor    bl, bl
    test   esi, esi
    jle    SHORT $LN9@form_netma
    xor    edx, edx
$LL3@form_netma:
    mov    eax, 31
    sub    eax, edx
    push   eax
    push   ecx
    call   _set_bit
    inc    bl
    movzx  edx, bl
    add    esp, 8
    mov    ecx, eax
    cmp    edx, esi

```

```

        jl      SHORT $LL3@form_netma
$LN9@form_netma:
        pop     esi
        mov     eax, ecx
        pop     ebx
        ret     0
_form_netmask ENDP

```

set\_bit() is primitive: it just shift left 1 to number of bits we need and then ORs it with the “input” value. form\_netmask() has a loop: it will set as many bits (starting from the **MSB**) as passed in the netmask\_bits argument

### 3.9.5 Summary

That’s it! We run it and getting:

```

netmask=255.255.255.0
network address=10.1.2.0
netmask=255.0.0.0
network address=10.0.0.0
netmask=255.255.255.128
network address=10.1.2.0
netmask=255.255.255.192
network address=10.1.2.64

```

## 3.10 Loops: several iterators

In most cases loops have only one iterator, but there could be several in the resulting code.

Here is a very simple example:

```

#include <stdio.h>

void f(int *a1, int *a2, size_t cnt)
{
    size_t i;

    // copy from one array to another in some weird scheme
    for (i=0; i<cnt; i++)
        a1[i*3]=a2[i*7];
};

```

There are two multiplications at each iteration and they are costly operations. Can we optimize it somehow?

Yes, if we notice that both array indices are jumping on values that we can easily calculate without multiplication.

### 3.10.1 Three iterators

Listing 3.16: Optimizing MSVC 2013 x64

```

f      PROC
; RCX=a1
; RDX=a2
; R8=cnt
        test    r8, r8      ; cnt==0? exit then
        je     SHORT $LN1@f
        npad   11
$LL3@f:
        mov     eax, DWORD PTR [rdx]
        lea    rcx, QWORD PTR [rcx+12]
        lea    rdx, QWORD PTR [rdx+28]
        mov     DWORD PTR [rcx-12], eax
        dec    r8

```



```

    jne    SHORT $LL3@f
$LN1@f:
    ret    0
f        ENDP

```

Now there are 3 iterators: the *cnt* variable and two indices, which are increased by 12 and 28 at each iteration. We can rewrite this code in C/C++:

```

#include <stdio.h>

void f(int *a1, int *a2, size_t cnt)
{
    size_t i;
    size_t idx1=0; idx2=0;

    // copy from one array to another in some weird scheme
    for (i=0; i<cnt; i++)
    {
        a1[idx1]=a2[idx2];
        idx1+=3;
        idx2+=7;
    };
};

```

So, at the cost of updating 3 iterators at each iteration instead of one, we can remove two multiplication operations.

### 3.10.2 Two iterators

GCC 4.9 does even more, leaving only 2 iterators:

Listing 3.17: Optimizing GCC 4.9 x64

```

; RDI=a1
; RSI=a2
; RDX=cnt
f:
    test    rdx, rdx ; cnt==0? exit then
    je     .L1
; calculate last element address in "a2" and leave it in RDX
    lea    rax, [0+rdx*4]
; RAX=RDX*4=cnt*4
    sal    rdx, 5
; RDX=RDX<<5=cnt*32
    sub    rdx, rax
; RDX=RDX-RAX=cnt*32-cnt*4=cnt*28
    add    rdx, rsi
; RDX=RDX+RSI=a2+cnt*28
.L3:
    mov    eax, DWORD PTR [rsi]
    add    rsi, 28
    add    rdi, 12
    mov    DWORD PTR [rdi-12], eax
    cmp    rsi, rdx
    jne    .L3
.L1:
    rep   ret

```

There is no *counter* variable any more: GCC concluded that it is not needed.

The last element of the *a2* array is calculated before the loop begins (which is easy:  $cnt * 7$ ) and that's how the loop is to be stopped: just iterate until the second index reaches this precalculated value.

You can read more about multiplication using shifts/additions/subtractions here: [1.24.1 on page 213](#).

This code can be rewritten into C/C++ like that:

```

#include <stdio.h>

void f(int *a1, int *a2, size_t cnt)

```

```

{
    size_t idx1=0; idx2=0;
    size_t last_idx2=cnt*7;

    // copy from one array to another in some weird scheme
    for (;;)
    {
        a1[idx1]=a2[idx2];
        idx1+=3;
        idx2+=7;
        if (idx2==last_idx2)
            break;
    };
};

```

GCC (Linaro) 4.9 for ARM64 does the same, but it precalculates the last index of *a1* instead of *a2*, which, of course has the same effect:

Listing 3.18: Optimizing GCC (Linaro) 4.9 ARM64

```

; X0=a1
; X1=a2
; X2=cnt
f:
    cbz    x2, .L1          ; cnt==0? exit then
; calculate last element of "a1" array
    add    x2, x2, x2, lsl 1
; X2=X2+X2<<1=X2+X2*2=X2*3
    mov    x3, 0
    lsl    x2, x2, 2
; X2=X2<<2=X2*4=X2*3*4=X2*12
.L3:
    ldr    w4, [x1],28      ; load at X1, add 28 to X1 (post-increment)
    str    w4, [x0,x3]     ; store at X0+X3=a1+X3
    add    x3, x3, 12      ; shift X3
    cmp    x3, x2          ; end?
    bne    .L3
.L1:
    ret

```

GCC 4.4.5 for MIPS does the same:

Listing 3.19: Optimizing GCC 4.4.5 for MIPS (IDA)

```

; $a0=a1
; $a1=a2
; $a2=cnt
f:
; jump to loop check code:
    beqz   $a2, locret_24
; initialize counter (i) at 0:
    move   $v0, $zero ; branch delay slot, NOP

loc_8:
; load 32-bit word at $a1
    lw    $a3, 0($a1)
; increment counter (i):
    addiu $v0, 1
; check for finish (compare "i" in $v0 and "cnt" in $a2):
    sltu  $v1, $v0, $a2
; store 32-bit word at $a0:
    sw    $a3, 0($a0)
; add 0x1C (28) to $a1 at each iteration:
    addiu $a1, 0x1C
; jump to loop body if i<cnt:
    bnez  $v1, loc_8
; add 0xC (12) to $a0 at each iteration:
    addiu $a0, 0xC ; branch delay slot

locret_24:
    jr    $ra

```

### 3.10.3 Intel C++ 2011 case

Compiler optimizations can also be weird, but nevertheless, still correct. Here is what the Intel C++ compiler 2011 does:

Listing 3.20: Optimizing Intel C++ 2011 x64

```
f      PROC
; parameter 1: rcx = a1
; parameter 2: rdx = a2
; parameter 3: r8 = cnt
.B1.1::
    test    r8, r8
    jbe     exit

.B1.2::
    cmp     r8, 6
    jbe     just_copy

.B1.3::
    cmp     rcx, rdx
    jbe     .B1.5

.B1.4::
    mov     r10, r8
    mov     r9, rcx
    shl     r10, 5
    lea     rax, QWORD PTR [r8*4]
    sub     r9, rdx
    sub     r10, rax
    cmp     r9, r10
    jge     just_copy2

.B1.5::
    cmp     rdx, rcx
    jbe     just_copy

.B1.6::
    mov     r9, rdx
    lea     rax, QWORD PTR [r8*8]
    sub     r9, rcx
    lea     r10, QWORD PTR [rax+r8*4]
    cmp     r9, r10
    jl      just_copy

just_copy2::
; R8 = cnt
; RDX = a2
; RCX = a1
    xor     r10d, r10d
    xor     r9d, r9d
    xor     eax, eax

.B1.8::
    mov     r11d, DWORD PTR [rax+rdx]
    inc     r10
    mov     DWORD PTR [r9+rcx], r11d
    add     r9, 12
    add     rax, 28
    cmp     r10, r8
    jb      .B1.8
    jmp     exit

just_copy::
; R8 = cnt
; RDX = a2
; RCX = a1
```

```

    xor     r10d, r10d
    xor     r9d, r9d
    xor     eax, eax

.B1.11::
    mov     r11d, DWORD PTR [rax+rdx]
    inc     r10
    mov     DWORD PTR [r9+rcx], r11d
    add     r9, 12
    add     rax, 28
    cmp     r10, r8
    jb     .B1.11

exit::
    ret

```

First, there are some decisions taken, then one of the routines is executed.

Looks like it is a check if arrays intersect.

This is very well known way of optimizing memory block copy routines. But copy routines are the same!

This is has to be an error of the Intel C++ optimizer, which still produces workable code, though.

We intentionally considering such example code in this book so the reader would understand that compiler output is weird at times, but still correct, because when the compiler was tested, it passed the tests.

### 3.11 Duff's device

Duff's device is an unrolled loop with the possibility to jump to the middle of it. The unrolled loop is implemented using a fallthrough switch() statement. We would use here a slightly simplified version of Tom Duff's original code. Let's say, we have to write a function that clears a region in memory. One can come with a simple loop, clearing byte by byte. It's obviously slow, since all modern computers have much wider memory bus. So the better way is to clear the memory region using 4 or 8 bytes blocks. Since we are going to work with a 64-bit example here, we are going to clear the memory in 8 bytes blocks. So far so good. But what about the tail? Memory clearing routine can also be called for regions of size that's not a multiple of 8. So here is the algorithm:

- calculate the number of 8-bytes blocks, clear them using 8-bytes (64-bit) memory accesses;
- calculate the size of the tail, clear it using 1-byte memory accesses.

The second step can be implemented using a simple loop. But let's implement it as an unrolled loop:

```

#include <stdint.h>
#include <stdio.h>

void bzero(uint8_t* dst, size_t count)
{
    int i;

    if (count & (~7))
        // work out 8-byte blocks
        for (i=0; i<count>>3; i++)
        {
            *(uint64_t*)dst=0;
            dst=dst+8;
        };

    // work out the tail
    switch(count & 7)
    {
    case 7: *dst++ = 0;
    case 6: *dst++ = 0;
    case 5: *dst++ = 0;
    case 4: *dst++ = 0;
    case 3: *dst++ = 0;
    case 2: *dst++ = 0;
    case 1: *dst++ = 0;
    case 0: // do nothing
    }
}

```

```

        break;
    }
}

```

Let's first understand how the calculation is performed. The memory region size comes as a 64-bit value. And this value can be divided in two parts:

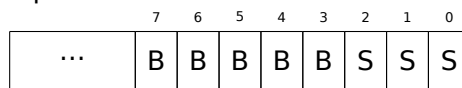

( "B" is number of 8-byte blocks and "S" is length of the tail in bytes ).

When we divide the input memory region size by 8, the value is just shifted right by 3 bits. But to calculate the remainder, we can just isolate the lowest 3 bits! So the number of 8-byte blocks is calculated as  $count \gg 3$  and remainder as  $count \& 7$ . We also have to find out if we are going to execute the 8-byte procedure at all, so we need to check if the value of  $count$  is greater than 7. We do this by clearing the 3 lowest bits and comparing the resulting number with zero, because all we need here is to answer the question, is the high part of  $count$  non-zero. Of course, this works because 8 is  $2^3$  and division by numbers that are  $2^n$  is easy. It's not possible for other numbers. It's actually hard to say if these hacks are worth using, because they lead to hard-to-read code. However, these tricks are very popular and a practicing programmer, even if he/she is not using them, nevertheless has to understand them.

So the first part is simple: get the number of 8-byte blocks and write 64-bit zero values to memory. The second part is an unrolled loop implemented as fallthrough switch() statement.

First, let's express in plain English what we have to do here.

We have to "write as many zero bytes in memory, as  $count \& 7$  value tells us". If it's 0, jump to the end, there is no work to do. If it's 1, jump to the place inside switch() statement where only one storage operation is to be executed. If it's 2, jump to another place, where two storage operation are to be executed, etc. 7 as input value leads to the execution of all 7 operations. There is no 8, because a memory region of 8 bytes is to be processed by the first part of our function. So we wrote an unrolled loop. It was definitely faster on older computers than normal loops (and conversely, latest CPUs works better for short loops than for unrolled ones). Maybe this is still meaningful on modern low-cost embedded MCU<sup>9</sup>s.

Let's see what the optimizing MSVC 2012 does:

```

dst$ = 8
count$ = 16
bzero PROC
    test    rdx, -8
    je     SHORT $LN11@bzero
; work out 8-byte blocks
    xor    r10d, r10d
    mov    r9, rdx
    shr    r9, 3
    mov    r8d, r10d
    test   r9, r9
    je     SHORT $LN11@bzero
    npad   5
$LL19@bzero:
    inc    r8d
    mov    QWORD PTR [rcx], r10
    add    rcx, 8
    movsxd rax, r8d
    cmp    rax, r9
    jb     SHORT $LL19@bzero
$LN11@bzero:
; work out the tail
    and    edx, 7
    dec    rdx
    cmp    rdx, 6
    ja     SHORT $LN9@bzero
    lea    r8, OFFSET FLAT:__ImageBase
    mov    eax, DWORD PTR $LN22@bzero[r8+rdx*4]
    add    rax, r8
    jmp    rax
$LN8@bzero:
    mov    BYTE PTR [rcx], 0

```

<sup>9</sup>Microcontroller Unit

```

    inc    rcx
$LN7@bzero:
    mov    BYTE PTR [rcx], 0
    inc    rcx
$LN6@bzero:
    mov    BYTE PTR [rcx], 0
    inc    rcx
$LN5@bzero:
    mov    BYTE PTR [rcx], 0
    inc    rcx
$LN4@bzero:
    mov    BYTE PTR [rcx], 0
    inc    rcx
$LN3@bzero:
    mov    BYTE PTR [rcx], 0
    inc    rcx
$LN2@bzero:
    mov    BYTE PTR [rcx], 0
$LN9@bzero:
    fatret 0
    npad   1
$LN22@bzero:
    DD    $LN2@bzero
    DD    $LN3@bzero
    DD    $LN4@bzero
    DD    $LN5@bzero
    DD    $LN6@bzero
    DD    $LN7@bzero
    DD    $LN8@bzero
bzero   ENDP

```

The first part of the function is predictable. The second part is just an unrolled loop and a jump passing control flow to the correct instruction inside it. There is no other code between the MOV/INC instruction pairs, so the execution is to fall until the very end, executing as many pairs as needed. By the way, we can observe that the MOV/INC pair consumes a fixed number of bytes (3+3). So the pair consumes 6 bytes. Knowing that, we can get rid of the switch() jumtable, we can just multiple the input value by 6 and jump to *current\_RIP + input\_value \* 6*.

This can also be faster because we are not in need to fetch a value from the jumtable.

It's possible that 6 probably is not a very good constant for fast multiplication and maybe it's not worth it, but you get the idea<sup>10</sup>.

That is what old-school demomakers did in the past with unrolled loops.

### 3.11.1 Should one use unrolled loops?

Unrolled loops can have benefits if there is no fast cache memory between RAM and CPU, and the CPU, in order to get the code of the next instruction, must load it from RAM each time. This is a case of modern low-cost MCU and old CPUs.

Unrolled loops are slower than short loops if there is a fast cache between RAM and CPU and the body of loop can fit into cache, and CPU will load the code from it not touching the RAM. Fast loops are the loops which body's size can fit into L1 cache, but even faster loops are those small ones which can fit into micro-operation cache.

## 3.12 Division using multiplication

A very simple function:

```

int f(int a)
{
    return a/9;
};

```

<sup>10</sup>As an exercise, you can try to rework the code to get rid of the jumtable. The instruction pair can be rewritten in a way that it will consume 4 bytes or maybe 8. 1 byte is also possible (using STOSB instruction).

### 3.12.1 x86

...is compiled in a very predictable way:

Listing 3.21: MSVC

```
_a$ = 8 ; size = 4
_f PROC
    push    ebp
    mov     ebp, esp
    mov     eax, DWORD PTR _a$[ebp]
    cdq    ; sign extend EAX to EDX:EAX
    mov     ecx, 9
    idiv   ecx
    pop     ebp
    ret     0
_f ENDP
```

IDIV divides the 64-bit number stored in the EDX:EAX register pair by the value in the ECX. As a result, EAX will contain the [quotient](#), and EDX— the remainder. The result is returned from the `f()` function in the EAX register, so the value is not moved after the division operation, it is in right place already.

Since IDIV uses the value in the EDX:EAX register pair, the CDQ instruction (before IDIV) extends the value in EAX to a 64-bit value taking its sign into account, just as MOVSBX does.

If we turn optimization on (`/Ox`), we get:

Listing 3.22: Optimizing MSVC

```
_a$ = 8 ; size = 4
_f PROC

    mov     ecx, DWORD PTR _a$[esp-4]
    mov     eax, 954437177 ; 38e38e39H
    imul   ecx
    sar    edx, 1
    mov     eax, edx
    shr    eax, 31 ; 0000001fH
    add    eax, edx
    ret     0
_f ENDP
```

This is division by multiplication. Multiplication operations work much faster. And it is possible to use this trick <sup>11</sup> to produce code which is effectively equivalent and faster.

This is also called “strength reduction” in compiler optimizations.

GCC 4.4.1 generates almost the same code even without additional optimization flags, just like MSVC with optimization turned on:

Listing 3.23: Non-optimizing GCC 4.4.1

```
public f
f      proc near

arg_0 = dword ptr 8

    push    ebp
    mov     ebp, esp
    mov     ecx, [ebp+arg_0]
    mov     edx, 954437177 ; 38E38E39h
    mov     eax, ecx
    imul   edx
    sar    edx, 1
    mov     eax, ecx
    sar    eax, 1Fh
    mov     ecx, edx
    sub    ecx, eax
    mov     eax, ecx
    pop     ebp
    retn
```

<sup>11</sup>Read more about division by multiplication in [Henry S. Warren, *Hacker's Delight*, (2002)10-3]

### 3.12.2 How it works

From school-level mathematics, we can remember that division by 9 can be replaced by multiplication by  $\frac{1}{9}$ . In fact, sometimes compilers do so for floating-point arithmetics, for example, FDIV instruction in x86 code can be replaced by FMUL. At least MSVC 6.0 will replace division by 9 by multiplication by 0.111111... and sometimes it's hard to be sure, what operation was in the original source code.

But when we operate over integer values and integer CPU registers, we can't use fractions. However, we can rework fraction like that:

$$result = \frac{x}{9} = x \cdot \frac{1}{9} = x \cdot \frac{1 \cdot MagicNumber}{9 \cdot MagicNumber}$$

Given the fact that division by  $2^n$  is very fast (using shifts), we now should find that *MagicNumber*, for which the following equation will be true:  $2^n = 9 \cdot MagicNumber$ .

Division by  $2^{32}$  is somewhat hidden: lower 32-bit of product in EAX is not used (dropped), only higher 32-bit of product (in EDX) is used and then shifted by additional 1 bit.

In other words, the assembly code we have just seen multiplies by  $\frac{954437177}{2^{32+1}}$ , or divides by  $\frac{2^{32+1}}{954437177}$ . To find a divisor we just have to divide numerator by denominator. Using Wolfram Alpha, we can get 8.99999999... as result (which is close to 9).

Read more about it in [Henry S. Warren, *Hacker's Delight*, (2002)10-3].

Many people miss "hidden" division by  $2^{32}$  or  $2^{64}$ , when lower 32-bit part (or 64-bit part) of product is not used. This is why division by multiplication is difficult to understand at the beginning.

Mathematics for Programmers<sup>12</sup> has yet another explanation.

### 3.12.3 ARM

The ARM processor, just like in any other "pure" RISC processor lacks an instruction for division. It also lacks a single instruction for multiplication by a 32-bit constant (recall that a 32-bit constant cannot fit into a 32-bit opcode).

By taking advantage of this clever trick (or *hack*), it is possible to do division using only three instructions: addition, subtraction and bit shifts ( 1.28 on page 305).

Here is an example that divides a 32-bit number by 10, from [Advanced RISC Machines Ltd, *The ARM Cookbook*, (1994)3.3 Division by a Constant]. The output consists of the quotient and the remainder.

```
; takes argument in a1
; returns quotient in a1, remainder in a2
; cycles could be saved if only divide or remainder is required
SUB    a2, a1, #10           ; keep (x-10) for later
SUB    a1, a1, a1, lsr #2
ADD    a1, a1, a1, lsr #4
ADD    a1, a1, a1, lsr #8
ADD    a1, a1, a1, lsr #16
MOV    a1, a1, lsr #3
ADD    a3, a1, a1, asl #2
SUBS   a2, a2, a3, asl #1    ; calc (x-10) - (x/10)*10
ADDPL  a1, a1, #1           ; fix-up quotient
ADDMI  a2, a2, #10         ; fix-up remainder
MOV    pc, lr
```

### Optimizing Xcode 4.6.3 (LLVM) (ARM mode)

```
__text:00002C58 39 1E 08 E3 E3 18 43 E3 MOV    R1, 0x38E38E39
__text:00002C60 10 F1 50 E7          SMMUL  R0, R0, R1
__text:00002C64 C0 10 A0 E1          MOV    R1, R0,ASR#1
__text:00002C68 A0 0F 81 E0          ADD    R0, R1, R0,LSR#31
__text:00002C6C 1E FF 2F E1          BX    LR
```

<sup>12</sup><https://yurichev.com/writings/Math-for-programmers.pdf>



This code is almost the same as the one generated by the optimizing MSVC and GCC.

Apparently, LLVM uses the same algorithm for generating constants.

The observant reader may ask, how does MOV writes a 32-bit value in a register, when this is not possible in ARM mode.

it is impossible indeed, but, as we see, there are 8 bytes per instruction instead of the standard 4, in fact, there are two instructions.

The first instruction loads 0x8E39 into the low 16 bits of register and the second instruction is MOVT, it loads 0x383E into the high 16 bits of the register. IDA is fully aware of such sequences, and for the sake of compactness reduces them to one single “pseudo-instruction”.

The SMMUL (*Signed Most Significant Word Multiply*) instruction two multiplies numbers, treating them as signed numbers and leaving the high 32-bit part of result in the R0 register, dropping the low 32-bit part of the result.

The “MOV R1, R0, ASR#1” instruction is an arithmetic shift right by one bit.

“ADD R0, R1, R0, LSR#31” is  $R0 = R1 + R0 \gg 31$

There is no separate shifting instruction in ARM mode. Instead, an instructions like (MOV, ADD, SUB, RSB)<sup>13</sup> can have a suffix added, that says if the second operand must be shifted, and if yes, by what value and how. ASR stands for *Arithmetic Shift Right*, LSR—*Logical Shift Right*.

### Optimizing Xcode 4.6.3 (LLVM) (Thumb-2 mode)

MOV	R1, 0x38E38E39
SMMUL.W	R0, R0, R1
ASRS	R1, R0, #1
ADD.W	R0, R1, R0, LSR#31
BX	LR

There are separate instructions for shifting in Thumb mode, and one of them is used here—ASRS (arithmetic shift right).

### Non-optimizing Xcode 4.6.3 (LLVM) and Keil 6/2013

Non-optimizing LLVM does not generate the code we saw before in this section, but instead inserts a call to the library function `__divsi3`.

What about Keil: it inserts a call to the library function `__aeabi_idivmod` in all cases.

### 3.12.4 MIPS

For some reason, optimizing GCC 4.4.5 generate just a division instruction:

Listing 3.24: Optimizing GCC 4.4.5 (IDA)

f:	li	\$v0, 9
	bnez	\$v0, loc_10
	div	\$a0, \$v0 ; branch delay slot
	break	0x1C00 ; "break 7" in assembly output and objdump
loc_10:	mflo	\$v0
	jr	\$ra
	or	\$at, \$zero ; branch delay slot, NOP

Here we see here a new instruction: BREAK. It just raises an exception.

In this case, an exception is raised if the divisor is zero (it’s not possible to divide by zero in conventional math).

But GCC probably did not do very well the optimization job and did not see that \$V0 is never zero.

<sup>13</sup>These instructions are also called “data processing instructions”

So the check is left here. So if \$V0 is zero somehow, BREAK is to be executed, signaling to the OS about the exception.

Otherwise, MFLO executes, which takes the result of the division from the LO register and copies it in \$V0.

By the way, as we may know, the MUL instruction leaves the high 32 bits of the result in register HI and the low 32 bits in register LO.

DIV leaves the result in the LO register, and remainder in the HI register.

If we alter the statement to “a % 9”, the MFHI instruction is to be used here instead of MFLO.

### 3.12.5 Exercise

- <http://challenges.re/27>

## 3.13 String to number conversion (atoi())

Let's try to reimplement the standard atoi() C function.

### 3.13.1 Simple example

Here is the simplest possible way to read a number represented in ASCII encoding.

It's not error-prone: a character other than a digit leads to incorrect result.

```
#include <stdio.h>

int my_atoi (char *s)
{
    int rt=0;

    while (*s)
    {
        rt=rt*10 + (*s-'0');
        s++;
    };

    return rt;
};

int main()
{
    printf ("%d\n", my_atoi ("1234"));
    printf ("%d\n", my_atoi ("1234567890"));
};
```

So what the algorithm does is just reading digits from left to right.

The zero ASCII character is subtracted from each digit.

The digits from “0” to “9” are consecutive in the ASCII table, so we do not even need to know the exact value of the “0” character.

All we have to know is that “0” minus “0” is 0, “9” minus “0” is 9 and so on.

Subtracting “0” from each character results in a number from 0 to 9 inclusive.

Any other character leads to an incorrect result, of course!

Each digit has to be added to the final result (in variable “rt”), but the final result is also multiplied by 10 at each digit.

In other words, the result is shifted left by one position in decimal form on each iteration.

The last digit is added, but there is no shift.

## Optimizing MSVC 2013 x64

Listing 3.25: Optimizing MSVC 2013 x64

```
s$ = 8
my_atoi PROC
; load first character
    movzx    r8d, BYTE PTR [rcx]
; EAX is allocated for "rt" variable
; its 0 at start
    xor     eax, eax
; first character is zero-byte, i.e., string terminator?
; exit then.
    test    r8b, r8b
    je     SHORT $LN9@my_atoi
$LL2@my_atoi:
    lea    edx, DWORD PTR [rax+rax*4]
; EDX=RAX+RAX*4=rt+rt*4=rt*5
    movsx  eax, r8b
; EAX=input character
; load next character to R8D
    movzx  r8d, BYTE PTR [rcx+1]
; shift pointer in RCX to the next character:
    lea    rcx, QWORD PTR [rcx+1]
    lea    eax, DWORD PTR [rax+rdx*2]
; EAX=RAX+RDX*2=input character + rt*5*2=input character + rt*10
; correct digit by subtracting 48 (0x30 or '0')
    add    eax, -48 ; ffffffff00000000H
; was the last character zero?
    test   r8b, r8b
; jump to loop begin, if not
    jne    SHORT $LL2@my_atoi
$LN9@my_atoi:
    ret    0
my_atoi ENDP
```

A character can be loaded in two places: the first character and all subsequent characters. This is arranged so for loop regrouping.

There is no instruction for multiplication by 10, two LEA instruction do this instead.

MSVC sometimes uses the ADD instruction with a negative constant instead of SUB. This is the case.

It's very hard to say why this is better than SUB. But MSVC does this often.

## Optimizing GCC 4.9.1 x64

Optimizing GCC 4.9.1 is more concise, but there is one redundant RET instruction at the end. One would be enough.

Listing 3.26: Optimizing GCC 4.9.1 x64

```
my_atoi:
; load input character into EDX
    movsx  edx, BYTE PTR [rdi]
; EAX is allocated for "rt" variable
    xor    eax, eax
; exit, if loaded character is null byte
    test  dl, dl
    je    .L4
.L3:
    lea   eax, [rax+rax*4]
; EAX=RAX*5=rt*5
; shift pointer to the next character:
    add   rdi, 1
    lea  eax, [rdi-48+rax*2]
; EAX=input character - 48 + RAX*2 = input character - '0' + rt*10
; load next character:
    movsx edx, BYTE PTR [rdi]
; goto loop begin, if loaded character is not null byte
    test  dl, dl
```

```

    jne    .L3
    rep ret
.L4:
    rep ret

```

## Optimizing Keil 6/2013 (ARM mode)

Listing 3.27: Optimizing Keil 6/2013 (ARM mode)

```

my_atoi PROC
; R1 will contain pointer to character
    MOV    r1,r0
; R0 will contain "rt" variable
    MOV    r0,#0
    B      |L0.28|
|L0.12|
    ADD    r0,r0,r0,LSL #2
; R0=R0+R0<<2=rt*5
    ADD    r0,r2,r0,LSL #1
; R0=input character + rt*5<<1 = input character + rt*10
; correct whole thing by subtracting '0' from rt:
    SUB    r0,r0,#0x30
; shift pointer to the next character:
    ADD    r1,r1,#1
|L0.28|
; load input character to R2
    LDRB   r2,[r1,#0]
; is it null byte? if no, jump to loop body.
    CMP    r2,#0
    BNE    |L0.12|
; exit if null byte.
; "rt" variable is still in R0 register, ready to be used in caller function
    BX    lr
    ENDP

```

## Optimizing Keil 6/2013 (Thumb mode)

Listing 3.28: Optimizing Keil 6/2013 (Thumb mode)

```

my_atoi PROC
; R1 will be pointer to the input character
    MOVS   r1,r0
; R0 is allocated to "rt" variable
    MOVS   r0,#0
    B      |L0.16|
|L0.6|
    MOVS   r3,#0xa
; R3=10
    MULS   r0,r3,r0
; R0=R3*R0=rt*10
; shift pointer to the next character:
    ADDS   r1,r1,#1
; correct whole thing by subtracting '0' character from it:
    SUBS   r0,r0,#0x30
    ADDS   r0,r2,r0
; rt=R2+R0=input character + (rt*10 - '0')
|L0.16|
; load input character to R2
    LDRB   r2,[r1,#0]
; is it zero?
    CMP    r2,#0
; jump to loop body if it is not
    BNE    |L0.6|
; rt variable in R0 now, ready to be used in caller function
    BX    lr
    ENDP

```

Interestingly, from school mathematics we may recall that the order of addition and subtraction operations doesn't matter.

That's our case: first, the  $rt * 10 - '0'$  expression is computed, then the input character value is added to it. Indeed, the result is the same, but the compiler did some regrouping.

### Optimizing GCC 4.9.1 ARM64

The ARM64 compiler can use the pre-increment instruction suffix:

Listing 3.29: Optimizing GCC 4.9.1 ARM64

```
my_atoi:
; load input character into W1
    ldrb    w1, [x0]
    mov     x2, x0
; X2=address of input string
; is loaded character zero?
; jump to exit if its so
; W1 will contain 0 in this case.
; it will be reloaded into W0 at L4.
    cbz     w1, .L4
; W0 will contain "rt" variable
; initialize it at zero:
    mov     w0, 0
.L3:
; subtract 48 or '0' from input variable and put result into W3:
    sub     w3, w1, #48
; load next character at address X2+1 into W1 with pre-increment:
    ldrb    w1, [x2,1]!
    add     w0, w0, w0, lsl 2
; W0=W0+W0<<2=W0+W0*4=rt*5
    add     w0, w3, w0, lsl 1
; W0=input digit + W0<<1 = input digit + rt*5*2 = input digit + rt*10
; if the character we just loaded is not null byte, jump to the loop begin
    cbnz   w1, .L3
; variable to be returned (rt) is in W0, ready to be used in caller function
    ret
.L4:
    mov     w0, w1
    ret
```

### 3.13.2 A slightly advanced example

My new code snippet is more advanced, now it checks for the "minus" sign at the first character and reports an error if a non-digit has been found in the input string:

```
#include <stdio.h>

int my_atoi (char *s)
{
    int negative=0;
    int rt=0;

    if (*s=='-')
    {
        negative=1;
        s++;
    };

    while (*s)
    {
        if (*s<'0' || *s>'9')
        {
            printf ("Error! Unexpected char: '%c'\n", *s);
            exit(0);
        };
        rt=rt*10 + (*s-'0');
        s++;
    }
}
```

```

};

if (negative)
    return -rt;
return rt;
};

int main()
{
    printf ("%d\n", my_atoi ("1234"));
    printf ("%d\n", my_atoi ("1234567890"));
    printf ("%d\n", my_atoi ("-1234"));
    printf ("%d\n", my_atoi ("-1234567890"));
    printf ("%d\n", my_atoi ("-a1234567890")); // error
};

```

## Optimizing GCC 4.9.1 x64

Listing 3.30: Optimizing GCC 4.9.1 x64

```

.LC0:
    .string "Error! Unexpected char: '%c'\n"

my_atoi:
    sub    rsp, 8
    movsx  edx, BYTE PTR [rdi]
; check for minus sign
    cmp    dl, 45 ; '-'
    je     .L22
    xor    esi, esi
    test   dl, dl
    je     .L20

.L10:
; ESI=0 here if there was no minus sign and 1 if it was
    lea    eax, [rdx-48]
; any character other than digit will result in unsigned number greater than 9 after subtraction
; so if it is not digit, jump to L4, where error will be reported:
    cmp    al, 9
    ja     .L4
    xor    eax, eax
    jmp    .L6

.L7:
    lea    ecx, [rdx-48]
    cmp    cl, 9
    ja     .L4

.L6:
    lea    eax, [rax+rax*4]
    add    rdi, 1
    lea    eax, [rdx-48+rax*2]
    movsx  edx, BYTE PTR [rdi]
    test   dl, dl
    jne    .L7
; if there was no minus sign, skip NEG instruction
; if it was, execute it.
    test   esi, esi
    je     .L18
    neg    eax

.L18:
    add    rsp, 8
    ret

.L22:
    movsx  edx, BYTE PTR [rdi+1]
    lea    rax, [rdi+1]
    test   dl, dl
    je     .L20
    mov    rdi, rax
    mov    esi, 1
    jmp    .L10

.L20:

```

```

        xor     eax, eax
        jmp     .L18
.L4:
; report error. character is in EDX
        mov     edi, 1
        mov     esi, OFFSET FLAT:.LC0 ; "Error! Unexpected char: '%c'\n"
        xor     eax, eax
        call    __printf_chk
        xor     edi, edi
        call    exit

```

If the “minus” sign has been encountered at the string start, the NEG instruction is to be executed at the end. It just negates the number.

There is one more thing that needs mentioning.

How would a common programmer check if the character is not a digit? Just how we have it in the source code:

```

if (*s<'0' || *s>'9')
    ...

```

There are two comparison operations.

What is interesting is that we can replace both operations by single one: just subtract “0” from character value,

treat result as unsigned value (this is important) and check if it’s greater than 9.

For example, let’s say that the user input contains the dot character (“.”) which has [ASCII](#) code 46.  $46 - 48 = -2$  if we treat the result as a signed number.

Indeed, the dot character is located two places earlier than the “0” character in the [ASCII](#) table. But it is 0xFFFFFFFF (4294967294) if we treat the result as an unsigned value, and that’s definitely bigger than 9!

The compilers do this often, so it’s important to recognize these tricks.

Another example of it in this book: [3.19.1 on page 538](#).

Optimizing MSVC 2013 x64 does the same tricks.

## Optimizing Keil 6/2013 (ARM mode)

Listing 3.31: Optimizing Keil 6/2013 (ARM mode)

```

1 my_atoi PROC
2     PUSH     {r4-r6,lr}
3     MOV     r4,r0
4     LDRB    r0,[r0,#0]
5     MOV     r6,#0
6     MOV     r5,r6
7     CMP     r0,#0x2d '-'
8 ; R6 will contain 1 if minus was encountered, 0 if otherwise
9     MOVEQ   r6,#1
10    ADDEQ   r4,r4,#1
11    B       |L0.80|
12 |L0.36|
13    SUB     r0,r1,#0x30
14    CMP     r0,#0xa
15    BCC    |L0.64|
16    ADR     r0,|L0.220|
17    BL     __2printf
18    MOV     r0,#0
19    BL     exit
20 |L0.64|
21    LDRB    r0,[r4],#1
22    ADD     r1,r5,r5,LSL #2
23    ADD     r0,r0,r1,LSL #1
24    SUB     r5,r0,#0x30
25 |L0.80|

```

```

26         LDRB    r1,[r4,#0]
27         CMP     r1,#0
28         BNE     |L0.36|
29         CMP     r6,#0
30 ; negate result
31         RSBNE   r0,r5,#0
32         MOVEQ   r0,r5
33         POP     {r4-r6,pc}
34         ENDP
35
36 |L0.220|
37         DCB     "Error! Unexpected char: '%c'\n",0

```

There is no NEG instruction in 32-bit ARM, so the “Reverse Subtraction” operation (line 31) is used here. It is triggered if the result of the CMP instruction (at line 29) has been “Not Equal” (hence -NE suffix).

So what RSBNE does is to subtract the resulting value from 0.

It works just like the regular subtraction operation, but swaps operands.

Subtracting any number from 0 results in negation:  $0 - x = -x$ .

Thumb mode code is mostly the same.

GCC 4.9 for ARM64 can use the NEG instruction, which is available in ARM64.

### 3.13.3 Exercise

Oh, by the way, security researchers deals often with unpredictable behavior of program while handling of incorrect data.

For example, while fuzzing. As an exercise, you may try to enter non-digit characters and see what happens.

Try to explain, what happened and why.

## 3.14 Inline functions

Inlined code is when the compiler, instead of placing a call instruction to a small or tiny function, just places its body right in-place.

Listing 3.32: A simple example

```

#include <stdio.h>

int celsius_to_fahrenheit (int celsius)
{
    return celsius * 9 / 5 + 32;
};

int main(int argc, char *argv[])
{
    int celsius=atol(argv[1]);
    printf ("%d\n", celsius_to_fahrenheit (celsius));
};

```

...is compiled in very predictable way, however, if we turn on GCC optimizations (-O3), we'll see:

Listing 3.33: Optimizing GCC 4.8.1

```

_main:
    push    ebp
    mov     ebp, esp
    and     esp, -16
    sub     esp, 16
    call   __main
    mov     eax, DWORD PTR [ebp+12]
    mov     eax, DWORD PTR [eax+4]
    mov     DWORD PTR [esp], eax
    call   _atol

```



```

mov     edx, 1717986919
mov     DWORD PTR [esp], OFFSET FLAT:LC2 ; "%d\n"
lea     ecx, [eax+eax*8]
mov     eax, ecx
imul   edx
sar     ecx, 31
sar     edx
sub     edx, ecx
add     edx, 32
mov     DWORD PTR [esp+4], edx
call    _printf
leave
ret

```

(Here the division is performed by multiplication( [3.12 on page 500](#).)

Yes, our small function `celsius_to_fahrenheit()` has just been placed before the `printf()` call.

Why? It can be faster than executing this function's code plus the overhead of calling/returning.

Modern optimizing compilers are choosing small functions for inlining automatically. But it's possible to force compiler additionally to inline some function, if to mark it with the "inline" keyword in its declaration.

### 3.14.1 Strings and memory functions

Another very common automatic optimization tactic is the inlining of string functions like `strcpy()`, `strcmp()`, `strlen()`, `memset()`, `memcpy()`, `memcopy()`, etc..

Sometimes it's faster than to call a separate function.

These are very frequent patterns and it is highly advisable for reverse engineers to learn to detect automatically.

#### **strcmp()**

Listing 3.34: strcmp() example

```

bool is_bool (char *s)
{
    if (strcmp (s, "true")==0)
        return true;
    if (strcmp (s, "false")==0)
        return false;

    assert(0);
};

```

Listing 3.35: Optimizing GCC 4.8.1

```

.LC0:
.string "true"
.LC1:
.string "false"
is_bool:
.LFB0:
push    edi
mov     ecx, 5
push    esi
mov     edi, OFFSET FLAT:.LC0
sub     esp, 20
mov     esi, DWORD PTR [esp+32]
repz   cmpsb
je     .L3
mov     esi, DWORD PTR [esp+32]
mov     ecx, 6
mov     edi, OFFSET FLAT:.LC1
repz   cmpsb
seta   cl
setb   dl
xor     eax, eax

```

```

    cmp     cl, dl
    jne    .L8
    add    esp, 20
    pop    esi
    pop    edi
    ret

.L8:
    mov    DWORD PTR [esp], 0
    call   assert
    add    esp, 20
    pop    esi
    pop    edi
    ret

.L3:
    add    esp, 20
    mov    eax, 1
    pop    esi
    pop    edi
    ret

```

Listing 3.36: Optimizing MSVC 2010

```

$SG3454 DB    'true', 00H
$SG3456 DB    'false', 00H

_s$ = 8      ; size = 4
?is_bool@@YA_NPAD@Z PROC ; is_bool
    push   esi
    mov    esi, DWORD PTR _s$[esp]
    mov    ecx, OFFSET $SG3454 ; 'true'
    mov    eax, esi
    npad   4 ; align next label
$LL6@is_bool:
    mov    dl, BYTE PTR [eax]
    cmp    dl, BYTE PTR [ecx]
    jne    $LN7@is_bool
    test   dl, dl
    je     $LN8@is_bool
    mov    dl, BYTE PTR [eax+1]
    cmp    dl, BYTE PTR [ecx+1]
    jne    $LN7@is_bool
    add    eax, 2
    add    ecx, 2
    test   dl, dl
    jne    $LL6@is_bool
$LN8@is_bool:
    xor    eax, eax
    jmp    $LN9@is_bool
$LN7@is_bool:
    sbb    eax, eax
    sbb    eax, -1
$LN9@is_bool:
    test   eax, eax
    jne    $LN2@is_bool

    mov    al, 1
    pop    esi

    ret    0
$LN2@is_bool:

    mov    ecx, OFFSET $SG3456 ; 'false'
    mov    eax, esi
$LL10@is_bool:
    mov    dl, BYTE PTR [eax]
    cmp    dl, BYTE PTR [ecx]
    jne    $LN11@is_bool
    test   dl, dl
    je     $LN12@is_bool
    mov    dl, BYTE PTR [eax+1]

```

```

    cmp     dl, BYTE PTR [ecx+1]
    jne     SHORT $LN11@is_bool
    add     eax, 2
    add     ecx, 2
    test    dl, dl
    jne     SHORT $LL10@is_bool
$LN12@is_bool:
    xor     eax, eax
    jmp     SHORT $LN13@is_bool
$LN11@is_bool:
    sbb     eax, eax
    sbb     eax, -1
$LN13@is_bool:
    test    eax, eax
    jne     SHORT $LN1@is_bool

    xor     al, al
    pop     esi

    ret     0
$LN1@is_bool:

    push    11
    push    OFFSET $SG3458
    push    OFFSET $SG3459
    call   DWORD PTR __imp__wassert
    add     esp, 12
    pop     esi

    ret     0
?is_bool@@YA_NPAD@Z ENDP ; is_bool

```

## strlen()

Listing 3.37: strlen() example

```

int strlen_test(char *s1)
{
    return strlen(s1);
};

```

Listing 3.38: Optimizing MSVC 2010

```

_s1$ = 8 ; size = 4
_strlen_test PROC
    mov     eax, DWORD PTR _s1$[esp-4]
    lea     edx, DWORD PTR [eax+1]
$LL3@strlen_tes:
    mov     cl, BYTE PTR [eax]
    inc     eax
    test    cl, cl
    jne     SHORT $LL3@strlen_tes
    sub     eax, edx
    ret     0
_strlen_test ENDP

```

## strcpy()

Listing 3.39: strcpy() example

```

void strcpy_test(char *s1, char *outbuf)
{
    strcpy(outbuf, s1);
};

```

Listing 3.40: Optimizing MSVC 2010

```

_s1$ = 8 ; size = 4

```

```

_outbuf$ = 12 ; size = 4
_strcpy_test PROC
    mov     eax, DWORD PTR _s1$[esp-4]
    mov     edx, DWORD PTR _outbuf$[esp-4]
    sub     edx, eax
    npad   6 ; align next label
$LL3@strcpy_tes:
    mov     cl, BYTE PTR [eax]
    mov     BYTE PTR [edx+eax], cl
    inc     eax
    test    cl, cl
    jne     SHORT $LL3@strcpy_tes
    ret     0
_strcpy_test ENDP

```

## memset()

### Example#1

Listing 3.41: 32 bytes

```

#include <stdio.h>

void f(char *out)
{
    memset(out, 0, 32);
};

```

Many compilers don't generate a call to memset() for short blocks, but rather insert a pack of MOVs:

Listing 3.42: Optimizing GCC 4.9.1 x64

```

f:
    mov     QWORD PTR [rdi], 0
    mov     QWORD PTR [rdi+8], 0
    mov     QWORD PTR [rdi+16], 0
    mov     QWORD PTR [rdi+24], 0
    ret

```

By the way, that remind us of unrolled loops: [1.22.1 on page 192](#).

### Example#2

Listing 3.43: 67 bytes

```

#include <stdio.h>

void f(char *out)
{
    memset(out, 0, 67);
};

```

When the block size is not a multiple of 4 or 8, the compilers can behave differently.

For instance, MSVC 2012 continues to insert MOVs:

Listing 3.44: Optimizing MSVC 2012 x64

```

out$ = 8
f     PROC
    xor     eax, eax
    mov     QWORD PTR [rcx], rax
    mov     QWORD PTR [rcx+8], rax
    mov     QWORD PTR [rcx+16], rax
    mov     QWORD PTR [rcx+24], rax
    mov     QWORD PTR [rcx+32], rax
    mov     QWORD PTR [rcx+40], rax
    mov     QWORD PTR [rcx+48], rax

```

```

    mov     QWORD PTR [rcx+56], rax
    mov     WORD PTR [rcx+64], ax
    mov     BYTE PTR [rcx+66], al
    ret     0
f:      ENDP

```

...while GCC uses REP STOSQ, concluding that this would be shorter than a pack of MOVs:

Listing 3.45: Optimizing GCC 4.9.1 x64

```

f:      mov     QWORD PTR [rdi], 0
    mov     QWORD PTR [rdi+59], 0
    mov     rcx, rdi
    lea    rdi, [rdi+8]
    xor     eax, eax
    and     rdi, -8
    sub     rcx, rdi
    add     ecx, 67
    shr     ecx, 3
    rep    stosq
    ret

```

## memcpy()

### Short blocks

The routine to copy short blocks is often implemented as a sequence of MOV instructions.

Listing 3.46: memcpy() example

```

void memcpy_7(char *inbuf, char *outbuf)
{
    memcpy(outbuf+10, inbuf, 7);
};

```

Listing 3.47: Optimizing MSVC 2010

```

_inbuf$ = 8      ; size = 4
_outbuf$ = 12   ; size = 4
_memcpy_7 PROC
    mov     ecx, DWORD PTR _inbuf$[esp-4]
    mov     edx, DWORD PTR [ecx]
    mov     eax, DWORD PTR _outbuf$[esp-4]
    mov     DWORD PTR [eax+10], edx
    mov     dx, WORD PTR [ecx+4]
    mov     WORD PTR [eax+14], dx
    mov     cl, BYTE PTR [ecx+6]
    mov     BYTE PTR [eax+16], cl
    ret     0
_memcpy_7 ENDP

```

Listing 3.48: Optimizing GCC 4.8.1

```

memcpy_7:
    push   ebx
    mov    eax, DWORD PTR [esp+8]
    mov    ecx, DWORD PTR [esp+12]
    mov    ebx, DWORD PTR [eax]
    lea   edx, [ecx+10]
    mov   DWORD PTR [ecx+10], ebx
    movzx ecx, WORD PTR [eax+4]
    mov   WORD PTR [edx+4], cx
    movzx eax, BYTE PTR [eax+6]
    mov   BYTE PTR [edx+6], al
    pop   ebx
    ret

```

That's usually done as follows: 4-byte blocks are copied first, then a 16-bit word (if needed), then the last byte (if needed).

Structures are also copied using MOV: [1.30.4 on page 361](#).

## Long blocks

The compilers behave differently in this case.

Listing 3.49: memcpy() example

```
void memcpy_128(char *inbuf, char *outbuf)
{
    memcpy(outbuf+10, inbuf, 128);
};

void memcpy_123(char *inbuf, char *outbuf)
{
    memcpy(outbuf+10, inbuf, 123);
};
```

For copying 128 bytes, MSVC uses a single MOVSD instruction (because 128 divides evenly by 4):

Listing 3.50: Optimizing MSVC 2010

```
_inbuf$ = 8           ; size = 4
_outbuf$ = 12        ; size = 4
_memcpy_128 PROC
    push    esi
    mov     esi, DWORD PTR _inbuf$[esp]
    push    edi
    mov     edi, DWORD PTR _outbuf$[esp+4]
    add     edi, 10
    mov     ecx, 32
    rep movsd
    pop     edi
    pop     esi
    ret     0
_memcpy_128 ENDP
```

When copying 123 bytes, 30 32-bit words are copied first using MOVSD (that's 120 bytes), then 2 bytes are copied using MOVSW, then one more byte using MOVSB.

Listing 3.51: Optimizing MSVC 2010

```
_inbuf$ = 8           ; size = 4
_outbuf$ = 12        ; size = 4
_memcpy_123 PROC
    push    esi
    mov     esi, DWORD PTR _inbuf$[esp]
    push    edi
    mov     edi, DWORD PTR _outbuf$[esp+4]
    add     edi, 10
    mov     ecx, 30
    rep movsd
    movsw
    movsb
    pop     edi
    pop     esi
    ret     0
_memcpy_123 ENDP
```

GCC uses one big universal functions, that works for any block size:

Listing 3.52: Optimizing GCC 4.8.1

```
memcpy_123:
.LFB3:
    push    edi
    mov     eax, 123
```

```

    push    esi
    mov     edx, DWORD PTR [esp+16]
    mov     esi, DWORD PTR [esp+12]
    lea    edi, [edx+10]
    test   edi, 1
    jne    .L24
    test   edi, 2
    jne    .L25
.L7:
    mov     ecx, eax
    xor     edx, edx
    shr     ecx, 2
    test   al, 2
    rep movsd
    je     .L8
    movzx  edx, WORD PTR [esi]
    mov    WORD PTR [edi], dx
    mov    edx, 2
.L8:
    test   al, 1
    je     .L5
    movzx  eax, BYTE PTR [esi+edx]
    mov    BYTE PTR [edi+edx], al
.L5:
    pop    esi
    pop    edi
    ret
.L24:
    movzx  eax, BYTE PTR [esi]
    lea    edi, [edx+11]
    add    esi, 1
    test   edi, 2
    mov    BYTE PTR [edx+10], al
    mov    eax, 122
    je     .L7
.L25:
    movzx  edx, WORD PTR [esi]
    add    edi, 2
    add    esi, 2
    sub    eax, 2
    mov    WORD PTR [edi-2], dx
    jmp    .L7
.LFE3:

```

Universal memory copy functions usually work as follows: calculate how many 32-bit words can be copied, then copy them using MOVSD, then copy the remaining bytes.

More advanced and complex copy functions use SIMD instructions and also take the memory alignment in consideration.

As an example of SIMD strlen() function: [1.36.2 on page 418](#).

## memcmp()

Listing 3.53: memcmp() example

```

int memcmp_1235(char *buf1, char *buf2)
{
    return memcmp(buf1, buf2, 1235);
};

```

For any block size, MSVC 2013 inserts the same universal function:

Listing 3.54: Optimizing MSVC 2010

```

_buf1$ = 8      ; size = 4
_buf2$ = 12     ; size = 4
_memcmp_1235 PROC
    mov     ecx, DWORD PTR _buf1$[esp-4]
    mov     edx, DWORD PTR _buf2$[esp-4]

```

```

    push    esi
    mov     esi, 1231
    npad   2
$LL5@memcmp_123:
    mov     eax, DWORD PTR [ecx]
    cmp     eax, DWORD PTR [edx]
    jne     SHORT $LN4@memcmp_123
    add     ecx, 4
    add     edx, 4
    sub     esi, 4
    jae     SHORT $LL5@memcmp_123
$LN4@memcmp_123:
    mov     al, BYTE PTR [ecx]
    cmp     al, BYTE PTR [edx]
    jne     SHORT $LN6@memcmp_123
    mov     al, BYTE PTR [ecx+1]
    cmp     al, BYTE PTR [edx+1]
    jne     SHORT $LN6@memcmp_123
    mov     al, BYTE PTR [ecx+2]
    cmp     al, BYTE PTR [edx+2]
    jne     SHORT $LN6@memcmp_123
    cmp     esi, -1
    je      SHORT $LN3@memcmp_123
    mov     al, BYTE PTR [ecx+3]
    cmp     al, BYTE PTR [edx+3]
    jne     SHORT $LN6@memcmp_123
$LN3@memcmp_123:
    xor     eax, eax
    pop     esi
    ret     0
$LN6@memcmp_123:
    sbb     eax, eax
    or      eax, 1
    pop     esi
    ret     0
_memcmp_1235 ENDP

```

## strcat()

This is inlined strcat() as it has been generated by MSVC 6.0. There are 3 parts visible: 1) getting source string length (first scasb); 2) getting destination string length (second scasb); 3) copying source string into the end of destination string (movsd/movsb pair).

Listing 3.55: strcat()

```

    lea     edi, [src]
    or      ecx, 0FFFFFFFh
    repne  scasb
    not     ecx
    sub     edi, ecx
    mov     esi, edi
    mov     edi, [dst]
    mov     edx, ecx
    or      ecx, 0FFFFFFFh
    repne  scasb
    mov     ecx, edx
    dec     edi
    shr     ecx, 2
    rep  movsd
    mov     ecx, edx
    and     ecx, 3
    rep  movsb

```

## IDA script

There is also a small [IDA](#) script for searching and folding such very frequently seen pieces of inline code: [GitHub](#).



## 3.15 C99 restrict

Here is a reason why Fortran programs, in some cases, work faster than C/C++ ones.

```
void f1 (int* x, int* y, int* sum, int* product, int* sum_product, int* update_me, size_t s)
{
    for (int i=0; i<s; i++)
    {
        sum[i]=x[i]+y[i];
        product[i]=x[i]*y[i];
        update_me[i]=i*123; // some dummy value
        sum_product[i]=sum[i]+product[i];
    };
};
```

That's very simple example with one specific thing in it: the pointer to the `update_me` array could be a pointer to the `sum` array, `product` array, or even the `sum_product` array—nothing forbids that, right?

The compiler is fully aware of this, so it generates code with four stages in the loop body:

- calculate next `sum[i]`
- calculate next `product[i]`
- calculate next `update_me[i]`
- calculate next `sum_product[i]`—on this stage, we need to load from memory the already calculated `sum[i]` and `product[i]`

Is it possible to optimize the last stage? Since we have already calculated `sum[i]` and `product[i]` it is not necessary to load them again from memory.

Yes, but compiler is not sure that nothing has been overwritten at the 3rd stage! This is called “pointer aliasing”, a situation when the compiler cannot be sure that a memory to which a pointer is pointing hasn't been changed.

*restrict* in the C99 standard [ISO/IEC 9899:TC3 (C C99 standard), (2007) 6.7.3/1] is a promise, given by programmer to the compiler that the function arguments marked by this keyword always points to different memory locations and never intersects.

To be more precise and describe this formally, *restrict* shows that only this pointer is to be used to access an object, and no other pointer will be used for it.

It can be even said the object will be accessed only via one single pointer, if it is marked as *restrict*.

Let's add this keyword to each pointer argument:

```
void f2 (int* restrict x, int* restrict y, int* restrict sum, int* restrict product, int* ↵
    ↵ restrict sum_product,
        int* restrict update_me, size_t s)
{
    for (int i=0; i<s; i++)
    {
        sum[i]=x[i]+y[i];
        product[i]=x[i]*y[i];
        update_me[i]=i*123; // some dummy value
        sum_product[i]=sum[i]+product[i];
    };
};
```

Let's see results:

Listing 3.56: GCC x64: f1()

```
f1:
    push    r15 r14 r13 r12 rbp rdi rsi rbx
    mov     r13, QWORD PTR 120[rsi]
    mov     rbp, QWORD PTR 104[rsi]
    mov     r12, QWORD PTR 112[rsi]
    test    r13, r13
```

```

je      .L1
add     r13, 1
xor     ebx, ebx
mov     edi, 1
xor     r11d, r11d
jmp     .L4
.L6:
mov     r11, rdi
mov     rdi, rax
.L4:
lea     rax, 0[0+r11*4]
lea     r10, [rcx+rax]
lea     r14, [rdx+rax]
lea     rsi, [r8+rax]
add     rax, r9
mov     r15d, DWORD PTR [r10]
add     r15d, DWORD PTR [r14]
mov     DWORD PTR [rsi], r15d      ; store to sum[]
mov     r10d, DWORD PTR [r10]
imul   r10d, DWORD PTR [r14]
mov     DWORD PTR [rax], r10d     ; store to product[]
mov     DWORD PTR [r12+r11*4], ebx ; store to update_me[]
add     ebx, 123
mov     r10d, DWORD PTR [rsi]     ; reload sum[i]
add     r10d, DWORD PTR [rax]     ; reload product[i]
lea     rax, 1[rdi]
cmp     rax, r13
mov     DWORD PTR 0[rbp+r11*4], r10d ; store to sum_product[]
jne     .L6
.L1:
pop     rbx rsi rdi rbp r12 r13 r14 r15
ret

```

Listing 3.57: GCC x64: f2()

```

f2:
push   r13 r12 rbp rdi rsi rbx
mov    r13, QWORD PTR 104[rsp]
mov    rbp, QWORD PTR 88[rsp]
mov    r12, QWORD PTR 96[rsp]
test   r13, r13
je     .L7
add    r13, 1
xor    r10d, r10d
mov    edi, 1
xor    eax, eax
jmp    .L10
.L11:
mov    rax, rdi
mov    rdi, r11
.L10:
mov    esi, DWORD PTR [rcx+rax*4]
mov    r11d, DWORD PTR [rdx+rax*4]
mov    DWORD PTR [r12+rax*4], r10d ; store to update_me[]
add    r10d, 123
lea    ebx, [rsi+r11]
imul  r11d, esi
mov    DWORD PTR [r8+rax*4], ebx ; store to sum[]
mov    DWORD PTR [r9+rax*4], r11d ; store to product[]
add    r11d, ebx
mov    DWORD PTR 0[rbp+rax*4], r11d ; store to sum_product[]
lea    r11, 1[rdi]
cmp    r11, r13
jne    .L11
.L7:
pop    rbx rsi rdi rbp r12 r13
ret

```

The difference between the compiled f1() and f2() functions is as follows: in f1(), sum[i] and product[i] are reloaded in the middle of the loop, and in f2() there is no such thing, the already calculated values

are used, since we “promised” the compiler that no one and nothing will change the values in `sum[i]` and `product[i]` during the execution of the loop’s body, so it is “sure” that there is no need to load the value from memory again.

Obviously, the second example works faster.

But what if the pointers in the function’s arguments intersect somehow?

This is on the programmer’s conscience, and the results will be incorrect.

Let’s go back to Fortran.

Compilers of this programming language treats all pointers as such, so when it was not possible to set *restrict* in C, Fortran could generate faster code in these cases.

How practical is it?

In the cases when the function works with several big blocks in memory.

There are a lot of such in linear algebra, for instance.

Supercomputers/[HPC<sup>14</sup>](#) are very busy with linear algebra, so probably that is why, traditionally, Fortran is still used there [Eugene Loh, *The Ideal HPC Programming Language*, (2010)].

But when the number of iterations is not very big, certainly, the speed boost may not to be significant.

## 3.16 Branchless *abs()* function

Let’s revisit an example we considered earlier [1.18.2 on page 141](#) and ask ourselves, is it possible to make a branchless version of the function in x86 code?

```
int my_abs (int i)
{
    if (i<0)
        return -i;
    else
        return i;
};
```

And the answer is yes.

### 3.16.1 Optimizing GCC 4.9.1 x64

We could see it if we compile it using optimizing GCC 4.9:

Listing 3.58: Optimizing GCC 4.9 x64

```
my_abs:
    mov     edx, edi
    mov     eax, edi
    sar     edx, 31
; EDX is 0xFFFFFFFF here if sign of input value is minus
; EDX is 0 if sign of input value is plus (including 0)
; the following two instructions have effect only if EDX is 0xFFFFFFFF
; or idle if EDX is 0
    xor     eax, edx
    sub     eax, edx
    ret
```

This is how it works:

Arithmetically shift the input value right by 31.

Arithmetical shift implies sign extension, so if the **MSB** is 1, all 32 bits are to be filled with 1, or with 0 if otherwise.

In other words, the SAR REG, 31 instruction makes 0xFFFFFFFF if the sign has been negative or 0 if positive.

After the execution of SAR, we have this value in EDX.

<sup>14</sup>High-Performance Computing

Then, if the value is 0xFFFFFFFF (i.e., the sign is negative), the input value is inverted (because XOR REG, 0xFFFFFFFF is effectively an inverse all bits operation).

Then, again, if the value is 0xFFFFFFFF (i.e., the sign is negative), 1 is added to the final result (because subtracting -1 from some value resulting in incrementing it).

Inversion of all bits and incrementing is exactly how two's complement value is negated: [2.2 on page 452](#).

We may observe that the last two instruction do something if the sign of the input value is negative.

Otherwise (if the sign is positive) they do nothing at all, leaving the input value untouched.

The algorithm is explained in [Henry S. Warren, *Hacker's Delight*, (2002)2-4].

It's hard to say, how GCC did it, deduced it by itself or found a suitable pattern among known ones?

### 3.16.2 Optimizing GCC 4.9 ARM64

GCC 4.9 for ARM64 generates mostly the same, just decides to use the full 64-bit registers.

There are less instructions, because the input value can be shifted using a suffixed instruction ("asr") instead of using a separate instruction.

Listing 3.59: Optimizing GCC 4.9 ARM64

```
my_abs:
; sign-extend input 32-bit value to X0 64-bit register:
    sxtw    x0, w0
    eor    x1, x0, x0, asr 63
; X1=X0^(X0>>63) (shift is arithmetical)
    sub    x0, x1, x0, asr 63
; X0=X1-(X0>>63)=X0^(X0>>63)-(X0>>63) (all shifts are arithmetical)
    ret
```

## 3.17 Variadic functions

Functions like `printf()` and `scanf()` can have a variable number of arguments. How are these arguments accessed?

### 3.17.1 Computing arithmetic mean

Let's imagine that we want to calculate [arithmetic mean](#), and for some weird reason we want to specify all the values as function arguments.

But it's impossible to get the number of arguments in a variadic function in C/C++, so let's denote the value of -1 as a terminator.

#### Using `va_arg` macro

There is the standard `stdarg.h` header file which define macros for dealing with such arguments.

The `printf()` and `scanf()` functions use them as well.

```
#include <stdio.h>
#include <stdarg.h>

int arith_mean(int v, ...)
{
    va_list args;
    int sum=v, count=1, i;
    va_start(args, v);

    while(1)
    {
        i=va_arg(args, int);
        if (i==-1) // terminator
            break;
        sum=sum+i;
        count++;
    }
}
```

```

    }

    va_end(args);
    return sum/count;
};

int main()
{
    printf ("%d\n", arith_mean (1, 2, 7, 10, 15, -1 /* terminator */));
};

```

The first argument has to be treated just like a normal argument.

All other arguments are loaded using the `va_arg` macro and then summed.

So what is inside?

### **cdecl** calling conventions

Listing 3.60: Optimizing MSVC 6.0

```

_v$ = 8
_arith_mean PROC NEAR
    mov     eax, DWORD PTR _v$[esp-4] ; load 1st argument into sum
    push   esi
    mov     esi, 1                    ; count=1
    lea    edx, DWORD PTR _v$[esp]   ; address of the 1st argument
$L838:
    mov     ecx, DWORD PTR [edx+4]    ; load next argument
    add     edx, 4                    ; shift pointer to the next argument
    cmp     ecx, -1                   ; is it -1?
    je     SHORT $L856                ; exit if so
    add     eax, ecx                   ; sum = sum + loaded argument
    inc     esi                       ; count++
    jmp    SHORT $L838
$L856:
; calculate quotient

    cdq
    idiv   esi
    pop    esi
    ret    0
_arith_mean ENDP

$SG851 DB     '%d', 0aH, 00H

_main PROC NEAR
    push   -1
    push   15
    push   10
    push   7
    push   2
    push   1
    call   _arith_mean
    push   eax
    push   OFFSET FLAT:$SG851 ; '%d'
    call   _printf
    add    esp, 32
    ret    0
_main ENDP

```

The arguments, as we may see, are passed to `main()` one-by-one.

The first argument is pushed into the local stack as first.

The terminating value (-1) is pushed last.

The `arith_mean()` function takes the value of the first argument and stores it in the `sum` variable.

Then, it sets the EDX register to the address of the second argument, takes the value from it, adds it to `sum`, and does this in an infinite loop, until -1 is found.

When it's found, the sum is divided by the number of all values (excluding -1) and the **quotient** is returned. So, in other words, the function treats the stack fragment as an array of integer values of infinite length. Now we can understand why the *cdecl* calling convention forces us to push the first argument into the stack as last.

Because otherwise, it would not be possible to find the first argument, or, for printf-like functions, it would not be possible to find the address of the format-string.

## Register-based calling conventions

The observant reader may ask, what about calling conventions where the first few arguments are passed in registers? Let's see:

Listing 3.61: Optimizing MSVC 2012 x64

```

$SG3013 DB      '%d', 0aH, 00H

v$ = 8
arith_mean PROC
    mov     DWORD PTR [rsp+8], ecx      ; 1st argument
    mov     QWORD PTR [rsp+16], rdx   ; 2nd argument
    mov     QWORD PTR [rsp+24], r8    ; 3rd argument
    mov     eax, ecx                  ; sum = 1st argument
    lea    rcx, QWORD PTR v$[rsp+8]  ; pointer to the 2nd argument
    mov     QWORD PTR [rsp+32], r9    ; 4th argument
    mov     edx, DWORD PTR [rcx]      ; load 2nd argument
    mov     r8d, 1                    ; count=1
    cmp     edx, -1                   ; 2nd argument is -1?
    je     SHORT $LN8@arith_mean     ; exit if so
$LL3@arith_mean:
    add     eax, edx                  ; sum = sum + loaded argument
    mov     edx, DWORD PTR [rcx+8]    ; load next argument
    lea    rcx, QWORD PTR [rcx+8]    ; shift pointer to point to the argument after next
    inc     r8d                       ; count++
    cmp     edx, -1                   ; is loaded argument -1?
    jne    SHORT $LL3@arith_mean     ; go to loop begin if its not
$LN8@arith_mean:
; calculate quotient
    cdq
    idiv   r8d
    ret    0
arith_mean ENDP

main PROC
    sub     rsp, 56
    mov     edx, 2
    mov     DWORD PTR [rsp+40], -1
    mov     DWORD PTR [rsp+32], 15
    lea    r9d, QWORD PTR [rdx+8]
    lea    r8d, QWORD PTR [rdx+5]
    lea    ecx, QWORD PTR [rdx-1]
    call   arith_mean
    lea    rcx, OFFSET FLAT:$SG3013
    mov     edx, eax
    call   printf
    xor     eax, eax
    add     rsp, 56
    ret    0
main ENDP

```

We see that the first 4 arguments are passed in the registers and two more—in the stack.

The `arith_mean()` function first places these 4 arguments into the *Shadow Space* and then treats the *Shadow Space* and stack behind it as a single continuous array!

What about GCC? Things are slightly clumsier here, because now the function is divided in two parts: the first part saves the registers into the “red zone”, processes that space, and the second part of the function processes the stack:

Listing 3.62: Optimizing GCC 4.9.1 x64

```

arith_mean:
    lea    rax, [rsp+8]
    ; save 6 input registers in
    ; red zone in the local stack
    mov    QWORD PTR [rsp-40], rsi
    mov    QWORD PTR [rsp-32], rdx
    mov    QWORD PTR [rsp-16], r8
    mov    QWORD PTR [rsp-24], rcx
    mov    esi, 8
    mov    QWORD PTR [rsp-64], rax
    lea    rax, [rsp-48]
    mov    QWORD PTR [rsp-8], r9
    mov    DWORD PTR [rsp-72], 8
    lea    rdx, [rsp+8]
    mov    r8d, 1
    mov    QWORD PTR [rsp-56], rax
    jmp    .L5

.L7:
    ; work out saved arguments
    lea    rax, [rsp-48]
    mov    ecx, esi
    add    esi, 8
    add    rcx, rax
    mov    ecx, DWORD PTR [rcx]
    cmp    ecx, -1
    je     .L4

.L8:
    add    edi, ecx
    add    r8d, 1

.L5:
    ; decide, which part we will work out now.
    ; is current argument number less or equal 6?
    cmp    esi, 47
    jbe    .L7          ; no, process saved arguments then
    ; work out arguments from stack
    mov    rcx, rdx
    add    rdx, 8
    mov    ecx, DWORD PTR [rcx]
    cmp    ecx, -1
    jne    .L8

.L4:
    mov    eax, edi
    cdq
    idiv  r8d
    ret

.LC1:
    .string "%d\n"
main:
    sub    rsp, 8
    mov    edx, 7
    mov    esi, 2
    mov    edi, 1
    mov    r9d, -1
    mov    r8d, 15
    mov    ecx, 10
    xor    eax, eax
    call  arith_mean
    mov    esi, OFFSET FLAT:.LC1
    mov    edx, eax
    mov    edi, 1
    xor    eax, eax
    add    rsp, 8
    jmp    __printf_chk

```

By the way, a similar usage of the *Shadow Space* is also considered here: [6.1.8 on page 741](#).

## Using pointer to the first function argument

The example can be rewritten without `va_arg` macro:

```
#include <stdio.h>

int arith_mean(int v, ...)
{
    int *i=&v;
    int sum=*i, count=1;
    i++;

    while(1)
    {
        if ((*i)==-1) // terminator
            break;
        sum=sum+(*i);
        count++;
        i++;
    }

    return sum/count;
};

int main()
{
    printf ("%d\n", arith_mean (1, 2, 7, 10, 15, -1 /* terminator */));
    // test: https://www.wolframalpha.com/input/?i=mean(1,2,7,10,15)
};
```

In other words, if an argument set is array of words (32-bit or 64-bit), we just enumerate array elements starting at first one.

### 3.17.2 `vprintf()` function case

Many programmers define their own logging functions which take a `printf`-like format string + a variable number of arguments.

Another popular example is the `die()` function, which prints some message and exits.

We need some way to pack input arguments of unknown number and pass them to the `printf()` function. But how?

That's why there are functions with "v" in name.

One of them is `vprintf()`: it takes a format-string and a pointer to a variable of type `va_list`:

```
#include <stdlib.h>
#include <stdarg.h>

void die (const char * fmt, ...)
{
    va_list va;
    va_start (va, fmt);

    vprintf (fmt, va);
    exit(0);
};
```

By closer examination, we can see that `va_list` is a pointer to an array. Let's compile:

Listing 3.63: Optimizing MSVC 2010

```
_fmt$ = 8
_die PROC
; load 1st argument (format-string)
mov     ecx, DWORD PTR _fmt$[esp-4]
; get pointer to the 2nd argument
lea    eax, DWORD PTR _fmt$[esp]
push   eax           ; pass a pointer
push   ecx
```



```

    call    _vprintf
    add     esp, 8
    push   0
    call    _exit
$LN3@die:
    int    3
_die     ENDP

```

We see that all our function does is just taking a pointer to the arguments and passing it to `vprintf()`, and that function is treating it like an infinite array of arguments!

Listing 3.64: Optimizing MSVC 2012 x64

```

fmt$ = 48
die    PROC
    ; save first 4 arguments in Shadow Space
    mov     QWORD PTR [rsp+8], rcx
    mov     QWORD PTR [rsp+16], rdx
    mov     QWORD PTR [rsp+24], r8
    mov     QWORD PTR [rsp+32], r9
    sub     rsp, 40
    lea     rdx, QWORD PTR fmt$[rsp+8] ; pass pointer to the 1st argument
    ; RCX here is still points to the 1st argument (format-string) of die()
    ; so vprintf() will take it right from RCX
    call    vprintf
    xor     ecx, ecx
    call    exit
    int    3
die    ENDP

```

### 3.17.3 Pin case

It's interesting to note how some functions from Pin [DBI<sup>15</sup>](#) framework takes number of arguments:

```

INS_InsertPredicatedCall(
    ins, IPOINT_BEFORE, (AFUNPTR)RecordMemRead,
    IARG_INST_PTR,
    IARG_MEMORYOP_EA, memOp,
    IARG_END);

```

( `pinatrace.cpp` )

And this is how `INS_InsertPredicatedCall()` function is declared:

```

extern VOID INS_InsertPredicatedCall(INS ins, IPOINT ipoint, AFUNPTR funptr, ...);

```

( `pin_client.PH` )

Hence, constants with names starting with `IARG_` are some kinds of arguments to the function, which are handled inside of `INS_InsertPredicatedCall()`. You can pass as many arguments, as you need. Some commands has additional argument(s), some are not. Full list of arguments: [https://software.intel.com/sites/landingpage/pintool/docs/58423/Pin/html/group\\_\\_INST\\_\\_ARGS.html](https://software.intel.com/sites/landingpage/pintool/docs/58423/Pin/html/group__INST__ARGS.html). And it has to be a way to detect an end of arguments list, so the list must be terminated with `IARG_END` constant, without which, the function will (try to) handle random noise in the local stack, treating it as additional arguments.

Also, in [Brian W. Kernighan, Rob Pike, *Practice of Programming*, (1999)] we can find a nice example of C/C++ routines very similar to `pack/unpack16` in Python.

### 3.17.4 Format string exploit

It's a popular mistake, to write `printf(string)` instead of `puts(string)` or `printf("%s", string)`. If the attacker can put his/her own text into `string`, he/she can crash process, or get insight into variables in the local stack.

<sup>15</sup>Dynamic Binary Instrumentation

<sup>16</sup><https://docs.python.org/3/library/struct.html>

Take a look at this:

```
#include <stdio.h>

int main()
{
    char *s1="hello";
    char *s2="world";
    char buf[128];

    // do something mundane here
    strcpy (buf, s1);
    strcpy (buf, " ");
    strcpy (buf, s2);

    printf ("%s");
};
```

Please note, that `printf()` has no additional arguments besides single format string.

Now let's imagine, that was the attacker who put `%s` string into the last `printf()` first arguments. I compile this example using GCC 5.4.0 on x86 Ubuntu, and the resulting executable prints "world" string if it gets executed!

If I turn optimization on, `printf()` outputs some garbage, though—probably, `strcpy()` calls has been optimized and/or local variables as well. Also, result will be different for x64 code, different compiler, OS, etc.

Now, let's say, attacker could pass the following string to `printf()` call: `%x %x %x %x %x`. In may case, output is: "80485c6 b7751b48 1 0 80485c0" (these are just values from local stack). You see, there are 1 and 0 values, and some pointers (first is probably pointer to "world" string). So if the attacker passes `%s %s %s %s` string, the process will crash, because `printf()` treats 1 and/or 0 as pointer to string, tries to read characters from there and fails.

Even worse, there could be `sprintf (buf, string)` in code, where `buf` is a buffer in the local stack with size of 1024 bytes or so, attacker can craft string in such a way that `buf` will be overflown, maybe even in a way that would lead to code execution.

Many popular and well-known software was (or even still) vulnerable:

```
QuakeWorld went up, got to around 4000 users, then the master server exploded.
Disrupter and cohorts are working on more robust code now.
If anyone did it on purpose, how about letting us know... (It wasn't all the people that
tried %s as a name)
```

( John Carmack's .plan file, 17-Dec-1996<sup>17</sup> )

Nowadays, almost all decent compilers warn about this.

Another problem is the lesser known `%n` `printf()` argument: whenever `printf()` reaches it in a format string, it writes the number of characters printed so far into the corresponding argument: <http://stackoverflow.com/questions/3401156/what-is-the-use-of-the-n-format-specifier-in-c>. Thus, an attacker could zap local variables by passing many `%n` commands in format string.

## 3.18 Strings trimming

A very common string processing task is to remove some characters at the start and/or at the end.

In this example, we are going to work with a function which removes all newline characters ([CR](#)<sup>18</sup>/[LF](#)<sup>19</sup>) from the end of the input string:

```
#include <stdio.h>
#include <string.h>
```

<sup>17</sup>[https://github.com/ESWAT/john-carmack-plan-archive/blob/33ae52fdb46aa0d1abfed6fc7598233748541c0/by\\_day/johnc\\_plan\\_19961217.txt](https://github.com/ESWAT/john-carmack-plan-archive/blob/33ae52fdb46aa0d1abfed6fc7598233748541c0/by_day/johnc_plan_19961217.txt)

<sup>18</sup>Carriage Return (13 or '\r' in C/C++)

<sup>19</sup>Line Feed (10 or '\n' in C/C++)

```

char* str_trim (char *s)
{
    char c;
    size_t str_len;

    // work as long as \r or \n is at the end of string
    // stop if some other character there or its an empty string
    // (at start or due to our operation)
    for (str_len=strlen(s); str_len>0 && (c=s[str_len-1]); str_len--)
    {
        if (c=='\r' || c=='\n')
            s[str_len-1]=0;
        else
            break;
    };
    return s;
};

int main()
{
    // test

    // strdup() is used to copy text string into data segment,
    // because it will crash on Linux otherwise,
    // where text strings are allocated in constant data segment,
    // and not modifiable.

    printf ("%s\n", str_trim (strdup("")));
    printf ("%s\n", str_trim (strdup("\n")));
    printf ("%s\n", str_trim (strdup("\r")));
    printf ("%s\n", str_trim (strdup("\n\r")));
    printf ("%s\n", str_trim (strdup("\r\n")));
    printf ("%s\n", str_trim (strdup("test1\r\n")));
    printf ("%s\n", str_trim (strdup("test2\n\r")));
    printf ("%s\n", str_trim (strdup("test3\n\r\n\r")));
    printf ("%s\n", str_trim (strdup("test4\n")));
    printf ("%s\n", str_trim (strdup("test5\r")));
    printf ("%s\n", str_trim (strdup("test6\r\r\r")));
};

```

The input argument is always returned on exit, this is convenient when you want to chain string processing functions, like it has done here in the main() function.

The second part of for() (str\_len>0 && (c=s[str\_len-1])) is the so called “short-circuit” in C/C++ and is very convenient [Dennis Yurichev, *C/C++ programming language notes*1.3.8].

The C/C++ compilers guarantee an evaluation sequence from left to right.

So if the first clause is false after evaluation, the second one is never to be evaluated.

### 3.18.1 x64: Optimizing MSVC 2013

Listing 3.65: Optimizing MSVC 2013 x64

```

s$ = 8
str_trim PROC

; RCX is the first function argument and it always holds pointer to the string
    mov     rdx, rcx
; this is strlen() function inlined right here:
; set RAX to 0xFFFFFFFFFFFFFFFF (-1)
    or     rax, -1
$LL14@str_trim:
    inc     rax
    cmp     BYTE PTR [rcx+rax], 0
    jne     SHORT $LL14@str_trim
; is the input string length zero? exit then:
    test    rax, rax
    je     SHORT $LN15@str_trim
; RAX holds string length

```

```

    dec    rcx
; RCX = s-1
    mov    r8d, 1
    add    rcx, rax
; RCX = s-1+strlen(s), i.e., this is the address of the last character in the string
    sub    r8, rdx
; R8 = 1-s
$LL6@str_trim:
; load the last character of the string:
; jump, if its code is 13 or 10:
    movzx  eax, BYTE PTR [rcx]
    cmp    al, 13
    je     SHORT $LN2@str_trim
    cmp    al, 10
    jne    SHORT $LN15@str_trim
$LN2@str_trim:
; the last character has a 13 or 10 code
; write zero at this place:
    mov    BYTE PTR [rcx], 0
; decrement address of the last character,
; so it will point to the character before the one which has just been erased:
    dec    rcx
    lea    rax, QWORD PTR [r8+rcx]
; RAX = 1 - s + address of the current last character
; thus we can determine if we reached the first character and we need to stop, if it is so
    test   rax, rax
    jne    SHORT $LL6@str_trim
$LN15@str_trim:
    mov    rax, rdx
    ret    0
str_trim ENDP

```

First, MSVC inlined the `strlen()` function code, because it concluded this is to be faster than the usual `strlen()` work + the cost of calling it and returning from it. This is called inlining: [3.14 on page 510](#).

The first instruction of the inlined `strlen()` is  
`OR RAX, 0xFFFFFFFFFFFFFFFF`.

MSVC often uses `OR` instead of `MOV RAX, 0xFFFFFFFFFFFFFFFF`, because resulting opcode is shorter.

And of course, it is equivalent: all bits are set, and a number with all bits set is `-1` in two's complement arithmetic: [2.2 on page 452](#).

Why would the `-1` number be used in `strlen()`, one might ask. Due to optimizations, of course. Here is the code that MSVC generated:

Listing 3.66: Inlined `strlen()` by MSVC 2013 x64

```

; RCX = pointer to the input string
; RAX = current string length
    or     rax, -1
label:
    inc    rax
    cmp    BYTE PTR [rcx+rax], 0
    jne    SHORT label
; RAX = string length

```

Try to write shorter if you want to initialize the counter at 0! OK, let' try:

Listing 3.67: Our version of `strlen()`

```

; RCX = pointer to the input string
; RAX = current string length
    xor    rax, rax
label:
    cmp    byte ptr [rcx+rax], 0
    jz     exit
    inc    rax
    jmp    label
exit:
; RAX = string length

```

We failed. We have to use additional JMP instruction!

So what the MSVC 2013 compiler did is to move the INC instruction to the place before the actual character loading.

If the first character is 0, that's OK, RAX is 0 at this moment, so the resulting string length is 0.

The rest in this function seems easy to understand.

### 3.18.2 x64: Non-optimizing GCC 4.9.1

```
str_trim:
    push    rbp
    mov     rbp, rsp
    sub     rsp, 32
    mov     QWORD PTR [rbp-24], rdi
; for() first part begins here
    mov     rax, QWORD PTR [rbp-24]
    mov     rdi, rax
    call    strlen
    mov     QWORD PTR [rbp-8], rax    ; str_len
; for() first part ends here
    jmp     .L2
; for() body begins here
.L5:
    cmp     BYTE PTR [rbp-9], 13    ; c=='\r'?
    je     .L3
    cmp     BYTE PTR [rbp-9], 10    ; c=='\n'?
    jne    .L4
.L3:
    mov     rax, QWORD PTR [rbp-8]    ; str_len
    lea    rdx, [rax-1]              ; EDX=str_len-1
    mov     rax, QWORD PTR [rbp-24]    ; s
    add    rax, rdx                  ; RAX=s+str_len-1
    mov     BYTE PTR [rax], 0        ; s[str_len-1]=0
; for() body ends here
; for() third part begins here
    sub     QWORD PTR [rbp-8], 1    ; str_len--
; for() third part ends here
.L2:
; for() second part begins here
    cmp     QWORD PTR [rbp-8], 0    ; str_len==0?
    je     .L4                      ; exit then
; check second clause, and load "c"
    mov     rax, QWORD PTR [rbp-8]    ; RAX=str_len
    lea    rdx, [rax-1]              ; RDX=str_len-1
    mov     rax, QWORD PTR [rbp-24]    ; RAX=s
    add    rax, rdx                  ; RAX=s+str_len-1
    movzx  eax, BYTE PTR [rax]        ; AL=s[str_len-1]
    mov     BYTE PTR [rbp-9], al     ; store loaded char into "c"
    cmp     BYTE PTR [rbp-9], 0      ; is it zero?
    jne    .L5                      ; yes? exit then
; for() second part ends here
.L4:
; return "s"
    mov     rax, QWORD PTR [rbp-24]
    leave
    ret
```

Comments are added by the author of the book.

After the execution of `strlen()`, the control is passed to the L2 label, and there two clauses are checked, one after another.

The second will never be checked, if the first one (`str_len==0`) is false (this is “short-circuit”).

Now let's see this function in short form:

- First for() part (call to `strlen()`)
- goto L2

- L5: for() body. goto exit, if needed
- for() third part (decrement of str\_len)
- L2: for() second part: check first clause, then second. goto loop body begin or exit.
- L4: // exit
- return s

### 3.18.3 x64: Optimizing GCC 4.9.1

```

str_trim:
    push    rbx
    mov     rbx, rdi
; RBX will always be "s"
    call   strlen
; check for str_len==0 and exit if its so
    test   rax, rax
    je     .L9
    lea    rdx, [rax-1]
; RDX will always contain str_len-1 value, not str_len
; so RDX is more like buffer index variable
    lea    rsi, [rbx+rdx] ; RSI=s+str_len-1
    movzx ecx, BYTE PTR [rsi] ; load character
    test   cl, cl
    je     .L9 ; exit if its zero
    cmp    cl, 10
    je     .L4
    cmp    cl, 13 ; exit if its not '\n' and not '\r'
    jne    .L9
.L4:
; this is weird instruction. we need RSI=s-1 here.
; its possible to get it by MOV RSI, EBX / DEC RSI
; but this is two instructions instead of one
    sub    rsi, rax
; RSI = s+str_len-1-str_len = s-1
; main loop begin
.L12:
    test   rdx, rdx
; store zero at address s-1+str_len-1+1 = s-1+str_len = s+str_len-1
    mov    BYTE PTR [rsi+1+rdx], 0
; check for str_len-1==0. exit if so.
    je     .L9
    sub    rdx, 1 ; equivalent to str_len--
; load next character at address s+str_len-1
    movzx ecx, BYTE PTR [rbx+rdx]
    test   cl, cl ; is it zero? exit then
    je     .L9
    cmp    cl, 10 ; is it '\n'?
    je     .L12
    cmp    cl, 13 ; is it '\r'?
    je     .L12
.L9:
; return "s"
    mov    rax, rbx
    pop    rbx
    ret

```

Now this is more complex.

The code before the loop's body start is executed only once, but it has the [CR/LF](#) characters check too! What is this code duplication for?

The common way to implement the main loop is probably this:

- (loop start) check for [CR/LF](#) characters, make decisions
- store zero character

But GCC has decided to reverse these two steps.

Of course, *store zero character* cannot be first step, so another check is needed:

- workout first character. match it to CR/LF, exit if character is not CR/LF
- (loop begin) store zero character
- check for CR/LF characters, make decisions

Now the main loop is very short, which is good for latest CPUs.

The code doesn't use the str\_len variable, but str\_len-1. So this is more like an index in a buffer.

Apparently, GCC notices that the str\_len-1 statement is used twice.

So it's better to allocate a variable which always holds a value that's smaller than the current string length by one, and decrement it (this is the same effect as decrementing the str\_len variable).

### 3.18.4 ARM64: Non-optimizing GCC (Linaro) 4.9

This implementation is straightforward:

Listing 3.68: Non-optimizing GCC (Linaro) 4.9

```

str_trim:
    stp    x29, x30, [sp, -48]!
    add   x29, sp, 0
    str   x0, [x29,24] ; copy input argument into local stack
    ldr   x0, [x29,24] ; s
    bl   strlen
    str   x0, [x29,40] ; str_len variable in local stack
    b    .L2
; main loop begin
.L5:
    ldrb  w0, [x29,39]
; W0=c
    cmp  w0, 13      ; is it '\r'?
    beq  .L3
    ldrb  w0, [x29,39]
; W0=c
    cmp  w0, 10      ; is it '\n'?
    bne  .L4        ; goto exit if it is not
.L3:
    ldr   x0, [x29,40]
; X0=str_len
    sub  x0, x0, #1
; X0=str_len-1
    ldr   x1, [x29,24]
; X1=s
    add  x0, x1, x0
; X0=s+str_len-1
    strb wzr, [x0]   ; write byte at s+str_len-1
; decrement str_len:
    ldr   x0, [x29,40]
; X0=str_len
    sub  x0, x0, #1
; X0=str_len-1
    str  x0, [x29,40]
; save X0 (or str_len-1) to local stack
.L2:
    ldr   x0, [x29,40]
; str_len==0?
    cmp  x0, xzr
; goto exit then
    beq  .L4
    ldr   x0, [x29,40]
; X0=str_len
    sub  x0, x0, #1
; X0=str_len-1
    ldr   x1, [x29,24]
; X1=s
    add  x0, x1, x0
; X0=s+str_len-1
; load byte at address s+str_len-1 to W0
    ldrb w0, [x0]

```

```

        strb    w0, [x29,39] ; store loaded byte to "c"
        ldrb    w0, [x29,39] ; reload it
; is it zero byte?
        cmp     w0, wzr
; goto exit, if its zero or to L5 if its not
        bne    .L5
.L4:
; return s
        ldr     x0, [x29,24]
        ldp     x29, x30, [sp], 48
        ret

```

### 3.18.5 ARM64: Optimizing GCC (Linaro) 4.9

This is a more advanced optimization.

The first character is loaded at the beginning, and compared against 10 (the LF character).

Characters are also loaded in the main loop, for the characters after first one.

This is somewhat similar to the [3.18.3 on page 532](#) example.

Listing 3.69: Optimizing GCC (Linaro) 4.9

```

str_trim:
        stp     x29, x30, [sp, -32]!
        add    x29, sp, 0
        str     x19, [sp,16]
        mov    x19, x0
; X19 will always hold value of "s"
        bl     strlen
; X0=str_len
        cbz    x0, .L9          ; goto L9 (exit) if str_len==0
        sub    x1, x0, #1
; X1=X0-1=str_len-1
        add    x3, x19, x1
; X3=X19+X1=s+str_len-1
        ldrb   w2, [x19,x1]    ; load byte at address X19+X1=s+str_len-1
; W2=loaded character
        cbz    w2, .L9          ; is it zero? jump to exit then
        cmp    w2, 10          ; is it '\n'?
        bne    .L15
.L12:
; main loop body. loaded character is always 10 or 13 at this moment!
        sub    x2, x1, x0
; X2=X1-X0=str_len-1-str_len=-1
        add    x2, x3, x2
; X2=X3+X2=s+str_len-1+(-1)=s+str_len-2
        strb   wzr, [x2,1]    ; store zero byte at address s+str_len-2+1=s+str_len-1
        cbz    x1, .L9          ; str_len-1==0? goto exit, if so
        sub    x1, x1, #1      ; str_len--
        ldrb   w2, [x19,x1]    ; load next character at address X19+X1=s+str_len-1
        cmp    w2, 10          ; is it '\n'?
        cbz    w2, .L9          ; jump to exit, if its zero
        beq    .L12           ; jump to begin loop, if its '\n'
.L15:
        cmp    w2, 13          ; is it '\r'?
        beq    .L12           ; yes, jump to the loop body begin
.L9:
; return "s"
        mov    x0, x19
        ldr    x19, [sp,16]
        ldp    x29, x30, [sp], 32
        ret

```

### 3.18.6 ARM: Optimizing Keil 6/2013 (ARM mode)

And again, the compiler took advantage of ARM mode's conditional instructions, so the code is much more compact.



Listing 3.70: Optimizing Keil 6/2013 (ARM mode)

```

str_trim PROC
    PUSH    {r4,lr}
; R0=s
    MOV     r4,r0
; R4=s
    BL     strlen      ; strlen() takes "s" value from R0
; R0=str_len
    MOV     r3,#0
; R3 will always hold 0
|L0.16|
    CMP     r0,#0      ; str_len==0?
    ADDNE  r2,r4,r0    ; (if str_len!=0) R2=R4+R0=s+str_len
    LDRBNE r1,[r2,#-1] ; (if str_len!=0) R1=load byte at address R2-1=s+str_len-1
    CMPNE  r1,#0      ; (if str_len!=0) compare loaded byte against 0
    BEQ    |L0.56|     ; jump to exit if str_len==0 or loaded byte is 0
    CMP    r1,#0xd     ; is loaded byte '\r'?
    CMPNE  r1,#0xa     ; (if loaded byte is not '\r') is loaded byte '\r'?
    SUBEQ  r0,r0,#1    ; (if loaded byte is '\r' or '\n') R0-- or str_len--
    STRBEQ r3,[r2,#-1] ; (if loaded byte is '\r' or '\n') store R3 (zero) at address
    R2-1=s+str_len-1
    BEQ    |L0.16|     ; jump to loop begin if loaded byte was '\r' or '\n'
|L0.56|
; return "s"
    MOV     r0,r4
    POP     {r4,pc}
    ENDP

```

### 3.18.7 ARM: Optimizing Keil 6/2013 (Thumb mode)

There are less conditional instructions in Thumb mode, so the code is simpler.

But there are is really weird thing with the 0x20 and 0x1F offsets (lines 22 and 23). Why did the Keil compiler do so? Honestly, it's hard to say.

It has to be a quirk of Keil's optimization process. Nevertheless, the code works correctly.

Listing 3.71: Optimizing Keil 6/2013 (Thumb mode)

```

1 str_trim PROC
2     PUSH    {r4,lr}
3     MOVS    r4,r0
4 ; R4=s
5     BL     strlen      ; strlen() takes "s" value from R0
6 ; R0=str_len
7     MOVS    r3,#0
8 ; R3 will always hold 0
9     B      |L0.24|
10 |L0.12|
11     CMP    r1,#0xd     ; is loaded byte '\r'?
12     BEQ    |L0.20|
13     CMP    r1,#0xa     ; is loaded byte '\n'?
14     BNE    |L0.38|     ; jump to exit, if no
15 |L0.20|
16     SUBS    r0,r0,#1    ; R0-- or str_len--
17     STRB   r3,[r2,#0x1f] ; store 0 at address R2+0x1F=s+str_len-0x20+0x1F=s+str_len-1
18 |L0.24|
19     CMP    r0,#0      ; str_len==0?
20     BEQ    |L0.38|     ; yes? jump to exit
21     ADDS    r2,r4,r0    ; R2=R4+R0=s+str_len
22     SUBS    r2,r2,#0x20 ; R2=R2-0x20=s+str_len-0x20
23     LDRB   r1,[r2,#0x1f] ; load byte at address R2+0x1F=s+str_len-0x20+0x1F=s+str_len-1 to
    R1
24     CMP    r1,#0      ; is loaded byte 0?
25     BNE    |L0.12|     ; jump to loop begin, if its not 0
26 |L0.38|
27 ; return "s"
28     MOVS    r0,r4
29     POP     {r4,pc}
30     ENDP

```

### 3.18.8 MIPS

Listing 3.72: Optimizing GCC 4.4.5 (IDA)

```
str_trim:
; IDA is not aware of local variable names, we gave them manually:
saved_GP      = -0x10
saved_S0      = -8
saved_RA      = -4

        lui    $gp, (__gnu_local_gp >> 16)
        addiu $sp, -0x20
        la    $gp, (__gnu_local_gp & 0xFFFF)
        sw    $ra, 0x20+saved_RA($sp)
        sw    $s0, 0x20+saved_S0($sp)
        sw    $gp, 0x20+saved_GP($sp)
; call strlen(). input string address is still in $a0, strlen() will take it from there:
        lw    $t9, (strlen & 0xFFFF)($gp)
        or    $at, $zero ; load delay slot, NOP
        jalr $t9
; input string address is still in $a0, put it to $s0:
        move  $s0, $a0 ; branch delay slot
; result of strlen() (i.e. length of string) is in $v0 now
; jump to exit if $v0==0 (i.e., if length of string is 0):
        beqz $v0, exit
        or    $at, $zero ; branch delay slot, NOP
        addiu $a1, $v0, -1
; $a1 = $v0-1 = str_len-1
        addu  $a1, $s0, $a1
; $a1 = input string address + $a1 = s+strlen-1
; load byte at address $a1:
        lb    $a0, 0($a1)
        or    $at, $zero ; load delay slot, NOP
; loaded byte is zero? jump to exit if its so:
        beqz $a0, exit
        or    $at, $zero ; branch delay slot, NOP
        addiu $v1, $v0, -2
; $v1 = str_len-2
        addu  $v1, $s0, $v1
; $v1 = $s0+$v1 = s+str_len-2
        li    $a2, 0xD
; skip loop body:
        b     loc_6C
        li    $a3, 0xA ; branch delay slot
loc_5C:
; load next byte from memory to $a0:
        lb    $a0, 0($v1)
        move  $a1, $v1
; $a1=s+str_len-2
; jump to exit if loaded byte is zero:
        beqz $a0, exit
; decrement str_len:
        addiu $v1, -1 ; branch delay slot
loc_6C:
; at this moment, $a0=loaded byte, $a2=0xD (CR symbol) and $a3=0xA (LF symbol)
; loaded byte is CR? jump to loc_7C then:
        beq  $a0, $a2, loc_7C
        addiu $v0, -1 ; branch delay slot
; loaded byte is LF? jump to exit if its not LF:
        bne  $a0, $a3, exit
        or    $at, $zero ; branch delay slot, NOP
loc_7C:
; loaded byte is CR at this moment
; jump to loc_5c (loop body begin) if str_len (in $v0) is not zero:
        bnez $v0, loc_5C
; simultaneously, store zero at that place in memory:
        sb   $zero, 0($a1) ; branch delay slot
; "exit" label was named by me manually:
exit:
        lw    $ra, 0x20+saved_RA($sp)
        move  $v0, $s0
```

```
lw    $s0, 0x20+saved_S0($sp)
jr    $ra
addiu $sp, 0x20    ; branch delay slot
```

Registers prefixed with S- are also called “saved temporaries”, so \$S0 value is saved in the local stack and restored upon finish.

### 3.19 toupper() function

Another very popular function transforms a symbol from lower case to upper case, if needed:

```
char toupper (char c)
{
    if(c>='a' && c<='z')
        return c-'a'+'A';
    else
        return c;
}
```

The 'a'+'A' expression is left in the source code for better readability, it will be optimized by compiler, of course <sup>20</sup>.

The [ASCII](#) code of “a” is 97 (or 0x61), and 65 (or 0x41) for “A”.

The difference (or distance) between them in the [ASCII](#) table is 32 (or 0x20).

For better understanding, the reader may take a look at the 7-bit standard [ASCII](#) table:

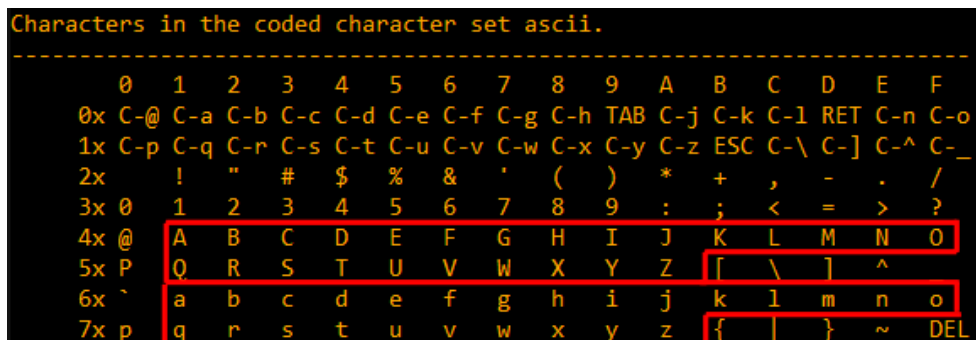

Figure 3.3: 7-bit [ASCII](#) table in Emacs

#### 3.19.1 x64

##### Two comparison operations

Non-optimizing MSVC is straightforward: the code checks if the input symbol is in [97..122] range (or in ['a'..'z'] range) and subtracts 32 if it's true.

There are also some minor compiler artifact:

Listing 3.73: Non-optimizing MSVC 2013 (x64)

```
1  c$ = 8
2  toupper PROC
3      mov     BYTE PTR [rsp+8], cl
4      movsx  eax, BYTE PTR c$[rsp]
5      cmp    eax, 97
6      jl    SHORT $LN2@toupper
7      movsx  eax, BYTE PTR c$[rsp]
8      cmp    eax, 122
9      jg    SHORT $LN2@toupper
10     movsx  eax, BYTE PTR c$[rsp]
11     sub    eax, 32
12     jmp    SHORT $LN3@toupper
13     jmp    SHORT $LN1@toupper    ; compiler artefact
```

<sup>20</sup>However, to be meticulous, there still could be compilers which can't optimize such expressions and will leave them right in the code.

```

14 $LN2@toupper:
15     movzx    eax, BYTE PTR c$[rsp]    ; unnecessary casting
16 $LN1@toupper:
17 $LN3@toupper:                          ; compiler artefact
18     ret     0
19 toupper ENDP

```

It's important to notice that the input byte is loaded into a 64-bit local stack slot at line 3.

All the remaining bits ([8..63]) are untouched, i.e., contain some random noise (you'll see it in debugger).

All instructions operate only on byte-level, so it's fine.

The last MOVZX instruction at line 15 takes the byte from the local stack slot and zero-extends it to a *int* 32-bit data type.

Non-optimizing GCC does mostly the same:

Listing 3.74: Non-optimizing GCC 4.9 (x64)

```

toupper:
    push    rbp
    mov     rbp, rsp
    mov     eax, edi
    mov     BYTE PTR [rbp-4], al
    cmp     BYTE PTR [rbp-4], 96
    jle    .L2
    cmp     BYTE PTR [rbp-4], 122
    jg     .L2
    movzx   eax, BYTE PTR [rbp-4]
    sub     eax, 32
    jmp    .L3
.L2:
    movzx   eax, BYTE PTR [rbp-4]
.L3:
    pop     rbp
    ret

```

### One comparison operation

Optimizing MSVC does a better job, it generates only one comparison operation:

Listing 3.75: Optimizing MSVC 2013 (x64)

```

toupper PROC
    lea     eax, DWORD PTR [rcx-97]
    cmp     al, 25
    ja     SHORT $LN2@toupper
    movsx   eax, cl
    sub     eax, 32
    ret     0
$LN2@toupper:
    movzx   eax, cl
    ret     0
toupper ENDP

```

It was explained earlier how to replace the two comparison operations with a single one: [3.13.2 on page 509](#).

We will now rewrite this in C/C++:

```

int tmp=c-97;
if (tmp>25)
    return c;
else
    return c-32;

```

The *tmp* variable must be signed.

This makes two subtraction operations in case of a transformation plus one comparison.

In contrast the original algorithm uses two comparison operations plus one subtracting.

Optimizing GCC is even better, it gets rid of the jumps (which is good: [2.10.1 on page 466](#)) by using the CMOVcc instruction:

Listing 3.76: Optimizing GCC 4.9 (x64)

```
1 toupper:
2     lea    edx, [rdi-97] ; 0x61
3     lea    eax, [rdi-32] ; 0x20
4     cmp    dl, 25
5     cmova  eax, edi
6     ret
```

At line 3 the code prepares the subtracted value in advance, as if the conversion will always happen.

At line 5 the subtracted value in EAX is replaced by the untouched input value if a conversion is not needed. And then this value (of course incorrect) is dropped.

Advance subtracting is a price the compiler pays for the absence of conditional jumps.

### 3.19.2 ARM

Optimizing Keil for ARM mode also generates only one comparison:

Listing 3.77: Optimizing Keil 6/2013 (ARM mode)

```
toupper PROC
    SUB    r1, r0, #0x61
    CMP    r1, #0x19
    SUBLS  r0, r0, #0x20
    ANDLS  r0, r0, #0xff
    BX    lr
ENDP
```

The SUBLS and ANDLS instructions are executed only if the value in R1 is less than 0x19 (or equal). They also do the actual conversion.

Optimizing Keil for Thumb mode generates only one comparison operation as well:

Listing 3.78: Optimizing Keil 6/2013 (Thumb mode)

```
toupper PROC
    MOVS   r1, r0
    SUBS   r1, r1, #0x61
    CMP    r1, #0x19
    BHI    |L0.14|
    SUBS   r0, r0, #0x20
    LSLS   r0, r0, #24
    LSRS   r0, r0, #24
|L0.14|
    BX    lr
ENDP
```

The last two LSLS and LSRS instructions work like AND reg, 0xFF: they are equivalent to the C/C++-expression  $(i \ll 24) \gg 24$ .

Seems like that Keil for Thumb mode deduced that two 2-byte instructions are shorter than the code that loads the 0xFF constant into a register plus an AND instruction.

### GCC for ARM64

Listing 3.79: Non-optimizing GCC 4.9 (ARM64)

```
toupper:
    sub    sp, sp, #16
    strb   w0, [sp,15]
    ldrb   w0, [sp,15]
```

```

    cmp    w0, 96
    bls    .L2
    ldrb   w0, [sp,15]
    cmp    w0, 122
    bhi    .L2
    ldrb   w0, [sp,15]
    sub    w0, w0, #32
    uxtb   w0, w0
    b      .L3
.L2:
    ldrb   w0, [sp,15]
.L3:
    add    sp, sp, 16
    ret

```

Listing 3.80: Optimizing GCC 4.9 (ARM64)

```

toupper:
    uxtb   w0, w0
    sub    w1, w0, #97
    uxtb   w1, w1
    cmp    w1, 25
    bhi    .L2
    sub    w0, w0, #32
    uxtb   w0, w0
.L2:
    ret

```

### 3.19.3 Using bit operations

Given the fact that 5th bit (counting from 0th) is always present after the check, subtracting is merely clearing this sole bit, but the very same effect can be achieved with ANDing ( [2.5 on page 458](#)).

Even simpler, with XOR-ing:

```

char toupper (char c)
{
    if(c>='a' && c<='z')
        return c^0x20;
    else
        return c;
}

```

The code is close to what the optimized GCC has produced for the previous example ( [3.76 on the preceding page](#)):

Listing 3.81: Optimizing GCC 5.4 (x86)

```

toupper:
    mov    edx, DWORD PTR [esp+4]
    lea   ecx, [edx-97]
    mov   eax, edx
    xor   eax, 32
    cmp   cl, 25
    cmova eax, edx
    ret

```

...but XOR is used instead of SUB.

Flipping 5th bit is just moving a *cursor* in [ASCII](#) table up and down by two rows.

Some people say that lowercase/uppercase letters has been placed in the [ASCII](#) table in such a way deliberately, because:

Very old keyboards used to do Shift just by toggling the 32 or 16 bit, depending on the key; this is why the relationship between small and capital letters in ASCII is so regular, and the relationship between numbers and symbols, and some pairs of symbols, is sort of regular if you squint at it.

( Eric S. Raymond, <http://www.catb.org/esr/faqs/things-every-hacker-once-knew/> )

Therefore, we can write this piece of code, which just flips the case of letters:

```
#include <stdio.h>

char flip (char c)
{
    if((c>='a' && c<='z') || (c>='A' && c<='Z'))
        return c^0x20;
    else
        return c;
}

int main()
{
    // will produce "hELLO, WORLD!"
    for (char *s="Hello, world!"; *s; s++)
        printf ("%c", flip(*s));
};
```

### 3.19.4 Summary

All these compiler optimizations are very popular nowadays and a practicing reverse engineer usually sees such code patterns often.

## 3.20 Obfuscation

The obfuscation is an attempt to hide the code (or its meaning) from reverse engineers.

### 3.20.1 Text strings

As we know from ( [5.4 on page 707](#) ), text strings may be really helpful.

Programmers who are aware of this try to hide them, making it impossible to find the string in [IDA](#) or any hex editor.

Here is the simplest method.

This is how the string can be constructed:

```
mov     byte ptr [ebx], 'h'
mov     byte ptr [ebx+1], 'e'
mov     byte ptr [ebx+2], 'l'
mov     byte ptr [ebx+3], 'l'
mov     byte ptr [ebx+4], 'o'
mov     byte ptr [ebx+5], ' '
mov     byte ptr [ebx+6], 'w'
mov     byte ptr [ebx+7], 'o'
mov     byte ptr [ebx+8], 'r'
mov     byte ptr [ebx+9], 'l'
mov     byte ptr [ebx+10], 'd'
```

The string can also be compared with another one like this:

```
mov     ebx, offset username
cmp     byte ptr [ebx], 'j'
jnz     fail
cmp     byte ptr [ebx+1], 'o'
jnz     fail
cmp     byte ptr [ebx+2], 'h'
jnz     fail
cmp     byte ptr [ebx+3], 'n'
jnz     fail
jz      it_is_john
```

In both cases, it is impossible to find these strings straightforwardly in a hex editor.

By the way, this is a way to work with the strings when it is impossible to allocate space for them in the data segment, for example in a PIC<sup>21</sup> or in shellcode.

Another method is to use `sprintf()` for the construction:

```
sprintf(buf, "%S%C%S%C%S", "hel", 'l', "o w", 'o', "rld");
```

The code looks weird, but as a simple anti-reversing measure, it may be helpful.

Text strings may also be present in encrypted form, then every string usage is to be preceded by a string decrypting routine. For example: [8.8.2 on page 837](#).

## 3.20.2 Executable code

### Inserting garbage

Executable code obfuscation implies inserting random garbage code between real one, which executes but does nothing useful.

A simple example:

Listing 3.82: original code

```
add    eax, ebx
mul    ecx
```

Listing 3.83: obfuscated code

```
xor    esi, 011223344h ; garbage
add    esi, eax        ; garbage
add    eax, ebx
mov    edx, eax        ; garbage
shl    edx, 4          ; garbage
mul    ecx
xor    esi, ecx        ; garbage
```

Here the garbage code uses registers which are not used in the real code (ESI and EDX). However, the intermediate results produced by the real code may be used by the garbage instructions for some extra mess—why not?

### Replacing instructions with bloated equivalents

- `MOV op1, op2` can be replaced by the `PUSH op2 / POP op1` pair.
- `JMP label` can be replaced by the `PUSH label / RET` pair. *IDA* will not show the references to the label.
- `CALL label` can be replaced by the following instructions triplet:  
`PUSH label_after_CALL_instruction / PUSH label / RET`.
- `PUSH op` can also be replaced with the following instructions pair:  
`SUB ESP, 4 (or 8) / MOV [ESP], op`.

### Always executed/never executed code

If the developer is sure that ESI is always 0 at that point:

```
mov    esi, 1
...    ; some code not touching ESI
dec    esi
...    ; some code not touching ESI
cmp    esi, 0
jz     real_code
; fake luggage
real_code:
```

<sup>21</sup>Position Independent Code



The reverse engineer needs some time to get into it.

This is also called an *opaque predicate*.

Another example (and again, the developer is sure that ESI is always zero):

```
; ESI=0
add    eax, ebx    ; real code
mul    ecx         ; real code
add    eax, esi    ; opaque predicate. XOR, AND or SHL, etc, can be here instead of ADD.
```

## Making a lot of mess

```
instruction 1
instruction 2
instruction 3
```

Can be replaced with:

```
begin:      jmp    ins1_label
ins2_label: instruction 2
            jmp    ins3_label
ins3_label: instruction 3
            jmp    exit:
ins1_label: instruction 1
            jmp    ins2_label
exit:
```

## Using indirect pointers

```
dummy_data1 db 100h dup (0)
message1    db 'hello world',0

dummy_data2 db 200h dup (0)
message2    db 'another message',0

func        proc
            ...
            mov    eax, offset dummy_data1 ; PE or ELF reloc here
            add    eax, 100h
            push   eax
            call   dump_string
            ...
            mov    eax, offset dummy_data2 ; PE or ELF reloc here
            add    eax, 200h
            push   eax
            call   dump_string
            ...
func        endp
```

IDA will show references only to `dummy_data1` and `dummy_data2`, but not to the text strings.

Global variables and even functions may be accessed like that.

Now something slightly more advanced.

Honestly, I don't know its exact name, but I would call it *shifted pointer*. This technique is quite common, at least in copy protection schemes.

In short: while writing a value into global memory you use an address, but by reading you use a sum of (other) addresses, or maybe a difference. The goal is to hide a real address from a reverse engineer who debugs the code or exploring it in IDA (or another disassembler).

This can be a nuisance.

```

#include <stdio.h>

// 64KiB, but it's OK
unsigned char secret_array[0x10000];

void check_lic_key()
{
    // pretend licence check has been failed
    secret_array[0x6123]=1; // 1 mean failed

    printf ("check failed\n"); // exit(0); // / a cracker may patch here

    // or put there another value if check is succeeded
    secret_array[0x6123]=0;
};

unsigned char get_byte_at_0x6000(unsigned char *a)
{
    return *(a+0x6000);
};

void check_again()
{
    if (get_byte_at_0x6000(secret_array+0x123)==1)
    {
        // do something mean (add watermark maybe) or report error:
        printf ("check failed\n");
    }
    else
    {
        // proceed further
    };
};

int main()
{
    // at start:
    check_lic_key();

    // do something

    // ... and while in some very critical part:
    check_again();
};

```

If compiled by non-optimizing MSVC 2015:

```

_check_lic_key  proc near
                push    ebp
                mov     ebp, esp
                mov     eax, 1
                imul   ecx, eax, 6123h
                mov     _secret_array[ecx], 1
                pop     ebp
                retn
_check_lic_key  endp

_get_byte_at_0x6000  proc near
a
                = dword ptr 8

                push    ebp
                mov     ebp, esp
                mov     eax, [ebp+a]
                mov     al, [eax+6000h]
                pop     ebp
                retn
_get_byte_at_0x6000  endp

```

```

_check_again    proc near
                push    ebp
                mov     ebp, esp
                push    offset point_passed_to_get_byte_at_0x6000
                call   j__get_byte_at_0x6000
                add     esp, 4
                movzx   eax, al
                cmp     eax, 1
                jnz    short loc_406735
                push    offset _Format ; "check failed\n"
                call   j__printf
                add     esp, 4

loc_406735:
                pop     ebp
                retn
_check_again    endp

.data:0045F5C0 ; char secret_array[65536]
.data:0045F5C0 _secret_array db 123h dup(?)
.data:0045F6E3 ; char point_passed_to_get_byte_at_0x6000[65245]
.data:0045F6E3 point_passed_to_get_byte_at_0x6000 db 0FEDDh dup(?)

```

You see, IDA can only get two addresses: `secret_array[]` (start of the array) and `point_passed_to_get_byte_at_0x6000`.

How to deal with it: you can use hardware breakpoints on memory access operations (tracer has BPMx options) or symbolic execution engine or maybe you can write a plugin for IDA...

Surely, one array can be used for many values, not limited to boolean ones...

N.B.: Optimizing MSVC 2015 is smart enough to optimize the `get_byte_at_0x6000()` function out.

### 3.20.3 Virtual machine / pseudo-code

A programmer can construct his/her own PL or ISA and interpreter for it.

(Like the pre-5.0 Visual Basic, .NET or Java machines). The reverse engineer will have to spend some time to understand the meaning and details of all of the ISA's instructions.

He/she will also have to write a disassembler/decompiler of some sort.

### 3.20.4 Other things to mention

My own (yet weak) attempt to patch the Tiny C compiler to produce obfuscated code: <http://go.yurichev.com/17220>.

Using the MOV instruction for really complicated things: [Stephen Dolan, *mov is Turing-complete*, (2013)]<sup>22</sup>.

### 3.20.5 Exercise

- <http://challenges.re/29>

## 3.21 C++

### 3.21.1 Classes

#### A simple example

Internally, the representation of C++ classes is almost the same as the structures.

Let's try an example with two variables, two constructors and one method:

<sup>22</sup>Also available as <http://www.cl.cam.ac.uk/~sd601/papers/mov.pdf>

```

#include <stdio.h>

class c
{
private:
    int v1;
    int v2;
public:
    c() // default ctor
    {
        v1=667;
        v2=999;
    };

    c(int a, int b) // ctor
    {
        v1=a;
        v2=b;
    };

    void dump()
    {
        printf ("%d; %d\n", v1, v2);
    };
};

int main()
{
    class c c1;
    class c c2(5,6);

    c1.dump();
    c2.dump();

    return 0;
};

```

## MSVC: x86

Here is how the main() function looks like, translated into assembly language:

Listing 3.84: MSVC

```

_c2$ = -16 ; size = 8
_c1$ = -8 ; size = 8
_main PROC
    push ebp
    mov  ebp, esp
    sub  esp, 16
    lea  ecx, DWORD PTR _c1$[ebp]
    call ??0c@@QAE@XZ ; c::c
    push 6
    push 5
    lea  ecx, DWORD PTR _c2$[ebp]
    call ??0c@@QAE@HH@Z ; c::c
    lea  ecx, DWORD PTR _c1$[ebp]
    call ?dump@c@@QAE@XZ ; c::dump
    lea  ecx, DWORD PTR _c2$[ebp]
    call ?dump@c@@QAE@XZ ; c::dump
    xor  eax, eax
    mov  esp, ebp
    pop  ebp
    ret  0
_main ENDP

```

Here's what's going on. For each object (instance of class *c*) 8 bytes are allocated, exactly the size needed to store the 2 variables.

For *c1* a default argumentless constructor `??0c@@QAE@XZ` is called. For *c2* another constructor `??0c@@QAE@HH@Z` is called and two numbers are passed as arguments.

A pointer to the object (*this* in C++ terminology) is passed in the ECX register. This is called `thiscall` (3.21.1)—the method for passing a pointer to the object.

MSVC does it using the ECX register. Needless to say, it is not a standardized method, other compilers can do it differently, e.g., via the first function argument (like GCC).

Why do these functions have such odd names? That's [name mangling](#).

A C++ class may contain several methods sharing the same name but having different arguments—that is polymorphism. And of course, different classes may have their own methods with the same name.

*Name mangling* enable us to encode the class name + method name + all method argument types in one ASCII string, which is then used as an internal function name. That's all because neither the linker, nor the DLL `OS` loader (mangled names may be among the DLL exports as well) knows anything about C++ or `OOP`<sup>23</sup>.

The `dump()` function is called two times.

Now let's see the constructors' code:

Listing 3.85: MSVC

```
_this$ = -4 ; size = 4
??0c@@QAE@XZ PROC ; c::c, COMDAT
; _this$ = ecx
    push ebp
    mov  ebp, esp
    push ecx
    mov  DWORD PTR _this$[ebp], ecx
    mov  eax, DWORD PTR _this$[ebp]
    mov  DWORD PTR [eax], 667
    mov  ecx, DWORD PTR _this$[ebp]
    mov  DWORD PTR [ecx+4], 999
    mov  eax, DWORD PTR _this$[ebp]
    mov  esp, ebp
    pop  ebp
    ret  0
??0c@@QAE@XZ ENDP ; c::c

_this$ = -4 ; size = 4
_a$ = 8 ; size = 4
_b$ = 12 ; size = 4
??0c@@QAE@HH@Z PROC ; c::c, COMDAT
; _this$ = ecx
    push ebp
    mov  ebp, esp
    push ecx
    mov  DWORD PTR _this$[ebp], ecx
    mov  eax, DWORD PTR _this$[ebp]
    mov  ecx, DWORD PTR _a$[ebp]
    mov  DWORD PTR [eax], ecx
    mov  edx, DWORD PTR _this$[ebp]
    mov  eax, DWORD PTR _b$[ebp]
    mov  DWORD PTR [edx+4], eax
    mov  eax, DWORD PTR _this$[ebp]
    mov  esp, ebp
    pop  ebp
    ret  8
??0c@@QAE@HH@Z ENDP ; c::c
```

The constructors are just functions, they use a pointer to the structure in ECX, copying the pointer into their own local variable, however, it is not necessary.

From the C++ standard (C++11 12.1) we know that constructors are not required to return any values.

In fact, internally, the constructors return a pointer to the newly created object, i.e., *this*.

Now the `dump()` method:

<sup>23</sup>Object-Oriented Programming

Listing 3.86: MSVC

```

_this$ = -4 ; size = 4
?dump@@@QAEXXZ PROC ; c::dump, COMDAT
; _this$ = ecx
    push ebp
    mov  ebp, esp
    push ecx
    mov  DWORD PTR _this$[ebp], ecx
    mov  eax, DWORD PTR _this$[ebp]
    mov  ecx, DWORD PTR [eax+4]
    push ecx
    mov  edx, DWORD PTR _this$[ebp]
    mov  eax, DWORD PTR [edx]
    push eax
    push OFFSET ??_C@_07NJBDCIEC@?$CFd?$DL?5?$CFd?6?$AA@
    call _printf
    add  esp, 12
    mov  esp, ebp
    pop  ebp
    ret  0
?dump@@@QAEXXZ ENDP ; c::dump

```

Simple enough: `dump()` takes a pointer to the structure that contains the two *int*'s from `ECX`, takes both values from it and passes them to `printf()`.

The code is much shorter if compiled with optimizations (`/Ox`):

Listing 3.87: MSVC

```

??0c@@QAE@XZ PROC ; c::c, COMDAT
; _this$ = ecx
    mov  eax, ecx
    mov  DWORD PTR [eax], 667
    mov  DWORD PTR [eax+4], 999
    ret  0
??0c@@QAE@XZ ENDP ; c::c

_a$ = 8 ; size = 4
_b$ = 12 ; size = 4
??0c@@QAE@HH@Z PROC ; c::c, COMDAT
; _this$ = ecx
    mov  edx, DWORD PTR _b$[esp-4]
    mov  eax, ecx
    mov  ecx, DWORD PTR _a$[esp-4]
    mov  DWORD PTR [eax], ecx
    mov  DWORD PTR [eax+4], edx
    ret  8
??0c@@QAE@HH@Z ENDP ; c::c

?dump@@@QAEXXZ PROC ; c::dump, COMDAT
; _this$ = ecx
    mov  eax, DWORD PTR [ecx+4]
    mov  ecx, DWORD PTR [ecx]
    push eax
    push ecx
    push OFFSET ??_C@_07NJBDCIEC@?$CFd?$DL?5?$CFd?6?$AA@
    call _printf
    add  esp, 12
    ret  0
?dump@@@QAEXXZ ENDP ; c::dump

```

That's all. The other thing we must note is that the [stack pointer](#) hasn't been corrected with `add esp, X` after the constructor has been called. At the same time, the constructor has `ret 8` instead of `RET` at the end.

This is all because the `thiscall` ([3.21.1 on the preceding page](#)) calling convention is used here, which together with the `stdcall` ([6.1.2 on page 735](#)) method offers the [callee](#) to correct the stack instead of the [caller](#). The `ret x` instruction adds `X` to the value in `ESP`, then passes the control to the [caller](#) function.

See also the section about calling conventions ([6.1 on page 735](#)).

It also has to be noted that the compiler decides when to call the constructor and destructor—but we already know that from the C++ language basics.

## MSVC: x86-64

As we already know, the first 4 function arguments in x86-64 are passed in RCX, RDX, R8 and R9 registers, all the rest—via the stack.

Nevertheless, the *this* pointer to the object is passed in RCX, the first argument of the method in RDX, etc. We can see this in the `c(int a, int b)` method internals:

Listing 3.88: Optimizing MSVC 2012 x64

```
; void dump()
?dump@@@QEAAAXZ PROC ; c::dump
    mov     r8d, DWORD PTR [rcx+4]
    mov     edx, DWORD PTR [rcx]
    lea    rcx, OFFSET FLAT:??_C@_07NJBDCIEC@?$CFd?$DL?5?$CFd?6?$AA@ ; '%d; %d'
    jmp    printf
?dump@@@QEAAAXZ ENDP ; c::dump

; c(int a, int b)
??0c@@QEAA@HH@Z PROC ; c::c
    mov     DWORD PTR [rcx], edx ; 1st argument: a
    mov     DWORD PTR [rcx+4], r8d ; 2nd argument: b
    mov     rax, rcx
    ret     0
??0c@@QEAA@HH@Z ENDP ; c::c

; default ctor
??0c@@QEAA@XZ PROC ; c::c
    mov     DWORD PTR [rcx], 667
    mov     DWORD PTR [rcx+4], 999
    mov     rax, rcx
    ret     0
??0c@@QEAA@XZ ENDP ; c::c
```

The *int* data type is still 32-bit in x64<sup>24</sup>, so that is why 32-bit register parts are used here.

We also see `JMP printf` instead of `RET` in the `dump()` method, that *hack* we already saw earlier: [1.21.1 on page 156](#).

## GCC: x86

It is almost the same story in GCC 4.4.1, with a few exceptions.

Listing 3.89: GCC 4.4.1

```
public main
main proc near

var_20 = dword ptr -20h
var_1C = dword ptr -1Ch
var_18 = dword ptr -18h
var_10 = dword ptr -10h
var_8 = dword ptr -8

    push ebp
    mov  ebp, esp
    and  esp, 0FFFFFFF0h
    sub  esp, 20h
    lea  eax, [esp+20h+var_8]
    mov  [esp+20h+var_20], eax
    call _ZN1cC1Ev
```

<sup>24</sup>Apparently, for easier porting of 32-bit C/C++ code to x64.

```

mov [esp+20h+var_18], 6
mov [esp+20h+var_1C], 5
lea eax, [esp+20h+var_10]
mov [esp+20h+var_20], eax
call _ZN1cC1Eii
lea eax, [esp+20h+var_8]
mov [esp+20h+var_20], eax
call _ZN1c4dumpEv
lea eax, [esp+20h+var_10]
mov [esp+20h+var_20], eax
call _ZN1c4dumpEv
mov eax, 0
leave
retn
main endp

```

Here we see another *name mangling* style, specific to GNU <sup>25</sup>. It can also be noted that the pointer to the object is passed as the first function argument—invisible to programmer, of course.

First constructor:

```

_ZN1cC1Ev      public _ZN1cC1Ev ; weak
               proc near                ; CODE XREF: main+10
arg_0          = dword ptr 8
               push    ebp
               mov     ebp, esp
               mov     eax, [ebp+arg_0]
               mov     dword ptr [eax], 667
               mov     eax, [ebp+arg_0]
               mov     dword ptr [eax+4], 999
               pop     ebp
               retn
_ZN1cC1Ev      endp

```

It just writes two numbers using the pointer passed in the first (and only) argument.

Second constructor:

```

_ZN1cC1Eii    public _ZN1cC1Eii
               proc near
arg_0          = dword ptr 8
arg_4          = dword ptr 0Ch
arg_8          = dword ptr 10h
               push    ebp
               mov     ebp, esp
               mov     eax, [ebp+arg_0]
               mov     edx, [ebp+arg_4]
               mov     [eax], edx
               mov     eax, [ebp+arg_0]
               mov     edx, [ebp+arg_8]
               mov     [eax+4], edx
               pop     ebp
               retn
_ZN1cC1Eii    endp

```

This is a function, the analog of which can look like this:

```

void ZN1cC1Eii (int *obj, int a, int b)
{

```

<sup>25</sup>There is a good document about the various name mangling conventions in different compilers: [Agner Fog, *Calling conventions* (2015)].



```

*obj=a;
*(obj+1)=b;
};

```

...and that is completely predictable.

Now the `dump()` function:

```

_ZN1c4dumpEv    public _ZN1c4dumpEv
_ZN1c4dumpEv    proc near
var_18          = dword ptr -18h
var_14          = dword ptr -14h
var_10          = dword ptr -10h
arg_0           = dword ptr 8

                push    ebp
                mov     ebp, esp
                sub     esp, 18h
                mov     eax, [ebp+arg_0]
                mov     edx, [eax+4]
                mov     eax, [ebp+arg_0]
                mov     eax, [eax]
                mov     [esp+18h+var_10], edx
                mov     [esp+18h+var_14], eax
                mov     [esp+18h+var_18], offset aDD ; "%d; %d\n"
                call    _printf
                leave
                retn
_ZN1c4dumpEv    endp

```

This function in its *internal representation* has only one argument, used as pointer to the object (*this*).

This function could be rewritten in C like this:

```

void ZN1c4dumpEv (int *obj)
{
    printf ("%d; %d\n", *obj, *(obj+1));
};

```

Thus, if we base our judgment on these simple examples, the difference between MSVC and GCC is the style of the encoding of function names (*name mangling*) and the method for passing a pointer to the object (via the ECX register or via the first argument).

### **GCC: x86-64**

The first 6 arguments, as we already know, are passed in the RDI, RSI, RDX, RCX, R8 and R9 ([Michael Matz, Jan Hubicka, Andreas Jaeger, Mark Mitchell, *System V Application Binary Interface. AMD64 Architecture Processor Supplement*, (2013)]<sup>26</sup>) registers, and the pointer to *this* via the first one (RDI) and that is what we see here. The *int* data type is also 32-bit here.

The JMP instead of RET *hack* is also used here.

Listing 3.90: GCC 4.4.6 x64

```

; default ctor

_ZN1c2Ev:
    mov  DWORD PTR [rdi], 667
    mov  DWORD PTR [rdi+4], 999
    ret

; c(int a, int b)

_ZN1c2Eii:
    mov  DWORD PTR [rdi], esi

```

<sup>26</sup>Also available as <https://software.intel.com/sites/default/files/article/402129/mpx-linux64-abi.pdf>

```

    mov  DWORD PTR [rdi+4], edx
    ret

; dump()

_ZN1c4dumpEv:
    mov  edx, DWORD PTR [rdi+4]
    mov  esi, DWORD PTR [rdi]
    xor  eax, eax
    mov  edi, OFFSET FLAT:.LC0 ; "%d; %d\n"
    jmp  printf

```

## Class inheritance

Inherited classes are similar to the simple structures we already discussed, but extended in inheritable classes.

Let's take this simple example:

```

#include <stdio.h>

class object
{
    public:
        int color;
        object() { };
        object(int color) { this->color=color; };
        void print_color() { printf ("color=%d\n", color); };
};

class box : public object
{
    private:
        int width, height, depth;
    public:
        box(int color, int width, int height, int depth)
        {
            this->color=color;
            this->width=width;
            this->height=height;
            this->depth=depth;
        };
        void dump()
        {
            printf ("this is a box. color=%d, width=%d, height=%d, depth=%d\n", color, width, ↵
            ↵ height, depth);
        };
};

class sphere : public object
{
    private:
        int radius;
    public:
        sphere(int color, int radius)
        {
            this->color=color;
            this->radius=radius;
        };
        void dump()
        {
            printf ("this is sphere. color=%d, radius=%d\n", color, radius);
        };
};

int main()
{
    box b(1, 10, 20, 30);
    sphere s(2, 40);
}

```

```

    b.print_color();
    s.print_color();

    b.dump();
    s.dump();

    return 0;
};

```

Let's investigate the generated code of the `dump()` functions/methods and also `object::print_color()`, and see the memory layout for the structures-objects (for 32-bit code).

So, here are the `dump()` methods for several classes, generated by MSVC 2008 with `/Ox` and `/Ob0` options <sup>27</sup>.

Listing 3.91: Optimizing MSVC 2008 /Ob0

```

??_C@_09GCED0LPA@color?$DN?$CFd?6?$AA@ DB 'color=%d', 0aH, 00H ; `string'
?print_color@object@@QAEXXZ PROC ; object::print_color, COMDAT
; _this$ = ecx
    mov     eax, DWORD PTR [ecx]
    push   eax

; 'color=%d', 0aH, 00H
    push   OFFSET ??_C@_09GCED0LPA@color?$DN?$CFd?6?$AA@
    call   _printf
    add    esp, 8
    ret    0
?print_color@object@@QAEXXZ ENDP ; object::print_color

```

Listing 3.92: Optimizing MSVC 2008 /Ob0

```

?dump@box@@QAEXXZ PROC ; box::dump, COMDAT
; _this$ = ecx
    mov     eax, DWORD PTR [ecx+12]
    mov     edx, DWORD PTR [ecx+8]
    push   eax
    mov     eax, DWORD PTR [ecx+4]
    mov     ecx, DWORD PTR [ecx]
    push   edx
    push   eax
    push   ecx

; 'this is a box. color=%d, width=%d, height=%d, depth=%d', 0aH, 00H ; `string'
    push   OFFSET ??_C@_0DG@NCNGAADL@this?5is?5box?4?5color?$DN?$CFd?0?5width?$DN?$CFd?0@
    call   _printf
    add    esp, 20
    ret    0
?dump@box@@QAEXXZ ENDP ; box::dump

```

Listing 3.93: Optimizing MSVC 2008 /Ob0

```

?dump@sphere@@QAEXXZ PROC ; sphere::dump, COMDAT
; _this$ = ecx
    mov     eax, DWORD PTR [ecx+4]
    mov     ecx, DWORD PTR [ecx]
    push   eax
    push   ecx

; 'this is sphere. color=%d, radius=%d', 0aH, 00H
    push   OFFSET ??_C@_0CF@EFEDJLDC@this?5is?5sphere?4?5color?$DN?$CFd?0?5radius@
    call   _printf
    add    esp, 12
    ret    0
?dump@sphere@@QAEXXZ ENDP ; sphere::dump

```

So, here is the memory layout:

(base class *object*)

<sup>27</sup>The `/Ob0` option stands for disabling inline expansion since function inlining can make our experiment harder.

offset	description
+0x0	int color

(inherited classes)

*box*:

offset	description
+0x0	int color
+0x4	int width
+0x8	int height
+0xC	int depth

*sphere*:

offset	description
+0x0	int color
+0x4	int radius

Let's see `main()` function body:

Listing 3.94: Optimizing MSVC 2008 /Ob0

```

PUBLIC _main
_TEXT SEGMENT
_s$ = -24 ; size = 8
_b$ = -16 ; size = 16
_main PROC
    sub esp, 24
    push 30
    push 20
    push 10
    push 1
    lea ecx, DWORD PTR _b$[esp+40]
    call ??0box@@QAE@HHHH@Z ; box::box
    push 40
    push 2
    lea ecx, DWORD PTR _s$[esp+32]
    call ??0sphere@@QAE@HH@Z ; sphere::sphere
    lea ecx, DWORD PTR _b$[esp+24]
    call ?print_color@object@@QAEXXZ ; object::print_color
    lea ecx, DWORD PTR _s$[esp+24]
    call ?print_color@object@@QAEXXZ ; object::print_color
    lea ecx, DWORD PTR _b$[esp+24]
    call ?dump@box@@QAEXXZ ; box::dump
    lea ecx, DWORD PTR _s$[esp+24]
    call ?dump@sphere@@QAEXXZ ; sphere::dump
    xor eax, eax
    add esp, 24
    ret 0
_main ENDP

```

The inherited classes must always add their fields after the base classes' fields, to make it possible for the base class methods to work with their own fields.

When the `object::print_color()` method is called, a pointers to both the *box* and *sphere* objects are passed as `this`, and it can work with these objects easily since the *color* field in these objects is always at the pinned address (at offset `+0x0`).

It can be said that the `object::print_color()` method is agnostic in relation to the input object type as long as the fields are *pinned* at the same addresses, and this condition is always true.

And if you create inherited class of the *box* class, the compiler will add the new fields after the *depth* field, leaving the *box* class fields at the pinned addresses.

Thus, the `box::dump()` method will work fine for accessing the *color*, *width*, *height* and *depths* fields, which are always pinned at known addresses.

The code generated by GCC is almost the same, with the sole exception of passing the `this` pointer (as it has been explained above, it is passed as the first argument instead of using the ECX register).

## Encapsulation

Encapsulation is hiding the data in the *private* sections of the class, e.g. to allow access to them only from this class methods.

However, are there any marks in code the about the fact that some field is private and some other—not? No, there are no such marks.

Let's try this simple example:

```
#include <stdio.h>

class box
{
    private:
        int color, width, height, depth;
    public:
        box(int color, int width, int height, int depth)
        {
            this->color=color;
            this->width=width;
            this->height=height;
            this->depth=depth;
        };
        void dump()
        {
            printf ("this is a box. color=%d, width=%d, height=%d, depth=%d\n", color, width, ↵
↵ height, depth);
        };
};
```

Let's compile it again in MSVC 2008 with /Ox and /Ob0 options and see the box::dump() method code:

```
?dump@box@@QAEXXZ PROC ; box::dump, COMDAT
; _this$ = ecx
    mov     eax, DWORD PTR [ecx+12]
    mov     edx, DWORD PTR [ecx+8]
    push   eax
    mov     eax, DWORD PTR [ecx+4]
    mov     ecx, DWORD PTR [ecx]
    push   edx
    push   eax
    push   ecx
; 'this is a box. color=%d, width=%d, height=%d, depth=%d', 0aH, 00H
    push   OFFSET ??_C@_0DG@NCGAADL@this?5is?5box?4?5color?$DN?$CFd?0?5width?$DN?$CFd?0@
    call   _printf
    add     esp, 20
    ret     0
?dump@box@@QAEXXZ ENDP ; box::dump
```

Here is a memory layout of the class:

offset	description
+0x0	int color
+0x4	int width
+0x8	int height
+0xC	int depth

All fields are private and not allowed to be accessed from any other function, but knowing this layout, can we create code that modifies these fields?

To do this we'll add the `hack_oop_encapsulation()` function, which is not going to compile if it looked like this:

```
void hack_oop_encapsulation(class box * o)
{
    o->width=1; // that code can't be compiled:
               // "error C2248: 'box::width' : cannot access private member declared in class
    'box'"
};
```

Nevertheless, if we cast the *box* type to a *pointer to an int array*, and we modify the array of *int*-s that we have, we can succeed.

```
void hack_oop_encapsulation(class box * o)
{
    unsigned int *ptr_to_object=reinterpret_cast<unsigned int*>(o);
    ptr_to_object[1]=123;
};
```

This function's code is very simple—it can be said that the function takes a pointer to an array of *int*-s for input and writes *123* to the second *int*:

```
?hack_oop_encapsulation@@YAXPAVbox@@@Z PROC ; hack_oop_encapsulation
    mov eax, DWORD PTR _o$[esp-4]
    mov DWORD PTR [eax+4], 123
    ret 0
?hack_oop_encapsulation@@YAXPAVbox@@@Z ENDP ; hack_oop_encapsulation
```

Let's check how it works:

```
int main()
{
    box b(1, 10, 20, 30);

    b.dump();

    hack_oop_encapsulation(&b);

    b.dump();

    return 0;
};
```

Let's run:

```
this is a box. color=1, width=10, height=20, depth=30
this is a box. color=1, width=123, height=20, depth=30
```

We see that the encapsulation is just protection of class fields only in the compilation stage.

The C++ compiler is not allowing the generation of code that modifies protected fields straightforwardly, nevertheless, it is possible with the help of *dirty hacks*.

## Multiple inheritance

Multiple inheritance is creating a class which inherits fields and methods from two or more classes.

Let's write a simple example again:

```
#include <stdio.h>

class box
{
public:
    int width, height, depth;
    box() { };
    box(int width, int height, int depth)
    {
        this->width=width;
        this->height=height;
        this->depth=depth;
    };
    void dump()
    {
        printf ("this is a box. width=%d, height=%d, depth=%d\n", width, height, depth);
    };
    int get_volume()
    {
```

```

        return width * height * depth;
    };
};

class solid_object
{
public:
    int density;
    solid_object() { };
    solid_object(int density)
    {
        this->density=density;
    };
    int get_density()
    {
        return density;
    };
    void dump()
    {
        printf ("this is a solid_object. density=%d\n", density);
    };
};

class solid_box: box, solid_object
{
public:
    solid_box (int width, int height, int depth, int density)
    {
        this->width=width;
        this->height=height;
        this->depth=depth;
        this->density=density;
    };
    void dump()
    {
        printf ("this is a solid_box. width=%d, height=%d, depth=%d, density=%d\n", width, ↵
↵ height, depth, density);
    };
    int get_weight() { return get_volume() * get_density(); };
};

int main()
{
    box b(10, 20, 30);
    solid_object so(100);
    solid_box sb(10, 20, 30, 3);

    b.dump();
    so.dump();
    sb.dump();
    printf ("%d\n", sb.get_weight());

    return 0;
};

```

Let's compile it in MSVC 2008 with the /Ox and /Ob0 options and see the code of box::dump(), solid\_object::dump() and solid\_box::dump():

Listing 3.95: Optimizing MSVC 2008 /Ob0

```

?dump@box@@QAEXXZ PROC ; box::dump, COMDAT
; _this$ = ecx
    mov     eax, DWORD PTR [ecx+8]
    mov     edx, DWORD PTR [ecx+4]
    push   eax
    mov     eax, DWORD PTR [ecx]
    push   edx
    push   eax
; 'this is a box. width=%d, height=%d, depth=%d', 0aH, 00H
    push   OFFSET ??_C@_0CM@DIKPHDFI@this?5is?5box?4?5width?5DN?5CFd@0?5height?5DN?5CFd@

```

```

call _printf
add esp, 16
ret 0
?dump@box@@@QAEXXZ ENDP ; box::dump

```

Listing 3.96: Optimizing MSVC 2008 /Ob0

```

?dump@solid_object@@@QAEXXZ PROC ; solid_object::dump, COMDAT
; _this$ = ecx
mov eax, DWORD PTR [ecx]
push eax
; 'this is a solid_object. density=%d', 0aH
push OFFSET ??_C@_0CC@KICFJINL@this?5is?5solid_object?4?5density?$DN?$CFd@
call _printf
add esp, 8
ret 0
?dump@solid_object@@@QAEXXZ ENDP ; solid_object::dump

```

Listing 3.97: Optimizing MSVC 2008 /Ob0

```

?dump@solid_box@@@QAEXXZ PROC ; solid_box::dump, COMDAT
; _this$ = ecx
mov eax, DWORD PTR [ecx+12]
mov edx, DWORD PTR [ecx+8]
push eax
mov eax, DWORD PTR [ecx+4]
mov ecx, DWORD PTR [ecx]
push edx
push eax
push ecx
; 'this is a solid_box. width=%d, height=%d, depth=%d, density=%d', 0aH
push OFFSET ??_C@_0D0@HNCNIHNN@this?5is?5solid_box?4?5width?$DN?$CFd?0?5hei@
call _printf
add esp, 20
ret 0
?dump@solid_box@@@QAEXXZ ENDP ; solid_box::dump

```

So, the memory layout for all three classes is:

*box* class:

offset	description
+0x0	width
+0x4	height
+0x8	depth

*solid\_object* class:

offset	description
+0x0	density

It can be said that the *solid\_box* class memory layout is *united*:

*solid\_box* class:

offset	description
+0x0	width
+0x4	height
+0x8	depth
+0xC	density

The code of the *box::get\_volume()* and *solid\_object::get\_density()* methods is trivial:

Listing 3.98: Optimizing MSVC 2008 /Ob0

```

?get_volume@box@@@QAEXXZ PROC ; box::get_volume, COMDAT
; _this$ = ecx
mov eax, DWORD PTR [ecx+8]
imul eax, DWORD PTR [ecx+4]
imul eax, DWORD PTR [ecx]
ret 0
?get_volume@box@@@QAEXXZ ENDP ; box::get_volume

```



Listing 3.99: Optimizing MSVC 2008 /Ob0

```
?get_density@solid_object@@QAEHXZ PROC ; solid_object::get_density, COMDAT
; _this$ = ecx
    mov eax, DWORD PTR [ecx]
    ret 0
?get_density@solid_object@@QAEHXZ ENDP ; solid_object::get_density
```

But the code of the `solid_box::get_weight()` method is much more interesting:

Listing 3.100: Optimizing MSVC 2008 /Ob0

```
?get_weight@solid_box@@QAEHXZ PROC ; solid_box::get_weight, COMDAT
; _this$ = ecx
    push esi
    mov esi, ecx
    push edi
    lea ecx, DWORD PTR [esi+12]
    call ?get_density@solid_object@@QAEHXZ ; solid_object::get_density
    mov ecx, esi
    mov edi, eax
    call ?get_volume@box@@QAEHXZ ; box::get_volume
    imul eax, edi
    pop edi
    pop esi
    ret 0
?get_weight@solid_box@@QAEHXZ ENDP ; solid_box::get_weight
```

`get_weight()` just calls two methods, but for `get_volume()` it just passes pointer to this, and for `get_density()` it passes a pointer to this incremented by 12 (or `0xC`) bytes, and there, in the `solid_box` class memory layout, the fields of the `solid_object` class start.

Thus, the `solid_object::get_density()` method will believe like it is dealing with the usual `solid_object` class, and the `box::get_volume()` method will work with its three fields, believing this is just the usual object of class `box`.

Thus, we can say, an object of a class, that inherits from several other classes, is representing in memory as a *united* class, that contains all inherited fields. And each inherited method is called with a pointer to the corresponding structure's part.

## Virtual methods

Yet another simple example:

```
#include <stdio.h>

class object
{
public:
    int color;
    object() { };
    object (int color) { this->color=color; };
    virtual void dump()
    {
        printf ("color=%d\n", color);
    };
};

class box : public object
{
private:
    int width, height, depth;
public:
    box(int color, int width, int height, int depth)
    {
        this->color=color;
        this->width=width;
        this->height=height;
        this->depth=depth;
    };
    void dump()
```

```

    {
        printf ("this is a box. color=%d, width=%d, height=%d, depth=%d\n", color, width, ↵
        height, depth);
    };
};

class sphere : public object
{
private:
    int radius;
public:
    sphere(int color, int radius)
    {
        this->color=color;
        this->radius=radius;
    };
    void dump()
    {
        printf ("this is sphere. color=%d, radius=%d\n", color, radius);
    };
};

int main()
{
    box b(1, 10, 20, 30);
    sphere s(2, 40);

    object *o1=&b;
    object *o2=&s;

    o1->dump();
    o2->dump();
    return 0;
};

```

Class *object* has a virtual method `dump()` that is being replaced in the inheriting *box* and *sphere* classes. If we are in an environment where it is not known the type of an object, as in the `main()` function in example, where the virtual method `dump()` is called, the information about its type must be stored somewhere, to be able to call the relevant virtual method.

Let's compile it in MSVC 2008 with the `/Ox` and `/Ob0` options and see the code of `main()`:

```

_s$ = -32 ; size = 12
_b$ = -20 ; size = 20
_main PROC
    sub esp, 32
    push 30
    push 20
    push 10
    push 1
    lea ecx, DWORD PTR _b$[esp+48]
    call ??0box@@QAE@HHHH@Z ; box::box
    push 40
    push 2
    lea ecx, DWORD PTR _s$[esp+40]
    call ??0sphere@@QAE@HH@Z ; sphere::sphere
    mov eax, DWORD PTR _b$[esp+32]
    mov edx, DWORD PTR [eax]
    lea ecx, DWORD PTR _b$[esp+32]
    call edx
    mov eax, DWORD PTR _s$[esp+32]
    mov edx, DWORD PTR [eax]
    lea ecx, DWORD PTR _s$[esp+32]
    call edx
    xor eax, eax
    add esp, 32
    ret 0
_main ENDP

```

A pointer to the `dump()` function is taken somewhere from the object. Where could we store the address of the new method? Only somewhere in the constructors: there is no other place since nothing else is called in the `main()` function. <sup>28</sup>

Let's see the code of the constructor of the `box` class:

```

??_R0?AVbox@@@8 DD FLAT:??_7type_info@@6B@ ; box `RTTI Type Descriptor'
  DD  00H
  DB  '?.AVbox@', 00H

??_R1A@?0A@EA@box@@8 DD FLAT:??_R0?AVbox@@@8 ; box::`RTTI Base Class Descriptor at (0,-1,0,64)'
  DD  01H
  DD  00H
  DD  0fffffffH
  DD  00H
  DD  040H
  DD  FLAT:??_R3box@@@8

??_R2box@@8 DD FLAT:??_R1A@?0A@EA@box@@@8 ; box::`RTTI Base Class Array'
  DD  FLAT:??_R1A@?0A@EA@object@@@8

??_R3box@@8 DD 00H ; box::`RTTI Class Hierarchy Descriptor'
  DD  00H
  DD  02H
  DD  FLAT:??_R2box@@@8

??_R4box@@6B@ DD 00H ; box::`RTTI Complete Object Locator'
  DD  00H
  DD  00H
  DD  FLAT:??_R0?AVbox@@@8
  DD  FLAT:??_R3box@@@8

??_7box@@6B@ DD FLAT:??_R4box@@6B@ ; box::`vftable'
  DD  FLAT:?dump@box@@@UAEXXZ

_color$ = 8 ; size = 4
_width$ = 12 ; size = 4
_height$ = 16 ; size = 4
_depth$ = 20 ; size = 4
??0box@@QAE@HHHH@Z PROC ; box::box, COMDAT
; _this$ = ecx
  push esi
  mov esi, ecx
  call ??0object@@QAE@XZ ; object::object
  mov eax, DWORD PTR _color$[esp]
  mov ecx, DWORD PTR _width$[esp]
  mov edx, DWORD PTR _height$[esp]
  mov DWORD PTR [esi+4], eax
  mov eax, DWORD PTR _depth$[esp]
  mov DWORD PTR [esi+16], eax
  mov DWORD PTR [esi], OFFSET ??_7box@@6B@
  mov DWORD PTR [esi+8], ecx
  mov DWORD PTR [esi+12], edx
  mov eax, esi
  pop esi
  ret 16
??0box@@QAE@HHHH@Z ENDP ; box::box

```

Here we see a slightly different memory layout: the first field is a pointer to some table `box::`vftable'` (the name has been set by the MSVC compiler).

In this table we see a link to a table named `box::`RTTI Complete Object Locator'` and also a link to the `box::dump()` method.

These are called virtual methods table and [RTTI](#)<sup>29</sup>. The table of virtual methods has the addresses of methods and the [RTTI](#) table contains information about types.

<sup>28</sup>You can read more about pointers to functions in the relevant section: ([1.33 on page 384](#))

<sup>29</sup>Run-Time Type Information

By the way, the [RTTI](#) tables are used while calling `dynamic_cast` and `typeid` in C++. You can also see here the class name as a plain text string.

Thus, a method of the base *object* class may call the virtual method `object::dump()`, which in turn will call a method of an inherited class, since that information is present right in the object's structure.

Some additional CPU time is needed for doing look-ups in these tables and finding the right virtual method address, thus virtual methods are widely considered as slightly slower than common methods.

In GCC-generated code the [RTTI](#) tables are constructed slightly differently.

### 3.21.2 ostream

Let's start again with a "hello world" example, but now we are going to use *ostream*:

```
#include <iostream>

int main()
{
    std::cout << "Hello, world!\n";
}
```

Almost any C++ textbook tells us that the `<<` operation can be defined (*overloaded*) for other types. That is what is done in *ostream*. We see that `operator<<` is called for *ostream*:

Listing 3.101: MSVC 2012 (reduced listing)

```
$SG37112 DB 'Hello, world!', 0aH, 00H

_main PROC
    push OFFSET $SG37112
    push OFFSET ?cout@std@@3V?$basic_ostream@DU?$char_traits@D@std@@@1@A ; std::cout
    call ???$?6U?$char_traits@D@std@@@std@@YAAAV?$basic_ostream@DU?↵
    ↵ $char_traits@D@std@@@0@AAV10@PBD@Z ; std::operator<<<std::char_traits<char>
    >
    add esp, 8
    xor eax, eax
    ret 0
_main ENDP
```

Let's modify the example:

```
#include <iostream>

int main()
{
    std::cout << "Hello, " << "world!\n";
}
```

And again, from many C++ textbooks we know that the result of each `operator<<` in *ostream* is forwarded to the next one. Indeed:

Listing 3.102: MSVC 2012

```
$SG37112 DB 'world!', 0aH, 00H
$SG37113 DB 'Hello, ', 00H

_main PROC
    push OFFSET $SG37113 ; 'Hello, '
    push OFFSET ?cout@std@@3V?$basic_ostream@DU?$char_traits@D@std@@@1@A ; std::cout
    call ???$?6U?$char_traits@D@std@@@std@@YAAAV?$basic_ostream@DU?↵
    ↵ $char_traits@D@std@@@0@AAV10@PBD@Z ; std::operator<<<std::char_traits<char>
    >
    add esp, 8

    push OFFSET $SG37112 ; 'world!'
    push eax ; result of previous function execution
    call ???$?6U?$char_traits@D@std@@@std@@YAAAV?$basic_ostream@DU?↵
    ↵ $char_traits@D@std@@@0@AAV10@PBD@Z ; std::operator<<<std::char_traits<char>
    >
    add esp, 8

    xor eax, eax
```

```
    ret 0
_main ENDP
```

If we would rename operator<< method name to f(), that code will look like:

```
f(f(std::cout, "Hello, "), "world!");
```

GCC generates almost the same code as MSVC.

### 3.21.3 References

In C++, references are pointers ( [3.23 on page 600](#)) as well, but they are called *safe*, because it is harder to make a mistake while dealing with them (C++11 8.3.2).

For example, reference must always be pointing to an object of the corresponding type and cannot be NULL [Marshall Cline, C++ FAQ8.6].

Even more than that, references cannot be changed, it is impossible to point them to another object (reset) [Marshall Cline, C++ FAQ8.5].

If we are going to change the example with pointers ( [3.23 on page 600](#)) to use references instead ...

```
void f2 (int x, int y, int & sum, int & product)
{
    sum=x+y;
    product=x*y;
};
```

...then we can see that the compiled code is just the same as in the pointers example ( [3.23 on page 600](#)):

Listing 3.103: Optimizing MSVC 2010

```
_x$ = 8      ; size = 4
_y$ = 12     ; size = 4
_sum$ = 16   ; size = 4
_product$ = 20 ; size = 4
?f2@@YAXHAAH0@Z PROC    ; f2
    mov     ecx, DWORD PTR _y$[esp-4]
    mov     eax, DWORD PTR _x$[esp-4]
    lea    edx, DWORD PTR [eax+ecx]
    imul   eax, ecx
    mov    ecx, DWORD PTR _product$[esp-4]
    push   esi
    mov    esi, DWORD PTR _sum$[esp]
    mov    DWORD PTR [esi], edx
    mov    DWORD PTR [ecx], eax
    pop    esi
    ret    0
?f2@@YAXHAAH0@Z ENDP    ; f2
```

(The reason why C++ functions has such strange names is explained here: [3.21.1 on page 547](#).)

Hence, C++ references are as much efficient as usual pointers.

### 3.21.4 STL

N.B.: all examples here were checked only in 32-bit environment. x64 wasn't checked.

#### std::string

##### Internals

Many string libraries [Dennis Yurichev, *C/C++ programming language notes2.2*] implement a structure that contains a pointer to a string buffer, a variable that always contains the current string length (which

is very convenient for many functions: [Dennis Yurichev, *C/C++ programming language notes*2.2.1]) and a variable containing the current buffer size.

The string in the buffer is usually terminated with zero, in order to be able to pass a pointer to the buffer into the functions that take usual C [ASCIIZ](#) strings.

It is not specified in the C++ standard how `std::string` has to be implemented, however, it is usually implemented as explained above.

The C++ string is not a class (as `QString` in Qt, for instance) but a template (`basic_string`), this is made in order to support various character types: at least `char` and `wchar_t`.

So, `std::string` is a class with `char` as its base type.

And `std::wstring` is a class with `wchar_t` as its base type.

## MSVC

The MSVC implementation may store the buffer in place instead of using a pointer to a buffer (if the string is shorter than 16 symbols).

This implies that a short string is to occupy at least  $16 + 4 + 4 = 24$  bytes in 32-bit environment or at least  $16 + 8 + 8 = 32$

bytes in 64-bit one, and if the string is longer than 16 characters, we also have to add the length of the string itself.

Listing 3.104: example for MSVC

```
#include <string>
#include <stdio.h>

struct std_string
{
    union
    {
        char buf[16];
        char* ptr;
    } u;
    size_t size; // AKA 'Mysize' in MSVC
    size_t capacity; // AKA 'Myres' in MSVC
};

void dump_std_string(std::string s)
{
    struct std_string *p=(struct std_string*)&s;
    printf ("[%s] size:%d capacity:%d\n", p->size>16 ? p->u.ptr : p->u.buf, p->size, p->↵
↵ capacity);
};

int main()
{
    std::string s1="a short string";
    std::string s2="a string longer than 16 bytes";

    dump_std_string(s1);
    dump_std_string(s2);

    // that works without using c_str()
    printf ("%s\n", &s1);
    printf ("%s\n", s2);
};
```

Almost everything is clear from the source code.

A couple of notes:

If the string is shorter than 16 symbols, a buffer for the string is not to be allocated in the [heap](#).

This is convenient because in practice, a lot of strings are short indeed.

Looks like that Microsoft's developers chose 16 characters as a good balance.

One very important thing here can be seen at the end of `main()`: we're not using the `c_str()` method, nevertheless, if we compile and run this code, both strings will appear in the console!

This is why it works.

In the first case the string is shorter than 16 characters and the buffer with the string is located in the beginning of the `std::string` object (it can be treated as a structure). `printf()` treats the pointer as a pointer to the null-terminated array of characters, hence it works.

Printing the second string (longer than 16 characters) is even more dangerous: it is a typical programmer's mistake (or typo) to forget to write `c_str()`.

This works because at the moment a pointer to buffer is located at the start of structure.

This may stay unnoticed for a long time, until a longer string appears there at some time, then the process will crash.

## GCC

GCC's implementation of this structure has one more variable—reference count.

One interesting fact is that in GCC, a pointer to an instance of `std::string` instance points not to the beginning of the structure, but to the buffer pointer. In `libstdc++-v3/include/bits/basic_string.h` we can read that it was done for more convenient debugging:

```
* The reason you want _M_data pointing to the character %array and
* not the _Rep is so that the debugger can see the string
* contents. (Probably we should add a non-inline member to get
* the _Rep for the debugger to use, so users can check the actual
* string length.)
```

### [basic\\_string.h source code](#)

We consider this in our example:

Listing 3.105: example for GCC

```
#include <string>
#include <stdio.h>

struct std_string
{
    size_t length;
    size_t capacity;
    size_t refcount;
};

void dump_std_string(std::string s)
{
    char *p1=(char*)&s; // GCC type checking workaround
    struct std_string *p2=(struct std_string*)(p1-sizeof(struct std_string));
    printf ("[%s] size:%d capacity:%d\n", p1, p2->length, p2->capacity);
};

int main()
{
    std::string s1="a short string";
    std::string s2="a string longer than 16 bytes";

    dump_std_string(s1);
    dump_std_string(s2);

    // GCC type checking workaround:
    printf ("%s\n", *(char*)&s1);
    printf ("%s\n", *(char*)&s2);
};
```

A trickery has to be used to imitate the mistake we already have seen above because GCC has stronger type checking, nevertheless, `printf()` works here without `c_str()` as well.

## A more advanced example

```
#include <string>
#include <stdio.h>

int main()
{
    std::string s1="Hello, ";
    std::string s2="world!\n";
    std::string s3=s1+s2;

    printf ("%s\n", s3.c_str());
}
```

Listing 3.106: MSVC 2012

```
$SG39512 DB 'Hello, ', 00H
$SG39514 DB 'world!', 0aH, 00H
$SG39581 DB '%s', 0aH, 00H

_s2$ = -72 ; size = 24
_s3$ = -48 ; size = 24
_s1$ = -24 ; size = 24
_main PROC
    sub     esp, 72

    push   7
    push   OFFSET $SG39512
    lea    ecx, DWORD PTR _s1$[esp+80]
    mov    DWORD PTR _s1$[esp+100], 15
    mov    DWORD PTR _s1$[esp+96], 0
    mov    BYTE PTR _s1$[esp+80], 0
    call  ?assign@?$basic_string@DU?$char_traits@D@std@@V?$allocator@D@2@@std@@QAEAAV12@PBIDI@Z ;
    std::basic_string<char,std::char_traits<char>,std::allocator<char> >::assign

    push   7
    push   OFFSET $SG39514
    lea    ecx, DWORD PTR _s2$[esp+80]
    mov    DWORD PTR _s2$[esp+100], 15
    mov    DWORD PTR _s2$[esp+96], 0
    mov    BYTE PTR _s2$[esp+80], 0
    call  ?assign@?$basic_string@DU?$char_traits@D@std@@V?$allocator@D@2@@std@@QAEAAV12@PBIDI@Z ;
    std::basic_string<char,std::char_traits<char>,std::allocator<char> >::assign

    lea    eax, DWORD PTR _s2$[esp+72]
    push   eax
    lea    eax, DWORD PTR _s1$[esp+76]
    push   eax
    lea    eax, DWORD PTR _s3$[esp+80]
    push   eax
    call  ???$HDU?$char_traits@D@std@@V?$allocator@D@1@@std@@YA?AV?$basic_string@DU?
    ↵ $char_traits@D@std@@V?$allocator@D@2@@@ABV10@@@Z ;
    std::operator+<char,std::char_traits<char>,std::allocator<char> >

    ; inlined c_str() method:
    cmp    DWORD PTR _s3$[esp+104], 16
    lea    eax, DWORD PTR _s3$[esp+84]
    cmovae eax, DWORD PTR _s3$[esp+84]

    push   eax
    push   OFFSET $SG39581
    call  _printf
    add    esp, 20

    cmp    DWORD PTR _s3$[esp+92], 16
    jb     SHORT $LN119@main
    push   DWORD PTR _s3$[esp+72]
    call  ???@YAXPAX@Z ; operator delete
    add    esp, 4
$LN119@main:
```



```

    cmp  DWORD PTR _s2$[esp+92], 16
    mov  DWORD PTR _s3$[esp+92], 15
    mov  DWORD PTR _s3$[esp+88], 0
    mov  BYTE PTR _s3$[esp+72], 0
    jb   SHORT $LN151@main
    push DWORD PTR _s2$[esp+72]
    call ??3@YAXPAX@Z           ; operator delete
    add  esp, 4
$LN151@main:
    cmp  DWORD PTR _s1$[esp+92], 16
    mov  DWORD PTR _s2$[esp+92], 15
    mov  DWORD PTR _s2$[esp+88], 0
    mov  BYTE PTR _s2$[esp+72], 0
    jb   SHORT $LN195@main
    push DWORD PTR _s1$[esp+72]
    call ??3@YAXPAX@Z           ; operator delete
    add  esp, 4
$LN195@main:
    xor  eax, eax
    add  esp, 72
    ret  0
_main ENDP

```

The compiler does not construct strings statically: it would not be possible anyway if the buffer needs to be located in the [heap](#).

Instead, the [ASCIIZ](#) strings are stored in the data segment, and later, at runtime, with the help of the “assign” method, the s1 and s2 strings are constructed. And with the help of operator+, the s3 string is constructed.

Please note that there is no call to the `c_str()` method, because its code is tiny enough so the compiler inlined it right there: if the string is shorter than 16 characters, a pointer to buffer is left in EAX, otherwise the address of the string buffer located in the [heap](#) is fetched.

Next, we see calls to the 3 destructors, they are called if the string is longer than 16 characters: then the buffers in the [heap](#) have to be freed. Otherwise, since all three `std::string` objects are stored in the stack, they are freed automatically, when the function ends.

As a consequence, processing short strings is faster, because of less [heap](#) accesses.

GCC code is even simpler (because the GCC way, as we saw above, is to not store shorter strings right in the structure):

Listing 3.107: GCC 4.8.1

```

.LC0:
    .string "Hello, "
.LC1:
    .string "world!\n"
main:
    push ebp
    mov  ebp, esp
    push edi
    push esi
    push ebx
    and  esp, -16
    sub  esp, 32
    lea  ebx, [esp+28]
    lea  edi, [esp+20]
    mov  DWORD PTR [esp+8], ebx
    lea  esi, [esp+24]
    mov  DWORD PTR [esp+4], OFFSET FLAT:.LC0
    mov  DWORD PTR [esp], edi

    call _ZNSsC1EPKcRKSaIcE

    mov  DWORD PTR [esp+8], ebx
    mov  DWORD PTR [esp+4], OFFSET FLAT:.LC1
    mov  DWORD PTR [esp], esi

    call _ZNSsC1EPKcRKSaIcE

```

```

mov  DWORD PTR [esp+4], edi
mov  DWORD PTR [esp], ebx

call _ZNSsC1ERKSs

mov  DWORD PTR [esp+4], esi
mov  DWORD PTR [esp], ebx

call _ZNSs6appendERKSs

; inlined c_str():
mov  eax, DWORD PTR [esp+28]
mov  DWORD PTR [esp], eax

call puts

mov  eax, DWORD PTR [esp+28]
lea  ebx, [esp+19]
mov  DWORD PTR [esp+4], ebx
sub  eax, 12
mov  DWORD PTR [esp], eax
call _ZNSs4_Rep10_M_disposeERKSaIcE
mov  eax, DWORD PTR [esp+24]
mov  DWORD PTR [esp+4], ebx
sub  eax, 12
mov  DWORD PTR [esp], eax
call _ZNSs4_Rep10_M_disposeERKSaIcE
mov  eax, DWORD PTR [esp+20]
mov  DWORD PTR [esp+4], ebx
sub  eax, 12
mov  DWORD PTR [esp], eax
call _ZNSs4_Rep10_M_disposeERKSaIcE
lea  esp, [ebp-12]
xor  eax, eax
pop  ebx
pop  esi
pop  edi
pop  ebp
ret

```

It can be seen that it's not a pointer to the object that is passed to destructors, but rather an address 12 bytes (or 3 words) before, i.e., a pointer to the real start of the structure.

### std::string as a global variable

Experienced C++ programmers know that global variables of [STL<sup>30</sup>](#) types can be defined without problems.

Yes, indeed:

```

#include <stdio.h>
#include <string>

std::string s="a string";

int main()
{
    printf ("%s\n", s.c_str());
};

```

But how and where `std::string` constructor will be called?

In fact, this variable is to be initialized even before `main()` start.

Listing 3.108: MSVC 2012: here is how a global variable is constructed and also its destructor is registered

```

??_Es@@YAXXZ PROC

```

<sup>30</sup>(C++) Standard Template Library

```

push 8
push OFFSET $SG39512 ; 'a string'
mov ecx, OFFSET ?s@@3V?$basic_string@DU?$char_traits@D@std@@V?$allocator@D@2@@std@@A ; s
call ?assign@?$basic_string@DU?$char_traits@D@std@@V?$allocator@D@2@@std@@QAEAAV12@PBDI@Z ;
std::basic_string<char,std::char_traits<char>,std::allocator<char> >::assign
push OFFSET ??_Fs@@YAXXZ ; `dynamic atexit destructor for 's'
call _atexit
pop ecx
ret 0
??_Fs@@YAXXZ ENDP

```

Listing 3.109: MSVC 2012: here a global variable is used in main()

```

$SG39512 DB 'a string', 00H
$SG39519 DB '%s', 0aH, 00H

_main PROC
cmp DWORD PTR ?s@@3V?$basic_string@DU?$char_traits@D@std@@V?$allocator@D@2@@std@@A+20, 16
mov eax, OFFSET ?s@@3V?$basic_string@DU?$char_traits@D@std@@V?$allocator@D@2@@std@@A ; s
cmovae eax, DWORD PTR ?s@@3V?$basic_string@DU?$char_traits@D@std@@V?$allocator@D@2@@std@@A
push eax
push OFFSET $SG39519 ; '%s'
call _printf
add esp, 8
xor eax, eax
ret 0
_main ENDP

```

Listing 3.110: MSVC 2012: this destructor function is called before exit

```

??_Fs@@YAXXZ PROC
push ecx
cmp DWORD PTR ?s@@3V?$basic_string@DU?$char_traits@D@std@@V?$allocator@D@2@@std@@A+20, 16
jb SHORT $LN23@dynamic
push esi
mov esi, DWORD PTR ?s@@3V?$basic_string@DU?$char_traits@D@std@@V?$allocator@D@2@@std@@A
lea ecx, DWORD PTR $T2[esp+8]
call ??0?$_Wrap_alloc@V?$allocator@D@std@@@std@@QAE@XZ
push OFFSET ?s@@3V?$basic_string@DU?$char_traits@D@std@@V?$allocator@D@2@@std@@A ; s
lea ecx, DWORD PTR $T2[esp+12]
call ??$destroy@PAD@?$_Wrap_alloc@V?$allocator@D@std@@@std@@QAE@XZ
lea ecx, DWORD PTR $T1[esp+8]
call ??0?$_Wrap_alloc@V?$allocator@D@std@@@std@@QAE@XZ
push esi
call ??3@YAXPAX@Z ; operator delete
add esp, 4
pop esi
$LN23@dynamic:
mov DWORD PTR ?s@@3V?$basic_string@DU?$char_traits@D@std@@V?$allocator@D@2@@std@@A+20, 15
mov DWORD PTR ?s@@3V?$basic_string@DU?$char_traits@D@std@@V?$allocator@D@2@@std@@A+16, 0
mov BYTE PTR ?s@@3V?$basic_string@DU?$char_traits@D@std@@V?$allocator@D@2@@std@@A, 0
pop ecx
ret 0
??_Fs@@YAXXZ ENDP

```

In fact, a special function with all constructors of global variables is called from [CRT](#), before main().

More than that: with the help of atexit() another function is registered, which contain calls to all destructors of such global variables.

GCC works likewise:

Listing 3.111: GCC 4.8.1

```

main:
push ebp
mov ebp, esp
and esp, -16
sub esp, 16
mov eax, DWORD PTR s
mov DWORD PTR [esp], eax

```

```

    call puts
    xor  eax, eax
    leave
    ret
.LC0:
    .string "a string"
_GLOBAL__sub_I_s:
    sub  esp, 44
    lea  eax, [esp+31]
    mov  DWORD PTR [esp+8], eax
    mov  DWORD PTR [esp+4], OFFSET FLAT:.LC0
    mov  DWORD PTR [esp], OFFSET FLAT:s
    call _ZN5sC1EPKcRKSaIcE
    mov  DWORD PTR [esp+8], OFFSET FLAT:__dso_handle
    mov  DWORD PTR [esp+4], OFFSET FLAT:s
    mov  DWORD PTR [esp], OFFSET FLAT:_ZN5sD1Ev
    call __cxa_atexit
    add  esp, 44
    ret
.LFE645:
    .size _GLOBAL__sub_I_s, .-_GLOBAL__sub_I_s
    .section .init_array,"aw"
    .align 4
    .long _GLOBAL__sub_I_s
    .globl s
    .bss
    .align 4
    .type s, @object
    .size s, 4
s:
    .zero 4
    .hidden __dso_handle

```

But it does not create a separate function for this, each destructor is passed to atexit(), one by one.

### std::list

This is the well-known doubly-linked list: each element has two pointers, to the previous and next elements.

This implies that the memory footprint is enlarged by 2 **words** for each element (8 bytes in 32-bit environment or 16 bytes in 64-bit).

C++ STL just adds the “next” and “previous” pointers to the existing structure of the type that you want to unite in a list.

Let’s work out an example with a simple 2-variable structure that we want to store in a list.

Although the C++ standard does not say how to implement it, both MSVC’s and GCC’s implementations are straightforward and similar, so here is only one source code for both:

```

#include <stdio.h>
#include <list>
#include <iostream>

struct a
{
    int x;
    int y;
};

struct List_node
{
    struct List_node* _Next;
    struct List_node* _Prev;
    int x;
    int y;
};

void dump_List_node (struct List_node *n)

```

```

{
    printf ("ptr=0x%p _Next=0x%p _Prev=0x%p x=%d y=%d\n",
           n, n->_Next, n->_Prev, n->x, n->y);
};

void dump_List_vals (struct List_node* n)
{
    struct List_node* current=n;

    for (;;)
    {
        dump_List_node (current);
        current=current->_Next;
        if (current==n) // end
            break;
    };
};

void dump_List_val (unsigned int *a)
{
#ifdef _MSC_VER
    // GCC implementation does not have "size" field
    printf ("_Myhead=0x%p, _Mysize=%d\n", a[0], a[1]);
#endif
    dump_List_vals ((struct List_node*)a[0]);
};

int main()
{
    std::list<struct a> l;

    printf ("* empty list:\n");
    dump_List_val((unsigned int*)(void*)&l);

    struct a t1;
    t1.x=1;
    t1.y=2;
    l.push_front (t1);
    t1.x=3;
    t1.y=4;
    l.push_front (t1);
    t1.x=5;
    t1.y=6;
    l.push_back (t1);

    printf ("* 3-elements list:\n");
    dump_List_val((unsigned int*)(void*)&l);

    std::list<struct a>::iterator tmp;
    printf ("node at .begin:\n");
    tmp=l.begin();
    dump_List_node ((struct List_node *)*(void**)&tmp);
    printf ("node at .end:\n");
    tmp=l.end();
    dump_List_node ((struct List_node *)*(void**)&tmp);

    printf ("* let's count from the beginning:\n");
    std::list<struct a>::iterator it=l.begin();
    printf ("1st element: %d %d\n", (*it).x, (*it).y);
    it++;
    printf ("2nd element: %d %d\n", (*it).x, (*it).y);
    it++;
    printf ("3rd element: %d %d\n", (*it).x, (*it).y);
    it++;
    printf ("element at .end(): %d %d\n", (*it).x, (*it).y);

    printf ("* let's count from the end:\n");
    std::list<struct a>::iterator it2=l.end();
    printf ("element at .end(): %d %d\n", (*it2).x, (*it2).y);
    it2--;
}

```

```

printf ("3rd element: %d %d\n", (*it2).x, (*it2).y);
it2--;
printf ("2nd element: %d %d\n", (*it2).x, (*it2).y);
it2--;
printf ("1st element: %d %d\n", (*it2).x, (*it2).y);

printf ("removing last element...\n");
l.pop_back();
dump_List_val((unsigned int*)(void*)&l);
};

```

## GCC

Let's start with GCC.

When we run the example, we'll see a long dump, let's work with it in pieces.

```

* empty list:
ptr=0x0028fe90 _Next=0x0028fe90 _Prev=0x0028fe90 x=3 y=0

```

Here we see an empty list.

Despite the fact it is empty, it has one element with garbage (AKA *dummy node*) in  $x$  and  $y$ . Both the "next" and "prev" pointers are pointing to the self node:

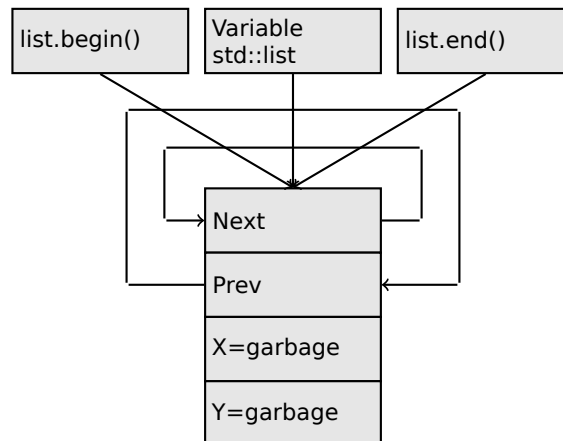

At this moment, the .begin and .end iterators are equal to each other.

If we push 3 elements, the list internally will be:

```

* 3-elements list:
ptr=0x000349a0 _Next=0x00034988 _Prev=0x0028fe90 x=3 y=4
ptr=0x00034988 _Next=0x00034b40 _Prev=0x000349a0 x=1 y=2
ptr=0x00034b40 _Next=0x0028fe90 _Prev=0x00034988 x=5 y=6
ptr=0x0028fe90 _Next=0x000349a0 _Prev=0x00034b40 x=5 y=6

```

The last element is still at 0x0028fe90, it not to be moved until the list's disposal.

It still contain random garbage in  $x$  and  $y$  (5 and 6). By coincidence, these values are the same as in the last element, but it doesn't mean that they are meaningful.

Here is how these 3 elements are stored in memory:

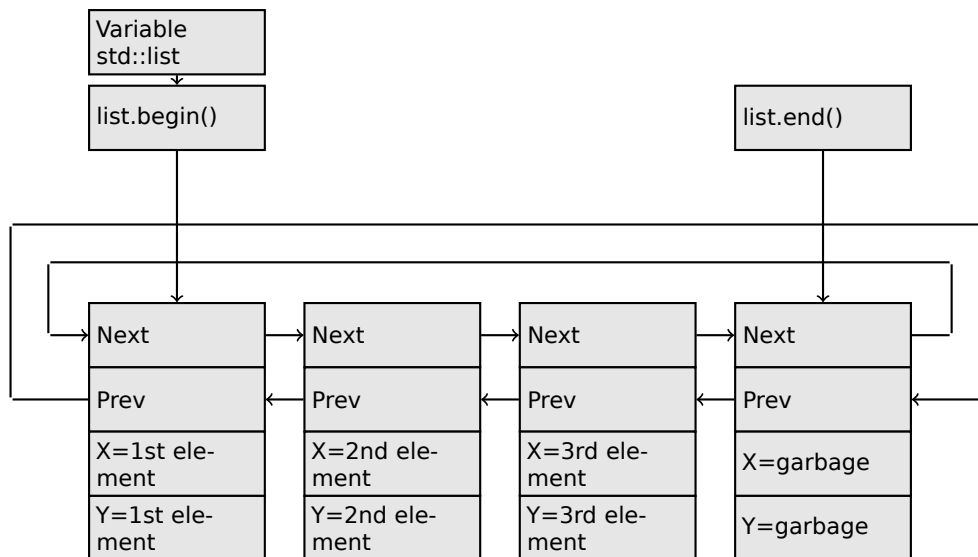

The  $l$  variable always points to the first node.

The `.begin()` and `.end()` iterators are not variables, but functions, which when called return pointers to the corresponding nodes.

Having a dummy element (AKA *sentinel node*) is a very popular practice in implementing doubly-linked lists.

Without it, a lot of operations may become slightly more complex and, hence, slower.

The iterator is in fact just a pointer to a node. `list.begin()` and `list.end()` just return pointers.

```
node at .begin:
ptr=0x000349a0 _Next=0x00034988 _Prev=0x0028fe90 x=3 y=4
node at .end:
ptr=0x0028fe90 _Next=0x000349a0 _Prev=0x00034b40 x=5 y=6
```

The fact that the last element has a pointer to the first and the first element has a pointer to the last one remind us of circular lists.

This is very helpful here: having a pointer to the first list element, i.e., that is in the  $l$  variable, it is easy to get a pointer to the last one quickly, without the necessity to traverse the whole list.

Inserting an element at the end of the list is also quick, thanks to this feature.

`operator--` and `operator++` just set the current iterator's value to the `current_node->prev` or `current_node->next` values.

The reverse iterators (`.rbegin`, `.rend`) work just as the same, but in reverse.

`operator*` just returns a pointer to the point in the node structure, where the user's structure starts, i.e., a pointer to the first element of the structure ( $x$ ).

The list insertion and deletion are trivial: just allocate a new node (or deallocate) and update all pointers to be valid.

That's why an iterator may become invalid after element deletion: it may still point to the node that has been already deallocated. This is also called a *dangling pointer*.

And of course, the information from the freed node (to which iterator still points) cannot be used anymore.

The GCC implementation (as of 4.8.1) doesn't store the current size of the list: this implies a slow `.size()` method: it has to traverse the whole list to count the elements, because it doesn't have any other way to get the information.

This means that this operation is  $O(n)$ , i.e., it steadily gets slower as the list grows.

Listing 3.112: Optimizing GCC 4.8.1 `-fno-inline-small-functions`

```
main proc near
    push ebp
    mov ebp, esp
    push esi
    push ebx
```

```

and esp, 0FFFFFF0h
sub esp, 20h
lea ebx, [esp+10h]
mov dword ptr [esp], offset s ; "* empty list:"
mov [esp+10h], ebx
mov [esp+14h], ebx
call puts
mov [esp], ebx
call _Z13dump_List_valPj ; dump_List_val(uint *)
lea esi, [esp+18h]
mov [esp+4], esi
mov [esp], ebx
mov dword ptr [esp+18h], 1 ; X for new element
mov dword ptr [esp+1Ch], 2 ; Y for new element
call _ZNSt4listIlaSaIS0_EE10push_frontERKS0_ ;
std::list<a,std::allocator<a>>::push_front(a const&)
mov [esp+4], esi
mov [esp], ebx
mov dword ptr [esp+18h], 3 ; X for new element
mov dword ptr [esp+1Ch], 4 ; Y for new element
call _ZNSt4listIlaSaIS0_EE10push_frontERKS0_ ;
std::list<a,std::allocator<a>>::push_front(a const&)
mov dword ptr [esp], 10h
mov dword ptr [esp+18h], 5 ; X for new element
mov dword ptr [esp+1Ch], 6 ; Y for new element
call _Znwj ; operator new(uint)
cmp eax, 0FFFFFFF8h
jz short loc_80002A6
mov ecx, [esp+1Ch]
mov edx, [esp+18h]
mov [eax+0Ch], ecx
mov [eax+8], edx

```

loc\_80002A6: ; CODE XREF: main+86

```

mov [esp+4], ebx
mov [esp], eax
call _ZNSt8_detail15_List_node_base7_M_hookEPS0_ ;
std::_detail::List_node_base::M_hook(std::_detail::List_node_base*)
mov dword ptr [esp], offset a3ElementsList ; "* 3-elements list:"
call puts
mov [esp], ebx
call _Z13dump_List_valPj ; dump_List_val(uint *)
mov dword ptr [esp], offset aNodeAt_begin ; "node at .begin:"
call puts
mov eax, [esp+10h]
mov [esp], eax
call _Z14dump_List_nodeP9List_node ; dump_List_node(List_node *)
mov dword ptr [esp], offset aNodeAt_end ; "node at .end:"
call puts
mov [esp], ebx
call _Z14dump_List_nodeP9List_node ; dump_List_node(List_node *)
mov dword ptr [esp], offset aLetSCountFromT ; "* let's count from the beginning:"
call puts
mov esi, [esp+10h]
mov eax, [esi+0Ch]
mov [esp+0Ch], eax
mov eax, [esi+8]
mov dword ptr [esp+4], offset a1stElementDD ; "1st element: %d %d\n"
mov dword ptr [esp], 1
mov [esp+8], eax
call __printf_chk
mov esi, [esi] ; operator++: get ->next pointer
mov eax, [esi+0Ch]
mov [esp+0Ch], eax
mov eax, [esi+8]
mov dword ptr [esp+4], offset a2ndElementDD ; "2nd element: %d %d\n"
mov dword ptr [esp], 1
mov [esp+8], eax
call __printf_chk
mov esi, [esi] ; operator++: get ->next pointer

```



```

mov  eax, [esi+0Ch]
mov  [esp+0Ch], eax
mov  eax, [esi+8]
mov  dword ptr [esp+4], offset a3rdElementDD ; "3rd element: %d %d\n"
mov  dword ptr [esp], 1
mov  [esp+8], eax
call __printf_chk
mov  eax, [esi] ; operator++: get ->next pointer
mov  edx, [eax+0Ch]
mov  [esp+0Ch], edx
mov  eax, [eax+8]
mov  dword ptr [esp+4], offset aElementAt_endD ; "element at .end(): %d %d\n"
mov  dword ptr [esp], 1
mov  [esp+8], eax
call __printf_chk
mov  dword ptr [esp], offset aLetSCountFro_0 ; "* let's count from the end:"
call puts
mov  eax, [esp+1Ch]
mov  dword ptr [esp+4], offset aElementAt_endD ; "element at .end(): %d %d\n"
mov  dword ptr [esp], 1
mov  [esp+0Ch], eax
mov  eax, [esp+18h]
mov  [esp+8], eax
call __printf_chk
mov  esi, [esp+14h]
mov  eax, [esi+0Ch]
mov  [esp+0Ch], eax
mov  eax, [esi+8]
mov  dword ptr [esp+4], offset a3rdElementDD ; "3rd element: %d %d\n"
mov  dword ptr [esp], 1
mov  [esp+8], eax
call __printf_chk
mov  esi, [esi+4] ; operator--: get ->prev pointer
mov  eax, [esi+0Ch]
mov  [esp+0Ch], eax
mov  eax, [esi+8]
mov  dword ptr [esp+4], offset a2ndElementDD ; "2nd element: %d %d\n"
mov  dword ptr [esp], 1
mov  [esp+8], eax
call __printf_chk
mov  eax, [esi+4] ; operator--: get ->prev pointer
mov  edx, [eax+0Ch]
mov  [esp+0Ch], edx
mov  eax, [eax+8]
mov  dword ptr [esp+4], offset a1stElementDD ; "1st element: %d %d\n"
mov  dword ptr [esp], 1
mov  [esp+8], eax
call __printf_chk
mov  dword ptr [esp], offset aRemovingLastEl ; "removing last element..."
call puts
mov  esi, [esp+14h]
mov  [esp], esi
call _ZNSt8_detail15_List_node_base9_M_unhookEv ;
std::_detail::List_node_base::_M_unhook(void)
mov  [esp], esi ; void *
call _ZdlPv ; operator delete(void *)
mov  [esp], ebx
call _Zl3dump_List_valPj ; dump_List_val(uint *)
mov  [esp], ebx
call _ZNSt10_List_baseI1aSaIS0_EE8_M_clearEv ;
std::_List_base<a,std::allocator<a>>::_M_clear(void)
lea  esp, [ebp-8]
xor  eax, eax
pop  ebx
pop  esi
pop  ebp
retn

```

main endp

Listing 3.113: The whole output

```

* empty list:
ptr=0x0028fe90 _Next=0x0028fe90 _Prev=0x0028fe90 x=3 y=0
* 3-elements list:
ptr=0x000349a0 _Next=0x00034988 _Prev=0x0028fe90 x=3 y=4
ptr=0x00034988 _Next=0x00034b40 _Prev=0x000349a0 x=1 y=2
ptr=0x00034b40 _Next=0x0028fe90 _Prev=0x00034988 x=5 y=6
ptr=0x0028fe90 _Next=0x000349a0 _Prev=0x00034b40 x=5 y=6
node at .begin:
ptr=0x000349a0 _Next=0x00034988 _Prev=0x0028fe90 x=3 y=4
node at .end:
ptr=0x0028fe90 _Next=0x000349a0 _Prev=0x00034b40 x=5 y=6
* let's count from the beginning:
1st element: 3 4
2nd element: 1 2
3rd element: 5 6
element at .end(): 5 6
* let's count from the end:
element at .end(): 5 6
3rd element: 5 6
2nd element: 1 2
1st element: 3 4
removing last element...
ptr=0x000349a0 _Next=0x00034988 _Prev=0x0028fe90 x=3 y=4
ptr=0x00034988 _Next=0x0028fe90 _Prev=0x000349a0 x=1 y=2
ptr=0x0028fe90 _Next=0x000349a0 _Prev=0x00034988 x=5 y=6

```

## MSVC

MSVC's implementation (2012) is just the same, but it also stores the current size of the list. This implies that the `.size()` method is very fast ( $O(1)$ ): it just reads one value from memory. On the other hand, the size variable must be updated at each insertion/deletion. MSVC's implementation is also slightly different in the way it arranges the nodes:

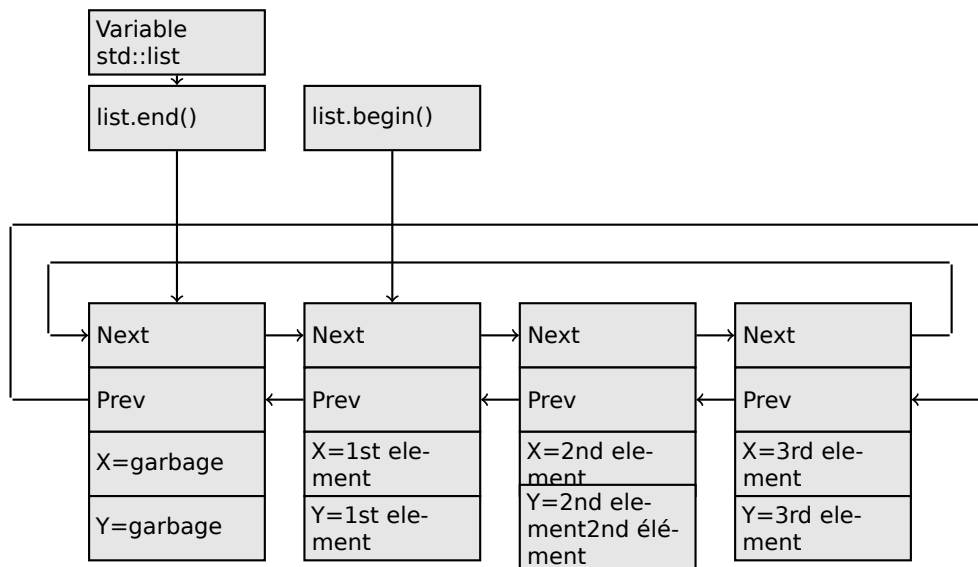

GCC has its dummy element at the end of the list, while MSVC's is at the beginning.

Listing 3.114: Optimizing MSVC 2012 /Fa2.asm /GS- /Ob1

```

_l$ = -16 ; size = 8
_t1$ = -8 ; size = 8
_main PROC
    sub esp, 16
    push ebx
    push esi
    push edi
    push 0
    push 0

```

```

lea ecx, DWORD PTR _l$[esp+36]
mov DWORD PTR _l$[esp+40], 0
; allocate first garbage element
call ?_Buynode0@?$_List_alloc@$0A@U?$_List_base_types@Ua@@V?
↳ $allocator@Ua@@@std@@@std@@@std@@QAEPAU?$_List_node@Ua@@PAX@2@PAU32@0@Z ;
std::_List_alloc<0,std::_List_base_types<a,std::_allocator<a>>>::_Buynode0
mov edi, DWORD PTR __imp__printf
mov ebx, eax
push OFFSET $SG40685 ; '* empty list:'
mov DWORD PTR _l$[esp+32], ebx
call edi ; printf
lea eax, DWORD PTR _l$[esp+32]
push eax
call ?dump_List_val@@YAXPAI@Z ; dump_List_val
mov esi, DWORD PTR [ebx]
add esp, 8
lea eax, DWORD PTR _t1$[esp+28]
push eax
push DWORD PTR [esi+4]
lea ecx, DWORD PTR _l$[esp+36]
push esi
mov DWORD PTR _t1$[esp+40], 1 ; data for a new node
mov DWORD PTR _t1$[esp+44], 2 ; data for a new node
; allocate new node
call ??$_Buynode@ABUa@@@?$_List_buy@Ua@@V?$allocator@Ua@@@std@@@std@@QAEPAU?
↳ $_List_node@Ua@@PAX@1@PAU21@0ABUa@@@Z ;
std::_List_buy<a,std::_allocator<a>>::_Buynode<a const &
mov DWORD PTR [esi+4], eax
mov ecx, DWORD PTR [eax+4]
mov DWORD PTR _t1$[esp+28], 3 ; data for a new node
mov DWORD PTR [ecx], eax
mov esi, DWORD PTR [ebx]
lea eax, DWORD PTR _t1$[esp+28]
push eax
push DWORD PTR [esi+4]
lea ecx, DWORD PTR _l$[esp+36]
push esi
mov DWORD PTR _t1$[esp+44], 4 ; data for a new node
; allocate new node
call ??$_Buynode@ABUa@@@?$_List_buy@Ua@@V?$allocator@Ua@@@std@@@std@@QAEPAU?
↳ $_List_node@Ua@@PAX@1@PAU21@0ABUa@@@Z ;
std::_List_buy<a,std::_allocator<a>>::_Buynode<a const &
mov DWORD PTR [esi+4], eax
mov ecx, DWORD PTR [eax+4]
mov DWORD PTR _t1$[esp+28], 5 ; data for a new node
mov DWORD PTR [ecx], eax
lea eax, DWORD PTR _t1$[esp+28]
push eax
push DWORD PTR [ebx+4]
lea ecx, DWORD PTR _l$[esp+36]
push ebx
mov DWORD PTR _t1$[esp+44], 6 ; data for a new node
; allocate new node
call ??$_Buynode@ABUa@@@?$_List_buy@Ua@@V?$allocator@Ua@@@std@@@std@@QAEPAU?
↳ $_List_node@Ua@@PAX@1@PAU21@0ABUa@@@Z ;
std::_List_buy<a,std::_allocator<a>>::_Buynode<a const &
mov DWORD PTR [ebx+4], eax
mov ecx, DWORD PTR [eax+4]
push OFFSET $SG40689 ; '* 3-elements list:'
mov DWORD PTR _l$[esp+36], 3
mov DWORD PTR [ecx], eax
call edi ; printf
lea eax, DWORD PTR _l$[esp+32]
push eax
call ?dump_List_val@@YAXPAI@Z ; dump_List_val
push OFFSET $SG40831 ; 'node at .begin:'
call edi ; printf
push DWORD PTR [ebx] ; get next field of node "l" variable points to
call ?dump_List_node@@YAXPAUList_node@@@Z ; dump_List_node
push OFFSET $SG40835 ; 'node at .end:'
call edi ; printf

```

```

push ebx ; pointer to the node "l" variable points to!
call ?dump_List_node@@YAXPAUList_node@@@Z ; dump_List_node
push OFFSET $SG40839 ; '* let''s count from the begin:'
call edi ; printf
mov esi, DWORD PTR [ebx] ; operator++: get ->next pointer
push DWORD PTR [esi+12]
push DWORD PTR [esi+8]
push OFFSET $SG40846 ; '1st element: %d %d'
call edi ; printf
mov esi, DWORD PTR [esi] ; operator++: get ->next pointer
push DWORD PTR [esi+12]
push DWORD PTR [esi+8]
push OFFSET $SG40848 ; '2nd element: %d %d'
call edi ; printf
mov esi, DWORD PTR [esi] ; operator++: get ->next pointer
push DWORD PTR [esi+12]
push DWORD PTR [esi+8]
push OFFSET $SG40850 ; '3rd element: %d %d'
call edi ; printf
mov eax, DWORD PTR [esi] ; operator++: get ->next pointer
add esp, 64
push DWORD PTR [eax+12]
push DWORD PTR [eax+8]
push OFFSET $SG40852 ; 'element at .end(): %d %d'
call edi ; printf
push OFFSET $SG40853 ; '* let''s count from the end:'
call edi ; printf
push DWORD PTR [ebx+12] ; use x and y fields from the node "l" variable points to
push DWORD PTR [ebx+8]
push OFFSET $SG40860 ; 'element at .end(): %d %d'
call edi ; printf
mov esi, DWORD PTR [ebx+4] ; operator--: get ->prev pointer
push DWORD PTR [esi+12]
push DWORD PTR [esi+8]
push OFFSET $SG40862 ; '3rd element: %d %d'
call edi ; printf
mov esi, DWORD PTR [esi+4] ; operator--: get ->prev pointer
push DWORD PTR [esi+12]
push DWORD PTR [esi+8]
push OFFSET $SG40864 ; '2nd element: %d %d'
call edi ; printf
mov eax, DWORD PTR [esi+4] ; operator--: get ->prev pointer
push DWORD PTR [eax+12]
push DWORD PTR [eax+8]
push OFFSET $SG40866 ; '1st element: %d %d'
call edi ; printf
add esp, 64
push OFFSET $SG40867 ; 'removing last element...'
call edi ; printf
mov edx, DWORD PTR [ebx+4]
add esp, 4

; prev=next?
; it is the only element, garbage one?
; if yes, do not delete it!
cmp edx, ebx
je SHORT $LN349@main
mov ecx, DWORD PTR [edx+4]
mov eax, DWORD PTR [edx]
mov DWORD PTR [ecx], eax
mov ecx, DWORD PTR [edx]
mov eax, DWORD PTR [edx+4]
push edx
mov DWORD PTR [ecx+4], eax
call ??3@YAXPAX@Z ; operator delete
add esp, 4
mov DWORD PTR _l$[esp+32], 2
$LN349@main:
lea eax, DWORD PTR _l$[esp+28]
push eax

```

```

    call ?dump_List_val@@YAXPAI@Z ; dump_List_val
    mov  eax, DWORD PTR [ebx]
    add  esp, 4
    mov  DWORD PTR [ebx], ebx
    mov  DWORD PTR [ebx+4], ebx
    cmp  eax, ebx
    je   SHORT $LN412@main
$LL414@main:
    mov  esi, DWORD PTR [eax]
    push eax
    call ???@YAXPAX@Z ; operator delete
    add  esp, 4
    mov  eax, esi
    cmp  esi, ebx
    jne  SHORT $LL414@main
$LN412@main:
    push ebx
    call ???@YAXPAX@Z ; operator delete
    add  esp, 4
    xor  eax, eax
    pop  edi
    pop  esi
    pop  ebx
    add  esp, 16
    ret  0
_main ENDP

```

Unlike GCC, MSVC's code allocates the dummy element at the start of the function with the help of the "Buynode" function, it is also used to allocate the rest of the nodes ( GCC's code allocates the first element in the local stack).

Listing 3.115: The whole output

```

* empty list:
_Myhead=0x003CC258, _Mysize=0
ptr=0x003CC258 _Next=0x003CC258 _Prev=0x003CC258 x=6226002 y=4522072
* 3-elements list:
_Myhead=0x003CC258, _Mysize=3
ptr=0x003CC258 _Next=0x003CC288 _Prev=0x003CC2A0 x=6226002 y=4522072
ptr=0x003CC288 _Next=0x003CC270 _Prev=0x003CC258 x=3 y=4
ptr=0x003CC270 _Next=0x003CC2A0 _Prev=0x003CC288 x=1 y=2
ptr=0x003CC2A0 _Next=0x003CC258 _Prev=0x003CC270 x=5 y=6
node at .begin:
ptr=0x003CC288 _Next=0x003CC270 _Prev=0x003CC258 x=3 y=4
node at .end:
ptr=0x003CC258 _Next=0x003CC288 _Prev=0x003CC2A0 x=6226002 y=4522072
* let's count from the beginning:
1st element: 3 4
2nd element: 1 2
3rd element: 5 6
element at .end(): 6226002 4522072
* let's count from the end:
element at .end(): 6226002 4522072
3rd element: 5 6
2nd element: 1 2
1st element: 3 4
removing last element...
_Myhead=0x003CC258, _Mysize=2
ptr=0x003CC258 _Next=0x003CC288 _Prev=0x003CC270 x=6226002 y=4522072
ptr=0x003CC288 _Next=0x003CC270 _Prev=0x003CC258 x=3 y=4
ptr=0x003CC270 _Next=0x003CC258 _Prev=0x003CC288 x=1 y=2

```

## C++11 std::forward\_list

The same thing as std::list, but singly-linked one, i.e., having only the "next" field at each node. It has a smaller memory footprint, but also don't offer the ability to traverse list backwards.

## std::vector

We would call `std::vector` a safe wrapper of the [PODT<sup>31</sup>](#) C array. Internally it is somewhat similar to `std::string` ([3.21.4 on page 563](#)): it has a pointer to the allocated buffer, a pointer to the end of the array, and a pointer to the end of the allocated buffer.

The array's elements lie in memory adjacently to each other, just like in a normal array ([1.26 on page 266](#)). In C++11 there is a new method called `.data()`, that returns a pointer to the buffer, like `.c_str()` in `std::string`.

The buffer allocated in the [heap](#) can be larger than the array itself.

Both MSVC's and GCC's implementations are similar, just the names of the structure's fields are slightly different<sup>32</sup>, so here is one source code that works for both compilers. Here is again the C-like code for dumping the structure of `std::vector`:

```
#include <stdio.h>
#include <vector>
#include <algorithm>
#include <functional>

struct vector_of_ints
{
    // MSVC names:
    int *Myfirst;
    int *Mylast;
    int *Myend;

    // GCC structure is the same, but names are: _M_start, _M_finish, _M_end_of_storage
};

void dump(struct vector_of_ints *in)
{
    printf ("_Myfirst=%p, _Mylast=%p, _Myend=%p\n", in->Myfirst, in->Mylast, in->Myend);
    size_t size=(in->Mylast-in->Myfirst);
    size_t capacity=(in->Myend-in->Myfirst);
    printf ("size=%d, capacity=%d\n", size, capacity);
    for (size_t i=0; i<size; i++)
        printf ("element %d: %d\n", i, in->Myfirst[i]);
};

int main()
{
    std::vector<int> c;
    dump ((struct vector_of_ints*)(void*)&c);
    c.push_back(1);
    dump ((struct vector_of_ints*)(void*)&c);
    c.push_back(2);
    dump ((struct vector_of_ints*)(void*)&c);
    c.push_back(3);
    dump ((struct vector_of_ints*)(void*)&c);
    c.push_back(4);
    dump ((struct vector_of_ints*)(void*)&c);
    c.reserve (6);
    dump ((struct vector_of_ints*)(void*)&c);
    c.push_back(5);
    dump ((struct vector_of_ints*)(void*)&c);
    c.push_back(6);
    dump ((struct vector_of_ints*)(void*)&c);
    printf ("%d\n", c.at(5)); // with bounds checking
    printf ("%d\n", c[8]); // operator[], without bounds checking
};
```

Here is the output of this program when compiled in MSVC:

```
_Myfirst=00000000, _Mylast=00000000, _Myend=00000000
size=0, capacity=0
_Myfirst=0051CF48, _Mylast=0051CF4C, _Myend=0051CF4C
```

<sup>31</sup>(C++) Plain Old Data Type

<sup>32</sup>GCC internals: <http://go.yurichev.com/17086>

```

size=1, capacity=1
element 0: 1
_Myfirst=0051CF58, _Mylast=0051CF60, _Myend=0051CF60
size=2, capacity=2
element 0: 1
element 1: 2
_Myfirst=0051C278, _Mylast=0051C284, _Myend=0051C284
size=3, capacity=3
element 0: 1
element 1: 2
element 2: 3
_Myfirst=0051C290, _Mylast=0051C2A0, _Myend=0051C2A0
size=4, capacity=4
element 0: 1
element 1: 2
element 2: 3
element 3: 4
_Myfirst=0051B180, _Mylast=0051B190, _Myend=0051B198
size=4, capacity=6
element 0: 1
element 1: 2
element 2: 3
element 3: 4
_Myfirst=0051B180, _Mylast=0051B194, _Myend=0051B198
size=5, capacity=6
element 0: 1
element 1: 2
element 2: 3
element 3: 4
element 4: 5
_Myfirst=0051B180, _Mylast=0051B198, _Myend=0051B198
size=6, capacity=6
element 0: 1
element 1: 2
element 2: 3
element 3: 4
element 4: 5
element 5: 6
6
6619158

```

As it can be seen, there is no allocated buffer when `main()` starts. After the first `push_back()` call, a buffer is allocated. And then, after each `push_back()` call, both array size and buffer size (*capacity*) are increased. But the buffer address changes as well, because `push_back()` reallocates the buffer in the [heap](#) each time. It is costly operation, that's why it is very important to predict the size of the array in the future and reserve enough space for it with the `.reserve()` method.

The last number is garbage: there are no array elements at this point, so a random number is printed. This illustrates the fact that operator `[]` of `std::vector` does not check of the index is in the array's bounds. The slower `.at()` method, however, does this checking and throws an `std::out_of_range` exception in case of error.

Let's see the code:

Listing 3.116: MSVC 2012 /GS- /Ob1

```

$SG52650 DB '%d', 0aH, 00H
$SG52651 DB '%d', 0aH, 00H

_this$ = -4 ; size = 4
_Pos$ = 8 ; size = 4
?at@$vector@HV?$allocator@H@std@@@std@@QAEAAHI@Z PROC ;
    std::vector<int,std::allocator<int> >::at, COMDAT
; _this$ = ecx
    push ebp
    mov  ebp, esp
    push ecx
    mov  DWORD PTR _this$[ebp], ecx
    mov  eax, DWORD PTR _this$[ebp]
    mov  ecx, DWORD PTR _this$[ebp]
    mov  edx, DWORD PTR [eax+4]

```

```

sub    edx, DWORD PTR [ecx]
sar    edx, 2
cmp    edx, DWORD PTR __Pos$[ebp]
ja     SHORT $LN1@at
push  OFFSET ??_C@_0BM@NMJKDPP0@invalid?5vector?$DMT?$D0?5subscript?$AA@
call   DWORD PTR __imp?_Xout_of_range@std@@YAXPBD@Z
$LN1@at:
mov    eax, DWORD PTR _this$[ebp]
mov    ecx, DWORD PTR [eax]
mov    edx, DWORD PTR __Pos$[ebp]
lea   eax, DWORD PTR [ecx+edx*4]
$LN3@at:
mov    esp, ebp
pop    ebp
ret    4
?at@$vector@HV?$allocator@H@std@@@std@@QAEEAHI@Z ENDP ; std::vector<int,std::allocator<int>
>::at

_c$ = -36 ; size = 12
$T1 = -24 ; size = 4
$T2 = -20 ; size = 4
$T3 = -16 ; size = 4
$T4 = -12 ; size = 4
$T5 = -8  ; size = 4
$T6 = -4  ; size = 4
_main PROC
push  ebp
mov   ebp, esp
sub   esp, 36
mov   DWORD PTR _c$[ebp], 0      ; Myfirst
mov   DWORD PTR _c$[ebp+4], 0    ; Mylast
mov   DWORD PTR _c$[ebp+8], 0    ; Myend
lea   eax, DWORD PTR _c$[ebp]
push  eax
call  ?dump@@YAXPAUvector_of_ints@@@Z ; dump
add   esp, 4
mov   DWORD PTR $T6[ebp], 1
lea   ecx, DWORD PTR $T6[ebp]
push  ecx
lea   ecx, DWORD PTR _c$[ebp]
call  ?push_back@$vector@HV?$allocator@H@std@@@std@@QAEX$$QAH@Z ;
std::vector<int,std::allocator<int> >::push_back
lea   edx, DWORD PTR _c$[ebp]
push  edx
call  ?dump@@YAXPAUvector_of_ints@@@Z ; dump
add   esp, 4
mov   DWORD PTR $T5[ebp], 2
lea   eax, DWORD PTR $T5[ebp]
push  eax
lea   ecx, DWORD PTR _c$[ebp]
call  ?push_back@$vector@HV?$allocator@H@std@@@std@@QAEX$$QAH@Z ;
std::vector<int,std::allocator<int> >::push_back
lea   ecx, DWORD PTR _c$[ebp]
push  ecx
call  ?dump@@YAXPAUvector_of_ints@@@Z ; dump
add   esp, 4
mov   DWORD PTR $T4[ebp], 3
lea   edx, DWORD PTR $T4[ebp]
push  edx
lea   ecx, DWORD PTR _c$[ebp]
call  ?push_back@$vector@HV?$allocator@H@std@@@std@@QAEX$$QAH@Z ;
std::vector<int,std::allocator<int> >::push_back
lea   eax, DWORD PTR _c$[ebp]
push  eax
call  ?dump@@YAXPAUvector_of_ints@@@Z ; dump
add   esp, 4
mov   DWORD PTR $T3[ebp], 4
lea   ecx, DWORD PTR $T3[ebp]
push  ecx
lea   ecx, DWORD PTR _c$[ebp]
call  ?push_back@$vector@HV?$allocator@H@std@@@std@@QAEX$$QAH@Z ;

```



```

std::vector<int,std::allocator<int> >::push_back
lea edx, DWORD PTR _c$[ebp]
push edx
call ?dump@@YAXPAUvector_of_ints@@@Z ; dump
add esp, 4
push 6
lea ecx, DWORD PTR _c$[ebp]
call ?reserve@?$vector@HV?$allocator@H@std@@std@@QAEXI@Z ;
std::vector<int,std::allocator<int> >::reserve
lea eax, DWORD PTR _c$[ebp]
push eax
call ?dump@@YAXPAUvector_of_ints@@@Z ; dump
add esp, 4
mov DWORD PTR $T2[ebp], 5
lea ecx, DWORD PTR $T2[ebp]
push ecx
lea ecx, DWORD PTR _c$[ebp]
call ?push_back@?$vector@HV?$allocator@H@std@@std@@QAEX$$QAHA@Z ;
std::vector<int,std::allocator<int> >::push_back
lea edx, DWORD PTR _c$[ebp]
push edx
call ?dump@@YAXPAUvector_of_ints@@@Z ; dump
add esp, 4
mov DWORD PTR $T1[ebp], 6
lea eax, DWORD PTR $T1[ebp]
push eax
lea ecx, DWORD PTR _c$[ebp]
call ?push_back@?$vector@HV?$allocator@H@std@@std@@QAEX$$QAHA@Z ;
std::vector<int,std::allocator<int> >::push_back
lea ecx, DWORD PTR _c$[ebp]
push ecx
call ?dump@@YAXPAUvector_of_ints@@@Z ; dump
add esp, 4
push 5
lea ecx, DWORD PTR _c$[ebp]
call ?at@?$vector@HV?$allocator@H@std@@std@@QAEEAHI@Z ; std::vector<int,std::allocator<int>
>::at
mov edx, DWORD PTR [eax]
push edx
push OFFSET $SG52650 ; '%d'
call DWORD PTR __imp__printf
add esp, 8
mov eax, 8
shl eax, 2
mov ecx, DWORD PTR _c$[ebp]
mov edx, DWORD PTR [ecx+eax]
push edx
push OFFSET $SG52651 ; '%d'
call DWORD PTR __imp__printf
add esp, 8
lea ecx, DWORD PTR _c$[ebp]
call ?_Tidy@?$vector@HV?$allocator@H@std@@std@@IAEXXZ ;
std::vector<int,std::allocator<int> >::_Tidy
xor eax, eax
mov esp, ebp
pop ebp
ret 0
_main ENDP

```

We see how the `.at()` method checks the bounds and throws an exception in case of error. The number that the last `printf()` call prints is just taken from the memory, without any checks.

One may ask, why not use the variables like “size” and “capacity”, like it was done in `std::string`. Supposedly, this was done for faster bounds checking.

The code GCC generates is in general almost the same, but the `.at()` method is inlined:

Listing 3.117: GCC 4.8.1 `-fno-inline-small-functions -O1`

```

main proc near
    push ebp
    mov  ebp, esp

```

```

push edi
push esi
push ebx
and esp, 0FFFFFF0h
sub esp, 20h
mov dword ptr [esp+14h], 0
mov dword ptr [esp+18h], 0
mov dword ptr [esp+1Ch], 0
lea eax, [esp+14h]
mov [esp], eax
call _Z4dumpP14vector_of_ints ; dump(vector_of_ints *)
mov dword ptr [esp+10h], 1
lea eax, [esp+10h]
mov [esp+4], eax
lea eax, [esp+14h]
mov [esp], eax
call _ZNSt6vectorIiSaIiEE9push_backERKi ;
std::vector<int,std::allocator<int>>::push_back(int const&)
lea eax, [esp+14h]
mov [esp], eax
call _Z4dumpP14vector_of_ints ; dump(vector_of_ints *)
mov dword ptr [esp+10h], 2
lea eax, [esp+10h]
mov [esp+4], eax
lea eax, [esp+14h]
mov [esp], eax
call _ZNSt6vectorIiSaIiEE9push_backERKi ;
std::vector<int,std::allocator<int>>::push_back(int const&)
lea eax, [esp+14h]
mov [esp], eax
call _Z4dumpP14vector_of_ints ; dump(vector_of_ints *)
mov dword ptr [esp+10h], 3
lea eax, [esp+10h]
mov [esp+4], eax
lea eax, [esp+14h]
mov [esp], eax
call _ZNSt6vectorIiSaIiEE9push_backERKi ;
std::vector<int,std::allocator<int>>::push_back(int const&)
lea eax, [esp+14h]
mov [esp], eax
call _Z4dumpP14vector_of_ints ; dump(vector_of_ints *)
mov dword ptr [esp+10h], 4
lea eax, [esp+10h]
mov [esp+4], eax
lea eax, [esp+14h]
mov [esp], eax
call _ZNSt6vectorIiSaIiEE9push_backERKi ;
std::vector<int,std::allocator<int>>::push_back(int const&)
lea eax, [esp+14h]
mov [esp], eax
call _Z4dumpP14vector_of_ints ; dump(vector_of_ints *)
mov ebx, [esp+14h]
mov eax, [esp+1Ch]
sub eax, ebx
cmp eax, 17h
ja short loc_80001CF
mov edi, [esp+18h]
sub edi, ebx
sar edi, 2
mov dword ptr [esp], 18h
call _Znwj ; operator new(uint)
mov esi, eax
test edi, edi
jz short loc_80001AD
lea eax, ds:0[edi*4]
mov [esp+8], eax ; n
mov [esp+4], ebx ; src
mov [esp], esi ; dest
call memmove

```

loc\_80001AD: ; CODE XREF: main+F8

```

    mov  eax, [esp+14h]
    test eax, eax
    jz   short loc_80001BD
    mov  [esp], eax      ; void *
    call _ZdlPv         ; operator delete(void *)

loc_80001BD: ; CODE XREF: main+117
    mov  [esp+14h], esi
    lea  eax, [esi+edi*4]
    mov  [esp+18h], eax
    add  esi, 18h
    mov  [esp+1Ch], esi

loc_80001CF: ; CODE XREF: main+DD
    lea  eax, [esp+14h]
    mov  [esp], eax
    call _Z4dumpP14vector_of_ints ; dump(vector_of_ints *)
    mov  dword ptr [esp+10h], 5
    lea  eax, [esp+10h]
    mov  [esp+4], eax
    lea  eax, [esp+14h]
    mov  [esp], eax
    call _ZNSt6vectorIiSaIiEE9push_backERKi ;
std::vector<int,std::allocator<int>>::push_back(int const&)
    lea  eax, [esp+14h]
    mov  [esp], eax
    call _Z4dumpP14vector_of_ints ; dump(vector_of_ints *)
    mov  dword ptr [esp+10h], 6
    lea  eax, [esp+10h]
    mov  [esp+4], eax
    lea  eax, [esp+14h]
    mov  [esp], eax
    call _ZNSt6vectorIiSaIiEE9push_backERKi ;
std::vector<int,std::allocator<int>>::push_back(int const&)
    lea  eax, [esp+14h]
    mov  [esp], eax
    call _Z4dumpP14vector_of_ints ; dump(vector_of_ints *)
    mov  eax, [esp+14h]
    mov  edx, [esp+18h]
    sub  edx, eax
    cmp  edx, 17h
    ja  short loc_8000246
    mov  dword ptr [esp], offset aVector_m_range ; "vector::_M_range_check"
    call _ZSt20__throw_out_of_rangePKc ; std::_throw_out_of_range(char const*)

loc_8000246: ; CODE XREF: main+19C
    mov  eax, [eax+14h]
    mov  [esp+8], eax
    mov  dword ptr [esp+4], offset aD ; "%d\n"
    mov  dword ptr [esp], 1
    call __printf_chk
    mov  eax, [esp+14h]
    mov  eax, [eax+20h]
    mov  [esp+8], eax
    mov  dword ptr [esp+4], offset aD ; "%d\n"
    mov  dword ptr [esp], 1
    call __printf_chk
    mov  eax, [esp+14h]
    test eax, eax
    jz   short loc_80002AC
    mov  [esp], eax      ; void *
    call _ZdlPv         ; operator delete(void *)
    jmp  short loc_80002AC

    mov  ebx, eax
    mov  edx, [esp+14h]
    test edx, edx
    jz   short loc_80002A4
    mov  [esp], edx      ; void *
    call _ZdlPv         ; operator delete(void *)

```

```

loc_80002A4: ; CODE XREF: main+1FE
             mov [esp], ebx
             call _Unwind_Resume

loc_80002AC: ; CODE XREF: main+1EA
             ; main+1F4
             mov eax, 0
             lea esp, [ebp-0Ch]
             pop ebx
             pop esi
             pop edi
             pop ebp

locret_80002B8: ; DATA XREF: .eh_frame:08000510
               ; .eh_frame:080005BC
             retn
main endp

```

.reserve() is inlined as well. It calls new() if the buffer is too small for the new size, calls memmove() to copy the contents of the buffer, and calls delete() to free the old buffer.

Let's also see what the compiled program outputs if compiled with GCC:

```

_Myfirst=0x(nil), _Mylast=0x(nil), _Myend=0x(nil)
size=0, capacity=0
_Myfirst=0x8257008, _Mylast=0x825700c, _Myend=0x825700c
size=1, capacity=1
element 0: 1
_Myfirst=0x8257018, _Mylast=0x8257020, _Myend=0x8257020
size=2, capacity=2
element 0: 1
element 1: 2
_Myfirst=0x8257028, _Mylast=0x8257034, _Myend=0x8257038
size=3, capacity=4
element 0: 1
element 1: 2
element 2: 3
_Myfirst=0x8257028, _Mylast=0x8257038, _Myend=0x8257038
size=4, capacity=4
element 0: 1
element 1: 2
element 2: 3
element 3: 4
_Myfirst=0x8257040, _Mylast=0x8257050, _Myend=0x8257058
size=4, capacity=6
element 0: 1
element 1: 2
element 2: 3
element 3: 4
_Myfirst=0x8257040, _Mylast=0x8257054, _Myend=0x8257058
size=5, capacity=6
element 0: 1
element 1: 2
element 2: 3
element 3: 4
element 4: 5
_Myfirst=0x8257040, _Mylast=0x8257058, _Myend=0x8257058
size=6, capacity=6
element 0: 1
element 1: 2
element 2: 3
element 3: 4
element 4: 5
element 5: 6
6
0

```

We can spot that the buffer size grows in a different way that in MSVC.

Simple experimentation shows that in MSVC's implementation the buffer grows by ~50% each time it needs to be enlarged, while GCC's code enlarges it by 100% each time, i.e., doubles it.

## std::map and std::set

The binary tree is another fundamental data structure.

As its name states, this is a tree where each node has at most 2 links to other nodes. Each node has key and/or value: `std::set` provides only key at each node, `std::map` provides both key and value at each node.

Binary trees are usually the structure used in the implementation of "dictionaries" of key-values (AKA "associative arrays").

There are at least three important properties that a binary trees has:

- All keys are always stored in sorted form.
- Keys of any types can be stored easily. Binary tree algorithms are unaware of the key's type, only a key comparison function is required.
- Finding a specific key is relatively fast in comparison with lists and arrays.

Here is a very simple example: let's store these numbers in a binary tree: 0, 1, 2, 3, 5, 6, 9, 10, 11, 12, 20, 99, 100, 101, 107, 1001, 1010.

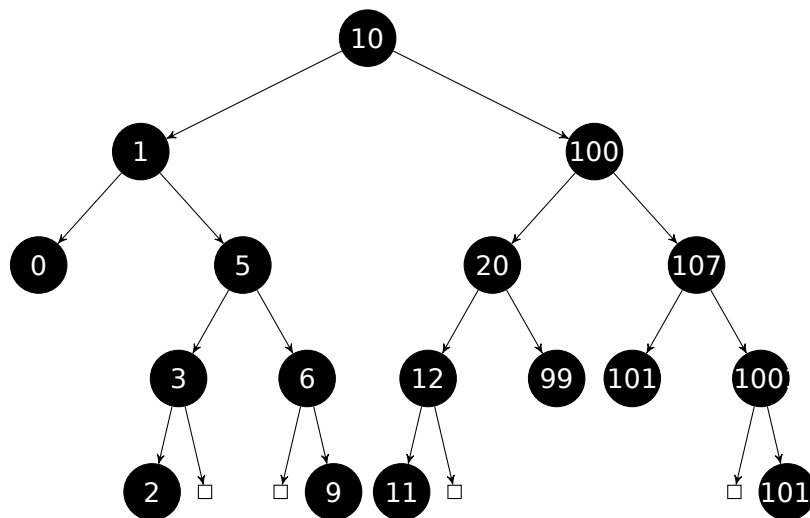

All keys that are smaller than the node key's value are stored on the left side.

All keys that are bigger than the node key's value are stored on the right side.

Hence, the lookup algorithm is straightforward: if the value that you are looking for is smaller than the current node's key value: move left, if it is bigger: move right, stop if the value required is equal to the node key's value.

That is why the searching algorithm may search for numbers, text strings, etc., as long as a key comparison function is provided.

All keys have unique values.

Having that, one needs  $\approx \log_2 n$  steps in order to find a key in a balanced binary tree with  $n$  keys. This implies that  $\approx 10$  steps are needed  $\approx 1000$  keys, or  $\approx 13$  steps for  $\approx 10000$  keys.

Not bad, but the tree has always to be balanced for this: i.e., the keys has to be distributed evenly on all levels. The insertion and removal operations do some maintenance to keep the tree in a balanced state.

There are several popular balancing algorithms available, including the AVL tree and the red-black tree.

The latter extends each node with a "color" value to simplify the balancing process, hence, each node may be "red" or "black".

Both GCC's and MSVC's `std::map` and `std::set` template implementations use red-black trees.

`std::set` has only keys. `std::map` is the "extended" version of `std::set`: it also has a value at each node.



```

};
};

void dump_map_and_set(struct tree_struct *m, bool is_set)
{
    printf ("ptr=0x%p, Myhead=0x%p, Mysize=%d\n", m, m->Myhead, m->Mysize);
    dump_tree_node (m->Myhead, is_set, true);
    printf ("As a tree:\n");
    printf ("root----");
    dump_as_tree (1, m->Myhead->Parent, is_set);
};

int main()
{
    // map

    std::map<int, const char*> m;

    m[10]="ten";
    m[20]="twenty";
    m[3]="three";
    m[101]="one hundred one";
    m[100]="one hundred";
    m[12]="twelve";
    m[107]="one hundred seven";
    m[0]="zero";
    m[1]="one";
    m[6]="six";
    m[99]="ninety-nine";
    m[5]="five";
    m[11]="eleven";
    m[1001]="one thousand one";
    m[1010]="one thousand ten";
    m[2]="two";
    m[9]="nine";
    printf ("dumping m as map:\n");
    dump_map_and_set ((struct tree_struct *) (void*)&m, false);

    std::map<int, const char*>::iterator it1=m.begin();
    printf ("m.begin():\n");
    dump_tree_node ((struct tree_node *) (void*)&it1, false, false);
    it1=m.end();
    printf ("m.end():\n");
    dump_tree_node ((struct tree_node *) (void*)&it1, false, false);

    // set

    std::set<int> s;
    s.insert(123);
    s.insert(456);
    s.insert(11);
    s.insert(12);
    s.insert(100);
    s.insert(1001);
    printf ("dumping s as set:\n");
    dump_map_and_set ((struct tree_struct *) (void*)&s, true);
    std::set<int>::iterator it2=s.begin();
    printf ("s.begin():\n");
    dump_tree_node ((struct tree_node *) (void*)&it2, true, false);
    it2=s.end();
    printf ("s.end():\n");
    dump_tree_node ((struct tree_node *) (void*)&it2, true, false);
};

```

Listing 3.118: MSVC 2012

```

dumping m as map:
ptr=0x0020FE04, Myhead=0x005BB3A0, Mysize=17
ptr=0x005BB3A0 Left=0x005BB4A0 Parent=0x005BB3C0 Right=0x005BB580 Color=1 Isn1l=1
ptr=0x005BB3C0 Left=0x005BB4C0 Parent=0x005BB3A0 Right=0x005BB440 Color=1 Isn1l=0

```

```

first=10 second=[ten]
ptr=0x005BB4C0 Left=0x005BB4A0 Parent=0x005BB3C0 Right=0x005BB520 Color=1 Isnil=0
first=1 second=[one]
ptr=0x005BB4A0 Left=0x005BB3A0 Parent=0x005BB4C0 Right=0x005BB3A0 Color=1 Isnil=0
first=0 second=[zero]
ptr=0x005BB520 Left=0x005BB400 Parent=0x005BB4C0 Right=0x005BB4E0 Color=0 Isnil=0
first=5 second=[five]
ptr=0x005BB400 Left=0x005BB5A0 Parent=0x005BB520 Right=0x005BB3A0 Color=1 Isnil=0
first=3 second=[three]
ptr=0x005BB5A0 Left=0x005BB3A0 Parent=0x005BB400 Right=0x005BB3A0 Color=0 Isnil=0
first=2 second=[two]
ptr=0x005BB4E0 Left=0x005BB3A0 Parent=0x005BB520 Right=0x005BB5C0 Color=1 Isnil=0
first=6 second=[six]
ptr=0x005BB5C0 Left=0x005BB3A0 Parent=0x005BB4E0 Right=0x005BB3A0 Color=0 Isnil=0
first=9 second=[nine]
ptr=0x005BB440 Left=0x005BB3E0 Parent=0x005BB3C0 Right=0x005BB480 Color=1 Isnil=0
first=100 second=[one hundred]
ptr=0x005BB3E0 Left=0x005BB460 Parent=0x005BB440 Right=0x005BB500 Color=0 Isnil=0
first=20 second=[twenty]
ptr=0x005BB460 Left=0x005BB540 Parent=0x005BB3E0 Right=0x005BB3A0 Color=1 Isnil=0
first=12 second=[twelve]
ptr=0x005BB540 Left=0x005BB3A0 Parent=0x005BB460 Right=0x005BB3A0 Color=0 Isnil=0
first=11 second=[eleven]
ptr=0x005BB500 Left=0x005BB3A0 Parent=0x005BB3E0 Right=0x005BB3A0 Color=1 Isnil=0
first=99 second=[ninety-nine]
ptr=0x005BB480 Left=0x005BB420 Parent=0x005BB440 Right=0x005BB560 Color=0 Isnil=0
first=107 second=[one hundred seven]
ptr=0x005BB420 Left=0x005BB3A0 Parent=0x005BB480 Right=0x005BB3A0 Color=1 Isnil=0
first=101 second=[one hundred one]
ptr=0x005BB560 Left=0x005BB3A0 Parent=0x005BB480 Right=0x005BB580 Color=1 Isnil=0
first=1001 second=[one thousand one]
ptr=0x005BB580 Left=0x005BB3A0 Parent=0x005BB560 Right=0x005BB3A0 Color=0 Isnil=0
first=1010 second=[one thousand ten]

```

As a tree:

```

root----10 [ten]
  L-----1 [one]
    L-----0 [zero]
    R-----5 [five]
      L-----3 [three]
        L-----2 [two]
        R-----6 [six]
          R-----9 [nine]
  R-----100 [one hundred]
    L-----20 [twenty]
      L-----12 [twelve]
        L-----11 [eleven]
        R-----99 [ninety-nine]
    R-----107 [one hundred seven]
      L-----101 [one hundred one]
      R-----1001 [one thousand one]
        R-----1010 [one thousand ten]

```

m.begin():

```

ptr=0x005BB4A0 Left=0x005BB3A0 Parent=0x005BB4C0 Right=0x005BB3A0 Color=1 Isnil=0
first=0 second=[zero]

```

m.end():

```

ptr=0x005BB3A0 Left=0x005BB4A0 Parent=0x005BB3C0 Right=0x005BB580 Color=1 Isnil=1

```

dumping s as set:

```

ptr=0x0020FDfC, Myhead=0x005BB5E0, Mysize=6
ptr=0x005BB5E0 Left=0x005BB640 Parent=0x005BB600 Right=0x005BB6A0 Color=1 Isnil=1
ptr=0x005BB600 Left=0x005BB660 Parent=0x005BB5E0 Right=0x005BB620 Color=1 Isnil=0
first=123
ptr=0x005BB660 Left=0x005BB640 Parent=0x005BB600 Right=0x005BB680 Color=1 Isnil=0
first=12
ptr=0x005BB640 Left=0x005BB5E0 Parent=0x005BB660 Right=0x005BB5E0 Color=0 Isnil=0
first=11
ptr=0x005BB680 Left=0x005BB5E0 Parent=0x005BB660 Right=0x005BB5E0 Color=0 Isnil=0
first=100
ptr=0x005BB620 Left=0x005BB5E0 Parent=0x005BB600 Right=0x005BB6A0 Color=1 Isnil=0
first=456

```



```

ptr=0x005BB6A0 Left=0x005BB5E0 Parent=0x005BB620 Right=0x005BB5E0 Color=0 Isn1l=0
first=1001
As a tree:
root----123
    L-----12
        L-----11
        R-----100
    R-----456
        R-----1001
s.begin():
ptr=0x005BB640 Left=0x005BB5E0 Parent=0x005BB660 Right=0x005BB5E0 Color=0 Isn1l=0
first=11
s.end():
ptr=0x005BB5E0 Left=0x005BB640 Parent=0x005BB600 Right=0x005BB6A0 Color=1 Isn1l=1

```

The structure is not packed, so both *char* values occupy 4 bytes each.

As for `std::map`, `first` and `second` can be viewed as a single value of type `std::pair`. `std::set` has only one value at this address in the structure instead.

The current size of the tree is always present, as in the case of the implementation of `std::list` in MSVC ([3.21.4 on page 576](#)).

As in the case of `std::list`, the iterators are just pointers to nodes. The `.begin()` iterator points to the minimal key.

That pointer is not stored anywhere (as in lists), the minimal key of the tree is looked up every time. `operator--` and `operator++` move the current node pointer to the predecessor or successor respectively, i.e., the nodes which have the previous or next key.

The algorithms for all these operations are explained in [Cormen, Thomas H. and Leiserson, Charles E. and Rivest, Ronald L. and Stein, Clifford, *Introduction to Algorithms, Third Edition*, (2009)].

The `.end()` iterator points to the dummy node, it has 1 in `Isn1l`, which implies that the node has no key and/or value. It can be viewed as a “landing zone” in HDD<sup>33</sup> and often called *sentinel* [see N. Wirth, *Algorithms and Data Structures*, 1985]<sup>34</sup>.

The “parent” field of the dummy node points to the root node, which serves as a vertex of the tree and contains information.

## GCC

```

#include <stdio.h>
#include <map>
#include <set>
#include <string>
#include <iostream>

struct map_pair
{
    int key;
    const char *value;
};

struct tree_node
{
    int M_color; // 0 - Red, 1 - Black
    struct tree_node *M_parent;
    struct tree_node *M_left;
    struct tree_node *M_right;
};

struct tree_struct
{
    int M_key_compare;
    struct tree_node M_header;
    size_t M_node_count;
};

```

<sup>33</sup>Hard Disk Drive

<sup>34</sup><http://www.ethoberon.ethz.ch/WirthPubl/AD.pdf>



```

std::map<int, const char*> m;

m[10]="ten";
m[20]="twenty";
m[3]="three";
m[101]="one hundred one";
m[100]="one hundred";
m[12]="twelve";
m[107]="one hundred seven";
m[0]="zero";
m[1]="one";
m[6]="six";
m[99]="ninety-nine";
m[5]="five";
m[11]="eleven";
m[1001]="one thousand one";
m[1010]="one thousand ten";
m[2]="two";
m[9]="nine";

printf ("dumping m as map:\n");
dump_map_and_set ((struct tree_struct *) (void*)&m, false);

std::map<int, const char*>::iterator it1=m.begin();
printf ("m.begin():\n");
dump_tree_node ((struct tree_node *) (void*)&it1, false, false, true);
it1=m.end();
printf ("m.end():\n");
dump_tree_node ((struct tree_node *) (void*)&it1, false, false, false);

// set

std::set<int> s;
s.insert(123);
s.insert(456);
s.insert(11);
s.insert(12);
s.insert(100);
s.insert(1001);
printf ("dumping s as set:\n");
dump_map_and_set ((struct tree_struct *) (void*)&s, true);
std::set<int>::iterator it2=s.begin();
printf ("s.begin():\n");
dump_tree_node ((struct tree_node *) (void*)&it2, true, false, true);
it2=s.end();
printf ("s.end():\n");
dump_tree_node ((struct tree_node *) (void*)&it2, true, false, false);
};

```

Listing 3.119: GCC 4.8.1

```

dumping m as map:
ptr=0x0028FE3C, M_key_compare=0x402b70, M_header=0x0028FE40, M_node_count=17
ptr=0x007A4988 M_left=0x007A4C00 M_parent=0x0028FE40 M_right=0x007A4B80 M_color=1
key=10 value=[ten]
ptr=0x007A4C00 M_left=0x007A4BE0 M_parent=0x007A4988 M_right=0x007A4C60 M_color=1
key=1 value=[one]
ptr=0x007A4BE0 M_left=0x00000000 M_parent=0x007A4C00 M_right=0x00000000 M_color=1
key=0 value=[zero]
ptr=0x007A4C60 M_left=0x007A4B40 M_parent=0x007A4C00 M_right=0x007A4C20 M_color=0
key=5 value=[five]
ptr=0x007A4B40 M_left=0x007A4CE0 M_parent=0x007A4C60 M_right=0x00000000 M_color=1
key=3 value=[three]
ptr=0x007A4CE0 M_left=0x00000000 M_parent=0x007A4B40 M_right=0x00000000 M_color=0
key=2 value=[two]
ptr=0x007A4C20 M_left=0x00000000 M_parent=0x007A4C60 M_right=0x007A4D00 M_color=1
key=6 value=[six]
ptr=0x007A4D00 M_left=0x00000000 M_parent=0x007A4C20 M_right=0x00000000 M_color=0
key=9 value=[nine]
ptr=0x007A4B80 M_left=0x007A49A8 M_parent=0x007A4988 M_right=0x007A4BC0 M_color=1

```

```

key=100 value=[one hundred]
ptr=0x007A49A8 M_left=0x007A4BA0 M_parent=0x007A4B80 M_right=0x007A4C40 M_color=0
key=20 value=[twenty]
ptr=0x007A4BA0 M_left=0x007A4C80 M_parent=0x007A49A8 M_right=0x00000000 M_color=1
key=12 value=[twelve]
ptr=0x007A4C80 M_left=0x00000000 M_parent=0x007A4BA0 M_right=0x00000000 M_color=0
key=11 value=[eleven]
ptr=0x007A4C40 M_left=0x00000000 M_parent=0x007A49A8 M_right=0x00000000 M_color=1
key=99 value=[ninety-nine]
ptr=0x007A4BC0 M_left=0x007A4B60 M_parent=0x007A4B80 M_right=0x007A4CA0 M_color=0
key=107 value=[one hundred seven]
ptr=0x007A4B60 M_left=0x00000000 M_parent=0x007A4BC0 M_right=0x00000000 M_color=1
key=101 value=[one hundred one]
ptr=0x007A4CA0 M_left=0x00000000 M_parent=0x007A4BC0 M_right=0x007A4CC0 M_color=1
key=1001 value=[one thousand one]
ptr=0x007A4CC0 M_left=0x00000000 M_parent=0x007A4CA0 M_right=0x00000000 M_color=0
key=1010 value=[one thousand ten]

```

As a tree:

```

root----10 [ten]
  L-----1 [one]
    L-----0 [zero]
    R-----5 [five]
      L-----3 [three]
        L-----2 [two]
        R-----6 [six]
          R-----9 [nine]
  R-----100 [one hundred]
    L-----20 [twenty]
      L-----12 [twelve]
        L-----11 [eleven]
        R-----99 [ninety-nine]
      R-----107 [one hundred seven]
        L-----101 [one hundred one]
        R-----1001 [one thousand one]
          R-----1010 [one thousand ten]

```

m.begin():

```

ptr=0x007A4BE0 M_left=0x00000000 M_parent=0x007A4C00 M_right=0x00000000 M_color=1
key=0 value=[zero]

```

m.end():

```

ptr=0x0028FE40 M_left=0x007A4BE0 M_parent=0x007A4988 M_right=0x007A4CC0 M_color=0

```

dumping s as set:

```

ptr=0x0028FE20, M_key_compare=0x8, M_header=0x0028FE24, M_node_count=6
ptr=0x007A1E80 M_left=0x01D5D890 M_parent=0x0028FE24 M_right=0x01D5D850 M_color=1
key=123
ptr=0x01D5D890 M_left=0x01D5D870 M_parent=0x007A1E80 M_right=0x01D5D8B0 M_color=1
key=12
ptr=0x01D5D870 M_left=0x00000000 M_parent=0x01D5D890 M_right=0x00000000 M_color=0
key=11
ptr=0x01D5D8B0 M_left=0x00000000 M_parent=0x01D5D890 M_right=0x00000000 M_color=0
key=100
ptr=0x01D5D850 M_left=0x00000000 M_parent=0x007A1E80 M_right=0x01D5D8D0 M_color=1
key=456
ptr=0x01D5D8D0 M_left=0x00000000 M_parent=0x01D5D850 M_right=0x00000000 M_color=0
key=1001

```

As a tree:

```

root----123
  L-----12
    L-----11
    R-----100
  R-----456
    R-----1001

```

s.begin():

```

ptr=0x01D5D870 M_left=0x00000000 M_parent=0x01D5D890 M_right=0x00000000 M_color=0
key=11

```

s.end():

```

ptr=0x0028FE24 M_left=0x01D5D870 M_parent=0x007A1E80 M_right=0x01D5D8D0 M_color=0

```

GCC's implementation is very similar <sup>35</sup>. The only difference is the absence of the `Isn1l` field, so the structure occupies slightly less space in memory than its implementation in MSVC.

The dummy node is also used as a place to point the `.end()` iterator also has no key and/or value.

### Rebalancing demo (GCC)

Here is also a demo showing us how a tree is rebalanced after some insertions.

Listing 3.120: GCC

```
#include <stdio.h>
#include <map>
#include <set>
#include <string>
#include <iostream>

struct map_pair
{
    int key;
    const char *value;
};

struct tree_node
{
    int M_color; // 0 - Red, 1 - Black
    struct tree_node *M_parent;
    struct tree_node *M_left;
    struct tree_node *M_right;
};

struct tree_struct
{
    int M_key_compare;
    struct tree_node M_header;
    size_t M_node_count;
};

const char* ALOT_OF_TABS="\t\t\t\t\t\t\t\t\t\t\t\t\t\t\t\t\t";

void dump_as_tree (int tabs, struct tree_node *n)
{
    void *point_after_struct=((char*)n)+sizeof(struct tree_node);

    printf ("%d\n", *(int*)point_after_struct);

    if (n->M_left)
    {
        printf (".*sL-----", tabs, ALOT_OF_TABS);
        dump_as_tree (tabs+1, n->M_left);
    };
    if (n->M_right)
    {
        printf (".*sR-----", tabs, ALOT_OF_TABS);
        dump_as_tree (tabs+1, n->M_right);
    };
};

void dump_map_and_set(struct tree_struct *m)
{
    printf ("root----");
    dump_as_tree (1, m->M_header.M_parent);
};

int main()
{
    std::set<int> s;
    s.insert(123);
```

<sup>35</sup><http://go.yurichev.com/17084>

```

s.insert(456);
printf ("123, 456 has been inserted\n");
dump_map_and_set ((struct tree_struct *) (void*)&s);
s.insert(11);
s.insert(12);
printf ("\n");
printf ("11, 12 has been inserted\n");
dump_map_and_set ((struct tree_struct *) (void*)&s);
s.insert(100);
s.insert(1001);
printf ("\n");
printf ("100, 1001 has been inserted\n");
dump_map_and_set ((struct tree_struct *) (void*)&s);
s.insert(667);
s.insert(1);
s.insert(4);
s.insert(7);
printf ("\n");
printf ("667, 1, 4, 7 has been inserted\n");
dump_map_and_set ((struct tree_struct *) (void*)&s);
printf ("\n");
};

```

Listing 3.121: GCC 4.8.1

```

123, 456 has been inserted
root----123
      R-----456

11, 12 has been inserted
root----123
      L-----11
            R-----12
      R-----456

100, 1001 has been inserted
root----123
      L-----12
            L-----11
            R-----100
      R-----456
            R-----1001

667, 1, 4, 7 has been inserted
root----12
      L-----4
            L-----1
            R-----11
                  L-----7
      R-----123
            L-----100
            R-----667
                  L-----456
                  R-----1001

```

### 3.21.5 Memory

Sometimes you may hear from C++ programmers “allocate memory on stack” and/or “allocate memory on [heap](#)”.

Allocating object *on stack*:

```

void f()
{
    ...
    Class o=Class(...);
}

```

```
};    ...
```

The memory for object (or structure) is allocated in stack, using simple [SP](#) shift. The memory is deallocated upon function exit, or, more precisely, at the end of *scope*—[SP](#) is returning to its state (same as at the start of function) and destructor of *Class* is called. In the same manner, memory for allocated structure in C is deallocated upon function exit.

Allocating object *on heap*:

```
void f1()
{
    ...
    Class *o=new Class(...);
    ...
};

void f2()
{
    ...
    delete o;
    ...
};
```

This is the same as allocating memory for a structure using *malloc()* call. In fact, *new* in C++ is wrapper for *malloc()*, and *delete* is wrapper for *free()*. Since memory block has been allocated in [heap](#), it must be deallocated explicitly, using *delete*. Class destructor will be automatically called right before that moment.

Which method is better? Allocating *on stack* is very fast, and good for small, short-lived object, which will be used only in the current function.

Allocating *on heap* is slower, and better for long-lived object, which will be used across many functions. Also, objects allocated in [heap](#) are prone to memory leakage, because they must to be freed explicitly, but one can forget about it.

Anyway, this is matter of taste.

## 3.22 Negative array indices

It's possible to address the space *before* an array by supplying a negative index, e.g., *array[-1]*.

### 3.22.1 Addressing string from the end

Python [PL](#) allows to address arrays and strings from the end. For example, *string[-1]* returns the last character, *string[-2]* returns penultimate, etc. Hard to believe, but this is also possible in C/C++:

```
#include <string.h>
#include <stdio.h>

int main()
{
    char *s="Hello, world!";
    char *s_end=s+strlen(s);

    printf ("last character: %c\n", s_end[-1]);
    printf ("penultimate character: %c\n", s_end[-2]);
};
```

It works, but *s\_end* must always has an address of terminating zero byte at the end of *s* string. If *s* string's size get changed, *s\_end* must be updated.

The trick is dubious, but again, this is a demonstration of negative indices.

### 3.22.2 Addressing some kind of block from the end

Let's first recall why stack grows backwards ( 1.9.1 on page 30). There is some kind of block in memory and you want to store both heap and stack there, and you are not sure, how big they both can grow during runtime.

You can set a *heap* pointer to the beginning of the block, then you can set a *stack* pointer to the end of the block (*heap + size\_of\_block*), and then you can address *n*th element of stack like *stack[-n]*. For example, *stack[-1]* for 1st element, *stack[-2]* for 2nd, etc.

This will work in the same fashion, as our trick of addressing string from the end.

You can easily check if the structures has not begun to overlap each other: just be sure that address of the last element in *heap* is below the address of the last element of *stack*.

Unfortunately,  $-0$  as index will not work, since two's complement way of representing negative numbers ( 2.2 on page 452) don't allow negative zero, so it cannot be distinguished from positive zero.

This method is also mentioned in "Transaction processing", Jim Gray, 1993, "The Tuple-Oriented File System" chapter, p. 755.

### 3.22.3 Arrays started at 1

Fortran and Mathematica defined first element of array as 1th, probably because this is tradition in mathematics. Other PLs like C/C++ defined it as 0th. Which is better? Edsger W. Dijkstra argued that latter is better <sup>36</sup>.

But programmers may still have a habit after Fortran, so using this little trick, it's possible to address the first element in C/C++ using index 1:

```
#include <stdio.h>

int main()
{
    int random_value=0x11223344;
    unsigned char array[10];
    int i;
    unsigned char *fakearray=&array[-1];

    for (i=0; i<10; i++)
        array[i]=i;

    printf ("first element %d\n", fakearray[1]);
    printf ("second element %d\n", fakearray[2]);
    printf ("last element %d\n", fakearray[10]);

    printf ("array[-1]=%02X, array[-2]=%02X, array[-3]=%02X, array[-4]=%02X\n",
        array[-1],
        array[-2],
        array[-3],
        array[-4]);
};
```

Listing 3.122: Non-optimizing MSVC 2010

```
1 $SG2751 DB      'first element %d', 0aH, 00H
2 $SG2752 DB      'second element %d', 0aH, 00H
3 $SG2753 DB      'last element %d', 0aH, 00H
4 $SG2754 DB      'array[-1]=%02X, array[-2]=%02X, array[-3]=%02X, array[-4]'
5               DB      ']=%02X', 0aH, 00H
6
7 _fakearray$ = -24                ; size = 4
8 _random_value$ = -20            ; size = 4
9 _array$ = -16                   ; size = 10
10 _i$ = -4                       ; size = 4
11 _main PROC
12     push     ebp
13     mov     ebp, esp
14     sub     esp, 24
```

<sup>36</sup>See <https://www.cs.utexas.edu/users/EWD/transcriptions/EWD08xx/EWD831.html>



```

15     mov     DWORD PTR _random_value$[ebp], 287454020 ; 11223344H
16     ; set fakearray[] one byte earlier before array[]
17     lea     eax, DWORD PTR _array$[ebp]
18     add     eax, -1 ; eax=eax-1
19     mov     DWORD PTR _fakearray$[ebp], eax
20     mov     DWORD PTR _i$[ebp], 0
21     jmp     SHORT $LN3@main
22     ; fill array[] with 0..9
23 $LN2@main:
24     mov     ecx, DWORD PTR _i$[ebp]
25     add     ecx, 1
26     mov     DWORD PTR _i$[ebp], ecx
27 $LN3@main:
28     cmp     DWORD PTR _i$[ebp], 10
29     jge     SHORT $LN1@main
30     mov     edx, DWORD PTR _i$[ebp]
31     mov     al, BYTE PTR _i$[ebp]
32     mov     BYTE PTR _array$[ebp+edx], al
33     jmp     SHORT $LN2@main
34 $LN1@main:
35     mov     ecx, DWORD PTR _fakearray$[ebp]
36     ; ecx=address of fakearray[0], ecx+1 is fakearray[1] or array[0]
37     movzx   edx, BYTE PTR [ecx+1]
38     push   edx
39     push   OFFSET $SG2751 ; 'first element %d'
40     call   _printf
41     add     esp, 8
42     mov     eax, DWORD PTR _fakearray$[ebp]
43     ; eax=address of fakearray[0], eax+2 is fakearray[2] or array[1]
44     movzx   ecx, BYTE PTR [eax+2]
45     push   ecx
46     push   OFFSET $SG2752 ; 'second element %d'
47     call   _printf
48     add     esp, 8
49     mov     edx, DWORD PTR _fakearray$[ebp]
50     ; edx=address of fakearray[0], edx+10 is fakearray[10] or array[9]
51     movzx   eax, BYTE PTR [edx+10]
52     push   eax
53     push   OFFSET $SG2753 ; 'last element %d'
54     call   _printf
55     add     esp, 8
56     ; subtract 4, 3, 2 and 1 from pointer to array[0] in order to find values before array[]
57     lea     ecx, DWORD PTR _array$[ebp]
58     movzx   edx, BYTE PTR [ecx-4]
59     push   edx
60     lea     eax, DWORD PTR _array$[ebp]
61     movzx   ecx, BYTE PTR [eax-3]
62     push   ecx
63     lea     edx, DWORD PTR _array$[ebp]
64     movzx   eax, BYTE PTR [edx-2]
65     push   eax
66     lea     ecx, DWORD PTR _array$[ebp]
67     movzx   edx, BYTE PTR [ecx-1]
68     push   edx
69     push   OFFSET $SG2754 ;
70     'array[-1]=%02X, array[-2]=%02X, array[-3]=%02X, array[-4]=%02X'
71     call   _printf
72     add     esp, 20
73     xor     eax, eax
74     mov     esp, ebp
75     pop     ebp
76     ret     0
_main   ENDP

```

So we have array[] of ten elements, filled with 0...9 bytes.

Then we have the fakearray[] pointer, which points one byte before array[].

fakearray[1] points exactly to array[0]. But we are still curious, what is there before array[]? We have added random\_value before array[] and set it to 0x11223344. The non-optimizing compiler allocated

the variables in the order they were declared, so yes, the 32-bit `random_value` is right before the array. We ran it, and:

```
first element 0
second element 1
last element 9
array[-1]=11, array[-2]=22, array[-3]=33, array[-4]=44
```

Here is the stack fragment we will copy/paste from OllyDbg's stack window (with comments added by the author):

Listing 3.123: Non-optimizing MSVC 2010

```
CPU Stack
Address  Value
001DFBCC /001DFBD3 ; fakearray pointer
001DFBD0 |11223344 ; random_value
001DFBD4 |03020100 ; 4 bytes of array[]
001DFBD8 |07060504 ; 4 bytes of array[]
001DFBDC |00CB0908 ; random garbage + 2 last bytes of array[]
001DFBE0 |0000000A ; last i value after loop was finished
001DFBE4 |001DFC2C ; saved EBP value
001DFBE8 \00CB129D ; Return Address
```

The pointer to the `fakearray[]` (`0x001DFBD3`) is indeed the address of `array[]` in the stack (`0x001DFBD4`), but minus 1 byte.

It's still very hackish and dubious trick. Doubtfully anyone should use it in production code, but as a demonstration, it fits perfectly here.

## 3.23 More about pointers

The way C handles pointers, for example, was a brilliant innovation; it solved a lot of problems that we had before in data structuring and made the programs look good afterwards.

Donald Knuth, interview (1993)

For those, who still have hard time understanding C/C++ pointers, here are more examples. Some of them are weird and serves only demonstration purpose: use them in production code only if you really know what you're doing.

### 3.23.1 Working with addresses instead of pointers

Pointer is just an address in memory. But why we write `char* string` instead of something like `address string`? Pointer variable is supplied with a type of the value to which pointer points. So then compiler will be able to catch data typization bugs during compilation.

To be pedantic, data typing in programming languages is all about preventing bugs and self-documentation. It's possible to use maybe two of data types like `int` (or `int64_t`) and `byte`—these are the only types which are available to assembly language programmers. But it's just very hard task to write big and practical assembly programs without nasty bugs. Any small typo can lead to hard-to-find bug.

Data type information is absent in a compiled code (and this is one of the main problems for decompilers), and I can demonstrate this.

This is what sane C/C++ programmer can write:

```
#include <stdio.h>
#include <stdint.h>

void print_string (char *s)
{
```

```

        printf ("(address: 0x%llx)\n", s);
        printf ("%s\n", s);
};

int main()
{
    char *s="Hello, world!";

    print_string (s);
};

```

This is what I can write:

```

#include <stdio.h>
#include <stdint.h>

void print_string (uint64_t address)
{
    printf ("(address: 0x%llx)\n", address);
    puts ((char*)address);
};

int main()
{
    char *s="Hello, world!";

    print_string ((uint64_t)s);
};

```

I use *uint64\_t* because I run this example on Linux x64. *int* would work for 32-bit OS-es. First, a pointer to character (the very first in the greeting string) is casted to *uint64\_t*, then it's passed further. *print\_string()* function casts back incoming *uint64\_t* value into pointer to a character.

What is interesting is that GCC 4.8.4 produces identical assembly output for both versions:

```
gcc 1.c -S -masm=intel -O3 -fno-inline
```

```

.LC0:
    .string "(address: 0x%llx)\n"
print_string:
    push    rbx
    mov     rdx, rdi
    mov     rbx, rdi
    mov     esi, OFFSET FLAT:.LC0
    mov     edi, 1
    xor     eax, eax
    call   __printf_chk
    mov     rdi, rbx
    pop     rbx
    jmp     puts
.LC1:
    .string "Hello, world!"
main:
    sub     rsp, 8
    mov     edi, OFFSET FLAT:.LC1
    call   print_string
    add     rsp, 8
    ret

```

(I've removed all insignificant GCC directives.)

I also tried UNIX *diff* utility and it shows no differences at all.

Let's continue to abuse C/C++ programming traditions heavily. Someone may write this:

```

#include <stdio.h>
#include <stdint.h>

uint8_t load_byte_at_address (uint8_t* address)
{
    return *address;
    //this is also possible: return address[0];
};

void print_string (char *s)
{
    char* current_address=s;
    while (1)
    {
        char current_char=load_byte_at_address(current_address);
        if (current_char==0)
            break;
        printf ("%c", current_char);
        current_address++;
    };
};

int main()
{
    char *s="Hello, world!";

    print_string (s);
};

```

It can be rewritten like this:

```

#include <stdio.h>
#include <stdint.h>

uint8_t load_byte_at_address (uint64_t address)
{
    return *(uint8_t*)address;
};

void print_string (uint64_t address)
{
    uint64_t current_address=address;
    while (1)
    {
        char current_char=load_byte_at_address(current_address);
        if (current_char==0)
            break;
        printf ("%c", current_char);
        current_address++;
    };
};

int main()
{
    char *s="Hello, world!";

    print_string ((uint64_t)s);
};

```

Both source codes resulting in the same assembly output:

```
gcc 1.c -S -masm=intel -O3 -fno-inline
```

```
load_byte_at_address:
```

```

        movzx  eax, BYTE PTR [rdi]
        ret
print_string:
.LFB15:
        push  rbx
        mov   rbx, rdi
        jmp   .L4
.L7:
        movsx edi, al
        add   rbx, 1
        call  putchar
.L4:
        mov   rdi, rbx
        call  load_byte_at_address
        test  al, al
        jne  .L7
        pop  rbx
        ret
.LC0:
        .string "Hello, world!"
main:
        sub   rsp, 8
        mov   edi, OFFSET FLAT:.LC0
        call  print_string
        add   rsp, 8
        ret

```

(I have also removed all insignificant GCC directives.)

No difference: C/C++ pointers are essentially addresses, but supplied with type information, in order to prevent possible mistakes at the time of compilation. Types are not checked during runtime—it would be huge (and unneeded) overhead.

### 3.23.2 Passing values as pointers; tagged unions

Here is an example on how to pass values in pointers:

```

#include <stdio.h>
#include <stdint.h>

uint64_t multiply1 (uint64_t a, uint64_t b)
{
    return a*b;
};

uint64_t* multiply2 (uint64_t *a, uint64_t *b)
{
    return (uint64_t*)((uint64_t)a*(uint64_t)b);
};

int main()
{
    printf ("%d\n", multiply1(123, 456));
    printf ("%d\n", (uint64_t)multiply2((uint64_t*)123, (uint64_t*)456));
};

```

It works smoothly and GCC 4.8.4 compiles both multiply1() and multiply2() functions identically!

```

multiply1:
        mov   rax, rdi
        imul rax, rsi
        ret

multiply2:
        mov   rax, rdi
        imul rax, rsi

```

```
ret
```

As long as you do not dereference pointer (in other words, you don't read any data from the address stored in pointer), everything will work fine. Pointer is a variable which can store anything, like usual variable.

Signed multiplication instruction (IMUL) is used here instead of unsigned one (MUL), read more about it here: [2.2.1 on page 454](#).

By the way, it's well-known hack to abuse pointers a little called *tagged pointers*. In short, if all your pointers points to blocks of memory with size of, let's say, 16 bytes (or it is always aligned on 16-byte boundary), 4 lowest bits of pointer is always zero bits and this space can be used somehow. It's very popular in LISP compilers and interpreters. They store cell/object type in these unused bits, this can save some memory. Even more, you can judge about cell/object type using just pointer, with no additional memory access. Read more about it: [Dennis Yurichev, *C/C++ programming language notes*1.3].

### 3.23.3 Pointers abuse in Windows kernel

The resource section of PE executable file in Windows OS is a section containing pictures, icons, strings, etc. Early Windows versions allowed to address resources only by IDs, but then Microsoft added a way to address them using strings.

So then it would be possible to pass ID or string to `FindResource()` function. Which is declared like this:

```
HRSRC WINAPI FindResource(
    _In_opt_ HMODULE hModule,
    _In_     LPCTSTR lpName,
    _In_     LPCTSTR lpType
);
```

`lpName` and `lpType` has `char*` or `wchar*` types, and when someone still wants to pass ID, he/she have to use `MAKEINTRESOURCE` macro, like this:

```
result = FindResource(..., MAKEINTRESOURCE(1234), ...);
```

It's interesting fact that `MAKEINTRESOURCE` is merely casting integer to pointer. In MSVC 2013, in the file `Microsoft SDKs\Windows\v7.1A\Include\Ks.h` we can find this:

```
...
#if (!defined( MAKEINTRESOURCE ))
#define MAKEINTRESOURCE( res ) ((ULONG_PTR) (USHORT) res)
#endif
...
```

Sounds insane. Let's peek into ancient leaked Windows NT4 source code. In `private/windows/base/client/module.c` we can find `FindResource()` source code:

```
HRSRC
FindResourceA(
    HMODULE hModule,
    LPCSTR lpName,
    LPCSTR lpType
)
...
{
    NTSTATUS Status;
    ULONG IdPath[ 3 ];
    PVOID p;
```

```

IdPath[ 0 ] = 0;
IdPath[ 1 ] = 0;
try {
    if ((IdPath[ 0 ] = BaseDllMapResourceIdA( lpType )) == -1) {
        Status = STATUS_INVALID_PARAMETER;
    }
    else
    if ((IdPath[ 1 ] = BaseDllMapResourceIdA( lpName )) == -1) {
        Status = STATUS_INVALID_PARAMETER;
    }
}
...

```

Let's proceed to *BaseDllMapResourceIdA()* in the same source file:

```

ULONG
BaseDllMapResourceIdA(
    LPCSTR lpId
)
{
    NTSTATUS Status;
    ULONG Id;
    UNICODE_STRING UnicodeString;
    ANSI_STRING AnsiString;
    PWSTR s;

    try {
        if ((ULONG)lpId & LDR_RESOURCE_ID_NAME_MASK) {
            if (*lpId == '#') {
                Status = RtlCharToInteger( lpId+1, 10, &Id );
                if (!NT_SUCCESS( Status ) || Id & LDR_RESOURCE_ID_NAME_MASK) {
                    if (NT_SUCCESS( Status )) {
                        Status = STATUS_INVALID_PARAMETER;
                    }
                    BaseSetLastNTErrror( Status );
                    Id = (ULONG)-1;
                }
            }
            else {
                RtlInitAnsiString( &AnsiString, lpId );
                Status = RtlAnsiStringToUnicodeString( &UnicodeString,
                                                       &AnsiString,
                                                       TRUE );

                if (!NT_SUCCESS( Status )){
                    BaseSetLastNTErrror( Status );
                    Id = (ULONG)-1;
                }
                else {
                    s = UnicodeString.Buffer;
                    while (*s != UNICODE_NULL) {
                        *s = RtlUpcaseUnicodeChar( *s );
                        s++;
                    }

                    Id = (ULONG)UnicodeString.Buffer;
                }
            }
        }
        else {
            Id = (ULONG)lpId;
        }
    }
    except (EXCEPTION_EXECUTE_HANDLER) {
        BaseSetLastNTErrror( GetExceptionCode() );
        Id = (ULONG)-1;
    }
    return Id;
}

```

*lpId* is ANDed with *LDR\_RESOURCE\_ID\_NAME\_MASK*.  
Which we can find in *public/sdk/inc/ntldr.h*:

```
...
#define LDR_RESOURCE_ID_NAME_MASK 0xFFFF0000
...
```

So *lpId* is ANDed with *0xFFFF0000* and if some bits beyond lowest 16 bits are still present, first half of function is executed (*lpId* is treated as an address of string). Otherwise—second half (*lpId* is treated as 16-bit value).

Still, this code can be found in Windows 7 kernel32.dll file:

```
....
.text:0000000078D24510 ; __int64 __fastcall BaseDllMapResourceIdA(PCSZ SourceString)
.text:0000000078D24510 BaseDllMapResourceIdA proc near ; CODE XREF: FindResourceExA+34
.text:0000000078D24510 ; FindResourceExA+4B
.text:0000000078D24510
.text:0000000078D24510 var_38 = qword ptr -38h
.text:0000000078D24510 var_30 = qword ptr -30h
.text:0000000078D24510 var_28 = _UNICODE_STRING ptr -28h
.text:0000000078D24510 DestinationString= _STRING ptr -18h
.text:0000000078D24510 arg_8 = dword ptr 10h
.text:0000000078D24510
.text:0000000078D24510 ; FUNCTION CHUNK AT .text:0000000078D42FB4 SIZE 00000005 BYTES
.text:0000000078D24510
.text:0000000078D24510 push rbx
.text:0000000078D24512 sub rsp, 50h
.text:0000000078D24516 cmp rcx, 10000h
.text:0000000078D2451D jnb loc_78D42FB4
.text:0000000078D24523 mov [rsp+58h+var_38], rcx
.text:0000000078D24528 jmp short $+2
.text:0000000078D2452A ;
-----
.text:0000000078D2452A
.text:0000000078D2452A loc_78D2452A: ; CODE XREF:
BaseDllMapResourceIdA+18
.text:0000000078D2452A ; BaseDllMapResourceIdA+1EAD0
.text:0000000078D2452A jmp short $+2
.text:0000000078D2452C ;
-----
.text:0000000078D2452C
.text:0000000078D2452C loc_78D2452C: ;
CODE XREF: BaseDllMapResourceIdA:loc_78D2452A
.text:0000000078D2452C ; BaseDllMapResourceIdA+1EB74
.text:0000000078D2452C mov rax, rcx
.text:0000000078D2452F add rsp, 50h
.text:0000000078D24533 pop rbx
.text:0000000078D24534 retn
.text:0000000078D24534 ;
-----
.text:0000000078D24535 align 20h
.text:0000000078D24535 BaseDllMapResourceIdA endp
....
.text:0000000078D42FB4 loc_78D42FB4: ; CODE XREF:
BaseDllMapResourceIdA+D
.text:0000000078D42FB4 cmp byte ptr [rcx], '#'
.text:0000000078D42FB7 jnz short loc_78D43005
.text:0000000078D42FB9 inc rcx
.text:0000000078D42FBC lea r8, [rsp+58h+arg_8]
.text:0000000078D42FC1 mov edx, 0Ah
.text:0000000078D42FC6 call cs:__imp_RtlCharToInteger
.text:0000000078D42FCC mov ecx, [rsp+58h+arg_8]
.text:0000000078D42FD0 mov [rsp+58h+var_38], rcx
.text:0000000078D42FD5 test eax, eax
.text:0000000078D42FD7 js short loc_78D42FE6
.text:0000000078D42FD9 test rcx, 0FFFFFFFFFFFFFF0000h
```



```
.text:0000000078D42FE0          jz      loc_78D2452A
....
```

If value in input pointer is greater than 0x10000, jump to string processing is occurred. Otherwise, input value of *lpId* is returned as is. 0xFFFF0000 mask is not used here any more, because this is 64-bit code after all, but still, 0xFFFFFFFF0000 could work here.

Attentive reader may ask, what if address of input string is lower than 0x10000? This code relied on the fact that in Windows there are nothing on addresses below 0x10000, at least in Win32 realm.

Raymond Chen [writes](#) about this:

How does MAKEINTRESOURCE work? It just stashes the integer in the bottom 16 bits of a pointer, leaving the upper bits zero. This relies on the convention that the first 64KB of address space is never mapped to valid memory, a convention that is enforced starting in Windows 7.

In short words, this is dirty hack and probably one should use it only if there is a real necessity. Perhaps, *FindResource()* function in past had *SHORT* type for its arguments, and then Microsoft has added a way to pass strings there, but older code must also be supported.

Now here is my short distilled example:

```
#include <stdio.h>
#include <stdint.h>

void f(char* a)
{
    if (((uint64_t)a)>0x10000)
        printf ("Pointer to string has been passed: %s\n", a);
    else
        printf ("16-bit value has been passed: %d\n", (uint64_t)a);
};

int main()
{
    f("Hello!"); // pass string
    f((char*)1234); // pass 16-bit value
};
```

It works!

## Pointers abuse in Linux kernel

As it has been noted in [comments on Hacker News](#), Linux kernel also has something like that.

For example, this function can return both error code and pointer:

```
struct kernfs_node *kernfs_create_link(struct kernfs_node *parent,
                                      const char *name,
                                      struct kernfs_node *target)
{
    struct kernfs_node *kn;
    int error;

    kn = kernfs_new_node(parent, name, S_IFLNK|S_IRWXUGO, KERNFS_LINK);
    if (!kn)
        return ERR_PTR(-ENOMEM);

    if (kernfs_ns_enabled(parent))
        kn->ns = target->ns;
    kn->symlink.target_kn = target;
    kernfs_get(target); /* ref owned by symlink */

    error = kernfs_add_one(kn);
```

```

    if (!error)
        return kn;

    kernfs_put(kn);
    return ERR_PTR(error);
}

```

( <https://github.com/torvalds/linux/blob/fceef393a538134f03b778c5d2519e670269342f/fs/kernfs/symlink.c#L25> )

`ERR_PTR` is a macro to cast integer to pointer:

```

static inline void * __must_check ERR_PTR(long error)
{
    return (void *) error;
}

```

( <https://github.com/torvalds/linux/blob/61d0b5a4b2777dcf5daef245e212b3c1fa8091ca/tools/virtio/linux/err.h> )

This header file also has a macro helper to distinguish error code from pointer:

```

#define IS_ERR_VALUE(x) unlikely((x) >= (unsigned long)-MAX_ERRNO)

```

This means, error codes are the “pointers” which are very close to -1 and, hopefully, there are nothing in kernel memory on the addresses like 0xFFFFFFFFFFFFFFFF, 0xFFFFFFFFFFFFFFFE, 0xFFFFFFFFFFFFFFFD, etc.

Much more popular solution is to return `NULL` in case of error and to pass error code via additional argument. Linux kernel authors don’t do that, but everyone who use these functions must always keep in mind that returning pointer must always be checked with `IS_ERR_VALUE` before dereferencing.

For example:

```

fman->cam_offset = fman_muram_alloc(fman->muram, fman->cam_size);
if (IS_ERR_VALUE(fman->cam_offset)) {
    dev_err(fman->dev, "%s: MURAM alloc for DMA CAM failed\n",
            __func__);
    return -ENOMEM;
}

```

( <https://github.com/torvalds/linux/blob/aa00edc1287a693eadc7bc67a3d73555d969b35d/drivers/net/ethernet/freescale/fman/fman.c#L826> )

## Pointers abuse in UNIX userland

`mmap()` function returns -1 in case of error (or `MAP_FAILED`, which equals to -1). Some people say, `mmap()` can map a memory at zeroth address in rare situations, so it can’t use 0 or `NULL` as error code.

### 3.23.4 Null pointers

#### “Null pointer assignment” error of MS-DOS era

Oldschool readers may recall a weird error message of MS-DOS era: “Null pointer assignment”. What does it mean?

It’s not possible to write a memory at zero address in \*NIX and Windows OSes, but it was possible to do so in MS-DOS due to absence of memory protection whatsoever.

So I’ve pulled my ancient Turbo C++ 3.0 (later it was renamed to Borland C++) from early 1990s and tried to compile this:

```
#include <stdio.h>

int main()
{
    int *ptr=NULL;
    *ptr=1234;
    printf ("Now let's read at NULL\n");
    printf ("%d\n", *ptr);
};
```

Hard to believe, but it works, with error upon exit, though:

Listing 3.124: Ancient Turbo C 3.0

```
C:\TC30\BIN\1
Now let's read at NULL
1234
Null pointer assignment
C:\TC30\BIN>_
```

Let's dig deeper into the source code of [CRT](#) of Borland C++ 3.1, file *c0.asm*:

```
; _checknull()    check for null pointer zapping copyright message
...
; Check for null pointers before exit

__checknull      PROC    DIST
                  PUBLIC  __checknull

IF              LDATA  EQ  false
  IFNDEF        __TINY__
    push        si
    push        di
    mov         es, cs:DGROUP@@
    xor         ax, ax
    mov         si, ax
    mov         cx, lgth_CopyRight
ComputeChecksum  label  near
    add         al, es:[si]
    adc         ah, 0
    inc         si
    loop        ComputeChecksum
    sub         ax, CheckSum
    jz          @@SumOK
    mov         cx, lgth_NullCheck
    mov         dx, offset DGROUP: NullCheck
    call        ErrorDisplay
@@SumOK:         pop         di
                  pop         si
  ENDIF
ENDIF

_DATA            SEGMENT

; Magic symbol used by the debug info to locate the data segment
                  public  DATASEG@
DATASEG@         label  byte

; The Copyright string must NOT be moved or changed without
; changing the null pointer check logic

Copyright        db          4 dup(0)
                  db          'Borland C++ - Copyright 1991 Borland Intl.',0
lgth_CopyRight   equ         $ - Copyright
```

```

IF      LDATA  EQ  false
IFNDEF  __TINY__
Checksum      equ      00D5Ch
NullCheck     db       'Null pointer assignment', 13, 10
lgth_NullCheck equ     $ - NullCheck
ENDIF
ENDIF
...

```

The MS-DOS memory model was really weird ( [11.6 on page 1000](#)) and probably not worth looking into it unless you're fan of retrocomputing or retrogaming. One thing we have to keep in mind is that memory segment (included data segment) in MS-DOS is a memory segment in which code or data is stored, but unlike "serious" OSes, it's started at address 0.

And in Borland C++ [CRT](#), the data segment is started with 4 zero bytes and the copyright string "Borland C++ - Copyright 1991 Borland Intl.". The integrity of the 4 zero bytes and text string is checked upon exit, and if it's corrupted, the error message is displayed.

But why? Writing at null pointer is common mistake in C/C++, and if you do so in \*NIX or Windows, your application will crash. MS-DOS has no memory protection, so [CRT](#) has to check this post-factum and warn about it upon exit. If you see this message, this means, your program at some point has written at address 0.

Our program did so. And this is why 1234 number has been read correctly: because it was written at the place of the first 4 zero bytes. Checksum is incorrect upon exit (because the number has been left there), so error message has been displayed.

Am I right? I've rewritten the program to check my assumptions:

```

#include <stdio.h>

int main()
{
    int *ptr=NULL;
    *ptr=1234;
    printf ("Now let's read at NULL\n");
    printf ("%d\n", *ptr);
    *ptr=0; // psst, cover our tracks!
};

```

This program executes without error message upon exit.

Though method to warn about null pointer assignment is relevant for MS-DOS, perhaps, it can still be used today in low-cost [MCUs](#) with no memory protection and/or [MMU](#)<sup>37</sup>.

### Why would anyone write at address 0?

But why would sane programmer write a code which writes something at address 0? It can be done accidentally: for example, a pointer must be initialized to newly allocated memory block and then passed to some function which returns data through pointer.

```

int *ptr=NULL;

... we forgot to allocate memory and initialize ptr

strcpy (ptr, buf); // strcpy() terminates silently because MS-DOS has no memory protection

```

Even worse:

```

int *ptr=malloc(1000);

```

<sup>37</sup>Memory Management Unit

```
... we forgot to check if memory has been really allocated: this is MS-DOS after all and ↵
↳ computers had small amount of RAM,
... and RAM shortage was very common.
... if malloc() returned NULL, the ptr will also be NULL.
```

```
strcpy (ptr, buf); // strcpy() terminates silently because MS-DOS has no memory protection
```

## Writing on 0th address on purpose

Here is an example from `dmalloc`<sup>38</sup>, a portable way of generating core dump, if other ways are not available:

### 3.4 Generating a Core File on Errors

```
=====
```

If the ``error-abort'` debug token has been enabled, when the library detects any problems with the heap memory, it will immediately attempt to dump a core file. *\*Note Debug Tokens::*. Core files are a complete copy of the program and it's state and can be used by a debugger to see specifically what is going on when the error occurred. *\*Note Using With a Debugger::*. By default, the low, medium, and high arguments to the library utility enable the ``error-abort'` token. You can disable this feature by entering ``dmalloc -m error-abort'` (-m for minus) to remove the ``error-abort'` token and your program will just log errors and continue. You can also use the ``error-dump'` token which tries to dump core when it sees an error but still continue running. *\*Note Debug Tokens::*.

When a program dumps core, the system writes the program and all of its memory to a file on disk usually named ``core'`. If your program is called ``foo'` then your system may dump core as ``foo.core'`. If you are not getting a ``core'` file, make sure that your program has not changed to a new directory meaning that it may have written the core file in a different location. Also insure that your program has write privileges over the directory that it is in otherwise it will not be able to dump a core file. Core dumps are often security problems since they contain all program memory so systems often block their being produced. You will want to check your user and system's core dump size `ulimit` settings.

The library by default uses the ``abort'` function to dump core which may or may not work depending on your operating system. If the following program does not dump core then this may be the problem. See ``KILL_PROCESS'` definition in ``settings.dist'`.

```
main()
{
    abort();
}
```

If ``abort'` does work then you may want to try the following setting in ``settings.dist'`. This code tries to generate a segmentation fault by dereferencing a ``NULL'` pointer.

```
#define KILL_PROCESS    { int *_int_p = 0L; *_int_p = 1; }
```

## NULL in C/C++

NULL in C/C++ is just a macro which is often defined like this:

```
#define NULL ((void*)0)
```

( [libio.h](#) file )

`void*` is a data type reflecting the fact it's the pointer, but to a value of unknown data type (`void`).

<sup>38</sup><http://dmalloc.com/>

NULL is usually used to show absence of an object. For example, you have a single-linked list, and each node has a value (or pointer to a value) and *next* pointer. To show that there are no next node, 0 is stored to *next* field. (Other solutions are just worse.) Perhaps, you may have some crazy environment where you need to allocate memory blocks at zero address. How would you indicate absence of the next node? Some kind of *magic number*? Maybe -1? Or maybe using additional bit?

In Wikipedia we may find this:

In fact, quite contrary to the zero page's original preferential use, some modern operating systems such as FreeBSD, Linux and Microsoft Windows[2] actually make the zero page inaccessible to trap uses of NULL pointers.

( [https://en.wikipedia.org/wiki/Zero\\_page](https://en.wikipedia.org/wiki/Zero_page) )

## Null pointer to function

It's possible to call function by its address. For example, I compile this by MSVC 2010 and run it in Windows 7:

```
#include <windows.h>
#include <stdio.h>

int main()
{
    printf ("0x%x\n", &MessageBoxA);
};
```

The result is `0x7578feae` and doesn't changing after several times I run it, because `user32.dll` (where `MessageBoxA` function resides) is always loads at the same address. And also because [ASLR<sup>39</sup>](#) is not enabled (result would be different each time in that case).

Let's call `MessageBoxA()` by address:

```
#include <windows.h>
#include <stdio.h>

typedef int (*msgboxtype)(HWND hWnd, LPCTSTR lpText, LPCTSTR lpCaption,  UINT uType);

int main()
{
    msgboxtype msgboxaddr=0x7578feae;

    // force to load DLL into process memory,
    // since our code doesn't use any function from user32.dll,
    // and DLL is not imported
    LoadLibrary ("user32.dll");

    msgboxaddr(NULL, "Hello, world!", "hello", MB_OK);
};
```

Weird, but works in Windows 7 x86.

This is commonly used in shellcodes, because it's hard to call DLL functions by name from there. And [ASLR](#) is a countermeasure.

Now what is really weird, some embedded C programmers may be familiar with a code like that:

```
int reset()
{
    void (*foo)(void) = 0;
    foo();
};
```

<sup>39</sup>Address Space Layout Randomization

Who will want to call a function at address 0? This is portable way to jump at zero address. Many low-cost cheap microcontrollers also have no memory protection or [MMU](#) and after reset, they start to execute code at address 0, where some kind of initialization code is stored. So jumping to address 0 is a way to reset itself. One could use inline assembly, but if it's not possible, this portable method can be used.

It even compiles correctly by my GCC 4.8.4 on Linux x64:

```
reset:
    sub    rsp, 8
    xor    eax, eax
    call   rax
    add    rsp, 8
    ret
```

The fact that stack pointer is shifted is not a problem: initialization code in microcontrollers usually completely ignores registers and [RAM](#) state and boots from scratch.

And of course, this code will crash on \*NIX or Windows because of memory protection and even in absence of protection, there are no code at address 0.

GCC even has non-standard extension, allowing to jump to a specific address rather than call a function there: <http://gcc.gnu.org/onlinedocs/gcc/Labels-as-Values.html>.

### 3.23.5 Array as function argument

Someone may ask, what is the difference between declaring function argument type as array and as pointer?

As it seems, there are no difference at all:

```
void write_something1(int a[16])
{
    a[5]=0;
};

void write_something2(int *a)
{
    a[5]=0;
};

int f()
{
    int a[16];
    write_something1(a);
    write_something2(a);
};
```

Optimizing GCC 4.8.4:

```
write_something1:
    mov    DWORD PTR [rdi+20], 0
    ret

write_something2:
    mov    DWORD PTR [rdi+20], 0
    ret
```

But you may still declare array instead of pointer for self-documenting purposes, if the size of array is always fixed. And maybe, some static analysis tool will be able to warn you about possible buffer overflow. Or is it possible with some tools today?

Some people, including Linus Torvalds, criticizes this C/C++ feature: <https://lkml.org/lkml/2015/9/3/428>.

C99 standard also have *static* keyword [*ISO/IEC 9899:TC3 (C C99 standard)*, (2007) 6.7.5.3]:

If the keyword `static` also appears within the `[ and ]` of the array type derivation, then for each call to the function, the value of the corresponding actual argument shall provide access to the first element of an array with at least as many elements as specified by the size expression.

### 3.23.6 Pointer to a function

A function name in C/C++ without brackets, like `printf` is a pointer to function of `void (*)()` type. Let's try to read function's contents and patch it:

```
#include <memory.h>
#include <stdio.h>

void print_something ()
{
    printf ("we are in %s()\n", __FUNCTION__);
};

int main()
{
    print_something();
    printf ("first 3 bytes: %x %x %x...\n",
           *(unsigned char*)print_something,
           *((unsigned char*)print_something+1),
           *((unsigned char*)print_something+2));

    *(unsigned char*)print_something=0xC3; // RET's opcode
    printf ("going to call patched print_something():\n");
    print_something();
    printf ("it must exit at this point\n");
};
```

It tells, that the first 3 bytes of functions are `55 89 e5`. Indeed, these are opcodes of `PUSH EBP` and `MOV EBP, ESP` instructions (these are x86 opcodes). But then our program crashes, because `text` section is `readonly`.

We can recompile our example and make `text` section writable <sup>40</sup>:

```
gcc --static -g -Wl,--omagic -o example example.c
```

That works!

```
we are in print_something()
first 3 bytes: 55 89 e5...
going to call patched print_something():
it must exit at this point
```

### 3.23.7 Pointer to a function: copy protection

A software cracker can find a function that checks protection and return `true` or `false`. He/she then can put `XOR EAX,EAX / RETN` or `MOV EAX, 1 / RETN` there.

Can you check integrity of the function? As it turns out, this can be done easily.

According to `objdump`, the first 3 bytes of `check_protection()` are `0x55 0x89 0xE5` (given the fact this is non-optimizing GCC):

```
#include <stdlib.h>
#include <stdio.h>
```

<sup>40</sup><http://stackoverflow.com/questions/27581279/make-text-segment-writable-elf>



```

int check_protection()
{
    // do something
    return 0;
    // or return 1;
};

int main()
{
    if (check_protection()==0)
    {
        printf ("no protection installed\n");
        exit(0);
    };

    // ...and then, at some very important point...
    if (*((unsigned char*)check_protection)+0) != 0x55)
    {
        printf ("1st byte has been altered\n");
        // do something mean, add watermark, etc
    };
    if (*((unsigned char*)check_protection)+1) != 0x89)
    {
        printf ("2nd byte has been altered\n");
        // do something mean, add watermark, etc
    };
    if (*((unsigned char*)check_protection)+2) != 0xe5)
    {
        printf ("3rd byte has been altered\n");
        // do something mean, add watermark, etc
    };
};

```

```

0000054d <check_protection>:
54d: 55          push  %ebp
54e: 89 e5      mov   %esp,%ebp
550: e8 b7 00 00 00    call 60c <__x86.get_pc_thunk.ax>
555: 05 7f 1a 00 00    add  $0x1a7f,%eax
55a: b8 00 00 00 00    mov  $0x0,%eax
55f: 5d        pop  %ebp
560: c3        ret

```

If someone would patch the beginning of the `check_protection()` function, your program can do something mean, maybe exit suddenly. To find such a trick, a cracker can set a memory read breakpoint on the address of the function's beginning. ([tracer](#) has BPMx options for that.)

### 3.23.8 Pointer to a function: a common bug (or typo)

A notorious bug/typo:

```

int expired()
{
    // check license key, current date/time, etc
};

int main()
{
    if (expired) // must be expired() here
    {
        print ("expired\n");
        exit(0);
    }
    else
    {
        // do something
    };
};

```

Since the function's name alone is interpreted as a pointer to function, or address, the `if(function_name)` statement is like `if(true)`.

Unfortunately, a C/C++ compiler wouldn't issue a warning.

### 3.23.9 Pointer as object identifier

Both assembly language and C has no OOP features, but it's possible to write a code in OOP style (just treat structure as an object).

It's interesting, that sometimes, pointer to an object (or its address) is called as ID (in sense of data hiding/encapsulation).

For example, `LoadLibrary()`, according to MSDN<sup>41</sup>, returns "handle to the module"<sup>42</sup>. Then you pass this "handle" to other functions like `GetProcAddress()`. But in fact, `LoadLibrary()` returns pointer to DLL file mapped into memory<sup>43</sup>. You can read two bytes from the address `LoadLibrary()` returns, and that would be "MZ" (first two bytes of any .EXE/.DLL file in Windows).

Apparently, Microsoft "hides" that fact to provide better forward compatibility. Also, `HMODULE` and `HINSTANCE` data types had another meaning in 16-bit Windows.

Probably, this is reason why `printf()` has "%p" modifier, which is used for printing pointers (32-bit integers on 32-bit architectures, 64-bit on 64-bit, etc) in hexadecimal form. Address of a structure dumped into debug log may help in finding it in another place of log.

Here is also from SQLite source code:

```
...
struct Pager {
    sqlite3_vfs *pVfs;          /* OS functions to use for IO */
    u8 exclusiveMode;         /* Boolean. True if locking_mode==EXCLUSIVE */
    u8 journalMode;          /* One of the PAGER_JOURNALMODE_* values */
    u8 useJournal;           /* Use a rollback journal on this file */
    u8 noSync;               /* Do not sync the journal if true */
...
static int pagerLockDb(Pager *pPager, int eLock){
    int rc = SQLITE_OK;

    assert( eLock==SHARED_LOCK || eLock==RESERVED_LOCK || eLock==EXCLUSIVE_LOCK );
    if( pPager->eLock<eLock || pPager->eLock==UNKNOWN_LOCK ){
        rc = sqlite3OsLock(pPager->fd, eLock);
        if( rc==SQLITE_OK && (pPager->eLock!=UNKNOWN_LOCK||eLock==EXCLUSIVE_LOCK) ){
            pPager->eLock = (u8)eLock;
            IOTRACE(("LOCK %p %d\n", pPager, eLock))
        }
    }
    return rc;
}
...

PAGER_INCR(sqlite3_pager_readdb_count);
PAGER_INCR(pPager->nRead);
IOTRACE(("PGIN %p %d\n", pPager, pgno));
PAGERTRACE(("FETCH %d page %d hash(%08x)\n",
            PAGERID(pPager), pgno, pager_pagehash(pPg)));
...

```

<sup>41</sup>Microsoft Developer Network

<sup>42</sup>[https://msdn.microsoft.com/ru-ru/library/windows/desktop/ms684175\(v=vs.85\).aspx](https://msdn.microsoft.com/ru-ru/library/windows/desktop/ms684175(v=vs.85).aspx)

<sup>43</sup><https://blogs.msdn.microsoft.com/oldnewthing/20041025-00/?p=37483>

### 3.23.10 Oracle RDBMS and a simple garbage collector for C/C++

There was a time, when the author of these lines tried to learn more about Oracle RDBMS, searching for vulnerabilities, etc. This is a huge piece of software, and a typical function can take very large nested objects as arguments. And I wanted to dump these objects, as trees (or graphs).

Also, I tracked all memory allocations/deallocations by intercepting memory allocating/deallocating functions. And when a function to be intercepted getting a pointer to a block in memory, I search for the block in a list of blocks allocated. I'm getting its size + short name of block (this is like "tagging" in Windows OS kernel<sup>44</sup>).

Given a block, I can scan it for 32-bit words (on 32-bit OS) or for 64-bit words (on 64-bit OS). Each word can be a pointer to another block. And if it is so (I find this another block in my records), I can process it recursively.

And then, using GraphViz, I could render such a diagrams:

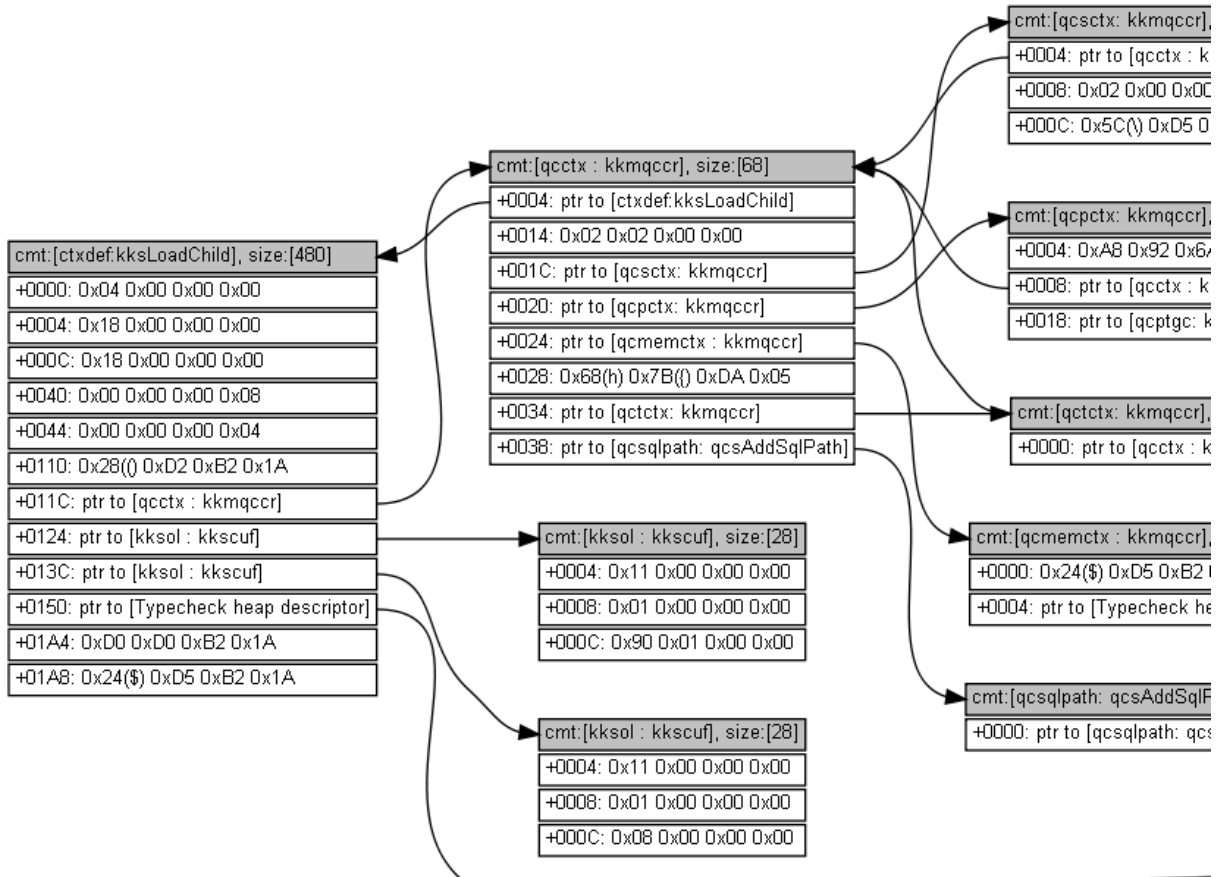

Bigger pictures: [1](#), [2](#).

This is quite impressive, given the fact that I had no information about data types of all these structures. But I could get some information from it.

### Now the garbage collector for C/C++: Boehm GC

If you use a block allocated in memory, its address has to be present somewhere, as a pointer in some structure/array in another allocated block, or in globally allocated structure, or in local variable in stack. If there are no pointer to a block, you can call it "orphan", and it will be a reason of memory leak.

And this is what GC<sup>45</sup> does. It scans all blocks (because it keep tabs on all blocks allocated) for pointers. It's important to understand, that it has no idea of data types of all these structure fields in blocks—this is important, GC has no information about types. It just scans blocks for 32-bit or 64-bit words and see, if they could be a pointers to another block(s). It also scans stack. It treats allocated blocks and stack as arrays of words, some of which may be pointers. And if it found a block allocated, which is "orphaned",

<sup>44</sup>Read more about comments in allocated blocks: Dennis Yurichev, *C/C++ programming language notes* <http://yurichev.com/C-book.html>

<sup>45</sup>Garbage Collector

i.e., there are no pointer(s) to it from another block(s) or stack, this block considered unneeded, to be freed. Scanning process takes time, and this is what for GCs are criticized.

Also, GC like Boehm GC<sup>46</sup> (for pure C) has function like `GC_malloc_atomic()`—using it, you declare that the block allocated using this function will never contain any pointer(s) to other block(s). Maybe this could be a text string, or other type of data. (Indeed, `GC_strdup()` calls `GC_malloc_atomic()`.) GC will not scan it.

## 3.24 Loop optimizations

### 3.24.1 Weird loop optimization

This is a simplest ever `memcpy()` function implementation:

```
void memcpy (unsigned char* dst, unsigned char* src, size_t cnt)
{
    size_t i;
    for (i=0; i<cnt; i++)
        dst[i]=src[i];
};
```

At least MSVC 6.0 from the end of 1990s till MSVC 2013 can produce a really weird code (this listing is generated by MSVC 2013 x86):

```
_dst$ = 8           ; size = 4
_src$ = 12          ; size = 4
_cnt$ = 16          ; size = 4
_memcpy PROC
    mov     edx, DWORD PTR _cnt$[esp-4]
    test   edx, edx
    je     SHORT $LN1@f
    mov     eax, DWORD PTR _dst$[esp-4]
    push   esi
    mov     esi, DWORD PTR _src$[esp]
    sub    esi, eax
; ESI=src-dst, i.e., pointers difference
$LL8@f:
    mov     cl, BYTE PTR [esi+eax] ; load byte at "esi+dst" or at "src-dst+dst" at the
beginning or at just "src"
    lea    eax, DWORD PTR [eax+1] ; dst++
    mov    BYTE PTR [eax-1], cl ; store the byte at "(dst++)--" or at just "dst" at the
beginning
    dec    edx ; decrement counter until we finished
    jne    SHORT $LL8@f
    pop    esi
$LN1@f:
    ret    0
_memcpy ENDP
```

This is weird, because how humans work with two pointers? They store two addresses in two registers or two memory cells. MSVC compiler in this case stores two pointers as one pointer (*sliding dst* in EAX) and difference between *src* and *dst* pointers (left unchanged over the span of loop body execution in ESI). (By the way, this is a rare case when `ptrdiff_t` data type can be used.) When it needs to load a byte from *src*, it loads it at *diff + sliding dst* and stores byte at just *sliding dst*.

This has to be some optimization trick. But I've rewritten this function to:

```
_f2 PROC
    mov     edx, DWORD PTR _cnt$[esp-4]
    test   edx, edx
    je     SHORT $LN1@f
    mov     eax, DWORD PTR _dst$[esp-4]
    push   esi
    mov     esi, DWORD PTR _src$[esp]
; eax=dst; esi=src
$LL8@f:
```

<sup>46</sup><https://www.hboehm.info/gc/>

```

        mov     cl, BYTE PTR [esi+edx]
        mov     BYTE PTR [eax+edx], cl
        dec     edx
        jne     SHORT $LL8@f
        pop     esi
$LN1@f:
        ret     0
_f2     ENDP

```

...and it works as efficient as the *optimized* version on my Intel Xeon E31220 @ 3.10GHz. Maybe, this optimization was targeted some older x86 CPUs of 1990s era, since this trick is used at least by ancient MS VC 6.0?

Any idea?

Hex-Rays 2.2 have a hard time recognizing patterns like that (hopefully, temporary?):

```

void __cdecl f1(char *dst, char *src, size_t size)
{
    size_t counter; // edx@1
    char *sliding_dst; // eax@2
    char tmp; // cl@3

    counter = size;
    if ( size )
    {
        sliding_dst = dst;
        do
        {
            tmp = (sliding_dst++)[src - dst]; // difference (src-dst) is calculated once, at
the beginning
            *(sliding_dst - 1) = tmp;
            --counter;
        }
        while ( counter );
    }
}

```

Nevertheless, this optimization trick is often used by MSVC (not just in [DIY<sup>47</sup>](#) homebrew *memcpy()* routines, but in many loops which uses two or more arrays), so it's worth for reverse engineers to keep it in mind.

### 3.24.2 Another loop optimization

If you process all elements of some array which happens to be located in global memory, compiler can optimize it. For example, let's calculate a sum of all elements of array of 128 *int*'s:

```

#include <stdio.h>

int a[128];

int sum_of_a()
{
    int rt=0;

    for (int i=0; i<128; i++)
        rt=rt+a[i];

    return rt;
};

int main()
{
    // initialize
    for (int i=0; i<128; i++)
        a[i]=i;
}

```

<sup>47</sup>Do It Yourself

```

// calculate the sum
printf ("%d\n", sum_of_a());
};

```

Optimizing GCC 5.3.1 (x86) can produce this (IDA):

```

.text:080484B0 sum_of_a      proc near
.text:080484B0             mov     edx, offset a
.text:080484B5             xor     eax, eax
.text:080484B7             mov     esi, esi
.text:080484B9             lea    edi, [edi+0]
.text:080484C0
.text:080484C0 loc_80484C0:           ; CODE XREF: sum_of_a+1B
.text:080484C0             add     eax, [edx]
.text:080484C2             add     edx, 4
.text:080484C5             cmp     edx, offset __libc_start_main@@GLIBC_2_0
.text:080484CB             jnz    short loc_80484C0
.text:080484CD             rep    retn
.text:080484CD sum_of_a      endp
.text:080484CD

...

.bss:0804A040             public a
.bss:0804A040 a             dd 80h dup(?) ; DATA XREF: main:loc_8048338
.bss:0804A040                                     ; main+19
.bss:0804A040 _bss         ends
.bss:0804A040

extern:0804A240 ; =====
extern:0804A240
extern:0804A240 ; Segment type: Externs
extern:0804A240 ; extern
extern:0804A240             extrn __libc_start_main@@GLIBC_2_0:near
extern:0804A240                                     ; DATA XREF: main+25
extern:0804A240                                     ; main+5D
extern:0804A244             extrn __printf_chk@@GLIBC_2_3_4:near
extern:0804A248             extrn __libc_start_main:near
extern:0804A248                                     ; CODE XREF: __libc_start_main
extern:0804A248                                     ; DATA XREF: .got.plt:off_804A00C

```

What the heck is `__libc_start_main@@GLIBC_2_0` at `0x080484C5`? This is a label just after end of `a[]` array. The function can be rewritten like this:

```

int sum_of_a_v2()
{
    int *tmp=a;
    int rt=0;

    do
    {
        rt=rt+(*tmp);
        tmp++;
    }
    while (tmp<(a+128));

    return rt;
};

```

First version has *i* counter, and the address of each element of array is to be calculated at each iteration. The second version is more optimized: the pointer to each element of array is always ready and is sliding 4 bytes forward at each iteration. How to check if the loop is ended? Just compare the pointer with the address just behind array's end, which is, in our case, is happens to be address of imported `__libc_start_main()` function from Glibc 2.0. Sometimes code like this is confusing, and this is very popular optimizing trick, so that's why I made this example.

My second version is very close to what GCC did, and when I compile it, the code is almost the same as in first version, but two first instructions are swapped:

```

.text:080484D0      public sum_of_a_v2
.text:080484D0 sum_of_a_v2      proc near
.text:080484D0      xor     eax, eax
.text:080484D2      mov     edx, offset a
.text:080484D7      mov     esi, esi
.text:080484D9      lea    edi, [edi+0]
.text:080484E0
.text:080484E0 loc_80484E0:      ; CODE XREF: sum_of_a_v2+1B
.text:080484E0      add     eax, [edx]
.text:080484E2      add     edx, 4
.text:080484E5      cmp     edx, offset __libc_start_main@@GLIBC_2_0
.text:080484EB      jnz    short loc_80484E0
.text:080484ED      rep    retn
.text:080484ED sum_of_a_v2      endp

```

Needless to say, this optimization is possible if the compiler can calculate address of the end of array during compilation time. This happens if the array is global and it's size is fixed.

However, if the address of array is unknown during compilation, but size is fixed, address of the label just behind array's end can be calculated at the beginning of the loop.

## 3.25 More about structures

### 3.25.1 Sometimes a C structure can be used instead of array

#### Arithmetic mean

```

#include <stdio.h>

int mean(int *a, int len)
{
    int sum=0;
    for (int i=0; i<len; i++)
        sum=sum+a[i];
    return sum/len;
};

struct five_ints
{
    int a0;
    int a1;
    int a2;
    int a3;
    int a4;
};

int main()
{
    struct five_ints a;
    a.a0=123;
    a.a1=456;
    a.a2=789;
    a.a3=10;
    a.a4=100;
    printf ("%d\n", mean(&a, 5));
    // test: https://www.wolframalpha.com/input/?i=mean(123,456,789,10,100)
};

```

This works: *mean()* function will never access behind the end of *five\_ints* structure, because 5 is passed, meaning, only 5 integers will be accessed.

#### Putting string into structure

```

#include <stdio.h>

```

```

struct five_chars
{
    char a0;
    char a1;
    char a2;
    char a3;
    char a4;
} __attribute__((aligned (1),packed));

int main()
{
    struct five_chars a;
    a.a0='h';
    a.a1='i';
    a.a2='!';
    a.a3='\n';
    a.a4=0;
    printf (&a); // prints "hi!"
};

```

((aligned (1),packed)) attribute must be used, because otherwise, each structure field will be aligned on 4-byte or 8-byte boundary.

## Summary

This is just another example of how structures and arrays are stored in memory. Perhaps, no sane programmer will do something like in this example, except in case of some specific hack. Or maybe in case of source code obfuscation?

### 3.25.2 Unsized array in C structure

In some win32 structures we can find ones with last field defined as an array of one element:

```

typedef struct _SYMBOL_INFO {
    ULONG    SizeOfStruct;
    ULONG    TypeIndex;

    ...

    ULONG    MaxNameLen;
    TCHAR    Name[1];
} SYMBOL_INFO, *PSYMBOL_INFO;

```

( [https://msdn.microsoft.com/en-us/library/windows/desktop/ms680686\(v=vs.85\).aspx](https://msdn.microsoft.com/en-us/library/windows/desktop/ms680686(v=vs.85).aspx) )

This is a hack, meaning, the last field is array of unknown size, which is to be calculated at the time of structure allocation.

Why: *Name* field may be short, so why to define it with some kind of *MAX\_NAME* constant which can be 128, 256, or even bigger?

Why not to use pointer instead? Then you have to allocate two blocks: one for structure and the other one for string. This may be slower and may require larger memory overhead. Also, you need dereference pointer (i.e., read address of the string from the structure)—not a big deal, but some people say this is still surplus cost.

This is also known as *struct hack*: <http://c-faq.com/struct/structhack.html>.

Example:

```

#include <stdio.h>

struct st
{
    int a;
    int b;

```



```

    char s[];
};

void f (struct st *s)
{
    printf ("%d %d %s\n", s->a, s->b, s->s);
    // f() can't replace s[] with bigger string - size of allocated block is unknown at this
    point
};

int main()
{
#define STRING "Hello!"
    struct st *s=malloc(sizeof(struct st)+strlen(STRING)+1); // incl. terminating zero
    s->a=1;
    s->b=2;
    strcpy (s->s, STRING);
    f(s);
};

```

In short, it works because C has no array boundary checks. Any array is treated as having infinite size.

Problem: after allocation, the whole size of allocated block for structure is unknown (except for memory manager), so you can't just replace string with larger string. You would still be able to do so if the field would be declared as something like `s[MAX_NAME]`.

In other words, you have a structure plus an array (or string) fused together in the single allocated memory block. Another problem is what you obviously can't declare two such arrays in single structure, or to declare another field after such array.

Older compilers require to declare array with at least one element: `s[1]`, newer allows to declare it as variable-sized array: `s[]`. This is also called *flexible array member* in C99 standard.

Read more about it in GCC documentation<sup>48</sup>, MSDN documentation<sup>49</sup>.

Dennis Ritchie (one of C creators) called this trick “unwarranted chumminess with the C implementation” (perhaps, acknowledging hackish nature of the trick).

Like it or not, use it or not: it is still another demonstration on how structures are stored in memory, that's why I write about it.

### 3.25.3 Version of C structure

Many Windows programmers have seen this in MSDN:

```

SizeOfStruct
    The size of the structure, in bytes. This member must be set to sizeof(SYMBOL_INFO).

```

( [https://msdn.microsoft.com/en-us/library/windows/desktop/ms680686\(v=vs.85\).aspx](https://msdn.microsoft.com/en-us/library/windows/desktop/ms680686(v=vs.85).aspx) )

Some structures like `SYMBOL_INFO` has started with this field indeed. Why? This is some kind of structure version.

Imagine you have a function which draws circle. It takes a single argument—a pointer to a structure with only three fields: X, Y and radius. And then color displays flooded a market, sometimes in 1980s. And you want to add `color` argument to the function. But, let's say, you cannot add another argument to it (a lot of software use your `API`<sup>50</sup> and cannot be recompiled). And if the old piece of software uses your `API` with color display, let your function draw a circle in (default) black and white colors.

Another day you add another feature: circle now can be filled, and brush type can be set.

Here is one solution to the problem:

```

#include <stdio.h>

struct ver1
{

```

<sup>48</sup><https://gcc.gnu.org/onlinedocs/gcc/Zero-Length.html>

<sup>49</sup><https://msdn.microsoft.com/en-us/library/b6fae073.aspx>

<sup>50</sup>Application Programming Interface

```

    size_t SizeOfStruct;
    int coord_X;
    int coord_Y;
    int radius;
};

struct ver2
{
    size_t SizeOfStruct;
    int coord_X;
    int coord_Y;
    int radius;
    int color;
};

struct ver3
{
    size_t SizeOfStruct;
    int coord_X;
    int coord_Y;
    int radius;
    int color;
    int fill_brush_type; // 0 - do not fill circle
};

void draw_circle(struct ver3 *s) // latest struct version is used here
{
    // we presume SizeOfStruct, coord_X and coord_Y fields are always present
    printf ("We are going to draw a circle at %d:%d\n", s->coord_X, s->coord_Y);

    if (s->SizeOfStruct>=sizeof(int)*5)
    {
        // this is at least ver2, color field is present
        printf ("We are going to set color %d\n", s->color);
    }

    if (s->SizeOfStruct>=sizeof(int)*6)
    {
        // this is at least ver3, fill_brush_type field is present
        printf ("We are going to fill it using brush type %d\n", s->fill_brush_type);
    }
};

// early software version
void call_as_ver1()
{
    struct ver1 s;
    s.SizeOfStruct=sizeof(s);
    s.coord_X=123;
    s.coord_Y=456;
    s.radius=10;
    printf ("** %s()\n", __FUNCTION__);
    draw_circle(&s);
};

// next software version
void call_as_ver2()
{
    struct ver2 s;
    s.SizeOfStruct=sizeof(s);
    s.coord_X=123;
    s.coord_Y=456;
    s.radius=10;
    s.color=1;
    printf ("** %s()\n", __FUNCTION__);
    draw_circle(&s);
};

// latest, the most extended version
void call_as_ver3()

```

```

{
    struct ver3 s;
    s.SizeOfStruct=sizeof(s);
    s.coord_X=123;
    s.coord_Y=456;
    s.radius=10;
    s.color=1;
    s.fill_brush_type=3;
    printf ("** %s()\n", __FUNCTION__);
    draw_circle(&s);
};

int main()
{
    call_as_ver1();
    call_as_ver2();
    call_as_ver3();
};

```

In other words, *SizeOfStruct* field takes a role of *version of structure* field. It could be enumerate type (1, 2, 3, etc.), but to set *SizeOfStruct* field to *sizeof(struct...)* is less prone to mistakes/bugs: we just write *s.SizeOfStruct=sizeof(...)* in caller's code.

In C++, this problem is solved using *inheritance* ( 3.21.1 on page 552). You just extend your base class (let's call it *Circle*), and then you will have *ColoredCircle* and then *FilledColoredCircle*, and so on. A current *version* of an object (or, more precisely, current *type*) will be determined using C++ [RTTI](#).

So when you see *SizeOfStruct* somewhere in [MSDN](#)—perhaps this structure was extended at least once in past.

### 3.25.4 High-score file in “Block out” game and primitive serialization

Many videogames has high-score file, sometimes called “Hall of fame”. Ancient “Block out”<sup>51</sup> game (3D tetris from 1989) isn't exception, here is what we see at the end:

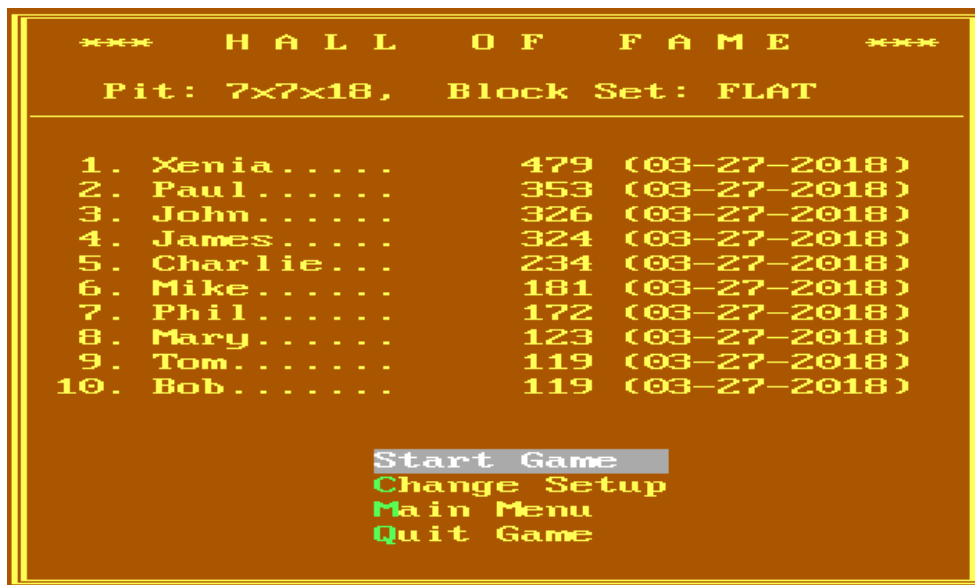

Figure 3.4: High score table

Now we can see that the file has changed after we added our name is *BLSCORE.DAT*.

```

% xxd -g 1 BLSCORE.DAT

00000000: 0a 00 58 65 6e 69 61 2e 2e 2e 2e 00 df 01 00  ..Xenia.....
00000010: 00 30 33 2d 32 37 2d 32 30 31 38 00 50 61 75 6c  .03-27-2018.Paul
00000020: 2e 2e 2e 2e 2e 2e 00 61 01 00 00 30 33 2d 32 37  .....a...03-27
00000030: 2d 32 30 31 38 00 4a 6f 68 6e 2e 2e 2e 2e 2e 2e  -2018.John.....

```

<sup>51</sup><http://www.bestoldgames.net/eng/old-games/blockout.php>

```

00000040: 00 46 01 00 00 30 33 2d 32 37 2d 32 30 31 38 00 .F...03-27-2018.
00000050: 4a 61 6d 65 73 2e 2e 2e 2e 2e 00 44 01 00 00 30 James.....D...0
00000060: 33 2d 32 37 2d 32 30 31 38 00 43 68 61 72 6c 69 3-27-2018.Charli
00000070: 65 2e 2e 2e 00 ea 00 00 00 30 33 2d 32 37 2d 32 e.....03-27-2
00000080: 30 31 38 00 4d 69 6b 65 2e 2e 2e 2e 2e 2e 00 b5 018.Mike.....
00000090: 00 00 00 30 33 2d 32 37 2d 32 30 31 38 00 50 68 ...03-27-2018.Ph
000000a0: 69 6c 2e 2e 2e 2e 2e 2e 00 ac 00 00 00 30 33 2d il.....03-
000000b0: 32 37 2d 32 30 31 38 00 4d 61 72 79 2e 2e 2e 2e 27-2018.Mary....
000000c0: 2e 2e 00 7b 00 00 00 30 33 2d 32 37 2d 32 30 31 ...{...03-27-201
000000d0: 38 00 54 6f 6d 2e 2e 2e 2e 2e 2e 00 77 00 00 8.Tom.....w..
000000e0: 00 30 33 2d 32 37 2d 32 30 31 38 00 42 6f 62 2e .03-27-2018.Bob.
000000f0: 2e 2e 2e 2e 2e 2e 00 77 00 00 30 33 2d 32 37 .....w...03-27
00000100: 2d 32 30 31 38 00 -2018.

```

All entries are clearly visible. The very first byte is probably number of entries. Second is zero and, in fact, number of entries can be 16-bit value spanning over first two bytes.

Next, after “Xenia” name we see 0xDF and 0x01 bytes. Xenia has score of 479, and this is exactly 0x1DF in hexadecimal radix. So a high score value is probably 16-bit integer, or maybe 32-bit integer: there are two more zero bytes after.

Now let’s think about the fact that both array elements and structure elements are always placed in memory adjacently to each other. That enables us to write the whole array/structure to the file using simple *write()* or *fwrite()* function, and then restore it using *read()* or *fread()*, as simple as that. This is what is called *serialization* nowadays.

## Read

Now let’s write C program to read highscore file:

```

#include <assert.h>
#include <stdio.h>
#include <stdint.h>
#include <string.h>

struct entry
{
    char name[11]; // incl. terminating zero
    uint32_t score;
    char date[11]; // incl. terminating zero
} __attribute__((aligned (1),packed));

struct highscore_file
{
    uint8_t count;
    uint8_t unknown;
    struct entry entries[10];
} __attribute__((aligned (1), packed));

struct highscore_file file;

int main(int argc, char* argv[])
{
    FILE* f=fopen(argv[1], "rb");
    assert (f!=NULL);
    size_t got=fread(&file, 1, sizeof(struct highscore_file), f);
    assert (got==sizeof(struct highscore_file));
    fclose(f);
    for (int i=0; i<file.count; i++)
    {
        printf ("name=%s score=%d date=%s\n",
                file.entries[i].name,
                file.entries[i].score,
                file.entries[i].date);
    };
};

```

We need GCC (*aligned (1),packed*) attribute so that all structure fields will be packed on 1-byte boundary.

Of course it works:

```
name=Xenia..... score=479 date=03-27-2018
name=Paul..... score=353 date=03-27-2018
name=John..... score=326 date=03-27-2018
name=James..... score=324 date=03-27-2018
name=Charlie... score=234 date=03-27-2018
name=Mike..... score=181 date=03-27-2018
name=Phil..... score=172 date=03-27-2018
name=Mary..... score=123 date=03-27-2018
name=Tom..... score=119 date=03-27-2018
name=Bob..... score=119 date=03-27-2018
```

(Needless to say, each name is padded with dots, both on screen and in the file, perhaps, for æsthetical reasons.)

## Write

Let's check if we right about width of score value. Is it really has 32 bits?

```
int main(int argc, char* argv[])
{
    FILE* f=fopen(argv[1], "rb");
    assert (f!=NULL);
    size_t got=fread(&file, 1, sizeof(struct highscore_file), f);
    assert (got==sizeof(struct highscore_file));
    fclose(f);

    strcpy (file.entries[1].name, "Mallory...");
    file.entries[1].score=12345678;
    strcpy (file.entries[1].date, "08-12-2016");

    f=fopen(argv[1], "wb");
    assert (f!=NULL);
    got=fwrite(&file, 1, sizeof(struct highscore_file), f);
    assert (got==sizeof(struct highscore_file));
    fclose(f);
};
```

Let's run Blockout:

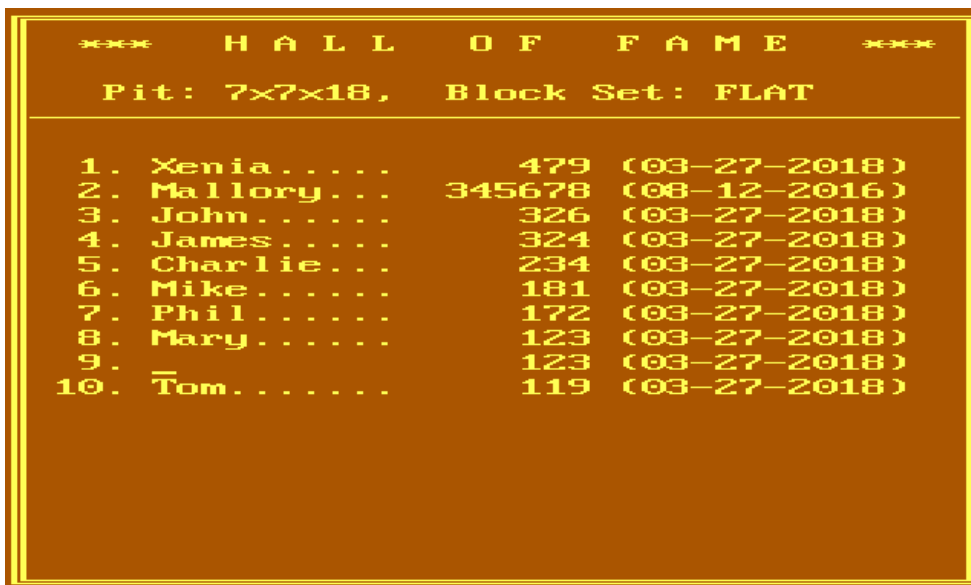

*** HALL OF FAME ***		
Pit: 7x7x18, Block Set: FLAT		
1.	Xenia.....	479 (03-27-2018)
2.	Mallory...	345678 (08-12-2016)
3.	John.....	326 (03-27-2018)
4.	James.....	324 (03-27-2018)
5.	Charlie...	234 (03-27-2018)
6.	Mike.....	181 (03-27-2018)
7.	Phil.....	172 (03-27-2018)
8.	Mary.....	123 (03-27-2018)
9.	Tom.....	123 (03-27-2018)
10.	Bob.....	119 (03-27-2018)

Figure 3.5: High score table

First two digits (1 and 2) are truncated: 12345678 becomes 345678. Perhaps, this is formatting issues... but the number is almost correct. Now I'm changing it to 999999 and run again:

```

*** H A L L O F F A M E ***
Pit: 7x7x18, Block Set: FLAT

1. Xenia..... 479 (03-27-2018)
2. Mallory... 999999 (08-12-2016)
3. John..... 326 (03-27-2018)
4. James..... 324 (03-27-2018)
5. Charlie... 234 (03-27-2018)
6. Mike..... 181 (03-27-2018)
7. Phil..... 172 (03-27-2018)
8. .... 133 (03-27-2018)
9. .... 132 (03-27-2018)
10. Mary..... 123 (03-27-2018)

```

Figure 3.6: High score table

Now it's correct. Yes, high score value is 32-bit integer.

### Is it serialization?

...almost. Serialization like this is highly popular in scientific and engineering software, where efficiency and speed is much more important than converting into [XML](#)<sup>52</sup> or [JSON](#)<sup>53</sup> and back.

One important thing is that you obviously cannot serialize pointers, because each time you load the file into memory, all the structures may be allocated in different places.

But: if you work on some kind of low-cost [MCU](#) with simple [OS](#) on it and you have your structures allocated at always same places in memory, perhaps you can save and restore pointers as well.

### Random noise

When I prepared this example, I had to run "Block out" many times and played for it a bit to fill high-score table with random names.

And when there were just 3 entries in the file, I saw this:

```

00000000: 03 00 54 6f 6d 61 73 2e 2e 2e 2e 2e 00 da 2a 00 ..Tomas.....*.
00000010: 00 30 38 2d 31 32 2d 32 30 31 36 00 43 68 61 72 .08-12-2016.Char
00000020: 6c 69 65 2e 2e 2e 00 8b 1e 00 00 30 38 2d 31 32 lie.....08-12
00000030: 2d 32 30 31 36 00 4a 6f 68 6e 2e 2e 2e 2e 2e -2016.John.....
00000040: 00 80 00 00 00 30 38 2d 31 32 2d 32 30 31 36 00 ....08-12-2016.
00000050: 00 00 57 c8 a2 01 06 01 ba f9 47 c7 05 00 f8 4f ..W.....G....0
00000060: 06 01 06 01 a6 32 00 00 00 00 00 00 00 00 00 .....2.....
00000070: 00 00 00 00 00 00 00 00 00 00 00 00 00 00 00 .....
00000080: 00 00 00 00 00 00 00 00 00 00 00 00 00 00 00 .....
00000090: 00 00 00 00 00 00 00 00 00 00 00 00 00 00 00 .....
000000a0: 00 00 00 00 00 00 00 00 00 00 93 c6 a2 01 46 72 .....Fr
000000b0: 8c f9 f6 c5 05 00 f8 4f 00 02 06 01 a6 32 06 01 .....0.....2..
000000c0: 00 00 98 f9 f2 c0 05 00 f8 4f 00 02 a6 32 a2 f9 .....0.....2..
000000d0: 80 c1 a6 32 a6 32 f4 4f aa f9 39 c1 a6 32 06 01 ...2.2.0..9..2..
000000e0: b4 f9 2b c5 a6 32 e1 4f c7 c8 a2 01 82 72 c6 f9 ..+..2.0.....r..
000000f0: 30 c0 05 00 00 00 00 00 00 00 a6 32 d4 f9 76 2d 0.....2..v-
00000100: a6 32 00 00 00 00 .....2....

```

The first byte has value of 3, meaning there are 3 entries. And there are 3 entries present. But then we see a random noise at the second half of file.

<sup>52</sup>Extensible Markup Language

<sup>53</sup>JavaScript Object Notation

The noise is probably has its origins in uninitialized data. Perhaps, “Block out” allocated memory for 10 entries somewhere in [heap](#), where, obviously, some pseudorandom noise (left from something else) was present. Then it set first/second byte, fill 3 entries, and then it never touched 7 entries left, so they are written to the file as is.

When “Block out” loads high score file at the next run, it reads number of entries from the first/second byte (3) and then completely ignores what is after it.

This is common problem. Not a problem in strict sense: it’s not a bug, but information can be exposed outwards.

Microsoft Word versions from 1990s has been often left pieces of previously edited texts into the \*.doc\* files. It was some kind of amusement back then, to get a .doc file from someone, then open it in a hexadecimal editor and read something else, what has been edited on that computer before.

The problem can be even much more serious: Heartbleed bug in OpenSSL.

## Homework

“Block out” has several polycubes (flat/basic/extended), size of pit can be configured, etc. And it seems, for each configuration, “Block out” has its own high score table. I’ve noticed that some information is probably stored in *BLSCORE.IDX* file. This can be a homework for hardcore “Block out” fans—to understand its structure as well.

The “Block out” files are here: <http://beginners.re/examples/blockout.zip> (including the binary high score files I’ve used in this example). You can use DosBox to run it.

## 3.26 memmove() and memcpy()

The difference between these standard functions is that *memcpy()* blindly copies a block to another place, while *memmove()* correctly handles overlapping blocks. For example, you want to tug a string two bytes forward:

```
`|.|.|h|e|l|l|o|...` -> `|h|e|l|l|o|...`
```

*memcpy()* which copies 32-bit or 64-bit words at once, or even [SIMD](#), will obviously fail here, a byte-wise copy routine must be used instead.

Now even more advanced example, insert two bytes in front of string:

```
`|h|e|l|l|o|...` -> `|.|.|h|e|l|l|o|...`
```

Now even byte-wise memory copy routine will fail, you have to copy bytes starting at the end.

That’s a rare case where DF x86 flag is to be set before REP MOVSB instruction: DF defines direction, and now we must move backwardly.

The typical *memmove()* routine works like this: 1) if source is below destination, copy forward; 2) if source is above destination, copy backward.

This is *memmove()* from uClibc:

```
void *memmove(void *dest, const void *src, size_t n)
{
    int eax, ecx, esi, edi;
    __asm__ __volatile__(
        "    movl    %%eax, %%edi\n"
        "    cmpl    %%esi, %%eax\n"
        "    je     2f\n" /* (optional) src == dest -> NOP */
        "    jb     1f\n" /* src > dest -> simple copy */
        "    leal   -1(%%esi,%%ecx), %%esi\n"
        "    leal   -1(%%eax,%%ecx), %%edi\n"
        "    std\n"
        "1:    rep; movsb\n"
        "    cld\n"
```

```

        "2:\n"
        : "&c" (ecx), "&S" (esi), "&a" (eax), "&D" (edi)
        : "0" (n), "1" (src), "2" (dest)
        : "memory"
    );
    return (void*)eax;
}

```

In the first case, REP MOVSB is called with DF flag cleared. In the second, DF is set, then cleared.

More complex algorithm has the following piece in it:

“if difference between *source* and *destination* is larger than width of **word**, copy using words rather than bytes, and use byte-wise copy to copy unaligned parts”.

This how it happens in Glibc 2.24 in non-optimized C part.

Given all that, *memmove()* may be slower than *memcpy()*. But some people, including Linus Torvalds, argue<sup>54</sup> that *memcpy()* should be an alias (or synonym) of *memmove()*, and the latter function must just check at start, if the buffers are overlapping or not, and then behave as *memcpy()* or *memmove()*. Nowadays, check for overlapping buffers is very cheap, after all.

### 3.26.1 Anti-debugging trick

I’ve heard about anti-debugging trick where all you need is just set DF to crash the process: the very next *memcpy()* routine will lead to crash because it copies backwardly. But I can’t check this: it seems all memory copy routines clear/set DF as they want to. On the other hand, *memmove()* from uClibc I cited here, has no explicit clear of DF (it assumes DF is always clear?), so it can really crash.

## 3.27 setjmp/longjmp

setjmp/longjmp is a mechanism in C which is very similar to throw/catch mechanism in C++ and other higher-level PLs. Here is an example from zlib:

```

...

/* return if bits() or decode() tries to read past available input */
if (setjmp(s.env) != 0) /* if came back here via longjmp(), */
    err = 2; /* then skip decomp(), return error */
else
    err = decomp(&s); /* decompress */

...

/* load at least need bits into val */
val = s->bitbuf;
while (s->bitcnt < need) {
    if (s->left == 0) {
        s->left = s->infun(s->inhow, &(s->in));
        if (s->left == 0) longjmp(s->env, 1); /* out of input */
    }
}

...

if (s->left == 0) {
    s->left = s->infun(s->inhow, &(s->in));
    if (s->left == 0) longjmp(s->env, 1); /* out of input */
}

```

(zlib/contrib/blast/blast.c)

Call to setjmp() saves current PC, SP and other registers into env structure, then it returns 0.

In case of error, longjmp() *teleporting* you into the point after right after setjmp() call, as if setjmp() call returned non-null value (which was passed to longjmp()). This reminds as fork() syscall in UNIX.

Now let’s take a look on distilled example:

<sup>54</sup>[https://bugzilla.redhat.com/show\\_bug.cgi?id=638477#c132](https://bugzilla.redhat.com/show_bug.cgi?id=638477#c132)



```

#include <stdio.h>
#include <setjmp.h>

jmp_buf env;

void f2()
{
    printf ("%s() begin\n", __FUNCTION__);
    // something odd happened here
    longjmp (env, 1234);
    printf ("%s() end\n", __FUNCTION__);
};

void f1()
{
    printf ("%s() begin\n", __FUNCTION__);
    f2();
    printf ("%s() end\n", __FUNCTION__);
};

int main()
{
    int err=setjmp(env);
    if (err==0)
    {
        f1();
    }
    else
    {
        printf ("Error %d\n", err);
    }
};

```

If we run it, we will see:

```

f1() begin
f2() begin
Error 1234

```

jmp\_buf structure usually comes undocumented, to preserve forward compatibility.

Let's see how setjmp() implemented in MSVC 2013 x64:

```

...
; RCX = address of jmp_buf

mov     [rcx], rax
mov     [rcx+8], rbx
mov     [rcx+18h], rbp
mov     [rcx+20h], rsi
mov     [rcx+28h], rdi
mov     [rcx+30h], r12
mov     [rcx+38h], r13
mov     [rcx+40h], r14
mov     [rcx+48h], r15
lea     r8, [rsp+arg_0]
mov     [rcx+10h], r8
mov     r8, [rsp+0]      ; get saved RA from stack
mov     [rcx+50h], r8    ; save it
stmxcsr dword ptr [rcx+58h]
fnstcw word ptr [rcx+5Ch]
movdqa xmmword ptr [rcx+60h], xmm6
movdqa xmmword ptr [rcx+70h], xmm7
movdqa xmmword ptr [rcx+80h], xmm8
movdqa xmmword ptr [rcx+90h], xmm9
movdqa xmmword ptr [rcx+0A0h], xmm10

```

```

movdqa xmmword ptr [rcx+0B0h], xmm11
movdqa xmmword ptr [rcx+0C0h], xmm12
movdqa xmmword ptr [rcx+0D0h], xmm13
movdqa xmmword ptr [rcx+0E0h], xmm14
movdqa xmmword ptr [rcx+0F0h], xmm15
retn

```

It just populates `jmp_buf` structure with current values of almost all registers. Also, current value of `RA` is taken from the stack and saved in `jmp_buf`: it will be used as new value of `PC` in future.

Now `longjmp()`:

```

...

; RCX = address of jmp_buf

mov     rax, rdx
mov     rbx, [rcx+8]
mov     rsi, [rcx+20h]
mov     rdi, [rcx+28h]
mov     r12, [rcx+30h]
mov     r13, [rcx+38h]
mov     r14, [rcx+40h]
mov     r15, [rcx+48h]
ldmxcsr dword ptr [rcx+58h]
fnclex
fldcw  word ptr [rcx+5Ch]
movdqa xmm6, xmmword ptr [rcx+60h]
movdqa xmm7, xmmword ptr [rcx+70h]
movdqa xmm8, xmmword ptr [rcx+80h]
movdqa xmm9, xmmword ptr [rcx+90h]
movdqa xmm10, xmmword ptr [rcx+0A0h]
movdqa xmm11, xmmword ptr [rcx+0B0h]
movdqa xmm12, xmmword ptr [rcx+0C0h]
movdqa xmm13, xmmword ptr [rcx+0D0h]
movdqa xmm14, xmmword ptr [rcx+0E0h]
movdqa xmm15, xmmword ptr [rcx+0F0h]
mov     rdx, [rcx+50h] ; get PC (RIP)
mov     rbp, [rcx+18h]
mov     rsp, [rcx+10h]
jmp     rdx           ; jump to saved PC

...

```

It just restores (almost) all registers, takes `RA` from structure and jumps there. This effectively works as if `setjmp()` returned to caller. Also, `RAX` is set to be equal to the second argument of `longjmp()`. This works as if `setjmp()` returned non-zero value at first place.

As a side effect of `SP` restoration, all values in stack which has been set and used between `setjmp()` and `longjmp()` calls are just dropped. They will not be used anymore. Hence, `longjmp()` usually jumps backwards<sup>55</sup>.

This implies that, unlike in throw/catch mechanism in C++, no memory will be freed, no destructors will be called, etc. Hence, this technique sometimes can be dangerous. Nevertheless, it's still quite popular. It's still used in Oracle RDBMS.

It also has unexpected side-effect: if some buffer has been overflowed inside of a function (maybe due to remote attack), and a function wants to report error, and it calls `longjmp()`, overwritten stack part just gets unused.

As an exercise, you can try to understand, why not all registers are saved. Why `XMM0-XMM5` and other registers are skipped?

<sup>55</sup>However, there are some people who can use it for much more complicated things, imitating coroutines, etc: <https://www.embeddedrelated.com/showarticle/455.php>, <http://fanf.livejournal.com/105413.html>

## 3.28 Other weird stack hacks

### 3.28.1 Accessing arguments/local variables of caller

From C/C++ basics we know that this is impossible for a function to access arguments of caller function or its local variables.

Nevertheless, it's possible using dirty hacks. For example:

```
#include <stdio.h>

void f(char *text)
{
    // print stack
    int *tmp=&text;
    for (int i=0; i<20; i++)
    {
        printf ("0x%x\n", *tmp);
        tmp++;
    };
};

void draw_text(int X, int Y, char* text)
{
    f(text);

    printf ("We are going to draw [%s] at %d:%d\n", text, X, Y);
};

int main()
{
    printf ("address of main()=0x%x\n", &main);
    printf ("address of draw_text()=0x%x\n", &draw_text);
    draw_text(100, 200, "Hello!");
};
```

On 32-bit Ubuntu 16.04 and GCC 5.4.0, I got this:

```
address of main()=0x80484f8
address of draw_text()=0x80484cb
0x8048645      first argument to f()
0x8048628
0xbfd8ab98
0xb7634590
0xb779eddc
0xb77e4918
0xbfd8aba8
0x8048547      return address into the middle of main()
0x64          first argument to draw_text()
0xc8          second argument to draw_text()
0x8048645      third argument to draw_text()
0x8048581
0xb779d3dc
0xbfd8abc0
0x0
0xb7603637
0xb779d000
0xb779d000
0x0
0xb7603637
```

(Comments are mine.)

Since *f()* starting to enumerate stack elements at its first argument, the first stack element is indeed a pointer to "Hello!" string. We see its address is also used as third argument to *draw\_text()* function.

In *f()* we could read all functions arguments and local variables if we know exact stack layout, but it's always changed, from compiler to compiler. Various optimization levels affect stack layout greatly.

But if we can somehow detect information we need, we can use it and even modify it. As an example, I'll rework `f()` function:

```
void f(char *text)
{
    ...

    // find 100, 200 values pair and modify the second on
    tmp=&text;
    for (int i=0; i<20; i++)
    {
        if (*tmp==100 && *(tmp+1)==200)
        {
            printf ("found\n");
            *(tmp+1)=210; // change 200 to 210
            break;
        };
        tmp++;
    };
};
```

Holy moly, it works:

```
found
We are going to draw [Hello!] at 100:210
```

## Summary

It's extremely dirty hack, intended to demonstrate stack internals. I never ever seen or heard that anyone used this in a real code. But still, this is a good example.

## Exercise

The example has been compiled without optimization on 32-bit Ubuntu using GCC 5.4.0 and it works. But when I turn on `-O3` maximum optimization, it's failed. Try to find why.

Use your favorite compiler and OS, try various optimization levels, find if it works and if it doesn't, find why.

### 3.28.2 Returning string

This is classic bug from Brian W. Kernighan, Rob Pike, *Practice of Programming*, (1999):

```
#include <stdio.h>

char* amsg(int n, char* s)
{
    char buf[100];

    sprintf (buf, "error %d: %s\n", n, s) ;

    return buf;
};

int main()
{
    printf ("%s\n", amsg (1234, "something wrong!"));
};
```

It would crash. First, let's understand, why.

This is a stack state before `amsg()` return:

```
(lower addresses)
...
[amsg(): 100 bytes]
[RA]                <- current SP
[two amsg arguments]
[something else]
[main() local variables]
...
(upper addresses)
```

When `amsg()` returns control flow to `main()`, so far so good. But `printf()` is called from `main()`, which is, in turn, use stack for its own needs, zapping 100-byte buffer. A random garbage will be printed at the best.

Hard to believe, but I know how to fix this problem:

```
#include <stdio.h>

char* amsg(int n, char* s)
{
    char buf[100];

    sprintf (buf, "error %d: %s\n", n, s) ;

    return buf;
};

char* interim (int n, char* s)
{
    char large_buf[8000];
    // make use of local array.
    // it will be optimized away otherwise, as useless.
    large_buf[0]=0;
    return amsg (n, s);
};

int main()
{
    printf ("%s\n", interim (1234, "something wrong!"));
};
```

It will work if compiled by MSVC 2013 with no optimizations and with `/GS-` option<sup>56</sup>. MSVC will warn: “warning C4172: returning address of local variable or temporary”, but the code will run and message will be printed. Let’s see stack state at the moment when `amsg()` returns control to `interim()`:

```
(lower addresses)
...
[amsg(): 100 bytes]
[RA]                <- current SP
[two amsg() arguments]
[interim() stuff, incl. 8000 bytes]
[something else]
[main() local variables]
...
(upper addresses)
```

<sup>56</sup>Turn off buffer security check

(upper addresses)

Now the stack state at the moment when `interim()` returns control to `main()`:

(lower addresses)

...

[`amsg()`: 100 bytes]

[RA]

[two `amsg()` arguments]

[`interim()` stuff, incl. 8000 bytes]

[something else]

<- current SP

[`main()` local variables]

...

(upper addresses)

So when `main()` calls `printf()`, it uses stack at the place where `interim()`'s buffer was allocated, and doesn't zap 100 bytes with error message inside, because 8000 bytes (or maybe much less) is just enough for everything `printf()` and other descending functions do!

It may also work if there are many functions between, like: `main()` → `f1()` → `f2()` → `f3()` ... → `amsg()`, and then the result of `amsg()` is used in `main()`. The distance between `SP` in `main()` and address of `buf[]` must be long enough,

This is why bugs like these are dangerous: sometimes your code works (and bug can be hiding unnoticed), sometimes not. Bugs like these are jokingly called *heisenbugs* or *schrödinbugs*.

## 3.29 OpenMP

OpenMP is one of the simplest ways to parallelize simple algorithms.

As an example, let's try to build a program to compute a cryptographic *nonce*.

In my simplistic example, the *nonce* is a number added to the plain unencrypted text in order to produce a hash with some specific features.

For example, at some step, the Bitcoin protocol requires to find such *nonce* so the resulting hash contains a specific number of consecutive zeros. This is also called *proof of work* (i.e., the system proves that it did some intensive calculations and spent some time for it).

My example is not related to Bitcoin in any way, it will try to add numbers to the "hello, world!" string in order to find such number that when "hello, world!\_<number>" is hashed with the SHA512 algorithm, it will contain at least 3 zero bytes.

Let's limit our brute-force to the interval in `0..INT32_MAX-1` (i.e., `0x7FFFFFFE` or `2147483646`).

The algorithm is pretty straightforward:

```
#include <stdio.h>
#include <string.h>
#include <stdlib.h>
#include <time.h>
#include "sha512.h"

int found=0;
int32_t checked=0;

int32_t* __min;
int32_t* __max;

time_t start;

#ifdef __GNUC__
#define min(X,Y) ((X) < (Y) ? (X) : (Y))
#define max(X,Y) ((X) > (Y) ? (X) : (Y))
```

```

#endif

void check_nonce (int32_t nonce)
{
    uint8_t buf[32];
    struct sha512_ctx ctx;
    uint8_t res[64];

    // update statistics
    int t=omp_get_thread_num();

    if (__min[t]==-1)
        __min[t]=nonce;
    if (__max[t]==-1)
        __max[t]=nonce;

    __min[t]=min(__min[t], nonce);
    __max[t]=max(__max[t], nonce);

    // idle if valid nonce found
    if (found)
        return;

    memset (buf, 0, sizeof(buf));
    sprintf (buf, "hello, world!_%d", nonce);

    sha512_init_ctx (&ctx);
    sha512_process_bytes (buf, strlen(buf), &ctx);
    sha512_finish_ctx (&ctx, &res);
    if (res[0]==0 && res[1]==0 && res[2]==0)
    {
        printf ("found (thread %d): [%s]. seconds spent=%d\n", t, buf, time(NULL)-start);
        found=1;
    };
    #pragma omp atomic
    checked++;

    #pragma omp critical
    if ((checked % 100000)==0)
        printf ("checked=%d\n", checked);
};

int main()
{
    int32_t i;
    int threads=omp_get_max_threads();
    printf ("threads=%d\n", threads);

    __min=(int32_t*)malloc(threads*sizeof(int32_t));
    __max=(int32_t*)malloc(threads*sizeof(int32_t));
    for (i=0; i<threads; i++)
        __min[i]=__max[i]=-1;

    start=time(NULL);

    #pragma omp parallel for
    for (i=0; i<INT32_MAX; i++)
        check_nonce (i);

    for (i=0; i<threads; i++)
        printf ("__min[%d]=0x%08x __max[%d]=0x%08x\n", i, __min[i], i, __max[i]);

    free(__min); free(__max);
};

```

The `check_nonce()` function just adds a number to the string, hashes it with the SHA512 algorithm and checks for 3 zero bytes in the result.

A very important part of the code is:

```
#pragma omp parallel for
for (i=0; i<INT32_MAX; i++)
    check_nonce (i);
```

Yes, that simple, without #pragma we just call check\_nonce() for each number from 0 to INT32\_MAX (0x7fffffff or 2147483647). With #pragma, the compiler adds some special code which slices the loop interval into smaller ones, to run them on all CPU cores available <sup>57</sup>.

The example can be compiled <sup>58</sup> in MSVC 2012:

```
cl openmp_example.c sha512.obj /openmp /O1 /Zi /Faopenmp_example.asm
```

Or in GCC:

```
gcc -fopenmp 2.c sha512.c -S -masm=intel
```

### 3.29.1 MSVC

Now this is how MSVC 2012 generates the main loop:

Listing 3.125: MSVC 2012

```
push    OFFSET _main$omp$1
push    0
push    1
call    __vcomp_fork
add     esp, 16
```

All functions prefixed by vcomp are OpenMP-related and are stored in the vcomp\*.dll file. So here a group of threads is started.

Let's take a look on \_main\$omp\$1:

Listing 3.126: MSVC 2012

```
$T1 = -8      ; size = 4
$T2 = -4      ; size = 4
_main$omp$1 PROC
    push    ebp
    mov     ebp, esp
    push    ecx
    push    ecx
    push    esi
    lea    eax, DWORD PTR $T2[ebp]
    push    eax
    lea    eax, DWORD PTR $T1[ebp]
    push    eax
    push    1
    push    1
    push    2147483646      ; 7fffffffH
    push    0
    call    __vcomp_for_static_simple_init
    mov     esi, DWORD PTR $T1[ebp]
    add     esp, 24
    jmp     SHORT $LN6@main$omp$1
$LL2@main$omp$1:
    push    esi
    call    _check_nonce
    pop     ecx
    inc     esi
$LN6@main$omp$1:
    cmp     esi, DWORD PTR $T2[ebp]
```

<sup>57</sup>N.B.: This is intentionally simplest possible example, but in practice, the usage of OpenMP can be harder and more complex

<sup>58</sup>sha512.c(h) and u64.h files can be taken from the OpenSSL library: <http://go.yurichev.com/17324>



```

    jle     SHORT $LL2@main$omp$1
    call   __vcomp_for_static_end
    pop    esi
    leave
    ret    0
_main$omp$1 ENDP

```

This function is to be started  $n$  times in parallel, where  $n$  is the number of CPU cores.

`vcomp_for_static_simple_init()` calculates the interval for the `for()` construct for the current thread, depending on the current thread's number.

The loop's start and end values are stored in the `$T1` and `$T2` local variables. You may also notice `7fffffffh` (or `2147483646`) as an argument to the `vcomp_for_static_simple_init()` function—this is the number of iterations for the whole loop, to be divided evenly.

Then we see a new loop with a call to the `check_nonce()` function, which does all the work.

Let's also add some code at the beginning of the `check_nonce()` function to gather statistics about the arguments with which the function has been called.

This is what we see when we run it:

```

threads=4
...
checked=2800000
checked=3000000
checked=3200000
checked=3300000
found (thread 3): [hello, world!_1611446522]. seconds spent=3
__min[0]=0x00000000 __max[0]=0x1fffffff
__min[1]=0x20000000 __max[1]=0x3fffffff
__min[2]=0x40000000 __max[2]=0x5fffffff
__min[3]=0x60000000 __max[3]=0x7fffffff

```

Yes, the result is correct, the first 3 bytes are zeros:

```

C:\...\sha512sum test
000000f4a8fac5a4ed38794da4c1e39f54279ad5d9bb3c5465cdf57adaf60403
df6e3fe6019f5764fc9975e505a7395fed780fee50eb38dd4c0279cb114672e2 *test

```

The running time is  $\approx 2.3$  seconds on 4-core Intel Xeon E3-1220 3.10 GHz. In the task manager we see 5 threads: 1 main thread + 4 more. No further optimizations are done to keep this example as small and clear as possible. But probably it can be done much faster. My CPU has 4 cores, that is why OpenMP started exactly 4 threads.

By looking at the statistics table we can clearly see how the loop has been sliced into 4 even parts. Oh well, almost even, if we don't consider the last bit.

There are also pragmas for [atomic operations](#).

Let's see how this code is compiled:

```

#pragma omp atomic
checked++;

#pragma omp critical
if ((checked % 100000)==0)
    printf ("checked=%d\n", checked);

```

Listing 3.127: MSVC 2012

```

    push   edi
    push   OFFSET _checked
    call   __vcomp_atomic_add_i4
; Line 55
    push   OFFSET _$vcomp$critsect$

```

```

    call    __vcomp_enter_critsect
    add     esp, 12
; Line 56
    mov     ecx, DWORD PTR _checked
    mov     eax, ecx
    cdq
    mov     esi, 100000      ; 000186a0H
    idiv   esi
    test    edx, edx
    jne     SHORT $LN1@check_nonc
; Line 57
    push    ecx
    push    OFFSET ??_C@_0M@NPNHLI00@checked?$DN?$CFd?6?$AA@
    call    _printf
    pop     ecx
    pop     ecx
$LN1@check_nonc:
    push    DWORD PTR _$vcomp$critsect$
    call    __vcomp_leave_critsect
    pop     ecx

```

As it turns out, the `vcomp_atomic_add_i4()` function in the `vcomp*.dll` is just a tiny function with the `LOCK XADD` instruction<sup>59</sup> in it.

`vcomp_enter_critsect()` eventually calling win32 API function `EnterCriticalSection()`<sup>60</sup>.

### 3.29.2 GCC

GCC 4.8.1 produces a program which shows exactly the same statistics table, so, GCC's implementation divides the loop in parts in the same fashion.

Listing 3.128: GCC 4.8.1

```

mov     edi, OFFSET FLAT:main._omp_fn.0
call    GOMP_parallel_start
mov     edi, 0
call    main._omp_fn.0
call    GOMP_parallel_end

```

Unlike MSVC's implementation, what GCC code does is to start 3 threads, and run the fourth in the current thread. So there are 4 threads instead of the 5 in MSVC.

Here is the `main._omp_fn.0` function:

Listing 3.129: GCC 4.8.1

```

main._omp_fn.0:
    push    rbp
    mov     rbp, rsp
    push    rbx
    sub     rsp, 40
    mov     QWORD PTR [rbp-40], rdi
    call    omp_get_num_threads
    mov     ebx, eax
    call    omp_get_thread_num
    mov     esi, eax
    mov     eax, 2147483647 ; 0x7FFFFFFF
    cdq
    idiv   ebx
    mov     ecx, eax
    mov     eax, 2147483647 ; 0x7FFFFFFF
    cdq
    idiv   ebx
    mov     eax, edx

```

<sup>59</sup>Read more about LOCK prefix: [.1.6 on page 1027](#)

<sup>60</sup>You can read more about critical sections here: [6.5.4 on page 789](#)

```

        cmp     esi, eax
        jl     .L15
.L18:
        imul   esi, ecx
        mov    edx, esi
        add    eax, edx
        lea   ebx, [rax+rcx]
        cmp    eax, ebx
        jge   .L14
        mov   DWORD PTR [rbp-20], eax
.L17:
        mov   eax, DWORD PTR [rbp-20]
        mov   edi, eax
        call  check_nonce
        add   DWORD PTR [rbp-20], 1
        cmp   DWORD PTR [rbp-20], ebx
        jl   .L17
        jmp  .L14
.L15:
        mov   eax, 0
        add   ecx, 1
        jmp  .L18
.L14:
        add   rsp, 40
        pop   rbx
        pop   rbp
        ret

```

Here we see the division clearly: by calling `omp_get_num_threads()` and `omp_get_thread_num()` we get the number of threads running, and also the current thread's number, and then determine the loop's interval. Then we run `check_nonce()`.

GCC also inserted the `LOCK ADD`

instruction right in the code, unlike MSVC, which generated a call to a separate DLL function:

Listing 3.130: GCC 4.8.1

```

lock add     DWORD PTR checked[rip], 1
call        GOMP_critical_start
mov         ecx, DWORD PTR checked[rip]
mov         edx, 351843721
mov         eax, ecx
imul        edx
sar         edx, 13
mov         eax, ecx
sar         eax, 31
sub         edx, eax
mov         eax, edx
imul        eax, eax, 100000
sub         ecx, eax
mov         eax, ecx
test        eax, eax
jne         .L7
mov         eax, DWORD PTR checked[rip]
mov         esi, eax
mov         edi, OFFSET FLAT:.LC2 ; "checked=%d\n"
mov         eax, 0
call        printf
.L7:
call        GOMP_critical_end

```

The functions prefixed with GOMP are from GNU OpenMP library. Unlike `vcomp*.dll`, its source code is freely available: [GitHub](#).

### 3.30 Signed division using shifts

Unsigned division by  $2^n$  numbers is easy, just use bit shift right by  $n$ . Signed division by  $2^n$  is easy as well, but some correction needs to be done before or after shift operation.

First, most CPU architectures support two right shift operations: logical and arithmetical. During logical shift right, free bit(s) at left are set to zero bit(s). This is SHR in x86. During arithmetical shift right, free bit(s) at left are set equal to the bit which was at the same place. Thus, it preserves sign bit while shifting. This is SAR in x86.

Interesting to know, there is no special instruction for arithmetical shift left, because it works just as logical shift left. So, SAL and SHL instructions in x86 are mapped to the same opcode. Many disassemblers don't even know about SAL instruction and decode this opcode as SHL.

Hence, arithmetical shift right is used for signed numbers. For example, if you shift -4 (11111100b) by 1 bit right, logical shift right operation will produce 01111110b, which is 126. Arithmetical shift right will produce 11111110b, which is -2. So far so good.

What if we need to divide -5 by 2? This is -2.5, or just -2 in integer arithmetic. -5 is 11111011b, by shifting this value by 1 bit right, we'll get 11111101b, which is -3. This is slightly incorrect.

Another example:  $-\frac{1}{2} = -0.5$  or just 0 in integer arithmetic. But -1 is 11111111b, and  $11111111b \gg 1 = 11111111b$ , which is -1 again. This is also incorrect.

One solution is to add 1 to the input value if it's negative.

That is why, if we compile  $x/2$  expression, where  $x$  is *signed int*, GCC 4.8 will produce something like that:

```

mov    eax, edi
shr    eax, 31 ; isolate leftmost bit, which is 1 if the number is negative and 0 if
positive
add    eax, edi ; add 1 to the input value if it's negative, do nothing otherwise
sar    eax     ; arithmetical shift right by one bit
ret

```

If you divide by 4, 3 needs to be added to the input value if it's negative. So this is what GCC 4.8 does for  $x/4$ :

```

lea    eax, [rdi+3] ; prepare x+3 value ahead of time
test   edi, edi

; if the sign is not negative (i.e., positive), move input value to EAX
; if the sign is negative, x+3 value is left in EAX untouched
cmovns eax, edi
; do arithmetical shift right by 2 bits
sar    eax, 2
ret

```

If you divide by 8, 7 will be added to the input value, etc.

MSVC 2013 is slightly different. This is division by 2:

```

mov    eax, DWORD PTR _a$[esp-4]
; sign-extend input value to 64-bit value into EDX:EAX
; effectively, that means EDX will be set to 0FFFFFFFFh if the input value is negative
; ... or to 0 if positive
cdq
; subtract -1 from input value if it's negative
; this is the same as adding 1
sub    eax, edx
; do arithmetical shift right
sar    eax, 1
ret    0

```

Division by 4 in MSVC 2013 is little more complex:

```

mov    eax, DWORD PTR _a$[esp-4]
cdq
; now EDX is 0FFFFFFFFh if input value is negative
; EDX is 0 if it's positive

```

```

and    edx, 3
; now EDX is 3 if input is negative or 0 otherwise
; add 3 to input value if it's negative or do nothing otherwise:
add    eax, edx
; do arithmetical shift
sar    eax, 2
ret    0

```

Division by 8 in MSVC 2013 is similar, but 3 bits from EDX is taken instead of 2, producing correction value of 7 instead of 3.

Sometimes, Hex-Rays 6.8 can't handle such code correctly, and it may produce something like this:

```

int v0;
...
__int64 v14
...

v14 = ...;
v0 = ((signed int)v14 - HIDWORD(v14)) >> 1;

```

... it can be safely rewritten to  $v0=v14/2$ .

Hex-Rays 6.8 can also handle signed division by 4 like that:

```

result = ((BYTE4(v25) & 3) + (signed int)v25) >> 2;

```

... can be rewritten to  $v25 / 4$ .

Also, such correction code is used often when division is replaced by multiplication by *magic numbers*: read Mathematics for Programmers<sup>61</sup> about multiplicative inverse. And sometimes, additional shifting is used after multiplication. For example, when GCC optimizes  $\frac{x}{10}$ , it can't find multiplicative inverse for 10, because diophantine equation has no solutions. So it generates code for  $\frac{x}{5}$  and then adds arithmetical shift right operation by 1 bit, to divide the result by 2. Of course, this is true only for signed integers.

So here is division by 10 by GCC 4.8:

```

mov    eax, edi
mov    edx, 1717986919 ; magic number
sar    edi, 31         ; isolate leftmost bit (which reflects sign)
imul   edx             ; multiplication by magic number (calculate x/5)
sar    edx, 2         ; now calculate (x/5)/2

; subtract -1 (or add 1) if the input value is negative.
; do nothing otherwise:
sub    edx, edi
mov    eax, edx
ret

```

Summary:  $2^n - 1$  must be added to input value before arithmetical shift, or 1 must be added to the final result after shift. Both operations are equivalent to each other, so compiler developers may choose what is more suitable to them. From the reverse engineer's point of view, this correction is a clear evidence that the value has signed type.

### 3.31 Another heisenbug

Sometimes, array (or buffer) can overflow due to *fencepost error*:

<sup>61</sup><https://yurichev.com/writings/Math-for-programmers.pdf>

```

#include <stdio.h>

int array1[128];
int important_var1;
int important_var2;
int important_var3;
int important_var4;
int important_var5;

int main()
{
    important_var1=1;
    important_var2=2;
    important_var3=3;
    important_var4=4;
    important_var5=5;

    array1[0]=123;
    array1[128]=456; // BUG

    printf ("important_var1=%d\n", important_var1);
    printf ("important_var2=%d\n", important_var2);
    printf ("important_var3=%d\n", important_var3);
    printf ("important_var4=%d\n", important_var4);
    printf ("important_var5=%d\n", important_var5);
};

```

This is what this program printed in my case (non-optimized GCC 5.4 x86 on Linux):

```

important_var1=1
important_var2=456
important_var3=3
important_var4=4
important_var5=5

```

As it happens, `important_var2` has been placed by compiler right after `array1[]`:

Listing 3.131: `objdump -x`

0804a040	g	0	.bss	00000200	array1
...					
0804a240	g	0	.bss	00000004	important_var2
0804a244	g	0	.bss	00000004	important_var4
...					
0804a248	g	0	.bss	00000004	important_var1
0804a24c	g	0	.bss	00000004	important_var3
0804a250	g	0	.bss	00000004	important_var5

Another compiler can arrange variables in another order, and another variable would be zapped. This is also *heisenbug* ( [3.28.2 on page 636](#))—bug may appear or may left unnoticed depending on compiler version and optimization switches.

If all variables and arrays are allocated in local stack, stack protection may be triggered, or may not. However, Valgrind can find bugs like these.

Related example in the book (Angband game): [1.27 on page 303](#).

## 3.32 The case of forgotten return

Let's revisit the "attempt to use the result of a function returning *void*" part: .

This is a bug I once hit.

And this is also yet another demonstration, how C/C++ places return value into EAX/RAX register.

In the piece of code like that, I forgot to add `return`:

```

#include <stdio.h>
#include <stdlib.h>

struct color
{
    int R;
    int G;
    int B;
};

struct color* create_color (int R, int G, int B)
{
    struct color* rt=(struct color*)malloc(sizeof(struct color));

    rt->R=R;
    rt->G=G;
    rt->B=B;
    // must be "return rt;" here
};

int main()
{
    struct color* a=create_color(1,2,3);
    printf ("%d %d %d\n", a->R, a->G, a->B);
};

```

Non-optimizing GCC 5.4 silently compiles this with no warnings. And the code works! Let's see, why:

Listing 3.132: Non-optimizing GCC 5.4

```

create_color:
    push    rbp
    mov     rbp, rsp
    sub    rsp, 32
    mov    DWORD PTR [rbp-20], edi
    mov    DWORD PTR [rbp-24], esi
    mov    DWORD PTR [rbp-28], edx
    mov    edi, 12
    call   malloc
; RAX is pointer to newly allocated buffer
; now fill it with R/G/B:
    mov    QWORD PTR [rbp-8], rax
    mov    rax, QWORD PTR [rbp-8]
    mov    edx, DWORD PTR [rbp-20]
    mov    DWORD PTR [rax], edx
    mov    rax, QWORD PTR [rbp-8]
    mov    edx, DWORD PTR [rbp-24]
    mov    DWORD PTR [rax+4], edx
    mov    rax, QWORD PTR [rbp-8]
    mov    edx, DWORD PTR [rbp-28]
    mov    DWORD PTR [rax+8], edx
    nop
    leave
; RAX wasn't modified till that point!
    ret

```

If I add `return rt;`, the only instruction is added at the end, which is redundant:

Listing 3.133: Non-optimizing GCC 5.4

```

create_color:
    push    rbp
    mov     rbp, rsp
    sub    rsp, 32
    mov    DWORD PTR [rbp-20], edi
    mov    DWORD PTR [rbp-24], esi
    mov    DWORD PTR [rbp-28], edx
    mov    edi, 12
    call   malloc
; RAX is pointer to buffer

```

```

mov     QWORD PTR [rbp-8], rax
mov     rax, QWORD PTR [rbp-8]
mov     edx, DWORD PTR [rbp-20]
mov     DWORD PTR [rax], edx
mov     rax, QWORD PTR [rbp-8]
mov     edx, DWORD PTR [rbp-24]
mov     DWORD PTR [rax+4], edx
mov     rax, QWORD PTR [rbp-8]
mov     edx, DWORD PTR [rbp-28]
mov     DWORD PTR [rax+8], edx
; reload pointer to RAX again, and this is redundant operation...
mov     rax, QWORD PTR [rbp-8] ; new instruction
leave
ret

```

Bugs like that are very dangerous, sometimes they appear, sometimes hide. It's like Heisenbug.

Now I'm trying optimizing GCC:

Listing 3.134: Optimizing GCC 5.4

```

create_color:
    rep ret

main:
    xor     eax, eax
; as if create_color() was called and returned 0
    sub     rsp, 8
    mov     r8d, DWORD PTR ds:8
    mov     ecx, DWORD PTR [rax+4]
    mov     edx, DWORD PTR [rax]
    mov     esi, OFFSET FLAT:.LC1
    mov     edi, 1
    call   __printf_chk
    xor     eax, eax
    add     rsp, 8
    ret

```

Compiler deducing that nothing returns from the function, so it optimizes it away. And it assumes, that is returns 0 by default. The zero is then used as an address to a structure in main(). Of course, this code crashes.

GCC is C++ mode silent about it as well.

Let's try non-optimizing MSVC 2015 x86. It warns about the problem:

```
c:\tmp\3.c(19) : warning C4716: 'create_color': must return a value
```

And generates crashing code:

Listing 3.135: Non-optimizing MSVC 2015 x86

```

_rt$ = -4
_R$ = 8
_G$ = 12
_B$ = 16
_create_color PROC
    push    ebp
    mov     ebp, esp
    push    ecx
    push    12
    call   _malloc
; EAX -> ptr to buffer
    add     esp, 4
    mov     DWORD PTR _rt$[ebp], eax
    mov     eax, DWORD PTR _rt$[ebp]
    mov     ecx, DWORD PTR _R$[ebp]
    mov     DWORD PTR [eax], ecx
    mov     edx, DWORD PTR _rt$[ebp]
    mov     eax, DWORD PTR _G$[ebp]

```



```

; EAX is set to G argument:
    mov     DWORD PTR [edx+4], eax
    mov     ecx, DWORD PTR _rt$[ebp]
    mov     edx, DWORD PTR _B$[ebp]
    mov     DWORD PTR [ecx+8], edx
    mov     esp, ebp
    pop     ebp
; EAX = G at this point:
    ret     0
_create_color ENDP

```

Now optimizing MSVC 2015 x86 generates crashing code as well, but for the different reason:

Listing 3.136: Optimizing MSVC 2015 x86

```

_a$ = -4
_main PROC
; this is inlined optimized version of create_color():
    push    ecx
    push    12
    call    _malloc
    mov     DWORD PTR [eax], 1
    mov     DWORD PTR [eax+4], 2
    mov     DWORD PTR [eax+8], 3
; EAX -> to allocated buffer, and it's filled, OK
; now we reload ptr to buffer, thinking it's in "a" variable
; but inlined function didn't store pointer to "a" variable!
    mov     eax, DWORD PTR _a$[esp+8]
; EAX = some random garbage at this point
    push    DWORD PTR [eax+8]
    push    DWORD PTR [eax+4]
    push    DWORD PTR [eax]
    push    OFFSET $SG6074
    call    _printf
    xor     eax, eax
    add     esp, 24
    ret     0
_main ENDP

_R$ = 8
_G$ = 12
_B$ = 16
_create_color PROC
    push    12
    call    _malloc
    mov     ecx, DWORD PTR _R$[esp]
    add     esp, 4
    mov     DWORD PTR [eax], ecx
    mov     ecx, DWORD PTR _G$[esp-4]
    mov     DWORD PTR [eax+4], ecx
    mov     ecx, DWORD PTR _B$[esp-4]
    mov     DWORD PTR [eax+8], ecx
; EAX -> to allocated buffer, OK
    ret     0
_create_color ENDP

```

However, non-optimizing MSVC 2015 x64 generates working code:

Listing 3.137: Non-optimizing MSVC 2015 x64

```

rt$ = 32
R$ = 64
G$ = 72
B$ = 80
create_color PROC
    mov     DWORD PTR [rsp+24], r8d
    mov     DWORD PTR [rsp+16], edx
    mov     DWORD PTR [rsp+8], ecx
    sub     rsp, 56
    mov     ecx, 12
    call    malloc

```

```

; RAX = allocated buffer
mov     QWORD PTR rt$[rsp], rax
mov     rax, QWORD PTR rt$[rsp]
mov     ecx, DWORD PTR R$[rsp]
mov     DWORD PTR [rax], ecx
mov     rax, QWORD PTR rt$[rsp]
mov     ecx, DWORD PTR G$[rsp]
mov     DWORD PTR [rax+4], ecx
mov     rax, QWORD PTR rt$[rsp]
mov     ecx, DWORD PTR B$[rsp]
mov     DWORD PTR [rax+8], ecx
add     rsp, 56
; RAX didn't change down to this point
ret     0
create_color ENDP

```

Optimizing MSVC 2015 x64 also inlines the function, as in case of x86, and the resulting code also crashes.

This is a real piece of code from my *octothorpe* library<sup>62</sup>, that worked and all tests passed. It was so, without return for quite a time...

```

uint32_t LPHM_u32_hash(void *key)
{
    jenkins_one_at_a_time_hash_u32((uint32_t)key);
}

```

The moral of the story: warnings are very important, use `-Wall`, etc, etc... When return statement is absent, compiler can just silently do nothing at that point.

Such a bug left unnoticed can ruin a day.

Also, *shotgun debugging* is bad, because again, such a bug can left unnoticed (“everything works now, so be it”).

### 3.33 Homework: more about function pointers and unions

This code was copy-pasted from *dwm*<sup>63</sup>, probably, the smallest ever Linux window manager.

The problem: keystrokes from user must be dispatched to various functions inside of *dwm*. This is usually solved using a big `switch()`. Supposedly, *dwm*’s creators wanted to make the code neat and modifiable by users:

```

...
typedef union {
    int i;
    unsigned int ui;
    float f;
    const void *v;
} Arg;
...
typedef struct {
    unsigned int mod;
    KeySym keysym;
    void (*func)(const Arg *);
    const Arg arg;
} Key;
...

```

<sup>62</sup><https://github.com/DennisYurichev/octothorpe>

<sup>63</sup><https://dwm.suckless.org/>

```

static Key keys[] = {
    /* modifier          key          function          argument */
    { MODKEY,           XK_p,      spawn,           { .v = dmenucmd } },
    { MODKEY|ShiftMask, XK_Return, spawn,           { .v = termcmd } },
    { MODKEY,           XK_b,      togglebar,      {0} },
    { MODKEY,           XK_j,      focusstack,     { .i = +1 } },
    { MODKEY,           XK_k,      focusstack,     { .i = -1 } },
    { MODKEY,           XK_i,      incnmaster,     { .i = +1 } },
    { MODKEY,           XK_d,      incnmaster,     { .i = -1 } },
    { MODKEY,           XK_h,      setmfact,       { .f = -0.05 } },
    { MODKEY,           XK_l,      setmfact,       { .f = +0.05 } },
    { MODKEY,           XK_Return, zoom,           {0} },
    { MODKEY,           XK_Tab,    view,           {0} },
    { MODKEY|ShiftMask, XK_c,      killclient,     {0} },
    { MODKEY,           XK_t,      setlayout,      { .v = &layouts[0] },
    { MODKEY,           XK_f,      setlayout,      { .v = &layouts[1] },
    { MODKEY,           XK_m,      setlayout,      { .v = &layouts[2] },

    ...

void
spawn(const Arg *arg)
{
    ...

void
focusstack(const Arg *arg)
{
    ...

```

For each keystroke (or shortcut) a function is defined. Even more: a parameters (or arguments) to be passed to a function at each case. But parameters can have various type. So *union* is used here. A value of needed type is filled in the table. Each function takes what it needs.

As a homework, try to write a code like that, or get into *dwm*'s and see how union is passed into functions and handled.

## 3.34 Windows 16-bit

16-bit Windows programs are rare nowadays, but can be used in the cases of retrocomputing or dongle hacking ( [8.8 on page 829](#)).

16-bit Windows versions were up to 3.11. 95/98/ME also support 16-bit code, as well as the 32-bit versions of the [Windows NT](#) line. The 64-bit versions of [Windows NT](#) line do not support 16-bit executable code at all.

The code resembles MS-DOS's one.

Executable files are of type NE-type (so-called "new executable").

All examples considered here were compiled by the OpenWatcom 1.9 compiler, using these switches:

```
wcl.exe -i=C:/WATCOM/h/win/ -s -os -bt=windows -bcl=windows example.c
```

### 3.34.1 Example#1

```

#include <windows.h>

int PASCAL WinMain( HINSTANCE hInstance,
                   HINSTANCE hPrevInstance,
                   LPSTR lpCmdLine,
                   int nCmdShow )
{
    MessageBeep(MB_ICONEXCLAMATION);

```

```

    return 0;
};

```

```

WinMain      proc near
              push    bp
              mov     bp, sp
              mov     ax, 30h ; '0' ; MB_ICONEXCLAMATION constant
              push   ax
              call   MESSAGEBEEP
              xor    ax, ax      ; return 0
              pop    bp
              retn   0Ah
WinMain      endp

```

Seems to be easy, so far.

### 3.34.2 Example #2

```

#include <windows.h>

int PASCAL WinMain( HINSTANCE hInstance,
                   HINSTANCE hPrevInstance,
                   LPSTR lpCmdLine,
                   int nCmdShow )
{
    MessageBox (NULL, "hello, world", "caption", MB_YESNOCANCEL);
    return 0;
};

```

```

WinMain      proc near
              push    bp
              mov     bp, sp
              xor    ax, ax      ; NULL
              push   ax
              push   ds
              mov     ax, offset aHelloWorld ; 0x18. "hello, world"
              push   ax
              push   ds
              mov     ax, offset aCaption ; 0x10. "caption"
              push   ax
              mov     ax, 3      ; MB_YESNOCANCEL
              push   ax
              call   MESSAGEBOX
              xor    ax, ax      ; return 0
              pop    bp
              retn   0Ah
WinMain      endp

dseg02:0010 aCaption      db 'caption',0
dseg02:0018 aHelloWorld  db 'hello, world',0

```

Couple important things here: the PASCAL calling convention dictates passing the first argument first (MB\_YESNOCANCEL), and the last argument—last (NULL). This convention also tells the [callee](#) to restore the [stack pointer](#): hence the RETN instruction has 0Ah as argument, which implies that the pointer has to be increased by 10 bytes when the function exits. It is like stdcall ( [6.1.2 on page 735](#)), but the arguments are passed in “natural” order.

The pointers are passed in pairs: first the data segment is passed, then the pointer inside the segment. There is only one segment in this example, so DS always points to the data segment of the executable.

### 3.34.3 Example #3

```

#include <windows.h>

int PASCAL WinMain( HINSTANCE hInstance,
                   HINSTANCE hPrevInstance,
                   LPSTR lpCmdLine,
                   int nCmdShow )
{
    int result=MessageBox (NULL, "hello, world", "caption", MB_YESNOCANCEL);

    if (result==IDCANCEL)
        MessageBox (NULL, "you pressed cancel", "caption", MB_OK);
    else if (result==IDYES)
        MessageBox (NULL, "you pressed yes", "caption", MB_OK);
    else if (result==IDNO)
        MessageBox (NULL, "you pressed no", "caption", MB_OK);

    return 0;
};

```

```

WinMain      proc near
              push    bp
              mov     bp, sp
              xor     ax, ax          ; NULL
              push   ax
              push   ds
              mov     ax, offset aHelloWorld ; "hello, world"
              push   ax
              push   ds
              mov     ax, offset aCaption ; "caption"
              push   ax
              mov     ax, 3          ; MB_YESNOCANCEL
              push   ax
              call   MESSAGEBOX
              cmp     ax, 2          ; IDCANCEL
              jnz    short loc_2F
              xor     ax, ax
              push   ax
              push   ds
              mov     ax, offset aYouPressedCanc ; "you pressed cancel"
              jmp     short loc_49
loc_2F:
              cmp     ax, 6          ; IDYES
              jnz    short loc_3D
              xor     ax, ax
              push   ax
              push   ds
              mov     ax, offset aYouPressedYes ; "you pressed yes"
              jmp     short loc_49
loc_3D:
              cmp     ax, 7          ; IDNO
              jnz    short loc_57
              xor     ax, ax
              push   ax
              push   ds
              mov     ax, offset aYouPressedNo ; "you pressed no"
loc_49:
              push   ax
              push   ds
              mov     ax, offset aCaption ; "caption"
              push   ax
              xor     ax, ax
              push   ax
              call   MESSAGEBOX
loc_57:
              xor     ax, ax
              pop    bp
              retn   0Ah
WinMain      endp

```

Somewhat extended example from the previous section .

### 3.34.4 Example #4

```
#include <windows.h>

int PASCAL func1 (int a, int b, int c)
{
    return a*b+c;
};

long PASCAL func2 (long a, long b, long c)
{
    return a*b+c;
};

long PASCAL func3 (long a, long b, long c, int d)
{
    return a*b+c-d;
};

int PASCAL WinMain( HINSTANCE hInstance,
                   HINSTANCE hPrevInstance,
                   LPSTR lpCmdLine,
                   int nCmdShow )
{
    func1 (123, 456, 789);
    func2 (600000, 700000, 800000);
    func3 (600000, 700000, 800000, 123);
    return 0;
};
```

```
func1          proc near

c              = word ptr 4
b              = word ptr 6
a              = word ptr 8

                push    bp
                mov     bp, sp
                mov     ax, [bp+a]
                imul   [bp+b]
                add     ax, [bp+c]
                pop     bp
                retn   6
func1          endp

func2          proc near

arg_0          = word ptr 4
arg_2          = word ptr 6
arg_4          = word ptr 8
arg_6          = word ptr 0Ah
arg_8          = word ptr 0Ch
arg_A          = word ptr 0Eh

                push    bp
                mov     bp, sp
                mov     ax, [bp+arg_8]
                mov     dx, [bp+arg_A]
                mov     bx, [bp+arg_4]
                mov     cx, [bp+arg_6]
                call    sub_B2 ; long 32-bit multiplication
                add     ax, [bp+arg_0]
                adc     dx, [bp+arg_2]
                pop     bp
                retn   12
func2          endp
```

```

func3          proc near
arg_0          = word ptr 4
arg_2          = word ptr 6
arg_4          = word ptr 8
arg_6          = word ptr 0Ah
arg_8          = word ptr 0Ch
arg_A          = word ptr 0Eh
arg_C          = word ptr 10h

                push    bp
                mov     bp, sp
                mov     ax, [bp+arg_A]
                mov     dx, [bp+arg_C]
                mov     bx, [bp+arg_6]
                mov     cx, [bp+arg_8]
                call    sub_B2 ; long 32-bit multiplication
                mov     cx, [bp+arg_2]
                add     cx, ax
                mov     bx, [bp+arg_4]
                adc     bx, dx          ; BX=high part, CX=low part
                mov     ax, [bp+arg_0]
                cwd     ; AX=low part d, DX=high part d
                sub     cx, ax
                mov     ax, cx
                sbb    bx, dx
                mov     dx, bx
                pop     bp
                retn   14
func3
WinMain        proc near
                push    bp
                mov     bp, sp
                mov     ax, 123
                push    ax
                mov     ax, 456
                push    ax
                mov     ax, 789
                push    ax
                call    func1
                mov     ax, 9          ; high part of 600000
                push    ax
                mov     ax, 27C0h     ; low part of 600000
                push    ax
                mov     ax, 0Ah       ; high part of 700000
                push    ax
                mov     ax, 0AE60h    ; low part of 700000
                push    ax
                mov     ax, 0Ch       ; high part of 800000
                push    ax
                mov     ax, 3500h     ; low part of 800000
                push    ax
                call    func2
                mov     ax, 9          ; high part of 600000
                push    ax
                mov     ax, 27C0h     ; low part of 600000
                push    ax
                mov     ax, 0Ah       ; high part of 700000
                push    ax
                mov     ax, 0AE60h    ; low part of 700000
                push    ax
                mov     ax, 0Ch       ; high part of 800000
                push    ax
                mov     ax, 3500h     ; low part of 800000
                push    ax
                mov     ax, 7Bh       ; 123
                push    ax
                call    func3
                xor     ax, ax        ; return 0

```

```

                pop     bp
                retn   0Ah
WinMain        endp

```

32-bit values (the long data type implies 32 bits, while *int* is 16-bit) in 16-bit code (both MS-DOS and Win16) are passed in pairs. It is just like when 64-bit values are used in a 32-bit environment ( [1.34 on page 395](#)).

sub\_B2 here is a library function written by the compiler's developers that does "long multiplication", i.e., multiplies two 32-bit values. Other compiler functions that do the same are listed here: [.5 on page 1044](#), [.4 on page 1044](#).

The ADD/ADC instruction pair is used for addition of compound values: ADD may set/clear the CF flag, and ADC uses it after.

The SUB/SBB instruction pair is used for subtraction: SUB may set/clear the CF flag, SBB uses it after.

32-bit values are returned from functions in the DX:AX register pair.

Constants are also passed in pairs in WinMain() here.

The *int*-typed 123 constant is first converted according to its sign into a 32-bit value using the CWD instruction.

### 3.34.5 Example #5

```

#include <windows.h>

int PASCAL string_compare (char *s1, char *s2)
{
    while (1)
    {
        if (*s1!=*s2)
            return 0;
        if (*s1==0 || *s2==0)
            return 1; // end of string
        s1++;
        s2++;
    };
};

int PASCAL string_compare_far (char far *s1, char far *s2)
{
    while (1)
    {
        if (*s1!=*s2)
            return 0;
        if (*s1==0 || *s2==0)
            return 1; // end of string
        s1++;
        s2++;
    };
};

void PASCAL remove_digits (char *s)
{
    while (*s)
    {
        if (*s>='0' && *s<='9')
            *s='-';
        s++;
    };
};

char str[]="hello 1234 world";

int PASCAL WinMain( HINSTANCE hInstance,
                   HINSTANCE hPrevInstance,

```



```

                LPSTR lpCmdLine,
                int nCmdShow )
{
    string_compare ("asd", "def");
    string_compare_far ("asd", "def");
    remove_digits (str);
    MessageBox (NULL, str, "caption", MB_YESNOCANCEL);
    return 0;
};

```

```
string_compare proc near
```

```
arg_0 = word ptr 4
arg_2 = word ptr 6
```

```

    push    bp
    mov     bp, sp
    push    si
    mov     si, [bp+arg_0]
    mov     bx, [bp+arg_2]

```

```
loc_12: ; CODE XREF: string_compare+21j
```

```

    mov     al, [bx]
    cmp     al, [si]
    jz      short loc_1C
    xor     ax, ax
    jmp     short loc_2B

```

```
loc_1C: ; CODE XREF: string_compare+Ej
```

```

    test    al, al
    jz      short loc_22
    jnz     short loc_27

```

```
loc_22: ; CODE XREF: string_compare+16j
```

```

    mov     ax, 1
    jmp     short loc_2B

```

```
loc_27: ; CODE XREF: string_compare+18j
```

```

    inc     bx
    inc     si
    jmp     short loc_12

```

```
loc_2B: ; CODE XREF: string_compare+12j
        ; string_compare+1Dj
```

```

    pop     si
    pop     bp
    retn   4

```

```
string_compare endp
```

```
string_compare_far proc near ; CODE XREF: WinMain+18p
```

```
arg_0 = word ptr 4
arg_2 = word ptr 6
arg_4 = word ptr 8
arg_6 = word ptr 0Ah
```

```

    push    bp
    mov     bp, sp
    push    si
    mov     si, [bp+arg_0]
    mov     bx, [bp+arg_4]

```

```
loc_3A: ; CODE XREF: string_compare_far+35j
```

```

    mov     es, [bp+arg_6]
    mov     al, es:[bx]
    mov     es, [bp+arg_2]
    cmp     al, es:[si]

```

```

    jz     short loc_4C
    xor     ax, ax
    jmp     short loc_67

loc_4C: ; CODE XREF: string_compare_far+16j
    mov     es, [bp+arg_6]
    cmp     byte ptr es:[bx], 0
    jz     short loc_5E
    mov     es, [bp+arg_2]
    cmp     byte ptr es:[si], 0
    jnz     short loc_63

loc_5E: ; CODE XREF: string_compare_far+23j
    mov     ax, 1
    jmp     short loc_67

loc_63: ; CODE XREF: string_compare_far+2Cj
    inc     bx
    inc     si
    jmp     short loc_3A

loc_67: ; CODE XREF: string_compare_far+1Aj
        ; string_compare_far+31j
    pop     si
    pop     bp
    retn    8
string_compare_far endp

remove_digits  proc near ; CODE XREF: WinMain+1Fp
arg_0 = word ptr 4

    push    bp
    mov     bp, sp
    mov     bx, [bp+arg_0]

loc_72: ; CODE XREF: remove_digits+18j
    mov     al, [bx]
    test    al, al
    jz     short loc_86
    cmp     al, 30h ; '0'
    jb     short loc_83
    cmp     al, 39h ; '9'
    ja     short loc_83
    mov     byte ptr [bx], 2Dh ; '-'

loc_83: ; CODE XREF: remove_digits+Ej
        ; remove_digits+12j
    inc     bx
    jmp     short loc_72

loc_86: ; CODE XREF: remove_digits+Aj
    pop     bp
    retn    2
remove_digits  endp

WinMain proc near ; CODE XREF: start+EDp
    push    bp
    mov     bp, sp
    mov     ax, offset aAsd ; "asd"
    push    ax
    mov     ax, offset aDef ; "def"
    push    ax
    call    string_compare
    push    ds
    mov     ax, offset aAsd ; "asd"

```

```

push    ax
push    ds
mov     ax, offset aDef ; "def"
push    ax
call    string_compare_far
mov     ax, offset aHello1234World ; "hello 1234 world"
push    ax
call    remove_digits
xor     ax, ax
push    ax
push    ds
mov     ax, offset aHello1234World ; "hello 1234 world"
push    ax
push    ds
mov     ax, offset aCaption ; "caption"
push    ax
mov     ax, 3 ; MB_YESNOCANCEL
push    ax
call    MESSAGEBOX
xor     ax, ax
pop     bp
retn   0Ah
WinMain endp

```

Here we see a difference between the so-called “near” pointers and the “far” pointers: another weird artifact of segmented memory in 16-bit 8086.

You can read more about it here: [11.6 on page 1000](#).

“near” pointers are those which point within the current data segment. Hence, the `string_compare()` function takes only two 16-bit pointers, and accesses the data from the segment that DS points to (The `mov al, [bx]` instruction actually works like `mov al, ds:[bx]` — DS is implicit here).

“far” pointers are those which may point to data in another memory segment. Hence `string_compare_far()` takes the 16-bit pair as a pointer, loads the high part of it in the ES segment register and accesses the data through it (`mov al, es:[bx]`). “far” pointers are also used in my `MessageBox()` win16 example: [3.34.2 on page 650](#). Indeed, the Windows kernel is not aware which data segment to use when accessing text strings, so it need the complete information.

The reason for this distinction is that a compact program may use just one 64kb data segment, so it doesn’t need to pass the high part of the address, which is always the same. A bigger program may use several 64kb data segments, so it needs to specify the segment of the data each time.

It’s the same story for code segments. A compact program may have all executable code within one 64kb-segment, then all functions in it will be called using the `CALL NEAR` instruction, and the code flow will be returned using `RETN`. But if there are several code segments, then the address of the function is to be specified by a pair, it is to be called using the `CALL FAR` instruction, and the code flow is to be returned using `RETF`.

This is what is set in the compiler by specifying “memory model”.

The compilers targeting MS-DOS and Win16 have specific libraries for each memory model: they differ by pointer types for code and data.

### 3.34.6 Example #6

```

#include <windows.h>
#include <time.h>
#include <stdio.h>

char strbuf[256];

int PASCAL WinMain( HINSTANCE hInstance,
                   HINSTANCE hPrevInstance,
                   LPSTR lpCmdLine,
                   int nCmdShow )
{
    struct tm *t;

```

```

time_t unix_time;

unix_time=time(NULL);

t=localtime (&unix_time);

sprintf (strbuf, "%04d-%02d-%02d %02d:%02d:%02d", t->tm_year+1900, t->tm_mon, t->tm_mday,
↳ tm_mday,
        t->tm_hour, t->tm_min, t->tm_sec);

MessageBox (NULL, strbuf, "caption", MB_OK);
return 0;
};

```

```

WinMain      proc near

var_4        = word ptr -4
var_2        = word ptr -2

        push    bp
        mov     bp, sp
        push    ax
        push    ax
        xor     ax, ax
        call   time_
        mov     [bp+var_4], ax    ; low part of UNIX time
        mov     [bp+var_2], dx    ; high part of UNIX time
        lea    ax, [bp+var_4]    ; take a pointer of high part
        call   localtime_
        mov     bx, ax           ; t
        push   word ptr [bx]     ; second
        push   word ptr [bx+2]   ; minute
        push   word ptr [bx+4]   ; hour
        push   word ptr [bx+6]   ; day
        push   word ptr [bx+8]   ; month
        mov    ax, [bx+0Ah]      ; year
        add    ax, 1900
        push   ax
        mov    ax, offset a04d02d02d02d02 ; "%04d-%02d-%02d %02d:%02d:%02d"
        push   ax
        mov    ax, offset strbuf
        push   ax
        call   sprintf_
        add    sp, 10h
        xor    ax, ax           ; NULL
        push   ax
        push   ds
        mov    ax, offset strbuf
        push   ax
        push   ds
        mov    ax, offset aCaption ; "caption"
        push   ax
        xor    ax, ax           ; MB_OK
        push   ax
        call   MESSAGEBOX
        xor    ax, ax
        mov    sp, bp
        pop    bp
        retn   0Ah

WinMain      endp

```

UNIX time is a 32-bit value, so it is returned in the DX:AX register pair and stored in two local 16-bit variables. Then a pointer to the pair is passed to the localtime() function. The localtime() function has a struct tm allocated somewhere in the guts of the C library, so only a pointer to it is returned.

By the way, this also implies that the function cannot be called again until its results are used.

For the time() and localtime() functions, a Watcom calling convention is used here: the first four arguments are passed in the AX, DX, BX and CX, registers, and the rest arguments are via the stack.

The functions using this convention are also marked by underscore at the end of their name.

`sprintf()` does not use the PASCAL calling convention, nor the Watcom one, so the arguments are passed in the normal *cdecl* way ( [6.1.1 on page 735](#)).

## Global variables

This is the same example, but now these variables are global:

```
#include <windows.h>
#include <time.h>
#include <stdio.h>

char strbuf[256];
struct tm *t;
time_t unix_time;

int PASCAL WinMain( HINSTANCE hInstance,
                   HINSTANCE hPrevInstance,
                   LPSTR lpCmdLine,
                   int nCmdShow )
{
    unix_time=time(NULL);

    t=localtime (&unix_time);

    sprintf (strbuf, "%04d-%02d-%02d %02d:%02d:%02d", t->tm_year+1900, t->tm_mon, t->tm_mday,
            t->tm_hour, t->tm_min, t->tm_sec);

    MessageBox (NULL, strbuf, "caption", MB_OK);
    return 0;
};
```

```
unix_time_low    dw 0
unix_time_high   dw 0
t                dw 0

WinMain          proc near
    push        bp
    mov         bp, sp
    xor         ax, ax
    call        time_
    mov         unix_time_low, ax
    mov         unix_time_high, dx
    mov         ax, offset unix_time_low
    call        localtime_
    mov         bx, ax
    mov         t, ax                ; will not be used in future...
    push        word ptr [bx]        ; seconds
    push        word ptr [bx+2]     ; minutes
    push        word ptr [bx+4]     ; hour
    push        word ptr [bx+6]     ; day
    push        word ptr [bx+8]     ; month
    mov         ax, [bx+0Ah]        ; year
    add         ax, 1900
    push        ax
    mov         ax, offset a04d02d02d02d02 ; "%04d-%02d-%02d %02d:%02d:%02d"
    push        ax
    mov         ax, offset strbuf
    push        ax
    call        sprintf_
    add         sp, 10h
    xor         ax, ax                ; NULL
    push        ax
    push        ds
    mov         ax, offset strbuf
    push        ax
    push        ds
```

```
        mov     ax, offset aCaption ; "caption"
        push   ax
        xor    ax, ax             ; MB_OK
        push   ax
        call   MESSAGEBOX
        xor    ax, ax             ; return 0
        pop    bp
        retn   0Ah
WinMain endp
```

t is not to be used, but the compiler emitted the code which stores the value.

Because it is not sure, maybe that value will eventually be used in some other module.

# Chapter 4

## Java

### 4.1 Java

#### 4.1.1 Introduction

There are some well-known decompilers for Java (or **JVM** bytecode in general) <sup>1</sup>.

The reason is the decompilation of **JVM**-bytecode is somewhat easier than for lower level x86 code:

- There is much more information about the data types.
- The **JVM** memory model is much more rigorous and outlined.
- The Java compiler don't do any optimizations (the **JVM JIT**<sup>2</sup> does them at runtime), so the bytecode in the class files is usually pretty readable.

When can the knowledge of **JVM** be useful?

- Quick-and-dirty patching tasks of class files without the need to recompile the decompiler's results.
- Analyzing obfuscated code.
- Analyzing of a code generated by newer Java compiler for which no updated decompiler exists yet.
- Building your own obfuscator.
- Building a compiler codegenerator (back-end) targeting **JVM** (like Scala, Clojure, etc. <sup>3</sup>).

Let's start with some simple pieces of code. JDK 1.7 is used everywhere, unless mentioned otherwise.

This is the command used to decompile class files everywhere:

```
javap -c -verbose.
```

This is the book I used while preparing all examples: [Tim Lindholm, Frank Yellin, Gilad Bracha, Alex Buckley, *The Java(R) Virtual Machine Specification / Java SE 7 Edition*] <sup>4</sup>.

#### 4.1.2 Returning a value

Probably the simplest Java function is the one which returns some value.

Oh, and we must keep in mind that there are no "free" functions in Java in common sense, they are "methods".

Each method is related to some class, so it's not possible to define a method outside of a class.

But we'll call them "functions" anyway, for simplicity.

```
public class ret
{
    public static int main(String[] args)
```

<sup>1</sup>For example, JAD: <http://varanekkas.com/jad/>

<sup>2</sup>Just-In-Time compilation

<sup>3</sup>Full list: [http://en.wikipedia.org/wiki/List\\_of\\_JVM\\_languages](http://en.wikipedia.org/wiki/List_of_JVM_languages)

<sup>4</sup>Also available as <https://docs.oracle.com/javase/specs/jvms/se7/jvms7.pdf>; <http://docs.oracle.com/javase/specs/jvms/se7/html/>

```
    {
        return 0;
    }
}
```

Let's compile it:

```
javac ret.java
```

...and decompile it using the standard Java utility:

```
javap -c -verbose ret.class
```

And we get:

Listing 4.1: JDK 1.7 (excerpt)

```
public static int main(java.lang.String[]);
  flags: ACC_PUBLIC, ACC_STATIC
  Code:
    stack=1, locals=1, args_size=1
     0: iconst_0
     1: ireturn
```

The Java developers decided that 0 is one of the busiest constants in programming, so there is a separate short one-byte `iconst_0` instruction which pushes 0

<sup>5</sup>. There are also `iconst_1` (which pushes 1), `iconst_2`, etc., up to `iconst_5`.

There is also `iconst_m1` which pushes -1.

The stack is used in JVM for passing data to called functions and also for return values. So `iconst_0` pushes 0 into the stack. `ireturn` returns an integer value (*i* in name means *integer*) from the [TOS](#)<sup>6</sup>.

Let's rewrite our example slightly, now we return 1234:

```
public class ret
{
    public static int main(String[] args)
    {
        return 1234;
    }
}
```

...we get:

Listing 4.2: JDK 1.7 (excerpt)

```
public static int main(java.lang.String[]);
  flags: ACC_PUBLIC, ACC_STATIC
  Code:
    stack=1, locals=1, args_size=1
     0: sipush      1234
     3: ireturn
```

`sipush` (*short integer*) pushes 1234 into the stack. *short* in name implies a 16-bit value is to be pushed. The number 1234 indeed fits well in a 16-bit value.

What about larger values?

<sup>5</sup>Just like in MIPS, where a separate register for zero constant exists: [1.5.4 on page 25](#).

<sup>6</sup>Top of Stack



```
public class ret
{
    public static int main(String[] args)
    {
        return 12345678;
    }
}
```

Listing 4.3: Constant pool

```
...
#2 = Integer          12345678
...
```

```
public static int main(java.lang.String[]);
  flags: ACC_PUBLIC, ACC_STATIC
  Code:
    stack=1, locals=1, args_size=1
     0: ldc          #2              // int 12345678
     2: ireturn
```

It's not possible to encode a 32-bit number in a JVM instruction opcode, the developers didn't leave such possibility.

So the 32-bit number 12345678 is stored in so called "constant pool" which is, let's say, the library of most used constants (including strings, objects, etc.).

This way of passing constants is not unique to JVM.

MIPS, ARM and other RISC CPUs also can't encode a 32-bit number in a 32-bit opcode, so the RISC CPU code (including MIPS and ARM) has to construct the value in several steps, or to keep it in the data segment: [1.39.3 on page 441](#), [1.40.1 on page 444](#).

MIPS code also traditionally has a constant pool, named "literal pool", the segments are called ".lit4" (for 32-bit single precision floating point number constants) and ".lit8" (for 64-bit double precision floating point number constants).

Let's try some other data types!

Boolean:

```
public class ret
{
    public static boolean main(String[] args)
    {
        return true;
    }
}
```

```
public static boolean main(java.lang.String[]);
  flags: ACC_PUBLIC, ACC_STATIC
  Code:
    stack=1, locals=1, args_size=1
     0: iconst_1
     1: ireturn
```

This JVM bytecode is no different from one returning integer 1.

32-bit data slots in the stack are also used here for boolean values, like in C/C++.

But one could not use returned boolean value as integer or vice versa — type information is stored in the class file and checked at runtime.

It's the same story with a 16-bit *short*:

```
public class ret
{
    public static short main(String[] args)
    {
        return 1234;
    }
}
```

```
public static short main(java.lang.String[]);
flags: ACC_PUBLIC, ACC_STATIC
Code:
    stack=1, locals=1, args_size=1
     0: sipush      1234
     3: ireturn
```

...and *char*!

```
public class ret
{
    public static char main(String[] args)
    {
        return 'A';
    }
}
```

```
public static char main(java.lang.String[]);
flags: ACC_PUBLIC, ACC_STATIC
Code:
    stack=1, locals=1, args_size=1
     0: bipush      65
     2: ireturn
```

bipush means “push byte”. Needless to say that a *char* in Java is 16-bit UTF-16 character, and it’s equivalent to *short*, but the ASCII code of the “A” character is 65, and it’s possible to use the instruction for pushing a byte in the stack.

Let’s also try a *byte*:

```
public class retc
{
    public static byte main(String[] args)
    {
        return 123;
    }
}
```

```
public static byte main(java.lang.String[]);
flags: ACC_PUBLIC, ACC_STATIC
Code:
    stack=1, locals=1, args_size=1
     0: bipush      123
     2: ireturn
```

One may ask, why bother with a 16-bit *short* data type which internally works as a 32-bit integer?

Why use a *char* data type if it is the same as a *short* data type?

The answer is simple: for data type control and source code readability.

A *char* may essentially be the same as a *short*, but we quickly grasp that it's a placeholder for an UTF-16 character, and not for some other integer value.

When using *short*, we show everyone that the variable's range is limited by 16 bits.

It's a very good idea to use the *boolean* type where needed to, instead of the C-style *int*.

There is also a 64-bit integer data type in Java:

```
public class ret3
{
    public static long main(String[] args)
    {
        return 1234567890123456789L;
    }
}
```

Listing 4.4: Constant pool

```
...
#2 = Long          1234567890123456789L
...
```

```
public static long main(java.lang.String[]);
  flags: ACC_PUBLIC, ACC_STATIC
  Code:
    stack=2, locals=1, args_size=1
     0: ldc2_w      #2          // long 1234567890123456789L
     3: lreturn
```

The 64-bit number is also stored in a constant pool, `ldc2_w` loads it and `lreturn` (*long return*) returns it.

The `ldc2_w` instruction is also used to load double precision floating point numbers (which also occupy 64 bits) from a constant pool:

```
public class ret
{
    public static double main(String[] args)
    {
        return 123.456d;
    }
}
```

Listing 4.5: Constant pool

```
...
#2 = Double        123.456d
...
```

```
public static double main(java.lang.String[]);
  flags: ACC_PUBLIC, ACC_STATIC
  Code:
    stack=2, locals=1, args_size=1
     0: ldc2_w      #2          // double 123.456d
     3: dreturn
```

`dreturn` stands for "return double".

And finally, a single precision floating point number:

```
public class ret
{
    public static float main(String[] args)
    {
        return 123.456f;
    }
}
```

Listing 4.6: Constant pool

```
...
#2 = Float          123.456f
...
```

```
public static float main(java.lang.String[]);
  flags: ACC_PUBLIC, ACC_STATIC
  Code:
    stack=1, locals=1, args_size=1
     0: ldc          #2              // float 123.456f
     2: freturn
```

The ldc instruction used here is the same one as for loading 32-bit integer numbers from a constant pool. freturn stands for “return float”.

Now what about function that return nothing?

```
public class ret
{
    public static void main(String[] args)
    {
        return;
    }
}
```

```
public static void main(java.lang.String[]);
  flags: ACC_PUBLIC, ACC_STATIC
  Code:
    stack=0, locals=1, args_size=1
     0: return
```

This means that the return instruction is used to return control without returning an actual value.

Knowing all this, it’s very easy to deduce the function’s (or method’s) returning type from the last instruction.

### 4.1.3 Simple calculating functions

Let’s continue with a simple calculating functions.

```
public class calc
{
    public static int half(int a)
    {
        return a/2;
    }
}
```

Here’s the output when the iconst\_2 instruction is used:

```

public static int half(int);
  flags: ACC_PUBLIC, ACC_STATIC
  Code:
    stack=2, locals=1, args_size=1
     0: iload_0
     1: iconst_2
     2: idiv
     3: ireturn

```

iload\_0 takes the zeroth function argument and pushes it to the stack.

iconst\_2 pushes 2 in the stack. After the execution of these two instructions, this is how stack looks like:

```

+---+
TOS ->| 2 |
+---+
| a |
+---+

```

idiv just takes the two values at the TOS, divides one by the other and leaves the result at TOS:

```

+-----+
TOS ->| result |
+-----+

```

ireturn takes it and returns.

Let's proceed with double precision floating point numbers:

```

public class calc
{
    public static double half_double(double a)
    {
        return a/2.0;
    }
}

```

Listing 4.7: Constant pool

```

...
#2 = Double          2.0d
...

```

```

public static double half_double(double);
  flags: ACC_PUBLIC, ACC_STATIC
  Code:
    stack=4, locals=2, args_size=1
     0: dload_0
     1: ldc2_w      #2          // double 2.0d
     4: ddiv
     5: dreturn

```

It's the same, but the ldc2\_w instruction is used to load the constant 2.0 from the constant pool.

Also, the other three instructions have the d prefix, meaning they work with double data type values.

Let's now use a function with two arguments:

```
public class calc
{
    public static int sum(int a, int b)
    {
        return a+b;
    }
}
```

```
public static int sum(int, int);
flags: ACC_PUBLIC, ACC_STATIC
Code:
    stack=2, locals=2, args_size=2
    0: iload_0
    1: iload_1
    2: iadd
    3: ireturn
```

iload\_0 loads the first function argument (a), iload\_1—second (b).  
Here is the stack after the execution of both instructions:

```
+---+
TOS ->| b |
+---+
    | a |
+---+
```

iadd adds the two values and leaves the result at [TOS](#):

```
+-----+
TOS ->| result |
+-----+
```

Let's extend this example to the *long* data type:

```
public static long lsum(long a, long b)
{
    return a+b;
}
```

...we got:

```
public static long lsum(long, long);
flags: ACC_PUBLIC, ACC_STATIC
Code:
    stack=4, locals=4, args_size=2
    0: lload_0
    1: lload_2
    2: ladd
    3: lreturn
```

The second lload instruction takes the second argument from the 2nd slot.  
That's because a 64-bit *long* value occupies exactly two 32-bit slots.  
Slightly more advanced example:

```
public class calc
{
    public static int mult_add(int a, int b, int c)
    {
        return a*b+c;
    }
}
```

```
public static int mult_add(int, int, int);
flags: ACC_PUBLIC, ACC_STATIC
Code:
    stack=2, locals=3, args_size=3
     0: iload_0
     1: iload_1
     2: imul
     3: iload_2
     4: iadd
     5: ireturn
```

The first step is multiplication. The product is left at the [TOS](#):

```
+-----+
TOS ->| product |
+-----+
```

`iload_2` loads the third argument (c) in the stack:

```
+-----+
TOS ->|   c   |
+-----+
      | product |
+-----+
```

Now the `iadd` instruction can add the two values.

#### 4.1.4 JVM memory model

x86 and other low-level environments use the stack for argument passing and as a local variables storage. [JVM](#) is slightly different.

It has:

- Local variable array ([LVA](#)<sup>7</sup>). Used as storage for incoming function arguments and local variables.
  - Instructions like `iload_0` load values from it.
  - `istore` stores values in it. At the beginning the function arguments are stored: starting at 0 or at 1 (if the zeroth argument is occupied by *this* pointer).
  - Then the local variables are allocated.
  - Each slot has size of 32-bit.
  - Hence, values of *long* and *double* data types occupy two slots.
- Operand stack (or just “stack”). It’s used for computations and passing arguments while calling other functions.
  - Unlike low-level environments like x86, it’s not possible to access the stack without using instructions which explicitly pushes or pops values to/from it.
- Heap. It is used as storage for objects and arrays.

These 3 areas are isolated from each other.

<sup>7</sup>(Java) Local Variable Array

### 4.1.5 Simple function calling

`Math.random()` returns a pseudorandom number in range of [0.0 ...1.0], but let's say that for some reason we need to devise a function that returns a number in range of [0.0 ...0.5]:

```
public class HalfRandom
{
    public static double f()
    {
        return Math.random()/2;
    }
}
```

Listing 4.8: Constant pool

```
...
#2 = Methodref      #18.#19    // java/lang/Math.random:()D
#3 = Double         2.0d
...
#12 = Utf8          ()D
...
#18 = Class         #22         // java/lang/Math
#19 = NameAndType   #23:#12    // random:()D
#22 = Utf8          java/lang/Math
#23 = Utf8          random
```

```
public static double f();
  flags: ACC_PUBLIC, ACC_STATIC
  Code:
    stack=4, locals=0, args_size=0
     0: invokestatic #2          // Method java/lang/Math.random:()D
     3: ldc2_w        #3          // double 2.0d
     6: ddiv
     7: dreturn
```

`invokestatic` calls the `Math.random()` function and leaves the result at the [TOS](#).

Then the result is divided by 2.0 and returned.

But how is the function name encoded?

It's encoded in the constant pool using a `Methodref` expression.

It defines the class and method names.

The first field of `Methodref` points to a `Class` expression which, in turn, points to the usual text string ("java/lang/Math").

The second `Methodref` expression points to a `NameAndType` expression which also has two links to the strings.

The first string is "random", which is the name of the method.

The second string is "()D", which encodes the function's type. It means that it returns a *double* value (hence the *D* in the string).

This is the way 1) JVM can check data for type correctness; 2) Java decompilers can restore data types from a compiled class file.

Now let's try the "Hello, world!" example:

```
public class HelloWorld
{
    public static void main(String[] args)
    {
        System.out.println("Hello, World");
    }
}
```



```
}
```

Listing 4.9: Constant pool

```
...
#2 = Fieldref      #16.#17    // java/lang/System.out:Ljava/io/PrintStream;
#3 = String        #18          // Hello, World
#4 = Methodref     #19.#20    // java/io/PrintStream.println:(Ljava/lang/String;)V
...
#16 = Class        #23          // java/lang/System
#17 = NameAndType  #24:#25    // out:Ljava/io/PrintStream;
#18 = Utf8         Hello, World
#19 = Class        #26          // java/io/PrintStream
#20 = NameAndType  #27:#28    // println:(Ljava/lang/String;)V
...
#23 = Utf8         java/lang/System
#24 = Utf8         out
#25 = Utf8         Ljava/io/PrintStream;
#26 = Utf8         java/io/PrintStream
#27 = Utf8         println
#28 = Utf8         (Ljava/lang/String;)V
...
```

```
public static void main(java.lang.String[]);
  flags: ACC_PUBLIC, ACC_STATIC
  Code:
    stack=2, locals=1, args_size=1
     0: getstatic   #2          // Field java/lang/System.out:Ljava/io/PrintStream;
     3: ldc         #3          // String Hello, World
     5: invokevirtual #4          // Method java/io/PrintStream.println:(Ljava/lang/String;)V
     8: return
```

ldc at offset 3 takes a pointer to the “Hello, World” string in the constant pool and pushes in the stack.

It’s called a *reference* in the Java world, but it’s rather a pointer, or an address

<sup>8</sup>.

The familiar `invokevirtual` instruction takes the information about the `println` function (or method) from the constant pool and calls it.

As we may know, there are several `println` methods, one for each data type.

Our case is the version of `println` intended for the *String* data type.

But what about the first `getstatic` instruction?

This instruction takes a *reference* (or address of) a field of the object `System.out` and pushes it in the stack.

This value is acts like the *this* pointer for the `println` method.

Thus, internally, the `println` method takes two arguments for input: 1) *this*, i.e., a pointer to an object; 2) the address of the “Hello, World” string.

Indeed, `println()` is called as a method within an initialized `System.out` object.

For convenience, the `javap` utility writes all this information in the comments.

### 4.1.6 Calling `beep()`

This is a simple calling of two functions without arguments:

<sup>8</sup>About difference in pointers and *reference*’s in C++ see: [3.21.3 on page 563](#).

```

public static void main(String[] args)
{
    java.awt.Toolkit.getDefaultToolkit().beep();
};

```

```

public static void main(java.lang.String[]);
  flags: ACC_PUBLIC, ACC_STATIC
  Code:
    stack=1, locals=1, args_size=1
      0: invokestatic #2      // Method java/awt/Toolkit.getDefaultToolkit:()Ljava/awt/Toolkit;
      3: invokevirtual #3      // Method java/awt/Toolkit.beep:()V
      6: return

```

First `invokestatic` at offset 0 calls `java.awt.Toolkit.getDefaultToolkit()`, which returns a reference to an object of class `Toolkit`. The `invokevirtual` instruction at offset 3 calls the `beep()` method of this class.

### 4.1.7 Linear congruential PRNG

Let's try a simple pseudorandom numbers generator, which we already considered once in the book ([1.29 on page 339](#)):

```

public class LCG
{
    public static int rand_state;

    public void my_srand (int init)
    {
        rand_state=init;
    }

    public static int RNG_a=1664525;
    public static int RNG_c=1013904223;

    public int my_rand ()
    {
        rand_state=rand_state*RNG_a;
        rand_state=rand_state+RNG_c;
        return rand_state & 0x7fff;
    }
}

```

There are couple of class fields which are initialized at start. But how? In `javap` output we can find the class constructor:

```

static {};
  flags: ACC_STATIC
  Code:
    stack=1, locals=0, args_size=0
      0: ldc      #5      // int 1664525
      2: putstatic #3      // Field RNG_a:I
      5: ldc      #6      // int 1013904223
      7: putstatic #4      // Field RNG_c:I
     10: return

```

That's the way variables are initialized.

`RNG_a` occupies the 3rd slot in the class and `RNG_c`—4th, and `putstatic` puts the constants there. The `my_srand()` function just stores the input value in `rand_state`:

```

public void my_srand(int);
  flags: ACC_PUBLIC
  Code:
    stack=1, locals=2, args_size=2
     0: iload_1
     1: putstatic    #2          // Field rand_state:I
     4: return

```

iload\_1 takes the input value and pushes it into stack. But why not iload\_0?

It's because this function may use fields of the class, and so *this* is also passed to the function as a zeroth argument.

The field rand\_state occupies the 2nd slot in the class, so putstatic copies the value from the TOS into the 2nd slot.

Now my\_rand():

```

public int my_rand();
  flags: ACC_PUBLIC
  Code:
    stack=2, locals=1, args_size=1
     0: getstatic    #2          // Field rand_state:I
     3: getstatic    #3          // Field RNG_a:I
     6: imul
     7: putstatic    #2          // Field rand_state:I
    10: getstatic    #2          // Field rand_state:I
    13: getstatic    #4          // Field RNG_c:I
    16: iadd
    17: putstatic    #2          // Field rand_state:I
    20: getstatic    #2          // Field rand_state:I
    23: sipush      32767
    26: iand
    27: ireturn

```

It just loads all the values from the object's fields, does the operations and updates rand\_state's value using the putstatic instruction.

At offset 20, rand\_state is reloaded again (because it has been dropped from the stack before, by putstatic).

This looks like non-efficient code, but be sure, the JVM is usually good enough to optimize such things really well.

### 4.1.8 Conditional jumps

Now let's proceed to conditional jumps.

```

public class abs
{
    public static int abs(int a)
    {
        if (a<0)
            return -a;
        return a;
    }
}

```

```

public static int abs(int);
  flags: ACC_PUBLIC, ACC_STATIC
  Code:
    stack=1, locals=1, args_size=1
     0: iload_0
     1: ifge         7

```

```
4: iload_0
5: ineg
6: ireturn
7: iload_0
8: ireturn
```

ifge jumps to offset 7 if the value at **TOS** is greater or equal to 0.

Don't forget, any ifXX instruction pops the value (to be compared) from the stack.

ineg just negates value at **TOS**.

Another example:

```
public static int min (int a, int b)
{
    if (a>b)
        return b;
    return a;
}
```

We get:

```
public static int min(int, int);
flags: ACC_PUBLIC, ACC_STATIC
Code:
  stack=2, locals=2, args_size=2
  0: iload_0
  1: iload_1
  2: if_icmple    7
  5: iload_1
  6: ireturn
  7: iload_0
  8: ireturn
```

if\_icmple pops two values and compares them. If the second one is lesser than (or equal to) the first, a jump to offset 7 is performed.

When we define max() function ...

```
public static int max (int a, int b)
{
    if (a>b)
        return a;
    return b;
}
```

...the resulting code is the same, but the last two iload instructions (at offsets 5 and 7) are swapped:

```
public static int max(int, int);
flags: ACC_PUBLIC, ACC_STATIC
Code:
  stack=2, locals=2, args_size=2
  0: iload_0
  1: iload_1
  2: if_icmple    7
  5: iload_0
  6: ireturn
  7: iload_1
  8: ireturn
```

A more advanced example:

```

public class cond
{
    public static void f(int i)
    {
        if (i<100)
            System.out.print("<100");
        if (i==100)
            System.out.print("==100");
        if (i>100)
            System.out.print(">100");
        if (i==0)
            System.out.print("==0");
    }
}

```

```

public static void f(int);
flags: ACC_PUBLIC, ACC_STATIC
Code:
    stack=2, locals=1, args_size=1
     0: iload_0
     1: bipush      100
     3: if_icmpge   14
     6: getstatic   #2          // Field java/lang/System.out:Ljava/io/PrintStream;
     9: ldc         #3          // String <100
    11: invokevirtual #4          // Method java/io/PrintStream.print:(Ljava/lang/String;)V
    14: iload_0
    15: bipush      100
    17: if_icmpne   28
    20: getstatic   #2          // Field java/lang/System.out:Ljava/io/PrintStream;
    23: ldc         #5          // String ==100
    25: invokevirtual #4          // Method java/io/PrintStream.print:(Ljava/lang/String;)V
    28: iload_0
    29: bipush      100
    31: if_icmple   42
    34: getstatic   #2          // Field java/lang/System.out:Ljava/io/PrintStream;
    37: ldc         #6          // String >100
    39: invokevirtual #4          // Method java/io/PrintStream.print:(Ljava/lang/String;)V
    42: iload_0
    43: ifne        54
    46: getstatic   #2          // Field java/lang/System.out:Ljava/io/PrintStream;
    49: ldc         #7          // String ==0
    51: invokevirtual #4          // Method java/io/PrintStream.print:(Ljava/lang/String;)V
    54: return

```

if\_icmpge pops two values and compares them. If the second one is larger or equal than the first, a jump to offset 14 is performed.

if\_icmpne and if\_icmple work just the same, but implement different conditions.

There is also a ifne instruction at offset 43.

Its name is misnomer, it would've be better to name it ifnz (jump if the value at [TOS](#) is not zero).

And that is what it does: it jumps to offset 54 if the input value is not zero.

If zero, the execution flow proceeds to offset 46, where the "==" string is printed.

N.B.: [JVM](#) has no unsigned data types, so the comparison instructions operate only on signed integer values.

### 4.1.9 Passing arguments

Let's extend our min()/max() example:

```

public class minmax
{
    public static int min (int a, int b)

```

```

    {
        if (a>b)
            return b;
        return a;
    }

public static int max (int a, int b)
{
    if (a>b)
        return a;
    return b;
}

public static void main(String[] args)
{
    int a=123, b=456;
    int max_value=max(a, b);
    int min_value=min(a, b);
    System.out.println(min_value);
    System.out.println(max_value);
}
}

```

Here is main() function code:

```

public static void main(java.lang.String[]);
  flags: ACC_PUBLIC, ACC_STATIC
  Code:
    stack=2, locals=5, args_size=1
     0: bipush      123
     2: istore_1
     3: sipush      456
     6: istore_2
     7: iload_1
     8: iload_2
     9: invokestatic #2      // Method max:(II)I
    12: istore_3
    13: iload_1
    14: iload_2
    15: invokestatic #3      // Method min:(II)I
    18: istore      4
    20: getstatic   #4      // Field java/lang/System.out:Ljava/io/PrintStream;
    23: iload      4
    25: invokevirtual #5      // Method java/io/PrintStream.println:(I)V
    28: getstatic   #4      // Field java/lang/System.out:Ljava/io/PrintStream;
    31: iload_3
    32: invokevirtual #5      // Method java/io/PrintStream.println:(I)V
    35: return

```

Arguments are passed to the other function in the stack, and the return value is left on [TOS](#).

#### 4.1.10 Bitfields

All bit-wise operations work just like in any other [ISA](#):

```

public static int set (int a, int b)
{
    return a | 1<<b;
}

public static int clear (int a, int b)
{
    return a & ~(1<<b));
}

```

```

public static int set(int, int);
  flags: ACC_PUBLIC, ACC_STATIC
  Code:
    stack=3, locals=2, args_size=2
      0: iload_0
      1: iconst_1
      2: iload_1
      3: ishl
      4: ior
      5: ireturn

public static int clear(int, int);
  flags: ACC_PUBLIC, ACC_STATIC
  Code:
    stack=3, locals=2, args_size=2
      0: iload_0
      1: iconst_1
      2: iload_1
      3: ishl
      4: iconst_m1
      5: ixor
      6: iand
      7: ireturn

```

`iconst_m1` loads `-1` in the stack, it's the same as the `0xFFFFFFFF` number.

XORing with `0xFFFFFFFF` has the same effect of inverting all bits ( [2.6 on page 461](#)).

Let's extend all data types to 64-bit *long*:

```

public static long lset (long a, int b)
{
    return a | 1<<b;
}

public static long lclear (long a, int b)
{
    return a & ~(1<<b);
}

```

```

public static long lset(long, int);
  flags: ACC_PUBLIC, ACC_STATIC
  Code:
    stack=4, locals=3, args_size=2
      0: lload_0
      1: iconst_1
      2: iload_2
      3: ishl
      4: i2l
      5: lor
      6: lreturn

public static long lclear(long, int);
  flags: ACC_PUBLIC, ACC_STATIC
  Code:
    stack=4, locals=3, args_size=2
      0: lload_0
      1: iconst_1
      2: iload_2
      3: ishl
      4: iconst_m1
      5: ixor
      6: i2l
      7: land
      8: lreturn

```

The code is the same, but instructions with *l* prefix are used, which operate on 64-bit values.

Also, the second argument type of the function is still *int*, and when the 32-bit value in it needs to be promoted to 64-bit value the *i2l* instruction is used, which essentially extend the value of an *integer* type to a *long* one.

#### 4.1.11 Loops

```
public class Loop
{
    public static void main(String[] args)
    {
        for (int i = 1; i <= 10; i++)
        {
            System.out.println(i);
        }
    }
}
```

```
public static void main(java.lang.String[]);
  flags: ACC_PUBLIC, ACC_STATIC
  Code:
    stack=2, locals=2, args_size=1
     0: iconst_1
     1: istore_1
     2: iload_1
     3: bipush      10
     5: if_icmpgt   21
     8: getstatic   #2          // Field java/lang/System.out:Ljava/io/PrintStream;
    11: iload_1
    12: invokevirtual #3          // Method java/io/PrintStream.println:(I)V
    15: iinc        1, 1
    18: goto        2
    21: return
```

*iconst\_1* loads 1 into [TOS](#), *istore\_1* stores it in the [LVA](#) at slot 1.

Why not the zeroth slot? Because the *main()* function has one argument (array of *String*) and a pointer to it (*or reference*) is now in the zeroth slot.

So, the *i* local variable will always be in 1st slot.

Instructions at offsets 3 and 5 compare *i* with 10.

If *i* is larger, execution flow passes to offset 21, where the function ends.

If it's not, *println* is called.

*i* is then reloaded at offset 11, for *println*.

By the way, we call the *println* method for an *integer*, and we see this in the comments: "(I)V" (*I* means *integer* and *V* means the return type is *void*).

When *println* finishes, *i* is incremented at offset 15.

The first operand of the instruction is the number of a slot (1), the second is the number (1) to add to the variable.

*goto* is just GOTO, it jumps to the beginning of the loop's body offset 2.

Let's proceed with a more complex example:

```
public class Fibonacci
{
    public static void main(String[] args)
    {
        int limit = 20, f = 0, g = 1;

        for (int i = 1; i <= limit; i++)
```



```

        {
            f = f + g;
            g = f - g;
            System.out.println(f);
        }
    }
}

```

```

public static void main(java.lang.String[]);
  flags: ACC_PUBLIC, ACC_STATIC
  Code:
    stack=2, locals=5, args_size=1
     0: bipush      20
     2: istore_1
     3: iconst_0
     4: istore_2
     5: iconst_1
     6: istore_3
     7: iconst_1
     8: istore      4
    10: iload      4
    12: iload_1
    13: if_icmpgt  37
    16: iload_2
    17: iload_3
    18: iadd
    19: istore_2
    20: iload_2
    21: iload_3
    22: isub
    23: istore_3
    24: getstatic  #2          // Field java/lang/System.out:Ljava/io/PrintStream;
    27: iload_2
    28: invokevirtual #3      // Method java/io/PrintStream.println:(I)V
    31: iinc      4, 1
    34: goto      10
    37: return

```

Here is a map of the [LVA](#) slots:

- 0 — the sole argument of `main()`
- 1 — *limit*, always contains 20
- 2 — *f*
- 3 — *g*
- 4 — *i*

We can see that the Java compiler allocates variables in [LVA](#) slots in the same order they were declared in the source code.

There are separate `istore` instructions for accessing slots 0, 1, 2 and 3, but not for 4 and larger, so there is `istore` with an additional operand at offset 8 which takes the slot number as an operand.

It's the same with `iload` at offset 10.

But isn't it dubious to allocate another slot for the *limit* variable, which always contains 20 (so it's a constant in essence), and reload its value so often?

[JVM JIT](#) compiler is usually good enough to optimize such things.

Manual intervention in the code is probably not worth it.

#### 4.1.12 `switch()`

The `switch()` statement is implemented with the `tableswitch` instruction:

```

public static void f(int a)
{
    switch (a)
    {
        case 0: System.out.println("zero"); break;
        case 1: System.out.println("one\n"); break;
        case 2: System.out.println("two\n"); break;
        case 3: System.out.println("three\n"); break;
        case 4: System.out.println("four\n"); break;
        default: System.out.println("something unknown\n"); break;
    };
}

```

As simple, as possible:

```

public static void f(int);
  flags: ACC_PUBLIC, ACC_STATIC
  Code:
    stack=2, locals=1, args_size=1
     0: iload_0
     1: tableswitch { // 0 to 4
                0: 36
                1: 47
                2: 58
                3: 69
                4: 80
                default: 91
            }
    36: getstatic    #2      // Field java/lang/System.out:Ljava/io/PrintStream;
    39: ldc          #3      // String zero
    41: invokevirtual #4      // Method java/io/PrintStream.println:(Ljava/lang/String;)V
    44: goto        99
    47: getstatic    #2      // Field java/lang/System.out:Ljava/io/PrintStream;
    50: ldc          #5      // String one\n
    52: invokevirtual #4      // Method java/io/PrintStream.println:(Ljava/lang/String;)V
    55: goto        99
    58: getstatic    #2      // Field java/lang/System.out:Ljava/io/PrintStream;
    61: ldc          #6      // String two\n
    63: invokevirtual #4      // Method java/io/PrintStream.println:(Ljava/lang/String;)V
    66: goto        99
    69: getstatic    #2      // Field java/lang/System.out:Ljava/io/PrintStream;
    72: ldc          #7      // String three\n
    74: invokevirtual #4      // Method java/io/PrintStream.println:(Ljava/lang/String;)V
    77: goto        99
    80: getstatic    #2      // Field java/lang/System.out:Ljava/io/PrintStream;
    83: ldc          #8      // String four\n
    85: invokevirtual #4      // Method java/io/PrintStream.println:(Ljava/lang/String;)V
    88: goto        99
    91: getstatic    #2      // Field java/lang/System.out:Ljava/io/PrintStream;
    94: ldc          #9      // String something unknown\n
    96: invokevirtual #4      // Method java/io/PrintStream.println:(Ljava/lang/String;)V
    99: return

```

### 4.1.13 Arrays

#### Simple example

Let's first create an array of 10 integers and fill it:

```

public static void main(String[] args)
{
    int a[]=new int[10];
    for (int i=0; i<10; i++)
        a[i]=i;
    dump (a);
}

```

```
}
```

```
public static void main(java.lang.String[]);
  flags: ACC_PUBLIC, ACC_STATIC
  Code:
    stack=3, locals=3, args_size=1
     0: bipush      10
     2: newarray    int
     4: astore_1
     5: iconst_0
     6: istore_2
     7: iload_2
     8: bipush      10
    10: if_icmpge   23
    13: aload_1
    14: iload_2
    15: iload_2
    16: iastore
    17: iinc        2, 1
    20: goto        7
    23: aload_1
    24: invokestatic #4      // Method dump:([I)V
    27: return
```

The newarray instruction creates an array object of 10 *int* elements.

The array's size is set with bipush and left at [TOS](#).

The array's type is set in newarray instruction's operand.

After newarray's execution, a *reference* (or pointer) to the newly created array in the heap is left at the [TOS](#).

astore\_1 stores the *reference* to the 1st slot in [LVA](#).

The second part of the main() function is the loop which stores *i* into the corresponding array element.

aload\_1 gets a *reference* of the array and places it in the stack.

iastore then stores the integer value from the stack in the array, *reference* of which is currently in [TOS](#).

The third part of the main() function calls the dump() function.

An argument for it is prepared by aload\_1 (offset 23).

Now let's proceed to the dump() function:

```
public static void dump(int a[])
{
    for (int i=0; i<a.length; i++)
        System.out.println(a[i]);
}
```

```
public static void dump(int[]);
  flags: ACC_PUBLIC, ACC_STATIC
  Code:
    stack=3, locals=2, args_size=1
     0: iconst_0
     1: istore_1
     2: iload_1
     3: aload_0
     4: arraylength
     5: if_icmpge   23
     8: getstatic   #2      // Field java/lang/System.out:Ljava/io/PrintStream;
    11: aload_0
    12: iload_1
    13: iaload
    14: invokevirtual #3      // Method java/io/PrintStream.println:(I)V
```

```

17: iinc      1, 1
20: goto     2
23: return

```

The incoming reference to the array is in the zeroth slot.

The `a.length` expression in the source code is converted to an `arraylength` instruction: it takes a *reference* to the array and leaves the array size at `TOS`.

`iaload` at offset 13 is used to load array elements, it requires an array *reference* to be present in the stack (prepared by `aload_0` at 11), and also an index (prepared by `iload_1` at offset 12).

Needless to say, instructions prefixed with `a` may be mistakenly comprehended as *array* instructions.

It's not correct. These instructions works with *references* to objects.

And arrays and strings are objects too.

### Summing elements of array

Another example:

```

public class ArraySum
{
    public static int f (int[] a)
    {
        int sum=0;
        for (int i=0; i<a.length; i++)
            sum=sum+a[i];
        return sum;
    }
}

```

```

public static int f(int[]);
flags: ACC_PUBLIC, ACC_STATIC
Code:
  stack=3, locals=3, args_size=1
   0: iconst_0
   1: istore_1
   2: iconst_0
   3: istore_2
   4: iload_2
   5: aload_0
   6: arraylength
   7: if_icmpge    22
  10: iload_1
  11: aload_0
  12: iload_2
  13: iaload
  14: iadd
  15: istore_1
  16: iinc      2, 1
  19: goto     4
  22: iload_1
  23: ireturn

```

`LVA` slot 0 contains a *reference* to the input array.

`LVA` slot 1 contains the local variable `sum`.

### The only argument of the `main()` function is an array too

We'll be using the only argument of the `main()` function, which is an array of strings:

```

public class UseArgument
{
    public static void main(String[] args)
    {
        System.out.print("Hi, ");
        System.out.print(args[1]);
        System.out.println(". How are you?");
    }
}

```

The zeroth argument is the program's name (like in C/C++, etc.), so the 1st argument supplied by the user is 1st.

```

public static void main(java.lang.String[]);
  flags: ACC_PUBLIC, ACC_STATIC
  Code:
    stack=3, locals=1, args_size=1
     0: getstatic    #2      // Field java/lang/System.out:Ljava/io/PrintStream;
     3: ldc          #3      // String Hi,
     5: invokevirtual #4      // Method java/io/PrintStream.print:(Ljava/lang/String;)V
     8: getstatic    #2      // Field java/lang/System.out:Ljava/io/PrintStream;
    11: aload_0
    12: iconst_1
    13: aaload
    14: invokevirtual #4      // Method java/io/PrintStream.print:(Ljava/lang/String;)V
    17: getstatic    #2      // Field java/lang/System.out:Ljava/io/PrintStream;
    20: ldc          #5      // String . How are you?
    22: invokevirtual #6      // Method java/io/PrintStream.println:(Ljava/lang/String;)V
    25: return

```

aload\_0 at 11 loads a *reference* of the zeroth [LVA](#) slot (1st and only main() argument).

iconst\_1 and aaload at 12 and 13 take a *reference* to the first (counting at 0) element of array.

The *reference* to the string object is at [TOS](#) at offset 14, and it is taken from there by println method.

### Pre-initialized array of strings

```

class Month
{
    public static String[] months =
    {
        "January",
        "February",
        "March",
        "April",
        "May",
        "June",
        "July",
        "August",
        "September",
        "October",
        "November",
        "December"
    };

    public String get_month (int i)
    {
        return months[i];
    };
}

```

The get\_month() function is simple:

```

public java.lang.String get_month(int);
  flags: ACC_PUBLIC
  Code:
    stack=2, locals=2, args_size=2
     0: getstatic    #2          // Field months:[Ljava/lang/String;
     3: iload_1
     4: aaload
     5: areturn

```

aaload operates on an array of *references*.

Java String are objects, so the *a*-instructions are used to operate on them.

areturn returns a *reference* to a String object.

How is the months[] array initialized?

```

static {};
  flags: ACC_STATIC
  Code:
    stack=4, locals=0, args_size=0
     0: bipush        12
     2: anewarray     #3          // class java/lang/String
     5: dup
     6: iconst_0
     7: ldc          #4          // String January
     9: aastore
    10: dup
    11: iconst_1
    12: ldc          #5          // String February
    14: aastore
    15: dup
    16: iconst_2
    17: ldc          #6          // String March
    19: aastore
    20: dup
    21: iconst_3
    22: ldc          #7          // String April
    24: aastore
    25: dup
    26: iconst_4
    27: ldc          #8          // String May
    29: aastore
    30: dup
    31: iconst_5
    32: ldc          #9          // String June
    34: aastore
    35: dup
    36: bipush        6
    38: ldc          #10         // String July
    40: aastore
    41: dup
    42: bipush        7
    44: ldc          #11         // String August
    46: aastore
    47: dup
    48: bipush        8
    50: ldc          #12         // String September
    52: aastore
    53: dup
    54: bipush        9
    56: ldc          #13         // String October
    58: aastore
    59: dup
    60: bipush       10
    62: ldc          #14         // String November
    64: aastore
    65: dup
    66: bipush       11

```

```

68: ldc          #15          // String December
70: aastore
71: putstatic    #2           // Field months:[Ljava/lang/String;
74: return

```

anewarray creates a new array of *references* (hence a prefix).

The object's type is defined in the anewarray's operand, it is the "java/lang/String" string.

The bipush 12 before anewarray sets the array's size.

We see here a new instruction for us: dup.

It's a standard instruction in stack computers (including the Forth programming language) which just duplicates the value at TOS.

By the way, FPU 80x87 is also a stack computer and it has similar instruction - FDUP.

It is used here to duplicate a *reference* to an array, because the aastore instruction pops the *reference* to array from the stack, but subsequent aastore will need it again.

The Java compiler concluded that it's better to generate a dup instead of generating a getstatic instruction before each array store operation (i.e., 11 times).

aastore puts a *reference* (to string) into the array at an index which is taken from TOS.

Finally, putstatic puts *reference* to the newly created array into the second field of our object, i.e., *months* field.

## Variadic functions

Variadic functions actually use arrays:

```

public static void f(int... values)
{
    for (int i=0; i<values.length; i++)
        System.out.println(values[i]);
}

public static void main(String[] args)
{
    f (1,2,3,4,5);
}

```

```

public static void f(int...);
flags: ACC_PUBLIC, ACC_STATIC, ACC_VARARGS
Code:
    stack=3, locals=2, args_size=1
     0: iconst_0
     1: istore_1
     2: iload_1
     3: aload_0
     4: arraylength
     5: if_icmpge    23
     8: getstatic    #2           // Field java/lang/System.out:Ljava/io/PrintStream;
    11: aload_0
    12: iload_1
    13: iaload
    14: invokevirtual #3           // Method java/io/PrintStream.println:(I)V
    17: iinc         1, 1
    20: goto        2
    23: return

```

f() just takes an array of integers using aload\_0 at offset 3.

Then it gets the array's size, etc.

```

public static void main(java.lang.String[]);
  flags: ACC_PUBLIC, ACC_STATIC
  Code:
    stack=4, locals=1, args_size=1
     0: iconst_5
     1: newarray      int
     3: dup
     4: iconst_0
     5: iconst_1
     6: iastore
     7: dup
     8: iconst_1
     9: iconst_2
    10: iastore
    11: dup
    12: iconst_2
    13: iconst_3
    14: iastore
    15: dup
    16: iconst_3
    17: iconst_4
    18: iastore
    19: dup
    20: iconst_4
    21: iconst_5
    22: iastore
    23: invokestatic #4      // Method f:([I)V
    26: return

```

The array is constructed in main() using the newarray instruction, then it's filled, and f() is called.

Oh, by the way, array object is not destroyed at the end of main().

There are no destructors in Java at all, because the JVM has a garbage collector which does this automatically, when it feels it needs to.

What about the format() method?

It takes two arguments at input: a string and an array of objects:

```
public PrintStream format(String format, Object... args)
```

( <http://docs.oracle.com/javase/tutorial/java/data/numberformat.html> )

Let's see:

```

public static void main(String[] args)
{
    int i=123;
    double d=123.456;
    System.out.format("int: %d double: %f.%n", i, d);
}

```

```

public static void main(java.lang.String[]);
  flags: ACC_PUBLIC, ACC_STATIC
  Code:
    stack=7, locals=4, args_size=1
     0: bipush      123
     2: istore_1
     3: ldc2_w      #2      // double 123.456d
     6: dstore_2
     7: getstatic   #4      // Field java/lang/System.out:Ljava/io/PrintStream;
    10: ldc        #5      // String int: %d double: %f.%n
    12: iconst_2
    13: anewarray   #6      // class java/lang/Object

```



```

16: dup
17: iconst_0
18: iload_1
19: invokestatic #7          // Method java/lang/Integer.valueOf:(I)Ljava/lang/Integer;
22: astore
23: dup
24: iconst_1
25: dload_2
26: invokestatic #8          // Method java/lang/Double.valueOf:(D)Ljava/lang/Double;
29: astore
30: invokevirtual #9         // Method java/io/PrintStream.format:(Ljava/lang/String;[L
↵ Ljava/lang/Object;)Ljava/io/PrintStream;
33: pop
34: return

```

So values of the *int* and *double* types are first promoted to Integer and Double objects using the `valueOf` methods.

The `format()` method needs objects of type `Object` at input, and since the `Integer` and `Double` classes are derived from the root `Object` class, they suitable for elements in the input array.

On the other hand, an array is always homogeneous, i.e., it can't hold elements of different types, which makes it impossible to push *int* and *double* values in it.

An array of `Object` objects is created at offset 13, an `Integer` object is added to the array at offset 22, and a `Double` object is added to the array at offset 29.

The penultimate `pop` instruction discards the element at `TOS`, so when `return` is executed, the stack becomes empty (or balanced).

## Two-dimensional arrays

Two-dimensional arrays in Java are just one-dimensional arrays of *references* to another one-dimensional arrays.

Let's create a two-dimensional array:

```

public static void main(String[] args)
{
    int[][] a = new int[5][10];
    a[1][2]=3;
}

```

```

public static void main(java.lang.String[]);
flags: ACC_PUBLIC, ACC_STATIC
Code:
    stack=3, locals=2, args_size=1
     0: iconst_5
     1: bipush      10
     3: multianewarray #2, 2    // class "[[I"
     7: astore_1
     8: aload_1
     9: iconst_1
    10: aaload
    11: iconst_2
    12: iconst_3
    13: iastore
    14: return

```

It's created using the `multianewarray` instruction: the object's type and dimensionality are passed as operands.

The array's size (10\*5) is left in stack (using the instructions `iconst_5` and `bipush`).

A *reference* to row #1 is loaded at offset 10 (`iconst_1` and `aaload`).

The column is chosen using `iconst_2` at offset 11.

The value to be written is set at offset 12.

iastore at 13 writes the array's element.

How it is an element accessed?

```
public static int get12 (int[][] in)
{
    return in[1][2];
}
```

```
public static int get12(int[][]);
flags: ACC_PUBLIC, ACC_STATIC
Code:
  stack=2, locals=1, args_size=1
   0: aload_0
   1: iconst_1
   2: aaload
   3: iconst_2
   4: iaload
   5: ireturn
```

A *Reference* to the array's row is loaded at offset 2, the column is set at offset 3, then iaload loads the array's element.

### Three-dimensional arrays

Three-dimensional arrays are just one-dimensional arrays of *references* to one-dimensional arrays of *references* to one-dimensional arrays.

```
public static void main(String[] args)
{
    int[][][] a = new int[5][10][15];

    a[1][2][3]=4;

    get_elem(a);
}
```

```
public static void main(java.lang.String[]);
flags: ACC_PUBLIC, ACC_STATIC
Code:
  stack=3, locals=2, args_size=1
   0: iconst_5
   1: bipush      10
   3: bipush      15
   5: multianewarray #2, 3    // class "[[[I"
   9: astore_1
  10: aload_1
  11: iconst_1
  12: aaload
  13: iconst_2
  14: aaload
  15: iconst_3
  16: iconst_4
  17: iastore
  18: aload_1
  19: invokestatic #3        // Method get_elem:([[[I)I
  22: pop
  23: return
```

Now it takes two aaload instructions to find right *reference*:

```

public static int get_elem (int[][][] a)
{
    return a[1][2][3];
}

```

```

public static int get_elem(int[][][]);
flags: ACC_PUBLIC, ACC_STATIC
Code:
  stack=2, locals=1, args_size=1
   0: aload_0
   1: iconst_1
   2: aaload
   3: iconst_2
   4: aaload
   5: iconst_3
   6: iaload
   7: ireturn

```

## Summary

Is it possible to do a buffer overflow in Java?

No, because the array's length is always present in an array object, array bounds are controlled, and an exception is to be raised in case of out-of-bounds access.

There are no multi-dimensional arrays in Java in the C/C++ sense, so Java is not very suited for fast scientific computations.

### 4.1.14 Strings

#### First example

Strings are objects and are constructed in the same way as other objects (and arrays).

```

public static void main(String[] args)
{
    System.out.println("What is your name?");
    String input = System.console().readLine();
    System.out.println("Hello, "+input);
}

```

```

public static void main(java.lang.String[]);
flags: ACC_PUBLIC, ACC_STATIC
Code:
  stack=3, locals=2, args_size=1
   0: getstatic    #2          // Field java/lang/System.out:Ljava/io/PrintStream;
   3: ldc          #3          // String What is your name?
   5: invokevirtual #4          // Method java/io/PrintStream.println:(Ljava/lang/String;)V
   8: invokestatic #5          // Method java/lang/System.console:()Ljava/io/Console;
  11: invokevirtual #6          // Method java/io/Console.readLine:()Ljava/lang/String;
  14: astore_1
  15: getstatic    #2          // Field java/lang/System.out:Ljava/io/PrintStream;
  18: new          #7          // class java/lang/StringBuilder
  21: dup
  22: invokespecial #8          // Method java/lang/StringBuilder."<init>":()V
  25: ldc          #9          // String Hello,
  27: invokevirtual #10         // Method java/lang/StringBuilder.append:(Ljava/lang/String;
↳ ;)Ljava/lang/StringBuilder;
  30: aload_1
  31: invokevirtual #10         // Method java/lang/StringBuilder.append:(Ljava/lang/String;
↳ ;)Ljava/lang/StringBuilder;
  34: invokevirtual #11         // Method java/lang/StringBuilder.toString:()Ljava/lang/
↳ String;

```

```
37: invokevirtual #4          // Method java/io/PrintStream.println:(Ljava/lang/String;)V
40: return
```

The `readLine()` method is called at offset 11, a *reference* to string (which is supplied by the user) is then stored at [TOS](#).

At offset 14 the *reference* to string is stored in slot 1 of [LVA](#).

The string the user entered is reloaded at offset 30 and concatenated with the "Hello, " string using the `StringBuilder` class.

The constructed string is then printed using `println` at offset 37.

## Second example

Another example:

```
public class strings
{
    public static char test (String a)
    {
        return a.charAt(3);
    };

    public static String concat (String a, String b)
    {
        return a+b;
    }
}
```

```
public static char test(java.lang.String);
flags: ACC_PUBLIC, ACC_STATIC
Code:
    stack=2, locals=1, args_size=1
     0: aload_0
     1: iconst_3
     2: invokevirtual #2          // Method java/lang/String.charAt:(I)C
     5: ireturn
```

The string concatenation is performed using `StringBuilder`:

```
public static java.lang.String concat(java.lang.String, java.lang.String);
flags: ACC_PUBLIC, ACC_STATIC
Code:
    stack=2, locals=2, args_size=2
     0: new          #3          // class java/lang/StringBuilder
     3: dup
     4: invokespecial #4          // Method java/lang/StringBuilder."<init>":()V
     7: aload_0
     8: invokevirtual #5          // Method java/lang/StringBuilder.append:(Ljava/lang/String;
↳ ;)Ljava/lang/StringBuilder;
    11: aload_1
    12: invokevirtual #5          // Method java/lang/StringBuilder.append:(Ljava/lang/String;
↳ ;)Ljava/lang/StringBuilder;
    15: invokevirtual #6          // Method java/lang/StringBuilder.toString:()Ljava/lang/
↳ String;
    18: areturn
```

Another example:

```
public static void main(String[] args)
{
    String s="Hello!";
```

```

        int n=123;
        System.out.println("s=" + s + " n=" + n);
    }

```

And again, the strings are constructed using the `StringBuilder` class and its `append` method, then the constructed string is passed to `println`:

```

public static void main(java.lang.String[]);
  flags: ACC_PUBLIC, ACC_STATIC
  Code:
    stack=3, locals=3, args_size=1
     0: ldc         #2          // String Hello!
     2: astore_1
     3: bipush      123
     5: istore_2
     6: getstatic   #3          // Field java/lang/System.out:Ljava/io/PrintStream;
     9: new         #4          // class java/lang/StringBuilder
    12: dup
    13: invokespecial #5          // Method java/lang/StringBuilder."<init>":()V
    16: ldc         #6          // String s=
    18: invokevirtual #7          // Method java/lang/StringBuilder.append:(Ljava/lang/String
    ↪ ;)Ljava/lang/StringBuilder;
    21: aload_1
    22: invokevirtual #7          // Method java/lang/StringBuilder.append:(Ljava/lang/String
    ↪ ;)Ljava/lang/StringBuilder;
    25: ldc         #8          // String n=
    27: invokevirtual #7          // Method java/lang/StringBuilder.append:(Ljava/lang/String
    ↪ ;)Ljava/lang/StringBuilder;
    30: iload_2
    31: invokevirtual #9          // Method java/lang/StringBuilder.append:(I)Ljava/lang/
    ↪ StringBuilder;
    34: invokevirtual #10         // Method java/lang/StringBuilder.toString:()Ljava/lang/
    ↪ String;
    37: invokevirtual #11         // Method java/io/PrintStream.println:(Ljava/lang/String;)V
    40: return

```

#### 4.1.15 Exceptions

Let's rework our *Month* example ( [4.1.13 on page 683](#)) a bit:

Listing 4.10: `IncorrectMonthException.java`

```

public class IncorrectMonthException extends Exception
{
    private int index;

    public IncorrectMonthException(int index)
    {
        this.index = index;
    }
    public int getIndex()
    {
        return index;
    }
}

```

Listing 4.11: `Month2.java`

```

class Month2
{
    public static String[] months =
    {
        "January",
        "February",

```

```

        "March",
        "April",
        "May",
        "June",
        "July",
        "August",
        "September",
        "October",
        "November",
        "December"
    };

    public static String get_month (int i) throws IncorrectMonthException
    {
        if (i<0 || i>11)
            throw new IncorrectMonthException(i);
        return months[i];
    };

    public static void main (String[] args)
    {
        try
        {
            System.out.println(get_month(100));
        }
        catch(IncorrectMonthException e)
        {
            System.out.println("incorrect month index: "+ e.getIndex());
            e.printStackTrace();
        }
    };
}

```

Essentially, `IncorrectMonthException.class` has just an object constructor and one getter method.

The `IncorrectMonthException` class is derived from `Exception`, so the `IncorrectMonthException` constructor first calls the constructor of the `Exception` class, then it puts incoming integer value into the sole `IncorrectMonthException` class field:

```

public IncorrectMonthException(int);
  flags: ACC_PUBLIC
  Code:
    stack=2, locals=2, args_size=2
     0: aload_0
     1: invokespecial #1      // Method java/lang/Exception."<init>":()V
     4: aload_0
     5: iload_1
     6: putfield      #2      // Field index:I
     9: return

```

`getIndex()` is just a getter. A *reference* to `IncorrectMonthException` is passed in the zeroth [LVA](#) slot (*this*), `aload_0` takes it, `getfield` loads an integer value from the object, `ireturn` returns it.

```

public int getIndex();
  flags: ACC_PUBLIC
  Code:
    stack=1, locals=1, args_size=1
     0: aload_0
     1: getfield      #2      // Field index:I
     4: ireturn

```

Now let's take a look at `get_month()` in `Month2.class`:

Listing 4.12: `Month2.class`

```

public static java.lang.String get_month(int) throws IncorrectMonthException;
  flags: ACC_PUBLIC, ACC_STATIC
  Code:
    stack=3, locals=1, args_size=1
      0: iload_0
      1: iflt      10
      4: iload_0
      5: bipush    11
      7: if_icmple 19
     10: new        #2          // class IncorrectMonthException
     13: dup
     14: iload_0
     15: invokespecial #3        // Method IncorrectMonthException."<init>":(I)V
     18: athrow
     19: getstatic   #4          // Field months:[Ljava/lang/String;
     22: iload_0
     23: aaload
     24: areturn

```

iflt at offset 1 is *if less than*.

In case of invalid index, a new object is created using the new instruction at offset 10.

The object's type is passed as an operand to the instruction (which is IncorrectMonthException).

Then its constructor is called, and index is passed via **TOS** (offset 15).

When the control flow is offset 18, the object is already constructed, so now the athrow instruction takes a *reference* to the newly constructed object and signals to **JVM** to find the appropriate exception handler.

The athrow instruction doesn't return the control flow here, so at offset 19 there is another **basic block**, not related to exceptions business, where we can get from offset 7.

How do handlers work?

main() in Month2.class:

Listing 4.13: Month2.class

```

public static void main(java.lang.String[]);
  flags: ACC_PUBLIC, ACC_STATIC
  Code:
    stack=3, locals=2, args_size=1
      0: getstatic   #5          // Field java/lang/System.out:Ljava/io/PrintStream;
      3: bipush     100
      5: invokestatic #6          // Method get_month:(I)Ljava/lang/String;
      8: invokevirtual #7         // Method java/io/PrintStream.println:(Ljava/lang/String;)V
     11: goto       47
     14: astore_1
     15: getstatic   #5          // Field java/lang/System.out:Ljava/io/PrintStream;
     18: new         #8          // class java/lang/StringBuilder
     21: dup
     22: invokespecial #9         // Method java/lang/StringBuilder."<init>":()V
     25: ldc         #10         // String incorrect month index:
     27: invokevirtual #11        // Method java/lang/StringBuilder.append:(Ljava/lang/String;
↳ ;)Ljava/lang/StringBuilder;
     30: aload_1
     31: invokevirtual #12        // Method IncorrectMonthException.getIndex:()I
     34: invokevirtual #13        // Method java/lang/StringBuilder.append:(I)Ljava/lang/
↳ StringBuilder;
     37: invokevirtual #14        // Method java/lang/StringBuilder.toString:()Ljava/lang/
↳ String;
     40: invokevirtual #7         // Method java/io/PrintStream.println:(Ljava/lang/String;)V
     43: aload_1
     44: invokevirtual #15        // Method IncorrectMonthException.printStackTrace:()V
     47: return
  Exception table:
    from   to  target type
      0    11   14   Class IncorrectMonthException

```

Here is the Exception table, which defines that from offsets 0 to 11 (inclusive) an exception `IncorrectMonthException` may happen, and if it does, the control flow is to be passed to offset 14.

Indeed, the main program ends at offset 11.

At offset 14 the handler starts. It's not possible to get here, there are no conditional/unconditional jumps to this area.

But `JVM` will transfer the execution flow here in case of an exception.

The very first `astore_1` (at 14) takes the incoming *reference* to the exception object and stores it in `LVA` slot 1.

Later, the `getIndex()` method (of this exception object) will be called at offset 31.

The *reference* to the current exception object is passed right before that (offset 30).

The rest of the code is does just string manipulation: first the integer value returned by `getIndex()` is converted to string by the `toString()` method, then it's concatenated with the "incorrect month index: " text string (like we saw before), then `println()` and `printStackTrace()` are called.

After `printStackTrace()` finishes, the exception is handled and we can continue with the normal execution.

At offset 47 there is a return which finishes the `main()` function, but there could be any other code which would execute as if no exceptions were raised.

Here is an example on how IDA shows exception ranges:

Listing 4.14: from some random .class file found on the author's computer

```
.catch java/io/FileNotFoundException from met001_335 to met001_360\
using met001_360
.catch java/io/FileNotFoundException from met001_185 to met001_214\
using met001_214
.catch java/io/FileNotFoundException from met001_181 to met001_192\
using met001_195
.catch java/io/FileNotFoundException from met001_155 to met001_176\
using met001_176
.catch java/io/FileNotFoundException from met001_83 to met001_129 using \
met001_129
.catch java/io/FileNotFoundException from met001_42 to met001_66 using \
met001_69
.catch java/io/FileNotFoundException from met001_begin to met001_37\
using met001_37
```

## 4.1.16 Classes

Simple class:

Listing 4.15: test.java

```
public class test
{
    public static int a;
    private static int b;

    public test()
    {
        a=0;
        b=0;
    }
    public static void set_a (int input)
    {
        a=input;
    }
    public static int get_a ()
    {
        return a;
    }
}
```



```

    public static void set_b (int input)
    {
        b=input;
    }
    public static int get_b ()
    {
        return b;
    }
}

```

The constructor just sets both fields to zero:

```

public test();
flags: ACC_PUBLIC
Code:
    stack=1, locals=1, args_size=1
    0: aload_0
    1: invokespecial #1      // Method java/lang/Object."<init>":()V
    4: iconst_0
    5: putstatic     #2      // Field a:I
    8: iconst_0
    9: putstatic     #3      // Field b:I
   12: return

```

Setter of a:

```

public static void set_a(int);
flags: ACC_PUBLIC, ACC_STATIC
Code:
    stack=1, locals=1, args_size=1
    0: iload_0
    1: putstatic     #2      // Field a:I
    4: return

```

Getter of a:

```

public static int get_a();
flags: ACC_PUBLIC, ACC_STATIC
Code:
    stack=1, locals=0, args_size=0
    0: getstatic     #2      // Field a:I
    3: ireturn

```

Setter of b:

```

public static void set_b(int);
flags: ACC_PUBLIC, ACC_STATIC
Code:
    stack=1, locals=1, args_size=1
    0: iload_0
    1: putstatic     #3      // Field b:I
    4: return

```

Getter of b:

```

public static int get_b();
flags: ACC_PUBLIC, ACC_STATIC
Code:
    stack=1, locals=0, args_size=0
    0: getstatic     #3      // Field b:I
    3: ireturn

```

There is no difference in the code which works with public and private fields.

But this type information is present in the .class file, and it's not possible to access private fields from everywhere.

Let's create an object and call its method:

Listing 4.16: ex1.java

```
public class ex1
{
    public static void main(String[] args)
    {
        test obj=new test();
        obj.set_a (1234);
        System.out.println(obj.a);
    }
}
```

```
public static void main(java.lang.String[]);
flags: ACC_PUBLIC, ACC_STATIC
Code:
    stack=2, locals=2, args_size=1
     0: new          #2          // class test
     3: dup
     4: invokespecial #3          // Method test.<init>:()V
     7: astore_1
     8: aload_1
     9: pop
    10: sipush       1234
    13: invokestatic #4          // Method test.set_a:(I)V
    16: getstatic   #5          // Field java/lang/System.out:Ljava/io/PrintStream;
    19: aload_1
    20: pop
    21: getstatic   #6          // Field test.a:I
    24: invokevirtual #7          // Method java/io/PrintStream.println:(I)V
    27: return
```

The new instruction creates an object, but doesn't call the constructor (it is called at offset 4).

The set\_a() method is called at offset 16.

The a field is accessed using the getstatic instruction at offset 21.

### 4.1.17 Simple patching

#### First example

Let's proceed with a simple code patching task.

```
public class nag
{
    public static void nag_screen()
    {
        System.out.println("This program is not registered");
    };
    public static void main(String[] args)
    {
        System.out.println("Greetings from the mega-software");
        nag_screen();
    }
}
```

How would we remove the printing of "This program is not registered" string?

Let's load the .class file into IDA:

```

; Segment type: Pure code
.method public static nag_screen()V
.limit stack 2
.line 4
178 000 002 |   getstatic java/lang/System.out Ljava/io/PrintStream; ; CODE XREF: main+8↓P
018 003     |   ldc "This program is not registered"
182 000 004   invokevirtual java/io/PrintStream.println(Ljava/lang/String;)V
.line 5
177     |   return
??? ??? ???+ .end method
??? ??? ???+
???
; -----

; Segment type: Pure code
.method public static main([Ljava/lang/String;)V
.limit stack 2
.limit locals 1
.line 8
178 000 002   getstatic java/lang/System.out Ljava/io/PrintStream;
018 005     |   ldc "Greetings from the mega-software"
182 000 004   invokevirtual java/io/PrintStream.println(Ljava/lang/String;)V
.line 9
184 000 006   invokestatic nag.nag_screen()V
.line 10
177     |   return

```

Figure 4.1: IDA

Let's patch the first byte of the function to 177 (which is the return instruction's opcode):

```

; Segment type: Pure code
.method public static nag_screen()V
.limit stack 2
.line 4
nag_screen: ; CODE XREF: main+8↓P
177     |   return
000     |   0 ; 0x00
002     |   2 ; 0x02
018 003 |   ldc "This program is not registered"
182 000 004 |   invokevirtual java/io/PrintStream.println(Ljava/lang/String;)V
.line 5
177     |   return
??? ??? ???+ .end method
??? ??? ???+
???
; -----

```

Figure 4.2: IDA

But that doesn't work (JRE 1.7):

```

Exception in thread "main" java.lang.VerifyError: Expecting a stack map frame
Exception Details:
Location:
  nag.nag_screen()V @1: nop
Reason:
  Error exists in the bytecode
Bytecode:
  0000000: b100 0212 03b6 0004 b1

  at java.lang.Class.getDeclaredMethods0(Native Method)
  at java.lang.Class.privateGetDeclaredMethods(Class.java:2615)

```

```

at java.lang.Class.getMethod0(Class.java:2856)
at java.lang.Class.getMethod(Class.java:1668)
at sun.launcher.LauncherHelper.getMainMethod(LauncherHelper.java:494)
at sun.launcher.LauncherHelper.checkAndLoadMain(LauncherHelper.java:486)

```

Perhaps JVM has some other checks related to the stack maps.

OK, let's patch it differently by removing the call to `nag()`:

```

; Segment type: Pure code
.method public static main([Ljava/lang/String;)V
.limit stack 2
.limit locals 1
.line 8
178 000 002   getstatic java/lang/System.out Ljava/io/PrintStream;
018 005     ldc "Greetings from the mega-software"
182 000 004   invokevirtual java/io/PrintStream.println(Ljava/lang/String;)V
.line 9
000         nop
000         nop
000         nop
.line 10
177         return
; =====

```

Figure 4.3: IDA

0 is the opcode for `NOP`.

Now that works!

### Second example

Another simple crackme example:

```

public class password
{
    public static void main(String[] args)
    {
        System.out.println("Please enter the password");
        String input = System.console().readLine();
        if (input.equals("secret"))
            System.out.println("password is correct");
        else
            System.out.println("password is not correct");
    }
}

```

Let's load it in IDA:

```

; Segment type: Pure code
.method public static main([Ljava/lang/String;)V
.limit stack 2
.limit locals 2
.line 3
178 000 002   getstatic java/lang/System.out Ljava/io/PrintStream;
018 003      ldc "Please enter the password"
182 000 004   invokevirtual java/io/PrintStream.println(Ljava/lang/String;)V
.line 4
184 000 005   invokestatic java/lang/System.console()Ljava/io/Console;
182 000 006   invokevirtual java/io/Console.readLine()Ljava/lang/String;
076          astore_1 ; met002_slot001
.line 5
043          aload_1 ; met002_slot001
018 007      ldc "secret"
182 000 008   invokevirtual java/lang/String.equals(Ljava/lang/Object;)Z
153 000 014   ifeq met002_35
.line 6
178 000 002   getstatic java/lang/System.out Ljava/io/PrintStream;
018 009      ldc "password is correct"
182 000 004   invokevirtual java/io/PrintStream.println(Ljava/lang/String;)V
167 000 011   goto met002_43
.line 8

met002_35:                                     ; CODE XREF: main+21↑j
178 000 002   .stack use locals
          locals Object java/lang/String
          .end stack
018 010      getstatic java/lang/System.out Ljava/io/PrintStream;
182 000 004   ldc "password is not correct"
          invokevirtual java/io/PrintStream.println(Ljava/lang/String;)V
.line 9

```

Figure 4.4: IDA

We see here the `ifeq` instruction which does the job.

Its name stands for *if equal*, and this is misnomer, a better name would be `ifz` (*if zero*), i.e, if value at `TOS` is zero, then do the jump.

In our example, it jumps if the password is not correct (the `equals` method returns `False`, which is 0).

The very first idea is to patch this instruction.

There are two bytes in `ifeq` opcode, which encode the jump offset.

To make this instruction a NOP, we must set the 3rd byte to the value of 3 (because by adding 3 to the current address we will always jump to the next instruction, since the `ifeq` instruction's length is 3 bytes):

```

; Segment type: Pure code
.method public static main([Ljava/lang/String;)V
.limit stack 2
.limit locals 2
.line 3
178 000 002   getstatic java/lang/System.out Ljava/io/PrintStream;
018 003     ldc "Please enter the password"
182 000 004   invokevirtual java/io/PrintStream.println(Ljava/lang/String;)V
.line 4
184 000 005   invokestatic java/lang/System.console()Ljava/io/Console;
182 000 006   invokevirtual java/io/Console.readLine()Ljava/lang/String;
076         astore_1 ; met002_slot001
.line 5
043         aload_1 ; met002_slot001
018 007     ldc "secret"
182 000 008   invokevirtual java/lang/String.equals(Ljava/lang/Object;)Z
153 000 003   ifeq met002_24
.line 6
met002_24:                                     ; CODE XREF: main+21↑j
178 000 002   getstatic java/lang/System.out Ljava/io/PrintStream;
018 009     ldc "password is correct"
182 000 004   invokevirtual java/io/PrintStream.println(Ljava/lang/String;)V
167 000 011   goto met002_43
.line 8
178 000 002   .stack use locals
         locals Object java/lang/String
         .end stack
018 010     getstatic java/lang/System.out Ljava/io/PrintStream;
182 000 004   invokevirtual java/io/PrintStream.println(Ljava/lang/String;)V
.line 9

```

Figure 4.5: IDA

That doesn't work (JRE 1.7):

```

Exception in thread "main" java.lang.VerifyError: Expecting a stackmap frame at branch target
↳ 24
Exception Details:
Location:
    password.main([Ljava/lang/String;)V @21: ifeq
Reason:
    Expected stackmap frame at this location.
Bytecode:
    00000000: b200 0212 03b6 0004 b800 05b6 0006 4c2b
    0000010: 1207 b600 0899 0003 b200 0212 09b6 0004
    0000020: a700 0bb2 0002 120a b600 04b1
Stackmap Table:
    append_frame(@35, Object[#20])
    same_frame(@43)

    at java.lang.Class.getDeclaredMethods0(Native Method)
    at java.lang.Class.privateGetDeclaredMethods(Class.java:2615)
    at java.lang.Class.getMethod0(Class.java:2856)
    at java.lang.Class.getMethod(Class.java:1668)
    at sun.launcher.LauncherHelper.getMainMethod(LauncherHelper.java:494)
    at sun.launcher.LauncherHelper.checkAndLoadMain(LauncherHelper.java:486)

```

But it must be mentioned that it worked in JRE 1.6.

We can also try to replace to all 3 ifeq opcode bytes with zero bytes (NOP), and it still won't work.

Seems like there are more stack map checks in JRE 1.7.

OK, we'll replace the whole call to the equals method with the iconst\_1 instruction plus a pack of NOPs:

```

; Segment type: Pure code
.method public static main([Ljava/lang/String;)V
.limit stack 2
.limit locals 2
.line 3
178 000 002   getstatic java/lang/System.out Ljava/io/PrintStream;
018 003     ldc "Please enter the password"
182 000 004   invokevirtual java/io/PrintStream.println(Ljava/lang/String;)V
.line 4
184 000 005   invokestatic java/lang/System.console()Ljava/io/Console;
182 000 006   invokevirtual java/io/Console.readLine()Ljava/lang/String;
076         astore_1 ; met002_slot001
.line 5
004         iconst_1
000         nop
000         nop
000         nop
000         nop
000         nop
000         nop
-- 153 000 014   ifeq met002_35
.line 6
178 000 002   getstatic java/lang/System.out Ljava/io/PrintStream;
018 009     ldc "password is correct"
182 000 004   invokevirtual java/io/PrintStream.println(Ljava/lang/String;)V
167 000 011   goto met002_43
.line 8

met002_35:                                     ; CODE XREF: main+21↑j
178 000 002   .stack use locals
        locals Object java/lang/String
        .end stack

```

Figure 4.6: IDA

1 needs always to be in the TOS when the ifeq instruction is executed, so ifeq would never jump. This works.

#### 4.1.18 Summary

What is missing in Java in comparison to C/C++?

- Structures: use classes.
- Unions: use class hierarchies.
- Unsigned data types. By the way, this makes cryptographic algorithms somewhat harder to implement in Java.
- Function pointers.

## Chapter 5

# Finding important/interesting stuff in the code

Minimalism it is not a prominent feature of modern software.

But not because the programmers are writing a lot, but because a lot of libraries are commonly linked statically to executable files. If all external libraries were shifted into an external DLL files, the world would be different. (Another reason for C++ are the [STL](#) and other template libraries.)

Thus, it is very important to determine the origin of a function, if it is from standard library or well-known library (like Boost<sup>1</sup>, libpng<sup>2</sup>), or if it is related to what we are trying to find in the code.

It is just absurd to rewrite all code in C/C++ to find what we're looking for.

One of the primary tasks of a reverse engineer is to find quickly the code he/she needs, and what is not that important.

The [IDA](#) disassembler allow us to search among text strings, byte sequences and constants. It is even possible to export the code to .lst or .asm text files and then use grep, awk, etc.

When you try to understand what some code is doing, this easily could be some open-source library like libpng. So when you see some constants or text strings which look familiar, it is always worth to *google* them. And if you find the opensource project where they are used, then it's enough just to compare the functions. It may solve some part of the problem.

For example, if a program uses XML files, the first step may be determining which XML library is used for processing, since the standard (or well-known) libraries are usually used instead of self-made one.

For example, the author of these lines once tried to understand how the compression/decompression of network packets works in SAP 6.0. It is a huge software, but a detailed [.PDB](#) with debugging information is present, and that is convenient. He finally came to the idea that one of the functions, that was called *CsDecomprLZC*, was doing the decompression of network packets. Immediately he tried to google its name and he quickly found the function was used in MaxDB (it is an open-source SAP project)<sup>3</sup>.

<http://www.google.com/search?q=CsDecomprLZC>

Astoundingly, MaxDB and SAP 6.0 software shared likewise code for the compression/decompression of network packets.

## 5.1 Identification of executable files

### 5.1.1 Microsoft Visual C++

MSVC versions and DLLs that can be imported:

<sup>1</sup><http://go.yurichev.com/17036>

<sup>2</sup><http://go.yurichev.com/17037>

<sup>3</sup>More about it in relevant section ( [8.12.1 on page 873](#))



Marketing ver.	Internal ver.	CL.EXE ver.	DLLs imported	Release date
6	6.0	12.00	msvcrt.dll msvcp60.dll	June 1998
.NET (2002)	7.0	13.00	msvcr70.dll msvcp70.dll	February 13, 2002
.NET 2003	7.1	13.10	msvcr71.dll msvcp71.dll	April 24, 2003
2005	8.0	14.00	msvcr80.dll msvcp80.dll	November 7, 2005
2008	9.0	15.00	msvcr90.dll msvcp90.dll	November 19, 2007
2010	10.0	16.00	msvcr100.dll msvcp100.dll	April 12, 2010
2012	11.0	17.00	msvcr110.dll msvcp110.dll	September 12, 2012
2013	12.0	18.00	msvcr120.dll msvcp120.dll	October 17, 2013

msvcp\*.dll has C++-related functions, so if it is imported, this is probably a C++ program.

### Name mangling

The names usually start with the ? symbol.

You can read more about MSVC's [name mangling](#) here: [3.21.1 on page 547](#).

### 5.1.2 GCC

Aside from \*NIX targets, GCC is also present in the win32 environment, in the form of Cygwin and MinGW.

### Name mangling

Names usually start with the \_Z symbols.

You can read more about GCC's [name mangling](#) here: [3.21.1 on page 547](#).

### Cygwin

cygwin1.dll is often imported.

### MinGW

msvcrt.dll may be imported.

### 5.1.3 Intel Fortran

libifcoremd.dll, libifportmd.dll and libiomp5md.dll (OpenMP support) may be imported.

libifcoremd.dll has a lot of functions prefixed with for\_, which means *Fortran*.

### 5.1.4 Watcom, OpenWatcom

#### Name mangling

Names usually start with the W symbol.

For example, that is how the method named "method" of the class "class" that does not have any arguments and returns *void* is encoded:

```
W?method$_class$n__v
```

## 5.1.5 Borland

Here is an example of Borland Delphi's and C++Builder's [name mangling](#):

```
@TApplication@IdleAction$qv
@TApplication@ProcessMDIAccels$qp6tagMSG
@TModule@$bctr$qpcpvt1
@TModule@$bdtr$qv
@TModule@ValidWindow$qp14TWindowsObject
@TrueColorTo8BitN$qpviiiiitliiiii
@TrueColorTo16BitN$qpviiiiitliiiii
@DIB24BitTo8BitBitmap$qpviiiiitliiiii
@TrueBitmap@$bctr$qpcl
@TrueBitmap@$bctr$qpvl
@TrueBitmap@$bctr$qiilll
```

The names always start with the @ symbol, then we have the class name came, method name, and encoded the types of the arguments of the method.

These names can be in the .exe imports, .dll exports, debug data, etc.

Borland Visual Component Libraries (VCL) are stored in .bpl files instead of .dll ones, for example, vcl50.dll, rtl60.dll.

Another DLL that might be imported: BORLNDMM.DLL.

### Delphi

Almost all Delphi executables has the "Boolean" text string at the beginning of the code segment, along with other type names.

This is a very typical beginning of the CODE segment of a Delphi program, this block came right after the win32 PE file header:

```
00000400 04 10 40 00 03 07 42 6f 6f 6c 65 61 6e 01 00 00 |..@...Boolean...|
00000410 00 00 01 00 00 00 00 10 40 00 05 46 61 6c 73 65 |.....@..False|
00000420 04 54 72 75 65 8d 40 00 2c 10 40 00 09 08 57 69 |.True.@.,.@...Wi|
00000430 64 65 43 68 61 72 03 00 00 00 00 ff ff 00 00 90 |deChar.....|
00000440 44 10 40 00 02 04 43 68 61 72 01 00 00 00 00 ff |D.@...Char.....|
00000450 00 00 00 90 58 10 40 00 01 08 53 6d 61 6c 6c 69 |...X.@...Smalli|
00000460 6e 74 02 00 80 ff ff ff 7f 00 00 90 70 10 40 00 |nt.....p.@.|
00000470 01 07 49 6e 74 65 67 65 72 04 00 00 00 80 ff ff |..Integer.....|
00000480 ff 7f 8b c0 88 10 40 00 01 04 42 79 74 65 01 00 |.....@...Byte..|
00000490 00 00 00 ff 00 00 00 90 9c 10 40 00 01 04 57 6f |.....@...Wo|
000004a0 72 64 03 00 00 00 00 ff ff 00 00 90 b0 10 40 00 |rd.....|
000004b0 01 08 43 61 72 64 69 6e 61 6c 05 00 00 00 00 ff |..Cardinal.....|
000004c0 ff ff ff 90 c8 10 40 00 10 05 49 6e 74 36 34 00 |.....@...Int64.|
000004d0 00 00 00 00 00 00 80 ff ff ff ff ff ff 7f 90 |.....|
000004e0 e4 10 40 00 04 08 45 78 74 65 6e 64 65 64 02 90 |..@...Extended..|
000004f0 f4 10 40 00 04 06 44 6f 75 62 6c 65 01 8d 40 00 |..@...Double..@.|
00000500 04 11 40 00 04 08 43 75 72 72 65 6e 63 79 04 90 |..@...Currency..|
00000510 14 11 40 00 0a 06 73 74 72 69 6e 67 20 11 40 00 |..@...string .@.|
00000520 0b 0a 57 69 64 65 53 74 72 69 6e 67 30 11 40 00 |..WideString0.@.|
00000530 0c 07 56 61 72 69 61 6e 74 8d 40 00 40 11 40 00 |..Variant.@.@.@|
00000540 0c 0a 4f 6c 65 56 61 72 69 61 6e 74 98 11 40 00 |..OleVariant..@.|
00000550 00 00 00 00 00 00 00 00 00 00 00 00 00 00 00 |.....|
00000560 00 00 00 00 00 00 00 00 00 00 00 00 98 11 40 00 |.....@.|
00000570 04 00 00 00 00 00 00 18 4d 40 00 24 4d 40 00 |.....M@.$M@.|
00000580 28 4d 40 00 2c 4d 40 00 20 4d 40 00 68 4a 40 00 |(M@.,M@. M@.hJ@.|
00000590 84 4a 40 00 c0 4a 40 00 07 54 4f 62 6a 65 63 74 |.J@..J@..TObject|
000005a0 a4 11 40 00 07 07 54 4f 62 6a 65 63 74 98 11 40 |..@...TObject..@|
000005b0 00 00 00 00 00 00 06 53 79 73 74 65 6d 00 00 |.....System..|
000005c0 c4 11 40 00 0f 0a 49 49 6e 74 65 72 66 61 63 65 |..@...IInterface|
000005d0 00 00 00 00 01 00 00 00 00 00 00 00 00 c0 00 00 |.....|
000005e0 00 00 00 00 46 06 53 79 73 74 65 6d 03 00 ff ff |....F.System....|
000005f0 f4 11 40 00 0f 09 49 44 69 73 70 61 74 63 68 c0 |..@...IDispatch.|
00000600 11 40 00 01 00 04 02 00 00 00 00 00 c0 00 00 00 |.@.....|
00000610 00 00 00 46 06 53 79 73 74 65 6d 04 00 ff ff 90 |...F.System.....|
00000620 cc 83 44 24 04 f8 e9 51 6c 00 00 83 44 24 04 f8 |..D$...Ql...D$..|
00000630 e9 6f 6c 00 00 83 44 24 04 f8 e9 79 6c 00 00 cc |.ol...D$...yl...|
00000640 cc 21 12 40 00 2b 12 40 00 35 12 40 00 01 00 00 |!.@.+.@.5.@....|
```

00000650	00 00 00 00 00 00 00 00	00 c0 00 00 00 00 00 00	.....
00000660	46 41 12 40 00 08 00 00	00 00 00 00 00 8d 40 00	FA.@.....@
00000670	bc 12 40 00 4d 12 40 00	00 00 00 00 00 00 00 00	..@.M.@.....
00000680	00 00 00 00 00 00 00 00	00 00 00 00 00 00 00 00	.....
00000690	bc 12 40 00 0c 00 00 00	4c 11 40 00 18 4d 40 00	..@.....L.@..M@
000006a0	50 7e 40 00 5c 7e 40 00	2c 4d 40 00 20 4d 40 00	P~@.\~@.,M@. M@
000006b0	6c 7e 40 00 84 4a 40 00	c0 4a 40 00 11 54 49 6e	l~@..J@..J@..TIn
000006c0	74 65 72 66 61 63 65 64	4f 62 6a 65 63 74 8b c0	terfacedObject..
000006d0	d4 12 40 00 07 11 54 49	6e 74 65 72 66 61 63 65	..@...TInterface
000006e0	64 4f 62 6a 65 63 74 bc	12 40 00 a0 11 40 00 00	dObject..@...@..
000006f0	00 06 53 79 73 74 65 6d	00 00 8b c0 00 13 40 00	..System.....@
00000700	11 0b 54 42 6f 75 6e 64	41 72 72 61 79 04 00 00	..TBoundArray...
00000710	00 00 00 00 00 03 00 00	00 6c 10 40 00 06 53 79	.....l.@..Sy
00000720	73 74 65 6d 28 13 40 00	04 09 54 44 61 74 65 54	stem(.@...TDateT
00000730	69 6d 65 01 ff 25 48 e0	c4 00 8b c0 ff 25 44 e0	ime..%H.....%D

The first 4 bytes of the data segment (DATA) can be 00 00 00 00, 32 13 8B C0 or FF FF FF FF. This information can be useful when dealing with packed/encrypted Delphi executables.

### 5.1.6 Other known DLLs

- vcomp\*.dll—Microsoft’s implementation of OpenMP.

## 5.2 Communication with outer world (function level)

It’s often advisable to track function arguments and return values in debugger or DBI. For example, the author once tried to understand meaning of some obscure function, which happens to be incorrectly implemented bubble sort<sup>4</sup>. (It worked correctly, but slower.) Meanwhile, watching inputs and outputs of this function helps instantly to understand what it does.

Often, when you see division by multiplication ( 3.12 on page 500), but forgot all details about its mechanics, you can just observe input and output and quickly find divisor.

## 5.3 Communication with the outer world (win32)

Sometimes it’s enough to observe some function’s inputs and outputs in order to understand what it does. That way you can save time.

Files and registry access: for the very basic analysis, Process Monitor<sup>5</sup> utility from SysInternals can help.

For the basic analysis of network accesses, Wireshark<sup>6</sup> can be useful.

But then you will have to look inside anyway.

The first thing to look for is which functions from the OS’s APIs and standard libraries are used.

If the program is divided into a main executable file and a group of DLL files, sometimes the names of the functions in these DLLs can help.

If we are interested in exactly what can lead to a call to MessageBox() with specific text, we can try to find this text in the data segment, find the references to it and find the points from which the control may be passed to the MessageBox() call we’re interested in.

If we are talking about a video game and we’re interested in which events are more or less random in it, we may try to find the rand() function or its replacements (like the Mersenne twister algorithm) and find the places from which those functions are called, and more importantly, how are the results used. One example: 8.3 on page 802.

But if it is not a game, and rand() is still used, it is also interesting to know why. There are cases of unexpected rand() usage in data compression algorithms (for encryption imitation): [blog.yurichev.com](http://blog.yurichev.com).

<sup>4</sup>[https://yurichev.com/blog/weird\\_sort\\_KLEE/](https://yurichev.com/blog/weird_sort_KLEE/)

<sup>5</sup><http://go.yurichev.com/17301>

<sup>6</sup><http://go.yurichev.com/17303>

### 5.3.1 Often used functions in the Windows API

These functions may be among the imported. It is worth to note that not every function might be used in the code that was written by the programmer. A lot of functions might be called from library functions and CRT code.

Some functions may have the -A suffix for the ASCII version and -W for the Unicode version.

- Registry access (advapi32.dll): RegEnumKeyEx, RegEnumValue, RegGetValue, RegOpenKeyEx, RegQueryValueEx.
- Access to text .ini-files (kernel32.dll): GetPrivateProfileString.
- Dialog boxes (user32.dll): MessageBox, MessageBoxEx, CreateDialog, SetDlgItemText, GetDlgItemText.
- Resources access ( 6.5.2 on page 765): (user32.dll): LoadMenu.
- TCP/IP networking (ws2\_32.dll): WSARcv, WSASend.
- File access (kernel32.dll): CreateFile, ReadFile, ReadFileEx, WriteFile, WriteFileEx.
- High-level access to the Internet (wininet.dll): WinHttpOpen.
- Checking the digital signature of an executable file (wintrust.dll): WinVerifyTrust.
- The standard MSVC library (if it's linked dynamically) (msvcr\*.dll): assert, itoa, ltoa, open, printf, read, strcmp, atol, atoi, fopen, fread, fwrite, memcmp, rand, strlen, strstr, strchr.

### 5.3.2 Extending trial period

Registry access functions are frequent targets for those who try to crack trial period of some software, which may save installation date/time into registry.

Another popular target are GetLocalTime() and GetSystemTime() functions: a trial software, at each startup, must check current date/time somehow anyway.

### 5.3.3 Removing nag dialog box

A popular way to find out what causing popping nag dialog box is intercepting MessageBox(), CreateDialog() and CreateWindow() functions.

### 5.3.4 tracer: Intercepting all functions in specific module

There are INT3 breakpoints in the [tracer](#), that are triggered only once, however, they can be set for all functions in a specific DLL.

```
--one-time-INT3-bp:somedll.dll!.*
```

Or, let's set INT3 breakpoints on all functions with the xml prefix in their name:

```
--one-time-INT3-bp:somedll.dll!xml.*
```

On the other side of the coin, such breakpoints are triggered only once. Tracer will show the call of a function, if it happens, but only once. Another drawback—it is impossible to see the function's arguments.

Nevertheless, this feature is very useful when you know that the program uses a DLL, but you do not know which functions are actually used. And there are a lot of functions.

For example, let's see, what does the uptime utility from cygwin use:

```
tracer -l:uptime.exe --one-time-INT3-bp:cygwin1.dll!.*
```

Thus we may see all that cygwin1.dll library functions that were called at least once, and where from:

```

One-time INT3 breakpoint: cygwin1.dll!__main (called from uptime.exe!0EP+0x6d (0x40106d))
One-time INT3 breakpoint: cygwin1.dll!_getuid32 (called from uptime.exe!0EP+0xba3 (0x401ba3))
One-time INT3 breakpoint: cygwin1.dll!_getuid32 (called from uptime.exe!0EP+0xbaa (0x401baa))
One-time INT3 breakpoint: cygwin1.dll!_getegid32 (called from uptime.exe!0EP+0xcb7 (0x401cb7))
One-time INT3 breakpoint: cygwin1.dll!_getgid32 (called from uptime.exe!0EP+0xcbe (0x401cbe))
One-time INT3 breakpoint: cygwin1.dll!sysconf (called from uptime.exe!0EP+0x735 (0x401735))
One-time INT3 breakpoint: cygwin1.dll!setlocale (called from uptime.exe!0EP+0x7b2 (0x4017b2))
One-time INT3 breakpoint: cygwin1.dll!_open64 (called from uptime.exe!0EP+0x994 (0x401994))
One-time INT3 breakpoint: cygwin1.dll!_lseek64 (called from uptime.exe!0EP+0x7ea (0x4017ea))
One-time INT3 breakpoint: cygwin1.dll!read (called from uptime.exe!0EP+0x809 (0x401809))
One-time INT3 breakpoint: cygwin1.dll!sscanf (called from uptime.exe!0EP+0x839 (0x401839))
One-time INT3 breakpoint: cygwin1.dll!uname (called from uptime.exe!0EP+0x139 (0x401139))
One-time INT3 breakpoint: cygwin1.dll!time (called from uptime.exe!0EP+0x22e (0x40122e))
One-time INT3 breakpoint: cygwin1.dll!localtime (called from uptime.exe!0EP+0x236 (0x401236))
One-time INT3 breakpoint: cygwin1.dll!sprintf (called from uptime.exe!0EP+0x25a (0x40125a))
One-time INT3 breakpoint: cygwin1.dll!setutent (called from uptime.exe!0EP+0x3b1 (0x4013b1))
One-time INT3 breakpoint: cygwin1.dll!getutent (called from uptime.exe!0EP+0x3c5 (0x4013c5))
One-time INT3 breakpoint: cygwin1.dll!endutent (called from uptime.exe!0EP+0x3e6 (0x4013e6))
One-time INT3 breakpoint: cygwin1.dll!puts (called from uptime.exe!0EP+0x4c3 (0x4014c3))

```

## 5.4 Strings

### 5.4.1 Text strings

#### C/C++

The normal C strings are zero-terminated ([ASCIIZ](#)-strings).

The reason why the C string format is as it is (zero-terminated) is apparently historical. In [Dennis M. Ritchie, *The Evolution of the Unix Time-sharing System*, (1979)] we read:

A minor difference was that the unit of I/O was the word, not the byte, because the PDP-7 was a word-addressed machine. In practice this meant merely that all programs dealing with character streams ignored null characters, because null was used to pad a file to an even number of characters.

In Hiew or FAR Manager these strings look like this:

```

int main()
{
    printf ("Hello, world!\n");
};

```

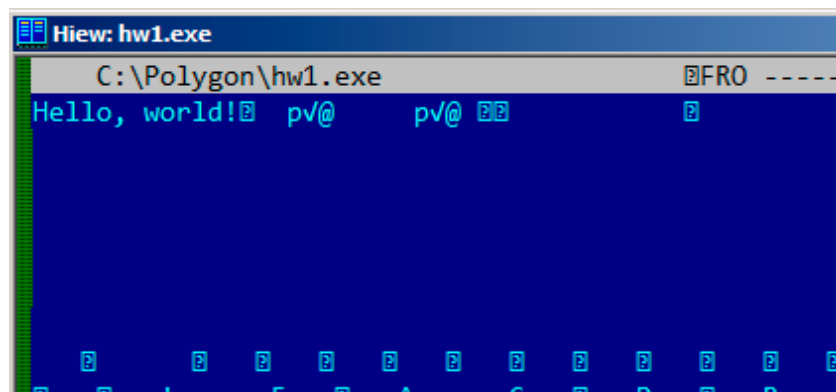

Figure 5.1: Hiew

#### Borland Delphi

The string in Pascal and Borland Delphi is preceded by an 8-bit or 32-bit string length.

For example:

Listing 5.1: Delphi

```

CODE:00518AC8          dd 19h
CODE:00518ACC  aLoading__Plea db 'Loading... , please wait.',0

...

CODE:00518AFC          dd 10h
CODE:00518B00  aPreparingRun__ db 'Preparing run... ',0

```

### Unicode

Often, what is called Unicode is a methods for encoding strings where each character occupies 2 bytes or 16 bits. This is a common terminological mistake. Unicode is a standard for assigning a number to each character in the many writing systems of the world, but does not describe the encoding method.

The most popular encoding methods are: UTF-8 (is widespread in Internet and \*NIX systems) and UTF-16LE (is used in Windows).

### UTF-8

UTF-8 is one of the most successful methods for encoding characters. All Latin symbols are encoded just like in ASCII, and the symbols beyond the ASCII table are encoded using several bytes. 0 is encoded as before, so all standard C string functions work with UTF-8 strings just like any other string.

Let's see how the symbols in various languages are encoded in UTF-8 and how it looks like in FAR, using the 437 codepage <sup>7</sup>:

```

How much? 100€?

(English) I can eat glass and it doesn't hurt me.
(Greek) Μπορώ να φάω σπασμένα γυαλιά χωρίς να πάθω τίποτα.
(Hungarian) Meg tudom enni az üveget, nem lesz tőle bajom.
(Icelandic) Ég get etið gler án þess að meiða mig.
(Polish) Mogę jeść szkło i mi nie szkodzi.
(Russian) Я могу есть стекло, оно мне не вредит.
(Arabic) أنا قادر على أكل الزجاج و هذا لا يؤلمني.
(Hebrew) אני יכול לאכול זכוכית וזה לא מזיק לי.
(Chinese) 我能吞下玻璃而不伤身体。
(Japanese) 私はガラスを食べられます。それは私を傷つけません。
(Hindi) मैं काँच खा सकता हूँ और मुझे उससे कोई चोट नहीं पहुंचती.

```

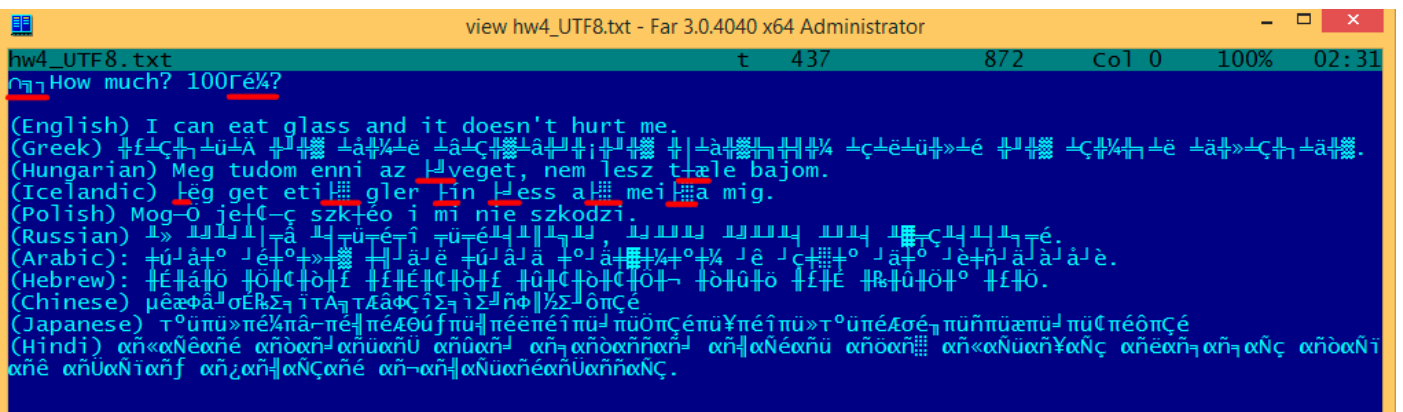

Figure 5.2: FAR: UTF-8

As you can see, the English language string looks the same as it is in ASCII.

<sup>7</sup>The example and translations was taken from here: <http://go.yurichev.com/17304>

The Hungarian language uses some Latin symbols plus symbols with diacritic marks.

These symbols are encoded using several bytes, these are underscored with red. It's the same story with the Icelandic and Polish languages.

There is also the "Euro" currency symbol at the start, which is encoded with 3 bytes.

The rest of the writing systems here have no connection with Latin.

At least in Russian, Arabic, Hebrew and Hindi we can see some recurring bytes, and that is not surprise: all symbols from a writing system are usually located in the same Unicode table, so their code begins with the same numbers.

At the beginning, before the "How much?" string we see 3 bytes, which are in fact the [BOM](#)<sup>8</sup>. The [BOM](#) defines the encoding system to be used.

## UTF-16LE

Many win32 functions in Windows have the suffixes `-A` and `-W`. The first type of functions works with normal strings, the other with UTF-16LE strings (*wide*).

In the second case, each symbol is usually stored in a 16-bit value of type *short*.

The Latin symbols in UTF-16 strings look in Hiew or FAR like they are interleaved with zero byte:

```
int wmain()
{
    wprintf (L"Hello, world!\n");
};
```

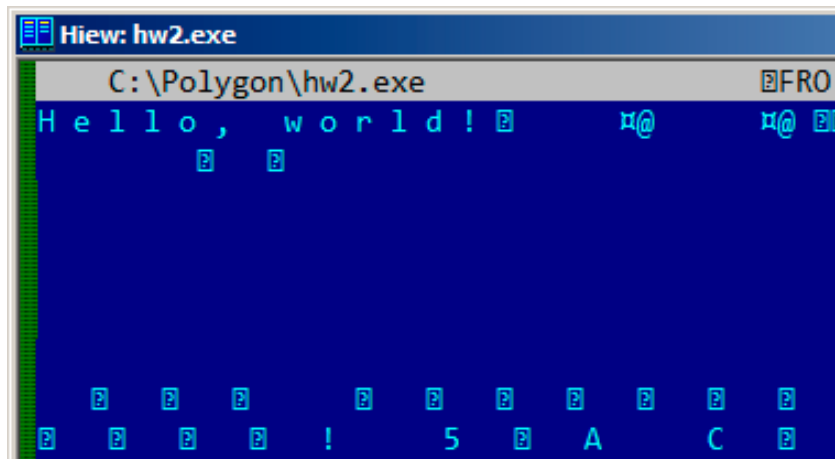

Figure 5.3: Hiew

We can see this often in [Windows NT](#) system files:

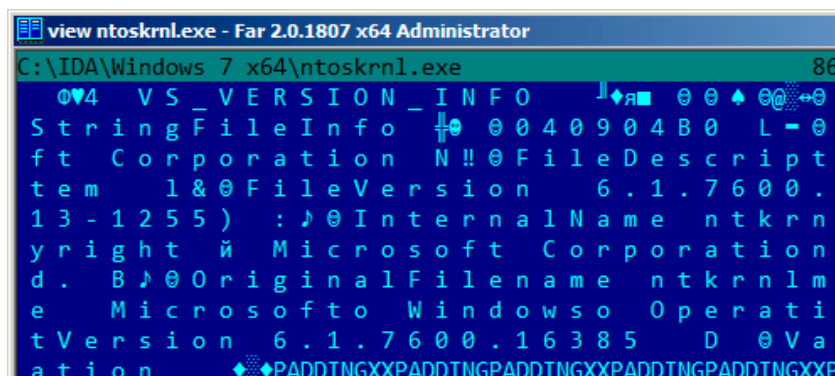

Figure 5.4: Hiew

<sup>8</sup>Byte Order Mark

Strings with characters that occupy exactly 2 bytes are called “Unicode” in IDA:

```
.data:0040E000 aHelloWorld:
.data:0040E000          unicode 0, <Hello, world!>
.data:0040E000          dw 0Ah, 0
```

Here is how the Russian language string is encoded in UTF-16LE:

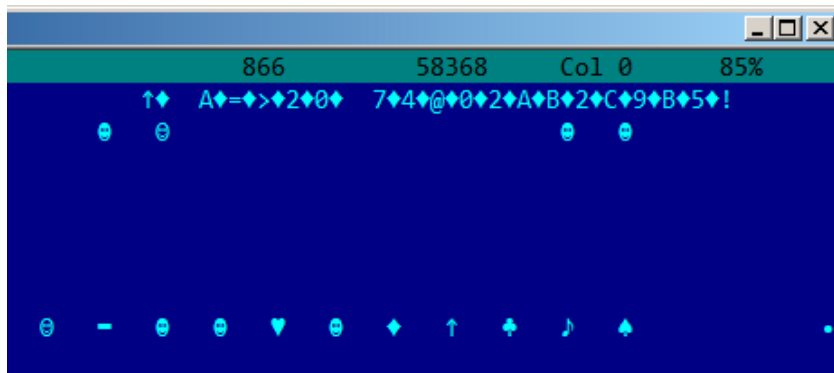

Figure 5.5: Hiew: UTF-16LE

What we can easily spot is that the symbols are interleaved by the diamond character (which has the ASCII code of 4). Indeed, the Cyrillic symbols are located in the fourth Unicode plane. Hence, all Cyrillic symbols in UTF-16LE are located in the 0x400-0x4FF range.

Let’s go back to the example with the string written in multiple languages. Here is how it looks like in UTF-16LE.

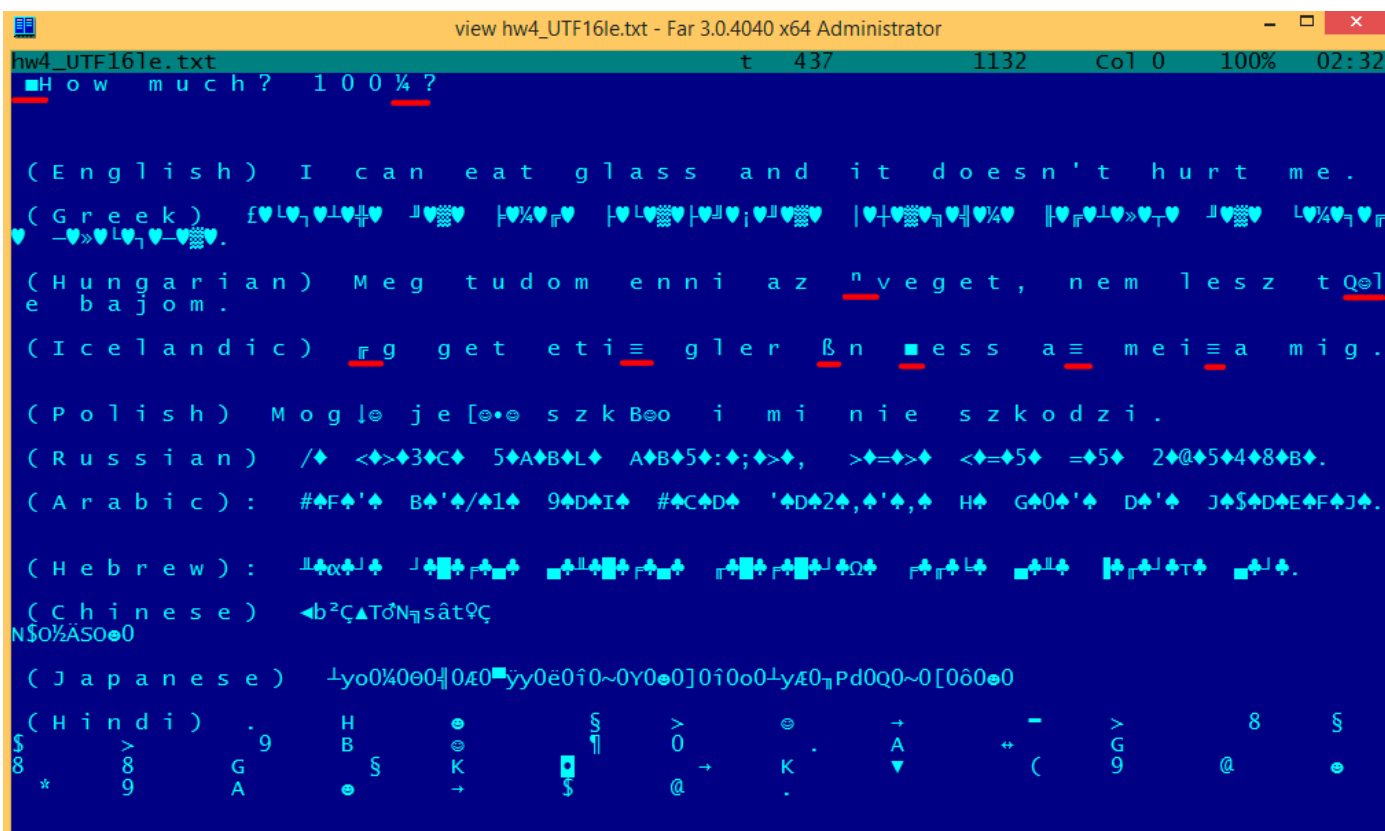

Figure 5.6: FAR: UTF-16LE

Here we can also see the BOM at the beginning. All Latin characters are interleaved with a zero byte. Some characters with diacritic marks (Hungarian and Icelandic languages) are also underscored in red.



## Base64

The base64 encoding is highly popular for the cases when you have to transfer binary data as a text string. In essence, this algorithm encodes 3 binary bytes into 4 printable characters: all 26 Latin letters (both lower and upper case), digits, plus sign (“+”) and slash sign (“/”), 64 characters in total.

One distinctive feature of base64 strings is that they often (but not always) end with 1 or 2 [padding](#) equality symbol(s) (“=”), for example:

```
AVjbbVSVfcUMu1xvjaMgjNtueRwBbxnyJw8dpGnLW8ZW8aKG3v4Y0icuQT+qEJAp9LA0uWs=
```

```
WVjbbVSVfcUMu1xvjaMgjNtueRwBbxnyJw8dpGnLW8ZW8aKG3v4Y0icuQT+qEJAp9LA0uQ==
```

The equality sign (“=”) is never encounter in the middle of base64-encoded strings.

Now example of manual encoding. Let’s encode 0x00, 0x11, 0x22, 0x33 hexadecimal bytes into base64 string:

```
$ echo -n "\x00\x11\x22\x33" | base64
ABEiMw==
```

Let’s put all 4 bytes in binary form, then regroup them into 6-bit groups:

```
| 00 || 11 || 22 || 33 ||      ||      |
00000000000100010010001000110011????????????????
| A  || B  || E  || i  || M  || w  || =  || =  |
```

Three first bytes (0x00, 0x11, 0x22) can be encoded into 4 base64 characters (“ABEi”), but the last one (0x33) — cannot be, so it’s encoded using two characters (“Mw”) and [padding](#) symbol (“=”) is added twice to pad the last group to 4 characters. Hence, length of all correct base64 strings are always divisible by 4.

Base64 is often used when binary data needs to be stored in XML. “Armored” (i.e., in text form) PGP keys and signatures are encoded using base64.

Some people tries to use base64 to obfuscate strings: <http://blog.sec-consult.com/2016/01/deliberately-html><sup>9</sup>.

There are utilities for scanning an arbitrary binary files for base64 strings. One such utility is base64scanner<sup>10</sup>.

Another encoding system which was much more popular in UseNet and FidoNet is Uuencoding. Binary files are still encoded in Uuencode format in Phrack magazine. It offers mostly the same features, but is different from base64 in the sense that file name is also stored in header.

By the way: there is also close sibling to base64: base32, alphabet of which has 10 digits and 26 Latin characters. One well-known usage of it is onion addresses<sup>11</sup>, like: <http://3g2upl4pq6kufc4m.onion/>. URL can’t have mixed-case Latin characters, so apparently, this is why Tor developers used base32.

### 5.4.2 Finding strings in binary

Actually, the best form of Unix documentation is frequently running the **strings** command over a program’s object code. Using **strings**, you can get a complete list of the program’s hard-coded file name, environment variables, undocumented options, obscure error messages, and so forth.

The Unix-Haters Handbook

<sup>9</sup><http://archive.is/nDCas>

<sup>10</sup><https://github.com/DennisYurichev/base64scanner>

<sup>11</sup><https://trac.torproject.org/projects/tor/wiki/doc/HiddenServiceNames>

The standard UNIX *strings* utility is quick-n-dirty way to see strings in file. For example, these are some strings from OpenSSH 7.2 `sshd` executable file:

```
...
0123
0123456789
0123456789abcdefABCDEF.:/
%02x
...
%.100s, line %lu: Bad permitopen specification <%.100s>
%.100s, line %lu: invalid criteria
%.100s, line %lu: invalid tun device
...
%.200s/.ssh/environment
...
2886173b9c9b6fdbdeda7a247cd636db38deaa.debug
$2a$06$r3.juUaHZDlIbQa02dS9FuYxL1W9M81R1Tc92PoSNmzvpEqLkLGrK
...
3des-cbc
...
Bind to port %s on %s.
Bind to port %s on %s failed: %.200s.
/bin/login
/bin/sh
/bin/sh /etc/ssh/sshrC
...
D$4PQWR1
D$4PUj
D$4PV
D$4PVj
D$4PW
D$4PWj
D$4X
D$4XZj
D$4Y
...
diffie-hellman-group-exchange-sha1
diffie-hellman-group-exchange-sha256
digests
D$iPV
direct-streamlocal
direct-streamlocal@openssh.com
...
FFFFFFFFFFFFFFFFC90FDAA22168C234C4C6628B80DC1CD129024E088A6...
...
```

There are options, error messages, file paths, imported dynamic modules and functions, some other strange strings (keys?) There is also unreadable noise—x86 code sometimes has chunks consisting of printable ASCII characters, up to 8 characters.

Of course, OpenSSH is open-source program. But looking at readable strings inside of some unknown binary is often a first step of analysis.

*grep* can be applied as well.

Hiew has the same capability (Alt-F6), as well as Sysinternals ProcessMonitor.

### 5.4.3 Error/debug messages

Debugging messages are very helpful if present. In some sense, the debugging messages are reporting what's going on in the program right now. Often these are `printf()`-like functions, which write to log-files, or sometimes do not writing anything but the calls are still present since the build is not a debug one but *release* one.

If local or global variables are dumped in debug messages, it might be helpful as well since it is possible to get at least the variable names. For example, one of such function in Oracle RDBMS is `ksdwrt()`.

Meaningful text strings are often helpful. The [IDA](#) disassembler may show from which function and from which point this specific string is used. Funny cases sometimes happen<sup>12</sup>.

<sup>12</sup>[blog.yurichev.com](http://blog.yurichev.com)

The error messages may help us as well. In Oracle RDBMS, errors are reported using a group of functions. You can read more about them here: [blog.yurichev.com](http://blog.yurichev.com).

It is possible to find quickly which functions report errors and in which conditions.

By the way, this is often the reason why copy-protection systems use inarticulate cryptic error messages or just error numbers. No software author is happy if the software cracker can quickly understand copy-protection's inner workings judging by error messages it can produce.

One example of encrypted error messages is here: [8.8.2 on page 837](#).

#### 5.4.4 Suspicious magic strings

Some magic strings which are usually used in backdoors look pretty suspicious.

For example, there was a backdoor in the TP-Link WR740 home router<sup>13</sup>. The backdoor can be activated using the following URL:

[http://192.168.0.1/userRpmNatDebugRpm26525557/start\\_art.html](http://192.168.0.1/userRpmNatDebugRpm26525557/start_art.html).

Indeed, the "userRpmNatDebugRpm26525557" string is present in the firmware.

This string was not googleable until the wide disclosure of information about the backdoor.

You would not find this in any RFC<sup>14</sup>.

You would not find any computer science algorithm which uses such strange byte sequences.

And it doesn't look like an error or debugging message.

So it's a good idea to inspect the usage of such weird strings.

Sometimes, such strings are encoded using base64.

So it's a good idea to decode them all and to scan them visually, even a glance should be enough.

More precisely, this method of hiding backdoors is called "security through obscurity".

### 5.5 Calls to assert()

Sometimes the presence of the `assert()` macro is useful too: commonly this macro leaves source file name, line number and condition in the code.

The most useful information is contained in the `assert()`'s condition, we can deduce variable names or structure field names from it. Another useful piece of information are the file names—we can try to deduce what type of code is there. Also it is possible to recognize well-known open-source libraries by the file names.

Listing 5.2: Example of informative `assert()` calls

```
.text:107D4B29 mov dx, [ecx+42h]
.text:107D4B2D cmp edx, 1
.text:107D4B30 jz short loc_107D4B4A
.text:107D4B32 push 1ECh
.text:107D4B37 push offset aWrite_c ; "write.c"
.text:107D4B3C push offset aTdTd_planarcon ; "td->td_planarconfig == PLANARCONFIG_CON"...
.text:107D4B41 call ds:_assert

...

.text:107D52CA mov edx, [ebp-4]
.text:107D52CD and edx, 3
.text:107D52D0 test edx, edx
.text:107D52D2 jz short loc_107D52E9
.text:107D52D4 push 58h
.text:107D52D6 push offset aDumpmode_c ; "dumpmode.c"
.text:107D52DB push offset aN30 ; "(n & 3) == 0"
```

<sup>13</sup><http://sekurak.pl/tp-link-httpftf-backdoor/>

<sup>14</sup>Request for Comments

```
.text:107D52E0 call ds:_assert
...
.text:107D6759 mov cx, [eax+6]
.text:107D675D cmp ecx, 0Ch
.text:107D6760 jle short loc_107D677A
.text:107D6762 push 2D8h
.text:107D6767 push offset aLzw_c ; "lzw.c"
.text:107D676C push offset aSpLzw_nbitsBit ; "sp->lzw_nbits <= BITS_MAX"
.text:107D6771 call ds:_assert
```

It is advisable to “google” both the conditions and file names, which can lead us to an open-source library. For example, if we “google” “sp->lzw\_nbits <= BITS\_MAX”, this predictably gives us some open-source code that’s related to the LZW compression.

## 5.6 Constants

Humans, including programmers, often use round numbers like 10, 100, 1000, in real life as well as in the code.

The practicing reverse engineer usually know them well in hexadecimal representation: 10=0xA, 100=0x64, 1000=0x3E8, 10000=0x2710.

The constants 0xAAAAAAAA (0b10101010101010101010101010101010) and 0x55555555 (0b010101010101010101010101010101) are also popular—those are composed of alternating bits.

That may help to distinguish some signal from a signal where all bits are turned on (0b1111 ...) or off (0b0000 ...). For example, the 0x55AA constant is used at least in the boot sector, [MBR<sup>15</sup>](#), and in the [ROM](#) of IBM-compatible extension cards.

Some algorithms, especially cryptographical ones use distinct constants, which are easy to find in code using [IDA](#).

For example, the MD5 algorithm initializes its own internal variables like this:

```
var int h0 := 0x67452301
var int h1 := 0xEFCDAB89
var int h2 := 0x98BADCFE
var int h3 := 0x10325476
```

If you find these four constants used in the code in a row, it is highly probable that this function is related to MD5.

Another example are the CRC16/CRC32 algorithms, whose calculation algorithms often use precomputed tables like this one:

Listing 5.3: linux/lib/crc16.c

```
/** CRC table for the CRC-16. The poly is 0x8005 (x^16 + x^15 + x^2 + 1) */
u16 const crc16_table[256] = {
    0x0000, 0xC0C1, 0xC181, 0x0140, 0xC301, 0x03C0, 0x0280, 0xC241,
    0xC601, 0x06C0, 0x0780, 0xC741, 0x0500, 0xC5C1, 0xC481, 0x0440,
    0xCC01, 0x0CC0, 0x0D80, 0xCD41, 0x0F00, 0xCFC1, 0xCE81, 0x0E40,
    ...
}
```

See also the precomputed table for CRC32: [3.8 on page 486](#).

In tableless CRC algorithms well-known polynomials are used, for example, 0xEDB88320 for CRC32.

### 5.6.1 Magic numbers

A lot of file formats define a standard file header where a *magic number(s)* is used, single one or even several.

<sup>15</sup>Master Boot Record

For example, all Win32 and MS-DOS executables start with the two characters “MZ”.

At the beginning of a MIDI file the “MThd” signature must be present. If we have a program which uses MIDI files for something, it’s very likely that it must check the file for validity by checking at least the first 4 bytes.

This could be done like this: (*buf* points to the beginning of the loaded file in memory)

```
cmp [buf], 0x6468544D ; "MThd"
jnz _error_not_a_MIDI_file
```

...or by calling a function for comparing memory blocks like `memcmp()` or any other equivalent code up to a `CMP SB (.1.6 on page 1033)` instruction.

When you find such point you already can say where the loading of the MIDI file starts, also, we could see the location of the buffer with the contents of the MIDI file, what is used from the buffer, and how.

## Dates

Often, one may encounter number like `0x19870116`, which is clearly looks like a date (year 1987, 1th month (January), 16th day). This may be someone’s birthday date (a programmer, his/her relative, child), or some other important date. The date may also be written in a reverse order, like `0x16011987`. American-style dates are also popular, like `0x01161987`.

Well-known example is `0x19540119` (magic number used in UFS2 superblock structure), which is a birthday date of Marshall Kirk McKusick, prominent FreeBSD contributor.

Stuxnet uses the number “19790509” (not as 32-bit number, but as string, though), and this led to speculation that the malware is connected to Israel<sup>16</sup>.

Also, numbers like those are very popular in amateur-grade cryptography, for example, excerpt from the *secret function* internals from HASP3 dongle<sup>17</sup>:

```
void xor_pwd(void)
{
    int i;

    pwd ^= 0x09071966;
    for(i=0; i<8; i++)
    {
        a_l_buf[i] = pwd & 7; pwd = pwd >> 3;
    }
};

void emulate_func2(unsigned short seed)
{
    int i, j;
    for(i=0; i<8; i++)
    {
        ch[i] = 0;

        for(j=0; j<8; j++)
        {
            seed *= 0x1989;
            seed += 5;
            ch[i] |= (tab[(seed >> 9) & 0x3f]) << (7-j);
        }
    }
}
```

## DHCP

This applies to network protocols as well. For example, the DHCP protocol’s network packets contains the so-called *magic cookie*: `0x63538263`. Any code that generates DHCP packets somewhere must embed

<sup>16</sup>This is a date of execution of Habib Elghanian, persian jew.

<sup>17</sup><https://web.archive.org/web/20160311231616/http://www.woodmann.com/fravia/bayu3.htm>

this constant into the packet. If we find it in the code we may find where this happens and, not only that. Any program which can receive DHCP packet must verify the *magic cookie*, comparing it with the constant.

For example, let's take the `dhcpcore.dll` file from Windows 7 x64 and search for the constant. And we can find it, twice: it seems that the constant is used in two functions with descriptive names `DhcpExtractOptionsForValidation()` and `DhcpExtractFullOptions()`:

Listing 5.4: `dhcpcore.dll` (Windows 7 x64)

```
.rdata:000007FF6483CBE8 dword_7FF6483CBE8 dd 63538263h ; DATA XREF:
DhcpExtractOptionsForValidation+79
.rdata:000007FF6483CBEC dword_7FF6483CBEC dd 63538263h ; DATA XREF:
DhcpExtractFullOptions+97
```

And here are the places where these constants are accessed:

Listing 5.5: `dhcpcore.dll` (Windows 7 x64)

```
.text:000007FF6480875F mov     eax, [rsi]
.text:000007FF64808761 cmp     eax, cs:dword_7FF6483CBE8
.text:000007FF64808767 jnz    loc_7FF64817179
```

And:

Listing 5.6: `dhcpcore.dll` (Windows 7 x64)

```
.text:000007FF648082C7 mov     eax, [r12]
.text:000007FF648082CB cmp     eax, cs:dword_7FF6483CBEC
.text:000007FF648082D1 jnz    loc_7FF648173AF
```

## 5.6.2 Specific constants

Sometimes, there is a specific constant for some type of code. For example, the author once dug into a code, where number 12 was encountered suspiciously often. Size of many arrays is 12, or multiple of 12 (24, etc). As it turned out, that code takes 12-channel audio file at input and process it.

And vice versa: for example, if a program works with text field which has length of 120 bytes, there has to be a constant 120 or 119 somewhere in the code. If UTF-16 is used, then  $2 \cdot 120$ . If a code works with network packets of fixed size, it's good idea to search for this constant in the code as well.

This is also true for amateur cryptography (license keys, etc). If encrypted block has size of  $n$  bytes, you may want to try to find occurrences of this number throughout the code. Also, if you see a piece of code which is been repeated  $n$  times in loop during execution, this may be encryption/decryption routine.

## 5.6.3 Searching for constants

It is easy in [IDA](#): Alt-B or Alt-I. And for searching for a constant in a big pile of files, or for searching in non-executable files, there is a small utility called *binary grep*<sup>18</sup>.

## 5.7 Finding the right instructions

If the program is utilizing FPU instructions and there are very few of them in the code, one can try to check each one manually with a debugger.

For example, we may be interested how Microsoft Excel calculates the formulae entered by user. For example, the division operation.

If we load `excel.exe` (from Office 2010) version 14.0.4756.1000 into [IDA](#), make a full listing and to find every `FDIV` instruction (except the ones which use constants as a second operand—obviously, they do not suit us):

<sup>18</sup>[GitHub](#)

```
cat EXCEL.lst | grep fdiv | grep -v dbl_ > EXCEL.fdiv
```

...then we see that there are 144 of them.

We can enter a string like `=(1/3)` in Excel and check each instruction.

By checking each instruction in a debugger or [tracer](#) (one may check 4 instruction at a time), we get lucky and the sought-for instruction is just the 14th:

```
.text:3011E919 DC 33          fdiv    qword ptr [ebx]
```

```
PID=13944|TID=28744|(0) 0x2f64e919 (Excel.exe!BASE+0x11e919)
EAX=0x02088006 EBX=0x02088018 ECX=0x00000001 EDX=0x00000001
ESI=0x02088000 EDI=0x00544804 EBP=0x0274FA3C ESP=0x0274F9F8
EIP=0x2F64E919
FLAGS=PF IF
FPU ControlWord=IC RC=NEAR PC=64bits PM UM OM ZM DM IM
FPU StatusWord=
FPU ST(0): 1.000000
```

ST(0) holds the first argument (1) and second one is in [EBX].

The instruction after FDIV (FSTP) writes the result in memory:

```
.text:3011E91B DD 1E          fstp    qword ptr [esi]
```

If we set a breakpoint on it, we can see the result:

```
PID=32852|TID=36488|(0) 0x2f40e91b (Excel.exe!BASE+0x11e91b)
EAX=0x00598006 EBX=0x00598018 ECX=0x00000001 EDX=0x00000001
ESI=0x00598000 EDI=0x00294804 EBP=0x026CF93C ESP=0x026CF8F8
EIP=0x2F40E91B
FLAGS=PF IF
FPU ControlWord=IC RC=NEAR PC=64bits PM UM OM ZM DM IM
FPU StatusWord=C1 P
FPU ST(0): 0.333333
```

Also as a practical joke, we can modify it on the fly:

```
tracer -l:excel.exe bpx=excel.exe!BASE+0x11E91B,set(st0,666)
```

```
PID=36540|TID=24056|(0) 0x2f40e91b (Excel.exe!BASE+0x11e91b)
EAX=0x00680006 EBX=0x00680018 ECX=0x00000001 EDX=0x00000001
ESI=0x00680000 EDI=0x00395404 EBP=0x0290FD9C ESP=0x0290FD58
EIP=0x2F40E91B
FLAGS=PF IF
FPU ControlWord=IC RC=NEAR PC=64bits PM UM OM ZM DM IM
FPU StatusWord=C1 P
FPU ST(0): 0.333333
Set ST0 register to 666.000000
```

Excel shows 666 in the cell, finally convincing us that we have found the right point.

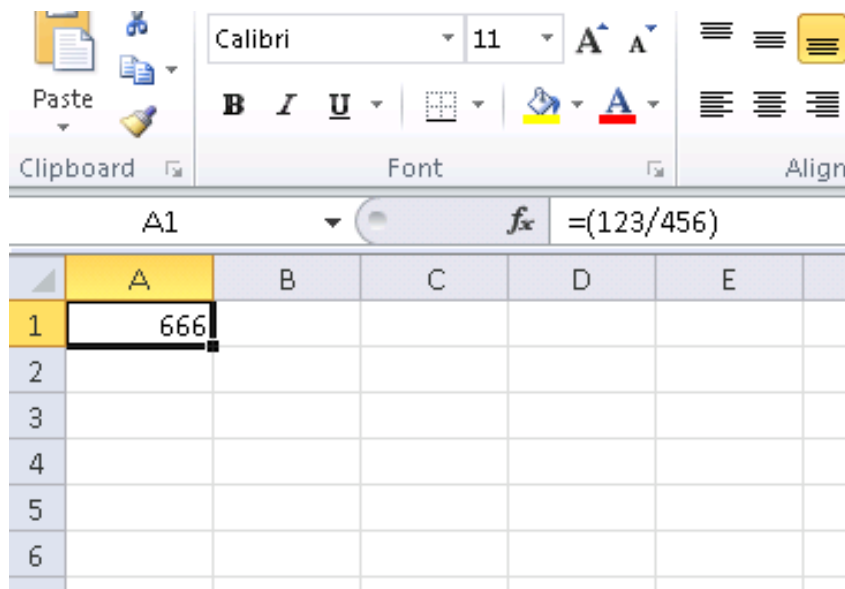

Figure 5.7: The practical joke worked

If we try the same Excel version, but in x64, we will find only 12 FDIV instructions there, and the one we looking for is the third one.

```
tracer.exe -l:excel.exe bpx=excel.exe!BASE+0x1B7FCC,set(st0,666)
```

It seems that a lot of division operations of *float* and *double* types, were replaced by the compiler with SSE instructions like DIVSD (DIVSD is present 268 times in total).

## 5.8 Suspicious code patterns

### 5.8.1 XOR instructions

Instructions like XOR op, op (for example, XOR EAX, EAX) are usually used for setting the register value to zero, but if the operands are different, the “exclusive or” operation is executed.

This operation is rare in common programming, but widespread in cryptography, including amateur one. It’s especially suspicious if the second operand is a big number.

This may point to encrypting/decrypting, checksum computing, etc.

One exception to this observation worth noting is the “canary” ( [1.26.3 on page 281](#)). Its generation and checking are often done using the XOR instruction.

This AWK script can be used for processing IDA listing (.lst) files:

```
gawk -e '$2=="xor" { tmp=substr($3, 0, length($3)-1); if (tmp!=$4) if($4!="esp") if ($4!="ebp") ↵
  { print $1, $2, tmp, ",", $4 } }' filename.lst
```

It is also worth noting that this kind of script can also match incorrectly disassembled code ( [5.11.1 on page 729](#)).

### 5.8.2 Hand-written assembly code

Modern compilers do not emit the L00P and RCL instructions. On the other hand, these instructions are well-known to coders who like to code directly in assembly language. If you spot these, it can be said that there is a high probability that this fragment of code was hand-written. Such instructions are marked as (M) in the instructions list in this appendix: [.1.6 on page 1027](#).

Also the function prologue/epilogue are not commonly present in hand-written assembly.



Commonly there is no fixed system for passing arguments to functions in the hand-written code.

Example from the Windows 2003 kernel (ntoskrnl.exe file):

```
MultiplyTest proc near                ; CODE XREF: Get386Stepping
    xor     cx, cx
loc_620555:                            ; CODE XREF: MultiplyTest+E
    push   cx
    call   Multiply
    pop    cx
    jb     short locret_620563
    loop   loc_620555
    clc
locret_620563:                        ; CODE XREF: MultiplyTest+C
    retn
MultiplyTest endp

Multiply    proc near                ; CODE XREF: MultiplyTest+5
    mov    ecx, 81h
    mov    eax, 417A000h
    mul    ecx
    cmp    edx, 2
    stc
    jnz    short locret_62057F
    cmp    eax, 0FE7A000h
    stc
    jnz    short locret_62057F
    clc
locret_62057F:                        ; CODE XREF: Multiply+10
                                        ; Multiply+18
    retn
Multiply    endp
```

Indeed, if we look in the [WRK<sup>19</sup>](#) v1.2 source code, this code can be found easily in file `WRK-v1.2\base\ntos\ke\i386\cpu.asm`.

As of RCL instruction, I can find it in the ntoskrnl.exe file in Windows 2003 x86 (compiled with MS Visual C compiler). It is occurred only once there, in `RtlExtendedLargeIntegerDivide()` function, and this might be inline assembler code case.

## 5.9 Using magic numbers while tracing

Often, our main goal is to understand how the program uses a value that has been either read from file or received via network. The manual tracing of a value is often a very labor-intensive task. One of the simplest techniques for this (although not 100% reliable) is to use your own *magic number*.

This resembles X-ray computed tomography in some sense: a radiocontrast agent is injected into the patient's blood, which is then used to improve the visibility of the patient's internal structure in to the X-rays. It is well known how the blood of healthy humans percolates in the kidneys and if the agent is in the blood, it can be easily seen on tomography, how blood is percolating, and are there any stones or tumors.

We can take a 32-bit number like `0x0badf00d`, or someone's birth date like `0x11101979` and write this 4-byte number to some point in a file used by the program we investigate.

Then, while tracing this program with [tracer](#) in *code coverage* mode, with the help of *grep* or just by searching in the text file (of tracing results), we can easily see where the value has been used and how.

Example of *grepable tracer* results in *cc* mode:

```
0x150bf66 (_kziaia+0x14), e=      1 [MOV EBX, [EBP+8]] [EBP+8]=0xf59c934
0x150bf69 (_kziaia+0x17), e=      1 [MOV EDX, [69AEB08h]] [69AEB08h]=0
0x150bf6f (_kziaia+0x1d), e=      1 [FS: MOV EAX, [2Ch]]
0x150bf75 (_kziaia+0x23), e=      1 [MOV ECX, [EAX+EDX*4]] [EAX+EDX*4]=0xf1ac360
0x150bf78 (_kziaia+0x26), e=      1 [MOV [EBP-4], ECX] ECX=0xf1ac360
```

<sup>19</sup>Windows Research Kernel

This can be used for network packets as well. It is important for the *magic number* to be unique and not to be present in the program's code.

Aside of the [tracer](#), DosBox (MS-DOS emulator) in heavydebug mode is able to write information about all registers' states for each executed instruction of the program to a plain text file<sup>20</sup>, so this technique may be useful for DOS programs as well.

## 5.10 Loops

Whenever your program works with some kind of file, or buffer of some size, it has to be some kind of decrypting/processing loop inside of the code.

This is a real example of [tracer](#) tool output. There was a code which loads some kind of encrypted file of 258 bytes. I run it with the intention to get each instruction counts (a [DBI](#) tool will serve much better these days). And I quickly found a piece of code, which executed 259/258 times:

```
...
0x45a6b5 e= 1 [FS: MOV [0], EAX] EAX=0x218fb08
0x45a6bb e= 1 [MOV [EBP-254h], ECX] ECX=0x218fbd8
0x45a6c1 e= 1 [MOV EAX, [EBP-254h]] [EBP-254h]=0x218fbd8
0x45a6c7 e= 1 [CMP [EAX+14h], 0] [EAX+14h]=0x102
0x45a6cb e= 1 [JZ 45A9F2h] ZF=false
0x45a6d1 e= 1 [MOV [EBP-0Dh], 1]
0x45a6d5 e= 1 [XOR ECX, ECX] ECX=0x218fbd8
0x45a6d7 e= 1 [MOV [EBP-14h], CX] CX=0
0x45a6db e= 1 [MOV [EBP-18h], 0]
0x45a6e2 e= 1 [JMP 45A6EDh]
0x45a6e4 e= 258 [MOV EDX, [EBP-18h]] [EBP-18h]=0..5 (248 items skipped) 0xfd..0x101
0x45a6e7 e= 258 [ADD EDX, 1] EDX=0..5 (248 items skipped) 0xfd..0x101
0x45a6ea e= 258 [MOV [EBP-18h], EDX] EDX=1..6 (248 items skipped) 0xfe..0x102
0x45a6ed e= 259 [MOV EAX, [EBP-254h]] [EBP-254h]=0x218fbd8
0x45a6f3 e= 259 [MOV ECX, [EBP-18h]] [EBP-18h]=0..5 (249 items skipped) 0xfe..0x102
0x45a6f6 e= 259 [CMP ECX, [EAX+14h]] ECX=0..5 (249 items skipped) 0xfe..0x102 [EAX+14h]=0x102
0x45a6f9 e= 259 [JNB 45A727h] CF=false,true
0x45a6fb e= 258 [MOV EDX, [EBP-254h]] [EBP-254h]=0x218fbd8
0x45a701 e= 258 [MOV EAX, [EDX+10h]] [EDX+10h]=0x21ee4c8
0x45a704 e= 258 [MOV ECX, [EBP-18h]] [EBP-18h]=0..5 (248 items skipped) 0xfd..0x101
0x45a707 e= 258 [ADD ECX, 1] ECX=0..5 (248 items skipped) 0xfd..0x101
0x45a70a e= 258 [IMUL ECX, ECX, 1Fh] ECX=1..6 (248 items skipped) 0xfe..0x102
0x45a70d e= 258 [MOV EDX, [EBP-18h]] [EBP-18h]=0..5 (248 items skipped) 0xfd..0x101
0x45a710 e= 258 [MOVZX EAX, [EAX+EDX]] [EAX+EDX]=1..6 (156 items skipped) 0xf3, 0xf8, 0xf9, 0xfc, 0xfd
    ↪ xfc, 0xfd
0x45a714 e= 258 [XOR EAX, ECX] EAX=1..6 (156 items skipped) 0xf3, 0xf8, 0xf9, 0xfc, 0xfd ECX=0..5 (248 items skipped) 0x1ec2, 0x1ee1, 0x1f00, 0x1f1f, 0x1f3e
    ↪ x1f, 0x3e, 0x5d, 0x7c, 0x9b (248 items skipped) 0x1ec2, 0x1ee1, 0x1f00, 0x1f1f, 0x1f3e
0x45a716 e= 258 [MOV ECX, [EBP-254h]] [EBP-254h]=0x218fbd8
0x45a71c e= 258 [MOV EDX, [ECX+10h]] [ECX+10h]=0x21ee4c8
0x45a71f e= 258 [MOV ECX, [EBP-18h]] [EBP-18h]=0..5 (248 items skipped) 0xfd..0x101
0x45a722 e= 258 [MOV [EDX+ECX], AL] AL=0..5 (77 items skipped) 0xe2, 0xee, 0xef, 0xf7, 0xfc
0x45a725 e= 258 [JMP 45A6E4h]
0x45a727 e= 1 [PUSH 5]
0x45a729 e= 1 [MOV ECX, [EBP-254h]] [EBP-254h]=0x218fbd8
0x45a72f e= 1 [CALL 45B500h]
0x45a734 e= 1 [MOV ECX, EAX] EAX=0x218fbd8
0x45a736 e= 1 [CALL 45B710h]
0x45a73b e= 1 [CMP EAX, 5] EAX=5
...
```

As it turns out, this is the decrypting loop.

### 5.10.1 Some binary file patterns

All examples here were prepared on the Windows with active code page 437 in console. Binary files internally may look visually different if another code page is set.

<sup>20</sup>See also my blog post about this DosBox feature: [blog.yurichev.com](http://blog.yurichev.com)

## Arrays

Sometimes, we can clearly spot an array of 16/32/64-bit values visually, in hex editor.

Here is an example of array of 16-bit values. We see that the first byte in pair is 7 or 8, and the second looks random:

```

E:\...3afffacde09fe21c28f1543db51145b.dat h 1252      2175000      Col 0      23%      21:25
000007CA70: EF 07 C6 07 D6 07 26 08 | 0C 08 CE 07 24 07 60 07 | ï·Æ·Ö·&·ø·Ï·$·`·
000007CA80: CC 07 AA 07 A2 07 AC 07 | E9 07 BF 07 D6 07 2C 08 | Ì·ª·ø·¬·é·¿·Ö·,·
000007CA90: 09 08 CA 07 31 07 5E 07 | BC 07 9A 07 93 07 9E 07 | o·Ë·1·^·%·š·“·ž·
000007CAA0: E6 07 BD 07 D8 07 2F 08 | 06 08 CB 07 3E 07 5E 07 | æ·%·ø·/·↑·Ë·>·^·
000007CAB0: B3 07 91 07 8B 07 97 07 | E1 07 BB 07 DB 07 32 08 | ³·´·<·—·á·»·Û·2·
000007CAC0: 03 08 CB 07 4C 07 61 07 | AA 07 89 07 84 07 91 07 | ♥·Ë·L·a·ª·%·„·´·
000007CAD0: E0 07 BB 07 DC 07 33 08 | 01 08 CC 07 57 07 64 07 | à·»·Û·3·@·Ï·W·d·
000007CAE0: A4 07 84 07 81 07 90 07 | DE 07 BB 07 DE 07 34 08 | ð·„·@·@·þ·»·þ·4·
000007CAF0: FF 07 CD 07 65 07 69 07 | A0 07 81 07 7F 07 90 07 | ÿ·Ï·e·i· @·∆·@·
000007CB00: DE 07 BC 07 DF 07 33 08 | FF 07 CE 07 70 07 6F 07 | þ·%·ß·3·ÿ·Ï·p·o·
000007CB10: 9F 07 82 07 81 07 93 07 | DD 07 BC 07 E0 07 34 08 | Ÿ·„·@·“·Ý·%·à·4·
000007CB20: FE 07 CE 07 7E 07 78 07 | 9F 07 84 07 84 07 96 07 | þ·Ï·~·x·ÿ·„·„·-·
000007CB30: DE 07 BD 07 DF 07 32 08 | FF 07 CE 07 87 07 7F 07 | þ·%·ß·2·ÿ·Ï·‡·∆·
000007CB40: A1 07 87 07 88 07 9B 07 | E2 07 BF 07 DE 07 2F 08 | j·‡·^·>·â·¿·þ·/·
000007CB50: 02 08 CF 07 93 07 89 07 | A4 07 8C 07 8D 07 9F 07 | @·Ï·“·%·ð·(·@·ÿ·
000007CB60: E4 07 C0 07 DD 07 2D 08 | 03 08 CF 07 9C 07 92 07 | ä·À·Ý·-·♥·Ï·æ·’·
000007CB70: A9 07 90 07 91 07 A3 07 | E6 07 C3 07 DD 07 2B 08 | @·@·´·f·æ·Ã·Ý·+·
000007CB80: 04 08 D0 07 A7 07 9C 07 | AE 07 96 07 96 07 A7 07 | ♦·@·§·æ·®·-·-·§·
000007CB90: E8 07 C7 07 DF 07 29 08 | 04 08 D3 07 B1 07 A7 07 | è·Ç·ß·)·♦·@·Ó·±·§·
000007CBA0: B4 07 9B 07 9B 07 AB 07 | E8 07 CA 07 E1 07 27 08 | ^·>·>·«·è·Ë·á·'·
000007CBB0: 03 08 D5 07 BB 07 B3 07 | BB 07 A1 07 A0 07 AF 07 | ♥·Û·»·³·»·j· -·
000007CBC0: EA 07 CD 07 E3 07 25 08 | 03 08 D8 07 C4 07 BD 07 | ê·Ï·ã·%·♥·ø·Ä·%·
000007CBD0: C1 07 A6 07 A5 07 B3 07 | EA 07 D1 07 E6 07 22 08 | Á·!·¥·³·ê·Ñ·æ·"·
000007CBE0: 01 08 DC 07 CE 07 C8 07 | C8 07 AD 07 AA 07 B7 07 | @·Û·Ï·Ë·È·È·-·ª·.·
1Help 2Wrap 3Quit 4Text 5 6Edit 7Search 8OEM 9 10Quit
  
```

Figure 5.8: FAR: array of 16-bit values

I used a file containing 12-channel signal digitized using 16-bit [ADC<sup>21</sup>](#).

<sup>21</sup>Analog-to-Digital Converter

And here is an example of very typical MIPS code.

As we may recall, every MIPS (and also ARM in ARM mode or ARM64) instruction has size of 32 bits (or 4 bytes), so such code is array of 32-bit values.

By looking at this screenshot, we may see some kind of pattern.

Vertical red lines are added for clarity:

```
Hiew: FW96650A.bin
FW96650A.bin          FRO -----          00005000
00005000: A0 B0 02 3C 04 00 BE AF 40 00 43 8C 21 F0 A0 03  a<@ @n@ CM!Ea@
00005010: FF 1F 02 3C 21 E8 C0 03 FF FF 42 34 24 10 62 00  @<!wL@ B4$b
00005020: 00 A0 03 3C 25 10 43 00 04 00 BE 8F 08 00 E0 03  a@%C@ @ @p@
00005030: 08 00 BD 27 F8 FF BD 27 A0 B0 02 3C 04 00 BE AF  @ J'o J'a@<@ @n
00005040: 48 00 43 8C 21 F0 A0 03 FF 1F 02 3C 21 E8 C0 03  H CM!Ea@ @<!wL@
00005050: FF FF 42 34 24 10 62 00 00 A0 03 3C 25 10 43 00  B4$b a@%C
00005060: 04 00 BE 8F 08 00 E0 03 08 00 BD 27 F8 FF BD 27  @ @p@ p@ J'o J'
00005070: 21 10 00 00 04 00 BE AF 08 00 80 14 21 F0 A0 03  !@ @ @n@ A@!Ea@
00005080: A0 B0 03 3C 21 E8 C0 03 44 29 02 7C 3C 00 62 AC  a@<!wL@D@|< bм
00005090: 04 00 BE 8F 08 00 E0 03 08 00 BD 27 01 00 03 24  @ @p@ p@ J'@ @ $
000050A0: 44 29 62 7C A0 B0 03 3C 21 E8 C0 03 3C 00 62 AC  D)b|a@<!wL@< bм
000050B0: 04 00 BE 8F 08 00 E0 03 08 00 BD 27 F8 FF BD 27  @ @p@ p@ J'o J'
000050C0: A0 B0 02 3C 04 00 BE AF 84 00 43 8C 21 F0 A0 03  a@<@ @nD CM!Ea@
000050D0: 21 E8 C0 03 C4 FF 03 7C 84 00 43 AC 04 00 BE 8F  !wL@- @|D Cм@ @P
000050E0: 08 00 E0 03 08 00 BD 27 F8 FF BD 27 A0 B0 02 3C  @ p@ J'o J'a@<
000050F0: 04 00 BE AF 20 00 43 8C 21 F0 A0 03 01 00 04 24  @ @n CM!Ea@ @ $
00005100: 21 E8 C0 03 44 08 83 7C 20 00 43 AC 04 00 BE 8F  !wL@D@Г| Cм@ @P
00005110: 08 00 E0 03 08 00 BD 27 F8 FF BD 27 A0 B0 02 3C  @ p@ J'o J'a@<
00005120: 04 00 BE AF 20 00 43 8C 21 F0 A0 03 21 E8 C0 03  @ @n CM!Ea@!wL@
00005130: 44 08 03 7C 20 00 43 AC 04 00 BE 8F 08 00 E0 03  D@| Cм@ @P@ p@
00005140: 08 00 BD 27 F8 FF BD 27 A0 B0 03 3C 04 00 BE AF  @ J'o J'a@<@ @n
00005150: 10 00 62 8C 01 00 08 24 04 A5 02 7D 08 00 09 24  @ bм@ @e@} @ $
00005160: 10 00 62 AC 04 7B 22 7D 04 48 02 7C 04 84 02 7D  @ bм{" }@H@|@D}
00005170: 10 00 62 AC 21 F0 A0 03 21 18 00 00 A0 B0 0B 3C  @ bм!Ea@!@ a@<
00005180: 51 00 0A 24 02 00 88 94 00 00 89 94 00 44 08 00  Q @ $ @ И@ Й@ D@
00005190: 25 40 09 01 01 00 63 24 14 00 68 AD F9 FF 6A 14  %@ @ @ c $ @ hн· j@
000051A0: 04 00 84 24 21 18 00 00 A0 B0 0A 3C 07 00 09 24  @ D $ !@ a@<@ @ $
000051B0: 02 00 A4 94 00 00 A8 94 00 24 04 00 25 20 88 00  @ д@ и@ $@ % И
1Global 2FilBlk 3CryBlk 4ReLoad 5 6String 7Direct 8Table 9 10Leave 11
```

Figure 5.9: Hiew: very typical MIPS code

Another example of such pattern here is book: [9.5 on page 968](#).

## Sparse files

This is sparse file with data scattered amidst almost empty file. Each space character here is in fact zero byte (which is looks like space). This is a file to program FPGA (Altera Stratix GX device). Of course, files like these can be compressed easily, but formats like this one are very popular in scientific and engineering software where efficient access is important while compactness is not.

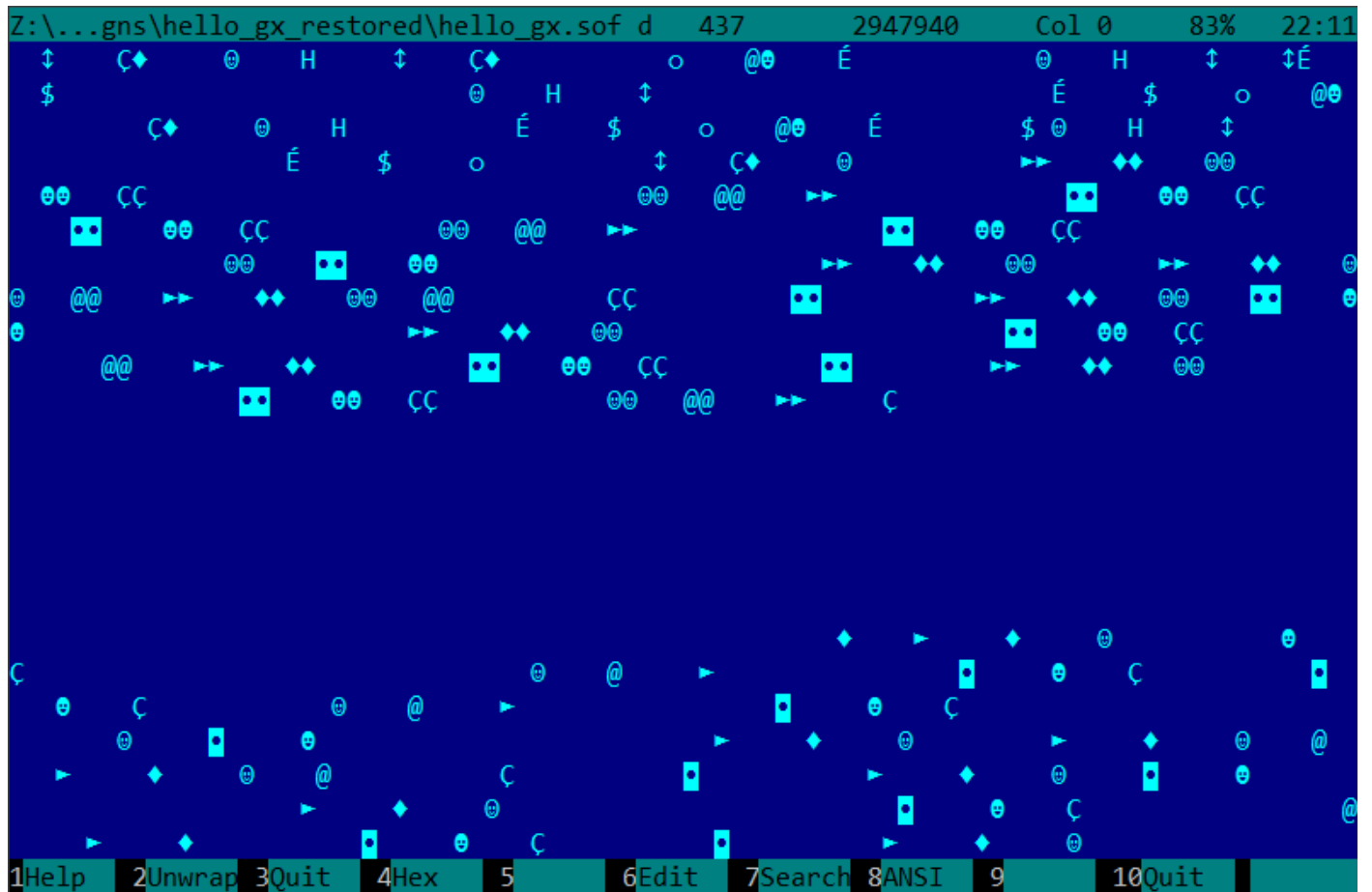

Figure 5.10: FAR: Sparse file

### Compressed file

This file is just some compressed archive. It has relatively high entropy and visually looks just chaotic. This is how compressed and/or encrypted files looks like.

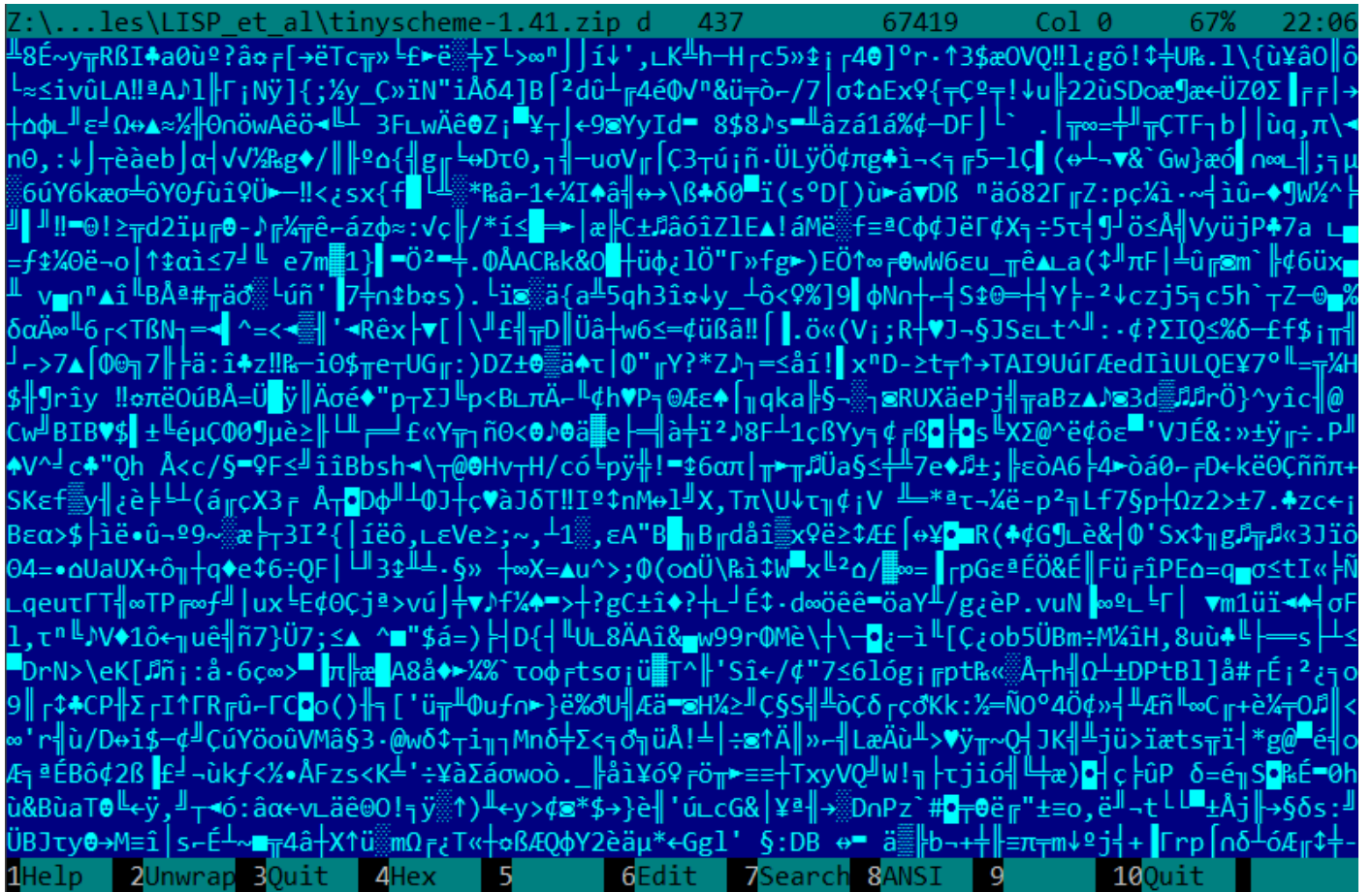

Figure 5.11: FAR: Compressed file

OS installations are usually distributed as ISO files which are copies of CD/DVD discs. Filesystem used is named **CDFS**, here is you see file names mixed with some additional data. This can be file sizes, pointers to another directories, file attributes, etc. This is how typical filesystems may look internally.



Figure 5.12: FAR: ISO file: Ubuntu 15 installation CD<sup>23</sup>

<sup>22</sup>Compact Disc File System

### 32-bit x86 executable code

This is how 32-bit x86 executable code looks like. It has not very high entropy, because some bytes occurred more often than others.



Figure 5.13: FAR: Executable 32-bit x86 code



## BMP graphics files

BMP files are not compressed, so each byte (or group of bytes) describes each pixel. I've found this picture somewhere inside my installed Windows 8.1:



Figure 5.14: Example picture

You see that this picture has some pixels which unlikely can be compressed very good (around center), but there are long one-color lines at top and bottom. Indeed, lines like these also looks as lines during viewing the file:

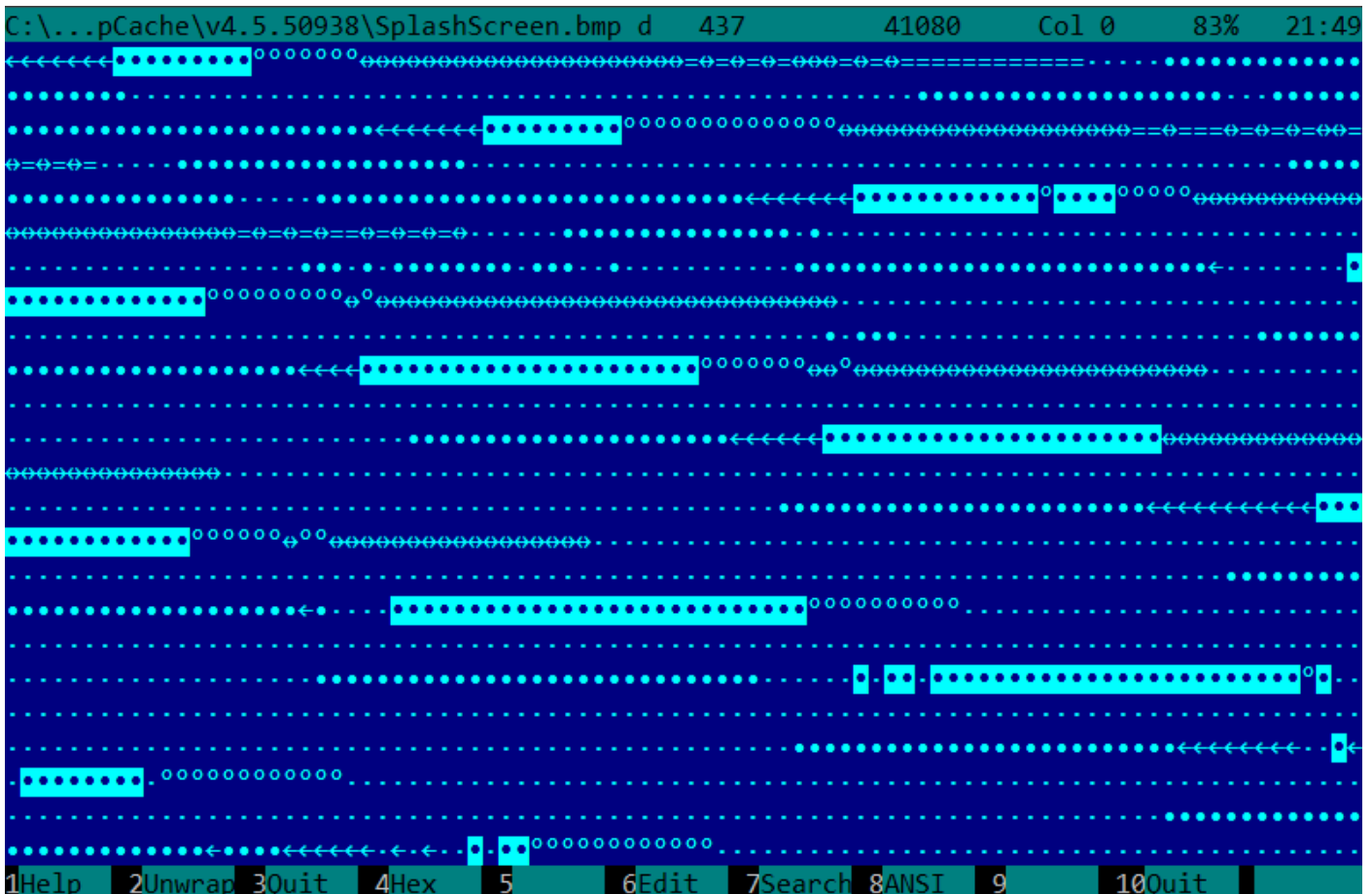

Figure 5.15: BMP file fragment

### 5.10.2 Memory “snapshots” comparing

The technique of the straightforward comparison of two memory snapshots in order to see changes was often used to hack 8-bit computer games and for hacking “high score” files.

For example, if you had a loaded game on an 8-bit computer (there isn't much memory on these, but the game usually consumes even less memory) and you know that you have now, let's say, 100 bullets, you

can do a “snapshot” of all memory and back it up to some place. Then shoot once, the bullet count goes to 99, do a second “snapshot” and then compare both: it must be a byte somewhere which has been 100 at the beginning, and now it is 99.

Considering the fact that these 8-bit games were often written in assembly language and such variables were global, it can be said for sure which address in memory has holding the bullet count. If you searched for all references to the address in the disassembled game code, it was not very hard to find a piece of code [decrementing](#) the bullet count, then to write a [NOP](#) instruction there, or a couple of [NOP](#)-s, and then have a game with 100 bullets forever. Games on these 8-bit computers were commonly loaded at the constant address, also, there were not much different versions of each game (commonly just one version was popular for a long span of time), so enthusiastic gamers knew which bytes must be overwritten (using the BASIC’s instruction [POKE](#)) at which address in order to hack it. This led to “cheat” lists that contained [POKE](#) instructions, published in magazines related to 8-bit games.

Likewise, it is easy to modify “high score” files, this does not work with just 8-bit games. Notice your score count and back up the file somewhere. When the “high score” count gets different, just compare the two files, it can even be done with the DOS utility [FC](#)<sup>24</sup> (“high score” files are often in binary form).

There will be a point where a couple of bytes are different and it is easy to see which ones are holding the score number. However, game developers are fully aware of such tricks and may defend the program against it.

Somewhat similar example in this book is: [9.3 on page 956](#).

### **A real story from 1999**

There was a time of ICQ messenger’s popularity, at least in ex-USSR countries. The messenger had a peculiarity — some users didn’t want to share their online status with everyone. And you had to ask an *authorization* from that user. That user could allow you seeing his/her status, or maybe not.

This is what the author of these lines did:

- Added a user.
- A user appeared in a contact-list, in a “wait for authorization” section.
- Closed ICQ.
- Backed up the ICQ database.
- Loaded ICQ again.
- User *authorized*.
- Closed ICQ and compared two databases.

It turned out: two database differed by only one byte. In the first version: RESU\x03, in the second: RESU\x02. (“RESU”, presumably, means “USER”, i.e., a header of a structure where all the information about user was stored.) That means the information about authorization was stored not at the server, but at the client. Presumably, 2/3 value reflected *authorization* status.

### **Windows registry**

It is also possible to compare the Windows registry before and after a program installation.

It is a very popular method of finding which registry elements are used by the program. Perhaps, this is the reason why the “windows registry cleaner” shareware is so popular.

By the way, this is how to dump Windows registry to text files:

```
reg export HKLM HKLM.reg
reg export HKCU HKCU.reg
reg export HKCR HKCR.reg
reg export HKU HKU.reg
reg export HKCC HKCC.reg
```

They can be compared using diff...

---

<sup>24</sup>MS-DOS utility for comparing binary files

## Engineering software, CADs, etc

If a software uses proprietary files, you can also investigate something here as well. You save file. Then you add a dot or line or another primitive. Save file, compare. Or move dot, save file, compare.

### Blink-comparator

Comparison of files or memory snapshots remind us blink-comparator <sup>25</sup>: a device used by astronomers in past, intended to find moving celestial objects.

Blink-comparator allows to switch quickly between two photographs shot in different time, so astronomer would spot the difference visually.

By the way, Pluto was discovered by blink-comparator in 1930.

## 5.11 ISA detection

Often, you can deal with a binary file for an unknown ISA. Perhaps, easiest way to detect ISA is to try various ones in IDA, objdump or another disassembler.

To achieve this, one should understand a difference between incorrectly disassembled code and correctly one.

### 5.11.1 Incorrectly disassembled code

Practicing reverse engineers often have to deal with incorrectly disassembled code.

#### Disassembling from an incorrect start (x86)

Unlike ARM and MIPS (where any instruction has a length of 2 or 4 bytes), x86 instructions have variable size, so any disassembler that starts in the middle of a x86 instruction may produce incorrect results.

As an example:

```
add    [ebp-31F7Bh], cl
dec    dword ptr [ecx-3277Bh]
dec    dword ptr [ebp-2CF7Bh]
inc    dword ptr [ebx-7A76F33Ch]
fdiv   st(4), st
db 0FFh
dec    dword ptr [ecx-21F7Bh]
dec    dword ptr [ecx-22373h]
dec    dword ptr [ecx-2276Bh]
dec    dword ptr [ecx-22B63h]
dec    dword ptr [ecx-22F4Bh]
dec    dword ptr [ecx-23343h]
jmp    dword ptr [esi-74h]
xchg   eax, ebp
clc
std
db 0FFh
db 0FFh
mov    word ptr [ebp-214h], cs ; <- disassembler finally found right track here
mov    word ptr [ebp-238h], ds
mov    word ptr [ebp-23Ch], es
mov    word ptr [ebp-240h], fs
mov    word ptr [ebp-244h], gs
pushf
pop    dword ptr [ebp-210h]
mov    eax, [ebp+4]
mov    [ebp-218h], eax
lea   eax, [ebp+4]
mov    [ebp-20Ch], eax
mov    dword ptr [ebp-2D0h], 10001h
mov    eax, [eax-4]
mov    [ebp-21Ch], eax
```

<sup>25</sup><http://go.yurichev.com/17348>

```

mov     eax, [ebp+0Ch]
mov     [ebp-320h], eax
mov     eax, [ebp+10h]
mov     [ebp-31Ch], eax
mov     eax, [ebp+4]
mov     [ebp-314h], eax
call    ds:IsDebuggerPresent
mov     edi, eax
lea     eax, [ebp-328h]
push   eax
call    sub_407663
pop     ecx
test   eax, eax
jnz    short loc_402D7B

```

There are incorrectly disassembled instructions at the beginning, but eventually the disassembler gets on the right track.

### How does random noise looks disassembled?

Common properties that can be spotted easily are:

- Unusually big instruction dispersion. The most frequent x86 instructions are PUSH, MOV, CALL, but here we see instructions from all instruction groups: FPU instructions, IN/OUT instructions, rare and system instructions, everything mixed up in one single place.
- Big and random values, offsets and immediates.
- Jumps having incorrect offsets, often jumping in the middle of another instructions.

Listing 5.7: random noise (x86)

```

mov     bl, 0Ch
mov     ecx, 0D38558Dh
mov     eax, ds:2C869A86h
db     67h
mov     dl, 0CCh
insb
movsb
push   eax
xor    [edx-53h], ah
fcom  qword ptr [edi-45A0EF72h]
pop    esp
pop    ss
in     eax, dx
dec    ebx
push   esp
lds   esp, [esi-41h]
retf
rcl   dword ptr [eax], cl
mov   cl, 9Ch
mov   ch, 0DFh
push  cs
insb
mov   esi, 0D9C65E4Dh
imul ebp, [ecx], 66h
pushf
sal   dword ptr [ebp-64h], cl
sub   eax, 0AC433D64h
out   8Ch, eax
pop   ss
sbb  [eax], ebx
aas
xchg  cl, [ebx+ebx*4+14B31Eh]
jecxz short near ptr loc_58+1
xor   al, 0C6h
inc   edx
db   36h
pusha
stosb
test  [ebx], ebx

```

```

sub    al, 0D3h ; 'L'
pop    eax
stosb

loc_58: ; CODE XREF: seg000:0000004A
test   [esi], eax
inc    ebp
das
db     64h
pop    ecx
das
hlt

pop    edx
out    0B0h, al
lods   [esi]
push   ebx
cdq
out    dx, al
sub    al, 0Ah
sti
outsd [edi], edx
add    dword ptr [edx], 96FCBE4Bh
and    eax, 0E537EE4Fh
inc    esp
stosd [edi], eax
cdq
push   ecx
in     al, 0CBh
mov    ds:0D114C45Ch, al
mov    esi, 659D1985h

```

Listing 5.8: random noise (x86-64)

```

lea    esi, [rax+rdx*4+43558D29h]

loc_AF3: ; CODE XREF: seg000:00000000000000B46
rcl    byte ptr [rsi+rax*8+29BB423Ah], 1
lea    ecx, cs:0FFFFFFFB2A6780Fh
mov    al, 96h
mov    ah, 0CEh
push   rsp
lods   byte ptr [esi]

db 2Fh ; /

pop    rsp
db 64h
retf  0E993h

cmp    ah, [rax+4Ah]
movzx  rsi, dword ptr [rbp-25h]
push   4Ah
movzx  rdi, dword ptr [rdi+rdx*8]

db 9Ah

rcr    byte ptr [rax+1Dh], cl
lodsd [rsi], edx
xor    [rbp+6CF20173h], edx
xor    [rbp+66F8B593h], edx
push   rbx
sbb   ch, [rbx-0Fh]
stosd [rdi], ecx
int    87h
db 46h, 4Ch
out    33h, rax
xchg  eax, ebp
test   ecx, ebp
movsd [rdi], rax

```

```

leave
push    rsp

db 16h

xchg   eax, esi
pop    rdi

loc_B3D: ; CODE XREF: seg000:00000000000000B5F
mov     ds:93CA685DF98A90F9h, eax
jnz     short near ptr loc_AF3+6
out     dx, eax
cwde
mov     bh, 5Dh ; ']'
movsb
pop     rbp

```

Listing 5.9: random noise (ARM (ARM mode))

```

BLNE    0xFE16A9D8
BGE     0x1634D0C
SVCCS   0x450685
STRNVT  R5, [PC], #-0x964
LDCGE   p6, c14, [R0], #0x168
STCCSL  p9, c9, [LR], #0x14C
CMNHIP  PC, R10, LSL#22
FLDMIADNV LR!, {D4}
MCR     p5, 2, R2, c15, c6, 4
BLGE    0x1139558
BLGT    0xFF9146E4
STRNEB  R5, [R4], #0xCA2
STMNEIB R5, {R0, R4, R6, R7, R9-SP, PC}
STMIA   R8, {R0, R2-R4, R7, R8, R10, SP, LR}^
STRB    SP, [R8], PC, ROR#18
LDCCS   p9, c13, [R6], #0x1BC
LDRGE   R8, [R9], #0x66E
STRNEB  R5, [R8], #-0x8C3
STCCSL  p15, c9, [R7], #-0x84
RSBLS   LR, R2, R11, ASR LR
SVC GT  0x9B0362
SVC GT  0xA73173
STMNEDB R11!, {R0, R1, R4-R6, R8, R10, R11, SP}
STR     R0, [R3], #-0xCE4
LDCGT   p15, c8, [R1], #0x2CC
LDRCCB  R1, [R11], -R7, ROR#30
BLLT    0xFED9D58C
BL      0x13E60F4
LDMVSIB R3!, {R1, R4-R7}^
USATNE  R10, #7, SP, LSL#11
LDRGEB  LR, [R1], #0xE56
STRPLT  R9, [LR], #0x567
LDRLT   R11, [R1], #-0x29B
SVCNV   0x12DB29
MVNNVS  R5, SP, LSL#25
LDCL    p8, c14, [R12], #-0x288
STCNEL  p2, c6, [R6], #-0xBC!
SVCNV   0x2E5A2F
BLX     0x1A8C97E
TEQGE   R3, #0x1100000
STMLSIA R6, {R3, R6, R10, R11, SP}
BICPLS  R12, R2, #0x5800
BNE     0x7CC408
TEQGE   R2, R4, LSL#20
SUBS    R1, R11, #0x28C
BICVS   R3, R12, R7, ASR R0
LDRMI   R7, [LR], R3, LSL#21
BLMI    0x1A79234
STMVCDB R6, {R0-R3, R6, R7, R10, R11}
EORMI   R12, R6, #0xC5
MCR RCS p1, 0xF, R1, R3, c2

```

Listing 5.10: random noise (ARM (Thumb mode))

```

LSRS    R3, R6, #0x12
LDRH    R1, [R7,#0x2C]
SUBS    R0, #0x55 ; 'U'
ADR     R1, loc_3C
LDR     R2, [SP,#0x218]
CMP     R4, #0x86
SXTB    R7, R4
LDR     R4, [R1,#0x4C]
STR     R4, [R4,R2]
STR     R0, [R6,#0x20]
BGT     0xFFFFFFFF72
LDRH    R7, [R2,#0x34]
LDRSH   R0, [R2,R4]
LDRB    R2, [R7,R2]

```

```

DCB 0x17
DCB 0xED

```

```

STRB    R3, [R1,R1]
STR     R5, [R0,#0x6C]
LDMIA   R3, {R0-R5,R7}
ASRS    R3, R2, #3
LDR     R4, [SP,#0x2C4]
SVC     0xB5
LDR     R6, [R1,#0x40]
LDR     R5, =0xB2C5CA32
STMIA   R6, {R1-R4,R6}
LDR     R1, [R3,#0x3C]
STR     R1, [R5,#0x60]
BCC     0xFFFFFFFF70
LDR     R4, [SP,#0x1D4]
STR     R5, [R5,#0x40]
ORRS    R5, R7

```

```

loc_3C ; DATA XREF: ROM:00000006
B      0xFFFFFFFF98

```

Listing 5.11: random noise (MIPS little endian)

```

lw      $t9, 0xCB3($t5)
sb      $t5, 0x3855($t0)
sltiu   $a2, $a0, -0x657A
ldr     $t4, -0x4D99($a2)
daddi   $s0, $s1, 0x50A4
lw      $s7, -0x2353($s4)
bgtzl   $a1, 0x17C5C

```

```

.byte 0x17
.byte 0xED
.byte 0x4B # K
.byte 0x54 # T

```

```

lwc2    $31, 0x66C5($sp)
lwu     $s1, 0x10D3($a1)
ldr     $t6, -0x204B($zero)
lwc1    $f30, 0x4DBE($s2)
daddiu  $t1, $s1, 0x6BD9
lwu     $s5, -0x2C64($v1)
cop0    0x13D642D
bne     $gp, $t4, 0xFFFF9EF0
lh      $ra, 0x1819($s1)
sdl     $fp, -0x6474($t8)
jal     0x78C0050
ori     $v0, $s2, 0xC634
blez    $gp, 0xFFFEA9D4
swl     $t8, -0x2CD4($s2)
sltui   $a1, $k0, 0x685
sdc1    $f15, 0x5964($at)
sw      $s0, -0x19A6($a1)

```

```
sltiu   $t6, $a3, -0x66AD
lb      $t7, -0x4F6($t3)
sd      $fp, 0x4B02($a1)
```

It is also important to keep in mind that cleverly constructed unpacking and decryption code (including self-modifying) may look like noise as well, but still execute correctly.

### 5.11.2 Correctly disassembled code

Each ISA has a dozen of a most used instructions, all the rest are used much less often.

As of x86, it is interesting to know that the fact that function calls (PUSH/CALL/ADD) and MOV instructions are the most frequently executed pieces of code in almost all programs we use. In other words, CPU is very busy passing information between levels of abstractions, or, it can be said, it's very busy switching between these levels. Regardless type of ISA. This is a cost of splitting problems into several levels of abstractions (so humans could work with them easier).

## 5.12 Other things

### 5.12.1 General idea

A reverse engineer should try to be in programmer's shoes as often as possible. To take his/her viewpoint and ask himself, how would one solve some task the specific case.

### 5.12.2 Order of functions in binary code

All functions located in a single .c or .cpp-file are compiled into corresponding object (.o) file. Later, a linker puts all object files it needs together, not changing order of functions in them. As a consequence, if you see two or more consecutive functions, it means, that they were placed together in a single source code file (unless you're on border of two object files, of course.) This means these functions have something in common, that they are from the same API level, from the same library, etc.

This is a real story from practice: once upon a time, the author searched for Twofish-related functions in a program with CryptoPP library linked, especially encryption/decryption functions. I found the `Twofish::Base::UncheckedSetKey()` function, but not others. After peeking into the `twofish.cpp` source code <sup>26</sup>, it became clear that all functions are located in one module (`twofish.cpp`). So I tried all function that followed `Twofish::Base::UncheckedSetKey()`—as it happened, one was `Twofish::Enc::ProcessAndXorBlock()`, another—`Twofish::Dec::ProcessAndXorBlock()`.

### 5.12.3 Tiny functions

Tiny functions like empty functions ( 1.3 on page 5) or function which returns just "true" (1) or "false" (0) ( 1.4 on page 7) are very common, and almost all decent compilers tend to put only one such function into resulting executable code even if there were several similar functions in source code. So, whenever you see a tiny function consisting just of `mov eax, 1 / ret` which is referenced (and can be called) from many places, which are seems unconnected to each other, this may be a result of such optimization.

### 5.12.4 C++

RTTI ( 3.21.1 on page 561)-data may be also useful for C++ class identification.

### 5.12.5 Crash on purpose

Often you need to know, which function has been executed, and which is not. You can use a debugger, but on exotic architectures there may not be the one, so easiest way is to put there an invalid opcode, or something like INT3 (0xCC). The crash would signal about the very fact this instruction has been executed.

Another example of crashing on purpose: 3.23.4 on page 611.

<sup>26</sup><https://github.com/weidai11/cryptopp/blob/b613522794a7633aa2bd81932a98a0b0a51bc04f/twofish.cpp>



# Chapter 6

## OS-specific

### 6.1 Arguments passing methods (calling conventions)

#### 6.1.1 cdecl

This is the most popular method for passing arguments to functions in the C/C++ languages.

The `gscaller` also must return the value of the `stack pointer` (ESP) to its initial state after the `callee` function exits.

Listing 6.1: cdecl

```
push arg3
push arg2
push arg1
call function
add esp, 12 ; returns ESP
```

#### 6.1.2 stdcall

It's almost the same as `cdecl`, with the exception that the `callee` must set ESP to the initial state by executing the `RET x` instruction instead of `RET`, where  $x = \text{arguments number} * \text{sizeof(int)}$ <sup>1</sup>. The `caller` is not adjusting the `stack pointer`, there are no `add esp, x` instruction.

Listing 6.2: stdcall

```
push arg3
push arg2
push arg1
call function

function:
... do something ...
ret 12
```

The method is ubiquitous in win32 standard libraries, but not in win64 (see below about win64).

For example, we can take the function from [1.90 on page 98](#) and change it slightly by adding the `__stdcall` modifier:

```
int __stdcall f2 (int a, int b, int c)
{
    return a*b+c;
};
```

<sup>1</sup>The size of an `int` type variable is 4 in x86 systems and 8 in x64 systems

It is to be compiled in almost the same way as [1.91 on page 98](#), but you will see `RET 12` instead of `RET`. `SP` is not updated in the [caller](#).

As a consequence, the number of function arguments can be easily deduced from the `RETN n` instruction: just divide  $n$  by 4.

Listing 6.3: MSVC 2010

```
_a$ = 8      ; size = 4
_b$ = 12     ; size = 4
_c$ = 16     ; size = 4
_f2@12 PROC
    push    ebp
    mov     ebp, esp
    mov     eax, DWORD PTR _a$[ebp]
    imul   eax, DWORD PTR _b$[ebp]
    add    eax, DWORD PTR _c$[ebp]
    pop     ebp
    ret     12
_f2@12 ENDP

; ...
    push    3
    push    2
    push    1
    call   _f2@12
    push    eax
    push    OFFSET $SG81369
    call   _printf
    add    esp, 8
```

## Functions with variable number of arguments

`printf()`-like functions are, probably, the only case of functions with a variable number of arguments in C/C++, but it is easy to illustrate an important difference between *cdecl* and *stdcall* with their help. Let's start with the idea that the compiler knows the argument count of each `printf()` function call.

However, the called `printf()`, which is already compiled and located in `MSVCRT.DLL` (if we talk about Windows), does not have any information about how much arguments were passed, however it can determine it from the format string.

Thus, if `printf()` would be a *stdcall* function and restored [stack pointer](#) to its initial state by counting the number of arguments in the format string, this could be a dangerous situation, when one programmer's typo can provoke a sudden program crash. Thus it is not suitable for such functions to use *stdcall*, *cdecl* is better.

### 6.1.3 fastcall

That's the general naming for the method of passing some arguments via registers and the rest via the stack. It worked faster than *cdecl/stdcall* on older CPUs (because of smaller stack pressure). It may not help to gain any significant performance on latest (much more complex) CPUs, however.

It is not standardized, so the various compilers can do it differently. It's a well known caveat: if you have two DLLs and the one uses another one, and they are built by different compilers with different *fastcall* calling conventions, you can expect problems.

Both MSVC and GCC pass the first and second arguments via `ECX` and `EDX` and the rest of the arguments via the stack.

The [stack pointer](#) must be restored to its initial state by the [callee](#) (like in *stdcall*).

Listing 6.4: fastcall

```
push arg3
mov edx, arg2
mov ecx, arg1
call function

function:
```

```
.. do something ..  
ret 4
```

For example, we may take the function from [1.90 on page 98](#) and change it slightly by adding a `__fastcall` modifier:

```
int __fastcall f3 (int a, int b, int c)  
{  
    return a*b+c;  
};
```

Here is how it is to be compiled:

Listing 6.5: Optimizing MSVC 2010 /Ob0

```
_c$ = 8          ; size = 4  
@f3@12 PROC  
; _a$ = ecx  
; _b$ = edx  
    mov     eax, ecx  
    imul   eax, edx  
    add    eax, DWORD PTR _c$[esp-4]  
    ret    4  
@f3@12 ENDP  
  
; ...  
  
    mov     edx, 2  
    push    3  
    lea    ecx, DWORD PTR [edx-1]  
    call   @f3@12  
    push   eax  
    push   OFFSET $SG81390  
    call   _printf  
    add    esp, 8
```

We see that the **callee** returns **SP** by using the `RETN` instruction with an operand.

Which implies that the number of arguments can be deduced easily here as well.

### GCC regparm

It is the evolution of *fastcall*<sup>2</sup> in some sense. With the `-mregparm` option it is possible to set how many arguments are to be passed via registers (3 is the maximum). Thus, the EAX, EDX and ECX registers are to be used.

Of course, if the number the of arguments is less than 3, not all 3 registers are to be used.

The **caller** restores the **stack pointer** to its initial state.

For example, see ( [1.28.1 on page 307](#)).

### Watcom/OpenWatcom

Here it is called “register calling convention”. The first 4 arguments are passed via the EAX, EDX, EBX and ECX registers. All the rest—via the stack.

These functions have an underscore appended to the function name in order to distinguish them from those having a different calling convention.

### 6.1.4 thiscall

This is passing the object’s *this* pointer to the function-method, in C++.

In MSVC, *this* is usually passed in the ECX register.

<sup>2</sup><http://go.yurichev.com/17040>

In GCC, the *this* pointer is passed as the first function-method argument. Thus it will be visible that all functions in assembly code have an extra argument, in comparison with the source code.

For an example, see ( [3.21.1 on page 547](#)).

## 6.1.5 x86-64

### Windows x64

The method of for passing arguments in Win64 somewhat resembles `fastcall`. The first 4 arguments are passed via RCX, RDX, R8 and R9, the rest—via the stack. The *caller* also must prepare space for 32 bytes or 4 64-bit values, so then the *callee* can save there the first 4 arguments. Short functions may use the arguments' values just from the registers, but larger ones may save their values for further use.

The *caller* also must return the *stack pointer* into its initial state.

This calling convention is also used in Windows x86-64 system DLLs (instead of `stdcall` in win32).

Example:

```
#include <stdio.h>

void f1(int a, int b, int c, int d, int e, int f, int g)
{
    printf ("%d %d %d %d %d %d %d\n", a, b, c, d, e, f, g);
};

int main()
{
    f1(1,2,3,4,5,6,7);
};
```

Listing 6.6: MSVC 2012 /Ob

```
$SG2937 DB      '%d %d %d %d %d %d %d', 0aH, 00H

main          PROC
              sub     rsp, 72

              mov     DWORD PTR [rsp+48], 7
              mov     DWORD PTR [rsp+40], 6
              mov     DWORD PTR [rsp+32], 5
              mov     r9d, 4
              mov     r8d, 3
              mov     edx, 2
              mov     ecx, 1
              call    f1

              xor     eax, eax
              add     rsp, 72
              ret     0
main          ENDP

a$ = 80
b$ = 88
c$ = 96
d$ = 104
e$ = 112
f$ = 120
g$ = 128
f1          PROC
$LN3:
              mov     DWORD PTR [rsp+32], r9d
              mov     DWORD PTR [rsp+24], r8d
              mov     DWORD PTR [rsp+16], edx
              mov     DWORD PTR [rsp+8], ecx
              sub     rsp, 72

              mov     eax, DWORD PTR g$[rsp]
              mov     DWORD PTR [rsp+56], eax
              mov     eax, DWORD PTR f$[rsp]
```

```

mov     DWORD PTR [rsp+48], eax
mov     eax, DWORD PTR e$[rsp]
mov     DWORD PTR [rsp+40], eax
mov     eax, DWORD PTR d$[rsp]
mov     DWORD PTR [rsp+32], eax
mov     r9d, DWORD PTR c$[rsp]
mov     r8d, DWORD PTR b$[rsp]
mov     edx, DWORD PTR a$[rsp]
lea     rcx, OFFSET FLAT:$SG2937
call    printf

add     rsp, 72
ret     0
f1     ENDP

```

Here we clearly see how 7 arguments are passed: 4 via registers and the remaining 3 via the stack.

The code of the f1() function's prologue saves the arguments in the "scratch space"—a space in the stack intended exactly for this purpose.

This is arranged so because the compiler cannot be sure that there will be enough registers to use without these 4, which will otherwise be occupied by the arguments until the function's execution end.

The "scratch space" allocation in the stack is the caller's duty.

Listing 6.7: Optimizing MSVC 2012 /0b

```

$SG2777 DB     '%d %d %d %d %d %d %d', 0aH, 00H

a$ = 80
b$ = 88
c$ = 96
d$ = 104
e$ = 112
f$ = 120
g$ = 128
f1     PROC
$LN3:
    sub     rsp, 72

    mov     eax, DWORD PTR g$[rsp]
    mov     DWORD PTR [rsp+56], eax
    mov     eax, DWORD PTR f$[rsp]
    mov     DWORD PTR [rsp+48], eax
    mov     eax, DWORD PTR e$[rsp]
    mov     DWORD PTR [rsp+40], eax
    mov     DWORD PTR [rsp+32], r9d
    mov     r9d, r8d
    mov     r8d, edx
    mov     edx, ecx
    lea     rcx, OFFSET FLAT:$SG2777
    call    printf

    add     rsp, 72
    ret     0
f1     ENDP

main   PROC
    sub     rsp, 72

    mov     edx, 2
    mov     DWORD PTR [rsp+48], 7
    mov     DWORD PTR [rsp+40], 6
    lea     r9d, QWORD PTR [rdx+2]
    lea     r8d, QWORD PTR [rdx+1]
    lea     ecx, QWORD PTR [rdx-1]
    mov     DWORD PTR [rsp+32], 5
    call    f1

    xor     eax, eax
    add     rsp, 72

```

```

main    ret    0
        ENDP

```

If we compile the example with optimizations, it is to be almost the same, but the “scratch space” will not be used, because it won’t be needed.

Also take a look on how MSVC 2012 optimizes the loading of primitive values into registers by using LEA ([.1.6 on page 1029](#)). MOV would be 1 byte longer here (5 instead of 4).

Another example of such thing is: [8.2.1 on page 800](#).

## Windows x64: Passing *this* (C/C++)

The *this* pointer is passed in RCX, the first argument of the method is in RDX, etc. For an example see: [3.21.1 on page 549](#).

## Linux x64

The way arguments are passed in Linux for x86-64 is almost the same as in Windows, but 6 registers are used instead of 4 (RDI, RSI, RDX, RCX, R8, R9) and there is no “scratch space”, although the *callee* may save the register values in the stack, if it needs/wants to.

Listing 6.8: Optimizing GCC 4.7.3

```

.LC0:
.string "%d %d %d %d %d %d %d\n"
f1:
    sub    rsp, 40
    mov    eax, DWORD PTR [rsp+48]
    mov    DWORD PTR [rsp+8], r9d
    mov    r9d, ecx
    mov    DWORD PTR [rsp], r8d
    mov    ecx, esi
    mov    r8d, edx
    mov    esi, OFFSET FLAT:.LC0
    mov    edx, edi
    mov    edi, 1
    mov    DWORD PTR [rsp+16], eax
    xor    eax, eax
    call   __printf_chk
    add    rsp, 40
    ret
main:
    sub    rsp, 24
    mov    r9d, 6
    mov    r8d, 5
    mov    DWORD PTR [rsp], 7
    mov    ecx, 4
    mov    edx, 3
    mov    esi, 2
    mov    edi, 1
    call   f1
    add    rsp, 24
    ret

```

N.B.: here the values are written into the 32-bit parts of the registers (e.g., EAX) but not in the whole 64-bit register (RAX). This is because each write to the low 32-bit part of a register automatically clears the high 32 bits. Supposedly, it was decided in AMD to do so to simplify porting code to x86-64.

### 6.1.6 Return values of *float* and *double* type

In all conventions except in Win64, the values of type *float* or *double* are returned via the FPU register ST(0).

In Win64, the values of *float* and *double* types are returned in the low 32 or 64 bits of the XMM0 register.

## 6.1.7 Modifying arguments

Sometimes, C/C++ programmers (not limited to these PLs, though), may ask, what can happen if they modify the arguments?

The answer is simple: the arguments are stored in the stack, that is where the modification takes place.

The calling functions is not using them after the callee's exit (the author of these lines has never seen any such case in his practice).

```
#include <stdio.h>

void f(int a, int b)
{
    a=a+b;
    printf ("%d\n", a);
};
```

Listing 6.9: MSVC 2012

```
_a$ = 8 ; size = 4
_b$ = 12 ; size = 4
_f PROC
    push    ebp
    mov     ebp, esp
    mov     eax, DWORD PTR _a$[ebp]
    add     eax, DWORD PTR _b$[ebp]
    mov     DWORD PTR _a$[ebp], eax
    mov     ecx, DWORD PTR _a$[ebp]
    push    ecx
    push    OFFSET $SG2938 ; '%d', 0aH
    call   _printf
    add     esp, 8
    pop     ebp
    ret     0
_f ENDP
```

So yes, one can modify the arguments easily. Of course, if it is not *references* in C++ ( [3.21.3 on page 563](#)), and if you don't modify data to which a pointer points to, then the effect will not propagate outside the current function.

Theoretically, after the callee's return, the caller could get the modified argument and use it somehow. Maybe if it is written directly in assembly language.

For example, code like this will be generated by usual C/C++ compiler:

```
push    456 ; will be b
push    123 ; will be a
call    f ; f() modifies its first argument
add     esp, 2*4
```

We can rewrite this code like:

```
push    456 ; will be b
push    123 ; will be a
call    f ; f() modifies its first argument
pop     eax
add     esp, 4
; EAX=1st argument of f() modified in f()
```

Hard to imagine, why anyone would need this, but this is possible in practice. Nevertheless, the C/C++ languages standards don't offer any way to do so.

## 6.1.8 Taking a pointer to function argument

...even more than that, it's possible to take a pointer to the function's argument and pass it to another function:

```
#include <stdio.h>

// located in some other file
void modify_a (int *a);

void f (int a)
{
    modify_a (&a);
    printf ("%d\n", a);
};
```

It's hard to understand how it works until we can see the code:

Listing 6.10: Optimizing MSVC 2010

```
$SG2796 DB    '%d', 0aH, 00H

_a$ = 8
_f      PROC
        lea    eax, DWORD PTR _a$[esp-4] ; just get the address of value in local stack
        push  eax                               ; and pass it to modify_a()
        call  _modify_a
        mov   ecx, DWORD PTR _a$[esp]   ; reload it from the local stack
        push ecx                               ; and pass it to printf()
        push  OFFSET $SG2796             ; '%d'
        call  _printf
        add   esp, 12
        ret   0
_f      ENDP
```

The address of the place in the stack where *a* has been passed is just passed to another function. It modifies the value addressed by the pointer and then `printf()` prints the modified value.

The observant reader might ask, what about calling conventions where the function's arguments are passed in registers?

That's a situation where the *Shadow Space* is used.

The input value is copied from the register to the *Shadow Space* in the local stack, and then this address is passed to the other function:

Listing 6.11: Optimizing MSVC 2012 x64

```
$SG2994 DB    '%d', 0aH, 00H

a$ = 48
f      PROC
        mov    DWORD PTR [rsp+8], ecx   ; save input value in Shadow Space
        sub    rsp, 40
        lea   rcx, QWORD PTR a$[rsp]   ; get address of value and pass it to modify_a()
        call  modify_a
        mov   edx, DWORD PTR a$[rsp]   ; reload value from Shadow Space and pass it to
printf()
        lea   rcx, OFFSET FLAT:$SG2994 ; '%d'
        call  printf
        add   rsp, 40
        ret   0
f      ENDP
```

GCC also stores the input value in the local stack:

Listing 6.12: Optimizing GCC 4.9.1 x64

```
.LC0:
    .string "%d\n"
f:
    sub    rsp, 24
    mov   DWORD PTR [rsp+12], edi   ; store input value to the local stack
    lea  rdi, [rsp+12]             ; take an address of the value and pass it to
modify_a()
    call  modify_a
```



```

    mov     edx, DWORD PTR [rsp+12] ; reload value from the local stack and pass it to
printf()
    mov     esi, OFFSET FLAT:.LC0   ; '%d'
    mov     edi, 1
    xor     eax, eax
    call   __printf_chk
    add     rsp, 24
    ret

```

GCC for ARM64 does the same, but this space is called *Register Save Area* here:

Listing 6.13: Optimizing GCC 4.9.1 ARM64

```

f:
    stp     x29, x30, [sp, -32]!
    add     x29, sp, 0           ; setup FP
    add     x1, x29, 32         ; calculate address of variable in Register Save Area
    str     w0, [x1, -4]!      ; store input value there
    mov     x0, x1             ; pass address of variable to the modify_a()
    bl     modify_a
    ldr     w1, [x29, 28]      ; load value from the variable and pass it to printf()
    adrp   x0, .LC0           ; '%d'
    add     x0, x0, :lo12:.LC0
    bl     printf             ; call printf()
    ldp     x29, x30, [sp], 32
    ret
.LC0:
    .string "%d\n"

```

By the way, a similar usage of the *Shadow Space* is also considered here: [3.17.1 on page 524](#).

### 6.1.9 Python ctypes problem (x86 assembly homework)

A Python ctypes module can call external functions in DLLs, .so's, etc. But calling convention (for 32-bit environment) must be specified explicitly:

"ctypes" exports the \*cdll\*, and on Windows \*windll\* and \*oledll\* objects, for loading dynamic link libraries.

You load libraries by accessing them as attributes of these objects. \*cdll\* loads libraries which export functions using the standard "cdecl" calling convention, while \*windll\* libraries call functions using the "stdcall" calling convention.

( <https://docs.python.org/3/library/ctypes.html> )

In fact, we can modify ctypes module (or any other caller code), so that it will successfully call external cdecl or stdcall functions, without knowledge, which is where. (Number of arguments, however, is to be specified).

This is possible to solve using maybe 5-10 x86 assembly instructions in caller. Try to find out these.

### 6.1.10 Cdecl example: a DLL

Let's back to the fact that this is not very important how to declare the main() function: [1.9.2 on page 33](#).

This is a real story: once upon a time I wanted to replace an original DLL file in some software by mine. First I enumerated names of all DLL exports and made a function in my own replacement DLL for each function in the original DLL, like:

```

void function1 ()
{
    write_to_log ("function1() called\n");
};

```

I wanted to see, which functions are called during run, and when. However, I was in hurry and had no time to deduce arguments count for each function, let alone data types. So each function in my replacement DLL had no argument whatsoever. But everything worked, because all functions had *cdecl* calling convention. (It wouldn't work if functions had *stdcall* calling convention.) It also worked for x64 version.

And then I did a next step: I deduced argument types for some functions. But I made several mistakes, for example, the original function took 3 arguments, but I knew only about 2, etc.

Still, it worked. At the beginning, my replacement DLL just ignored all arguments. Then, it ignored the 3rd argument.

## 6.2 Thread Local Storage

TLS is a data area, specific to each thread. Every thread can store what it needs there. One well-known example is the C standard global variable *errno*.

Multiple threads may simultaneously call functions which return an error code in *errno*, so a global variable will not work correctly here for multi-threaded programs, so *errno* must be stored in the [TLS](#).

In the C++11 standard, a new *thread\_local* modifier was added, showing that each thread has its own version of the variable, it can be initialized, and it is located in the [TLS](#)<sup>3</sup>:

Listing 6.14: C++11

```
#include <iostream>
#include <thread>

thread_local int tmp=3;

int main()
{
    std::cout << tmp << std::endl;
};
```

Compiled in MinGW GCC 4.8.1, but not in MSVC 2012.

If we talk about PE files, in the resulting executable file, the *tmp* variable is to be allocated in the section devoted to the [TLS](#).

### 6.2.1 Linear congruential generator revisited

The pseudorandom number generator we considered earlier [1.29 on page 339](#) has a flaw: it's not thread-safe, because it has an internal state variable which can be read and/or modified in different threads simultaneously.

#### Win32

##### Uninitialized [TLS](#) data

One solution is to add `__declspec( thread )` modifier to the global variable, then it will be allocated in the [TLS](#) (line 9):

```
1 #include <stdint.h>
2 #include <windows.h>
3 #include <winnt.h>
4
5 // from the Numerical Recipes book:
6 #define RNG_a 1664525
7 #define RNG_c 1013904223
8
9 __declspec( thread ) uint32_t rand_state;
10
11 void my_srand (uint32_t init)
```

<sup>3</sup> C11 also has thread support, optional though

```

12 {
13     rand_state=init;
14 }
15
16 int my_rand ()
17 {
18     rand_state=rand_state*RNG_a;
19     rand_state=rand_state+RNG_c;
20     return rand_state & 0x7fff;
21 }
22
23 int main()
24 {
25     my_srand(0x12345678);
26     printf ("%d\n", my_rand());
27 };

```

Hiew shows us that there is a new PE section in the executable file: `.tls`.

Listing 6.15: Optimizing MSVC 2013 x86

```

_TLS    SEGMENT
_rand_state DD  01H DUP (?)
_TLS    ENDS

_DATA   SEGMENT
$SG84851 DB  '%d', 0aH, 00H
_DATA   ENDS
_TEXT   SEGMENT

_init$ = 8      ; size = 4
_my_srand PROC
; FS:0=address of TIB
    mov     eax, DWORD PTR fs:__tls_array ; displayed in IDA as FS:2Ch
; EAX=address of TLS of process
    mov     ecx, DWORD PTR __tls_index
    mov     ecx, DWORD PTR [eax+ecx*4]
; ECX=current TLS segment
    mov     eax, DWORD PTR _init$[esp-4]
    mov     DWORD PTR _rand_state[ecx], eax
    ret     0
_my_srand ENDP

_my_rand PROC
; FS:0=address of TIB
    mov     eax, DWORD PTR fs:__tls_array ; displayed in IDA as FS:2Ch
; EAX=address of TLS of process
    mov     ecx, DWORD PTR __tls_index
    mov     ecx, DWORD PTR [eax+ecx*4]
; ECX=current TLS segment
    imul   eax, DWORD PTR _rand_state[ecx], 1664525
    add    eax, 1013904223 ; 3c6ef35fH
    mov    DWORD PTR _rand_state[ecx], eax
    and    eax, 32767 ; 00007fffH
    ret    0
_my_rand ENDP

_TEXT   ENDS

```

`rand_state` is now in the `TLS` segment, and each thread has its own version of this variable.

Here is how it's accessed: load the address of the `TIB` from `FS:2Ch`, then add an additional index (if needed), then calculate the address of the `TLS` segment.

Then it's possible to access the `rand_state` variable through the `ECX` register, which points to a unique area in each thread.

The `FS`: selector is familiar to every reverse engineer, it is specially used to always point to `TIB`, so it would be fast to load the thread-specific data.

The `GS`: selector is used in Win64 and the address of the `TLS` is `0x58`:

Listing 6.16: Optimizing MSVC 2013 x64

```

_TLS   SEGMENT
rand_state DD   01H DUP (?)
_TLS   ENDS

_DATA  SEGMENT
$SG85451 DB   '%d', 0aH, 00H
_DATA  ENDS

_TEXT  SEGMENT

init$ = 8
my_srand PROC
    mov     edx, DWORD PTR _tls_index
    mov     rax, QWORD PTR gs:88 ; 58h
    mov     r8d, OFFSET FLAT:rand_state
    mov     rax, QWORD PTR [rax+rdx*8]
    mov     DWORD PTR [r8+rax], ecx
    ret     0
my_srand ENDP

my_rand PROC
    mov     rax, QWORD PTR gs:88 ; 58h
    mov     ecx, DWORD PTR _tls_index
    mov     edx, OFFSET FLAT:rand_state
    mov     rcx, QWORD PTR [rax+rcx*8]
    imul   eax, DWORD PTR [rcx+rdx], 1664525 ; 0019660dH
    add    eax, 1013904223 ; 3c6ef35fH
    mov     DWORD PTR [rcx+rdx], eax
    and    eax, 32767 ; 00007fffH
    ret     0
my_rand ENDP

_TEXT  ENDS

```

### Initialized TLS data

Let's say, we want to set some fixed value to `rand_state`, so in case the programmer forgets to, the `rand_state` variable would be initialized to some constant anyway (line 9):

```

1 #include <stdint.h>
2 #include <windows.h>
3 #include <winnt.h>
4
5 // from the Numerical Recipes book:
6 #define RNG_a 1664525
7 #define RNG_c 1013904223
8
9 __declspec( thread ) uint32_t rand_state=1234;
10
11 void my_srand (uint32_t init)
12 {
13     rand_state=init;
14 }
15
16 int my_rand ()
17 {
18     rand_state=rand_state*RNG_a;
19     rand_state=rand_state+RNG_c;
20     return rand_state & 0x7fff;
21 }
22
23 int main()
24 {
25     printf ("%d\n", my_rand());
26 };

```

The code is not different from what we already saw, but in IDA we see:

```
.tls:00404000 ; Segment type: Pure data
.tls:00404000 ; Segment permissions: Read/Write
.tls:00404000 _tls          segment para public 'DATA' use32
.tls:00404000          assume cs:_tls
.tls:00404000          ;org 404000h
.tls:00404000 TlsStart      db    0          ; DATA XREF: .rdata:TlsDirectory
.tls:00404001          db    0
.tls:00404002          db    0
.tls:00404003          db    0
.tls:00404004          dd 1234
.tls:00404008 TlsEnd        db    0          ; DATA XREF: .rdata:TlsEnd_ptr
...
```

1234 is there and every time a new thread starts, a new [TLS](#) is allocated for it, and all this data, including 1234, will be copied there.

This is a typical scenario:

- Thread A is started. A [TLS](#) is created for it, 1234 is copied to `rand_state`.
- The `my_rand()` function is called several times in thread A. `rand_state` is different from 1234.
- Thread B is started. A [TLS](#) is created for it, 1234 is copied to `rand_state`, while thread A has a different value in the same variable.

## TLS callbacks

But what if the variables in the [TLS](#) have to be filled with some data that must be prepared in some unusual way?

Let's say, we've got the following task: the programmer can forget to call the `my_srand()` function to initialize the [PRNG](#), but the generator has to be initialized at start with something truly random, instead of 1234. This is a case in which [TLS](#) callbacks can be used.

The following code is not very portable due to the hack, but nevertheless, you get the idea.

What we do here is define a function (`tls_callback()`) which is to be called *before* the process and/or thread start.

The function initializes the [PRNG](#) with the value returned by `GetTickCount()` function.

```
#include <stdint.h>
#include <windows.h>
#include <winnt.h>

// from the Numerical Recipes book:
#define RNG_a 1664525
#define RNG_c 1013904223

__declspec( thread ) uint32_t rand_state;

void my_srand (uint32_t init)
{
    rand_state=init;
}

void WINAPI tls_callback(PVOID a, DWORD dwReason, PVOID b)
{
    my_srand (GetTickCount());
}

#pragma data_seg(".CRT$XLB")
PIMAGE_TLS_CALLBACK p_thread_callback = tls_callback;
#pragma data_seg()

int my_rand ()
{
    rand_state=rand_state*RNG_a;
    rand_state=rand_state+RNG_c;
}
```

```

        return rand_state & 0x7fff;
    }

int main()
{
    // rand_state is already initialized at the moment (using GetTickCount())
    printf ("%d\n", my_rand());
};

```

Let's see it in IDA:

Listing 6.17: Optimizing MSVC 2013

```

.text:00401020 TlsCallback_0  proc near          ; DATA XREF: .rdata:TlsCallbacks
.text:00401020                call     ds:GetTickCount
.text:00401026                push    eax
.text:00401027                call   my_srand
.text:0040102C                pop     ecx
.text:0040102D                retn   0Ch
.text:0040102D TlsCallback_0  endp

...

.rdata:004020C0 TlsCallbacks  dd offset TlsCallback_0 ; DATA XREF: .rdata:TlsCallbacks_ptr

...

.rdata:00402118 TlsDirectory  dd offset TlsStart
.rdata:0040211C TlsEnd_ptr    dd offset TlsEnd
.rdata:00402120 TlsIndex_ptr   dd offset TlsIndex
.rdata:00402124 TlsCallbacks_ptr dd offset TlsCallbacks
.rdata:00402128 TlsSizeOfZeroFill dd 0
.rdata:0040212C TlsCharacteristics dd 300000h

```

TLS callback functions are sometimes used in unpacking routines to obscure their processing. Some people may be confused and be in the dark that some code executed right before the [OEP](#)<sup>4</sup>.

## Linux

Here is how a thread-local global variable is declared in GCC:

```
__thread uint32_t rand_state=1234;
```

This is not the standard C/C++ modifier, but a rather GCC-specific one <sup>5</sup>.

The GS: selector is also used to access the [TLS](#), but in a somewhat different way:

Listing 6.18: Optimizing GCC 4.8.1 x86

```

.text:08048460 my_srand      proc near
.text:08048460                = dword ptr 4
.text:08048460                mov     eax, [esp+arg_0]
.text:08048464                mov     gs:0FFFFFFFCh, eax
.text:0804846A                retn
.text:0804846A my_srand      endp

.text:08048470 my_rand      proc near
.text:08048470                imul   eax, gs:0FFFFFFFCh, 19660Dh
.text:0804847B                add     eax, 3C6EF35Fh
.text:08048480                mov     gs:0FFFFFFFCh, eax
.text:08048486                and     eax, 7FFFh
.text:0804848B                retn
.text:0804848B my_rand      endp

```

<sup>4</sup>Original Entry Point

<sup>5</sup><http://go.yurichev.com/17062>

More about it: [Ulrich Drepper, *ELF Handling For Thread-Local Storage*, (2013)]<sup>6</sup>.

## 6.3 System calls (syscall-s)

As we know, all running processes inside an OS are divided into two categories: those having full access to the hardware (“kernel space”) and those that do not (“user space”).

The OS kernel and usually the drivers are in the first category.

All applications are usually in the second category.

For example, Linux kernel is in *kernel space*, but Glibc in *user space*.

This separation is crucial for the safety of the OS: it is very important not to give to any process the possibility to screw up something in other processes or even in the OS kernel. On the other hand, a failing driver or error inside the OS’s kernel usually leads to a kernel panic or BSOD<sup>7</sup>.

The protection in the x86 processors allows to separate everything into 4 levels of protection (rings), but both in Linux and in Windows only two are used: ring0 (“kernel space”) and ring3 (“user space”).

System calls (syscall-s) are a point where these two areas are connected.

It can be said that this is the main API provided to applications.

As in *Windows NT*, the syscalls table resides in the SSDT<sup>8</sup>.

The usage of syscalls is very popular among shellcode and computer viruses authors, because it is hard to determine the addresses of needed functions in the system libraries, but it is easier to use syscalls. However, much more code has to be written due to the lower level of abstraction of the API.

It is also worth noting that the syscall numbers may be different in various OS versions.

### 6.3.1 Linux

In Linux, a syscall is usually called via `int 0x80`. The call’s number is passed in the EAX register, and any other parameters —in the other registers.

Listing 6.19: A simple example of the usage of two syscalls

```
section .text
global _start

_start:
    mov     edx,len ; buffer len
    mov     ecx,msg ; buffer
    mov     ebx,1   ; file descriptor. 1 is for stdout
    mov     eax,4   ; syscall number. 4 is for sys_write
    int     0x80

    mov     eax,1   ; syscall number. 1 is for sys_exit
    int     0x80

section .data
msg     db 'Hello, world!',0xa
len     equ $ - msg
```

Compilation:

```
nasm -f elf32 1.s
ld 1.o
```

The full list of syscalls in Linux: <http://go.yurichev.com/17319>.

For system calls interception and tracing in Linux, `strace`( 7.2.3 on page 792) can be used.

<sup>6</sup>Also available as <http://go.yurichev.com/17272>

<sup>7</sup>Blue Screen of Death

<sup>8</sup>System Service Dispatch Table

## 6.3.2 Windows

Here they are called via `int 0x2e` or using the special x86 instruction `SYSENTER`.

The full list of syscalls in Windows: <http://go.yurichev.com/17320>.

Further reading:

“Windows Syscall Shellcode” by Piotr Bania: <http://go.yurichev.com/17321>.

## 6.4 Linux

### 6.4.1 Position-independent code

While analyzing Linux shared (.so) libraries, one may frequently spot this code pattern:

Listing 6.20: `libc-2.17.so x86`

```
.text:0012D5E3 __x86_get_pc_thunk_bx proc near ; CODE XREF: sub_17350+3
.text:0012D5E3 ; sub_173CC+4 ...
.text:0012D5E3     mov     ebx, [esp+0]
.text:0012D5E6     retn
.text:0012D5E6 __x86_get_pc_thunk_bx endp

...

.text:000576C0 sub_576C0     proc near ; CODE XREF: tmpfile+73

...

.text:000576C0     push   ebp
.text:000576C1     mov    ecx, large gs:0
.text:000576C8     push   edi
.text:000576C9     push   esi
.text:000576CA     push   ebx
.text:000576CB     call  __x86_get_pc_thunk_bx
.text:000576D0     add   ebx, 157930h
.text:000576D6     sub   esp, 9Ch

...

.text:000579F0     lea   eax, (a__gen_tempname - 1AF000h)[ebx] ; "__gen_tempname"
.text:000579F6     mov   [esp+0ACh+var_A0], eax
.text:000579FA     lea   eax, (a__SysdepsPosix - 1AF000h)[ebx] ;
    "../sysdeps/posix/tempname.c"
.text:00057A00     mov   [esp+0ACh+var_A8], eax
.text:00057A04     lea   eax, (aInvalidKindIn_ - 1AF000h)[ebx] ;
    "! \"invalid KIND in __gen_tempname\""
.text:00057A0A     mov   [esp+0ACh+var_A4], 14Ah
.text:00057A12     mov   [esp+0ACh+var_AC], eax
.text:00057A15     call  __assert_fail
```

All pointers to strings are corrected by some constants and the value in `EBX`, which is calculated at the beginning of each function.

This is the so-called **PIC**, it is intended to be executable if placed at any random point of memory, that is why it cannot contain any absolute memory addresses.

**PIC** was crucial in early computer systems and is still crucial today in embedded systems without virtual memory support (where all processes are placed in a single continuous memory block).

It is also still used in \*NIX systems for shared libraries, since they are shared across many processes while loaded in memory only once. But all these processes can map the same shared library at different addresses, so that is why a shared library has to work correctly without using any absolute addresses.

Let's do a simple experiment:

```
#include <stdio.h>

int global_variable=123;
```



```

int f1(int var)
{
    int rt=global_variable+var;
    printf ("returning %d\n", rt);
    return rt;
};

```

Let's compile it in GCC 4.7.3 and see the resulting .so file in [IDA](#):

```
gcc -fPIC -shared -O3 -o 1.so 1.c
```

Listing 6.21: GCC 4.7.3

```

.text:00000440          public __x86_get_pc_thunk_bx
.text:00000440 __x86_get_pc_thunk_bx proc near          ; CODE XREF: _init_proc+4
.text:00000440                                         ; deregister_tm_clones+4 ...
.text:00000440          mov     ebx, [esp+0]
.text:00000443          retn
.text:00000443 __x86_get_pc_thunk_bx endp

.text:00000570          public f1
.text:00000570 f1          proc near
.text:00000570
.text:00000570 var_1C      = dword ptr -1Ch
.text:00000570 var_18      = dword ptr -18h
.text:00000570 var_14      = dword ptr -14h
.text:00000570 var_8       = dword ptr -8
.text:00000570 var_4       = dword ptr -4
.text:00000570 arg_0       = dword ptr 4
.text:00000570
.text:00000570          sub     esp, 1Ch
.text:00000573          mov     [esp+1Ch+var_8], ebx
.text:00000577          call   __x86_get_pc_thunk_bx
.text:0000057C          add     ebx, 1A84h
.text:00000582          mov     [esp+1Ch+var_4], esi
.text:00000586          mov     eax, ds:(global_variable_ptr - 2000h)[ebx]
.text:0000058C          mov     esi, [eax]
.text:0000058E          lea    eax, (aReturningD - 2000h)[ebx] ; "returning %d\n"
.text:00000594          add     esi, [esp+1Ch+arg_0]
.text:00000598          mov     [esp+1Ch+var_18], eax
.text:0000059C          mov     [esp+1Ch+var_1C], 1
.text:000005A3          mov     [esp+1Ch+var_14], esi
.text:000005A7          call   ___printf_chk
.text:000005AC          mov     eax, esi
.text:000005AE          mov     ebx, [esp+1Ch+var_8]
.text:000005B2          mov     esi, [esp+1Ch+var_4]
.text:000005B6          add     esp, 1Ch
.text:000005B9          retn
.text:000005B9 f1          endp

```

That's it: the pointers to «*returning %d\n*» and *global\_variable* are to be corrected at each function execution.

The `__x86_get_pc_thunk_bx()` function returns in EBX the address of the point after a call to itself (0x57C here).

That's a simple way to get the value of the program counter (EIP) at some point. The 0x1A84 constant is related to the difference between this function's start and the so-called *Global Offset Table Procedure Linkage Table* (GOT PLT), the section right after the *Global Offset Table* (GOT), where the pointer to *global\_variable* is. [IDA](#) shows these offsets in their processed form to make them easier to understand, but in fact the code is:

```

.text:00000577          call   __x86_get_pc_thunk_bx
.text:0000057C          add     ebx, 1A84h
.text:00000582          mov     [esp+1Ch+var_4], esi
.text:00000586          mov     eax, [ebx-0Ch]

```

```
.text:0000058C      mov     esi, [eax]
.text:0000058E      lea    eax, [ebx-1A30h]
```

Here EBX points to the GOT PLT section and to calculate a pointer to *global\_variable* (which is stored in the GOT), 0xC must be subtracted.

To calculate pointer to the «*returning %d\n*» string, 0x1A30 must be subtracted.

By the way, that is the reason why the AMD64 instruction set supports RIP<sup>9</sup>-relative addressing — to simplify PIC-code.

Let's compile the same C code using the same GCC version, but for x64.

IDA would simplify the resulting code but would suppress the RIP-relative addressing details, so we are going to use *objdump* instead of IDA to see everything:

```
0000000000000720 <f1>:
720:  48 8b 05 b9 08 20 00      mov     rax,QWORD PTR [rip+0x2008b9]      ;
      200fe0 <_DYNAMIC+0x1d0>
727:  53                       push    rbx
728:  89 fb                     mov     ebx,edi
72a:  48 8d 35 20 00 00 00      lea    rsi,[rip+0x20]      ; 751 <_fini+0x9>
731:  bf 01 00 00 00           mov     edi,0x1
736:  03 18                     add     ebx,DWORD PTR [rax]
738:  31 c0                     xor     eax,eax
73a:  89 da                     mov     edx,ebx
73c:  e8 df fe ff ff          call   620 <__printf_chk@plt>
741:  89 d8                     mov     eax,ebx
743:  5b                       pop     rbx
744:  c3                       ret
```

0x2008b9 is the difference between the address of the instruction at 0x720 and *global\_variable*, and 0x20 is the difference between the address of the instruction at 0x72A and the «*returning %d\n*» string.

As you might see, the need to recalculate addresses frequently makes execution slower (it is better in x64, though).

So it is probably better to link statically if you care about performance [see: Agner Fog, *Optimizing software in C++* (2015)].

## Windows

The PIC mechanism is not used in Windows DLLs. If the Windows loader needs to load DLL on another base address, it “patches” the DLL in memory (at the *FIXUP* places) in order to correct all addresses.

This implies that several Windows processes cannot share an once loaded DLL at different addresses in different process' memory blocks — since each instance that's loaded in memory is *fixed* to work only at these addresses..

### 6.4.2 LD\_PRELOAD hack in Linux

This allows us to load our own dynamic libraries before others, even before system ones, like *libc.so.6*.

This, in turn, allows us to “substitute” our written functions before the original ones in the system libraries. For example, it is easy to intercept all calls to *time()*, *read()*, *write()*, etc.

Let's see if we can fool the *uptime* utility. As we know, it tells how long the computer has been working. With the help of *strace* (7.2.3 on page 792), it is possible to see that the utility takes this information the */proc/uptime* file:

```
$ strace uptime
...
open("/proc/uptime", O_RDONLY) = 3
lseek(3, 0, SEEK_SET) = 0
read(3, "416166.86 414629.38\n", 2047) = 20
...
```

<sup>9</sup>program counter in AMD64

It is not a real file on disk, it is a virtual one and its contents are generated on fly in the Linux kernel. There are just two numbers:

```
$ cat /proc/uptime
416690.91 415152.03
```

What we can learn from Wikipedia <sup>10</sup>:

The first number is the total number of seconds the system has been up. The second number is how much of that time the machine has spent idle, in seconds.

Let's try to write our own dynamic library with the `open()`, `read()`, `close()` functions working as we need.

At first, our `open()` will compare the name of the file to be opened with what we need and if it is so, it will write down the descriptor of the file opened.

Second, `read()`, if called for this file descriptor, will substitute the output, and in the rest of the cases will call the original `read()` from `libc.so.6`. And also `close()`, will note if the file we are currently following is to be closed.

We are going to use the `dlopen()` and `dlsym()` functions to determine the original function addresses in `libc.so.6`.

We need them because we must pass control to the "real" functions.

On the other hand, if we intercepted `strcmp()` and monitored each string comparisons in the program, then we would have to implement our version of `strcmp()`, and not use the original function <sup>11</sup>, that would be easier.

```
#include <stdio.h>
#include <stdarg.h>
#include <stdlib.h>
#include <stdbool.h>
#include <unistd.h>
#include <dlfcn.h>
#include <string.h>

void *libc_handle = NULL;
int (*open_ptr)(const char *, int) = NULL;
int (*close_ptr)(int) = NULL;
ssize_t (*read_ptr)(int, void*, size_t) = NULL;

bool initied = false;

_Noreturn void die (const char * fmt, ...)
{
    va_list va;
    va_start (va, fmt);

    vprintf (fmt, va);
    exit(0);
};

static void find_original_functions ()
{
    if (initied)
        return;

    libc_handle = dlopen ("libc.so.6", RTLD_LAZY);
    if (libc_handle==NULL)
        die ("can't open libc.so.6\n");

    open_ptr = dlsym (libc_handle, "open");
    if (open_ptr==NULL)
        die ("can't find open()\n");
}
```

<sup>10</sup><https://en.wikipedia.org/wiki/Uptime>

<sup>11</sup>For example, here is how simple `strcmp()` interception works in this article <sup>12</sup> written by Yong Huang

```

    close_ptr = dlsym (libc_handle, "close");
    if (close_ptr==NULL)
        die ("can't find close()\n");

    read_ptr = dlsym (libc_handle, "read");
    if (read_ptr==NULL)
        die ("can't find read()\n");

    initied = true;
}

static int opened_fd=0;

int open(const char *pathname, int flags)
{
    find_original_functions();

    int fd>(*open_ptr)(pathname, flags);
    if (strcmp(pathname, "/proc/uptime")==0)
        opened_fd=fd; // that's our file! record its file descriptor
    else
        opened_fd=0;
    return fd;
};

int close(int fd)
{
    find_original_functions();

    if (fd==opened_fd)
        opened_fd=0; // the file is not opened anymore
    return (*close_ptr)(fd);
};

ssize_t read(int fd, void *buf, size_t count)
{
    find_original_functions();

    if (opened_fd!=0 && fd==opened_fd)
    {
        // that's our file!
        return sprintf (buf, count, "%d %d", 0x7fffffff, 0x7fffffff)+1;
    };
    // not our file, go to real read() function
    return (*read_ptr)(fd, buf, count);
};

```

( [Source code](#) )

Let's compile it as common dynamic library:

```
gcc -fPIC -shared -Wall -o fool_uptime.so fool_uptime.c -ldl
```

Let's run *uptime* while loading our library before the others:

```
LD_PRELOAD=`pwd`/fool_uptime.so uptime
```

And we see:

```
01:23:02 up 24855 days,  3:14,  3 users,  load average: 0.00, 0.01, 0.05
```

If the *LD\_PRELOAD*

environment variable always points to the filename and path of our library, it is to be loaded for all starting programs.

More examples:

- Very simple interception of the strcmp() (Yong Huang) <http://go.yurichev.com/17143>
- Kevin Pulo—Fun with LD\_PRELOAD. A lot of examples and ideas. [yurichev.com](http://yurichev.com)
- File functions interception for compression/decompression files on fly (zlibc). <http://go.yurichev.com/17146>

## 6.5 Windows NT

### 6.5.1 CRT (win32)

Does the program execution start right at the main() function? No, it does not.

If we would open any executable file in IDA or HIEW, we can see OEP pointing to some another code block.

This code is doing some maintenance and preparations before passing control flow to our code. It is called startup-code or CRT code (C RunTime).

The main() function takes an array of the arguments passed on the command line, and also one with environment variables. But in fact a generic string is passed to the program, the CRT code finds the spaces in it and cuts it in parts. The CRT code also prepares the environment variables array envp.

As for GUI<sup>13</sup> win32 applications, WinMain is used instead of main(), having its own arguments:

```
int CALLBACK WinMain(  
    _In_ HINSTANCE hInstance,  
    _In_ HINSTANCE hPrevInstance,  
    _In_ LPSTR lpCmdLine,  
    _In_ int nCmdShow  
);
```

The CRT code prepares them as well.

Also, the number returned by the main() function is the exit code.

It may be passed in CRT to the ExitProcess() function, which takes the exit code as an argument.

Usually, each compiler has its own CRT code.

Here is a typical CRT code for MSVC 2008.

```
1  __tmainCRTStartup proc near  
2  
3  var_24 = dword ptr -24h  
4  var_20 = dword ptr -20h  
5  var_1C = dword ptr -1Ch  
6  ms_exc = CPPEH_RECORD ptr -18h  
7  
8      push    14h  
9      push    offset stru_4092D0  
10     call    __SEH_prolog4  
11     mov     eax, 5A4Dh  
12     cmp     ds:400000h, ax  
13     jnz     short loc_401096  
14     mov     eax, ds:40003Ch  
15     cmp     dword ptr [eax+400000h], 4550h  
16     jnz     short loc_401096  
17     mov     ecx, 10Bh  
18     cmp     [eax+400018h], cx  
19     jnz     short loc_401096  
20     cmp     dword ptr [eax+400074h], 0Eh  
21     jbe     short loc_401096  
22     xor     ecx, ecx  
23     cmp     [eax+4000E8h], ecx
```

<sup>13</sup>Graphical User Interface

```

24     setnz    cl
25     mov     [ebp+var_1C], ecx
26     jmp     short loc_40109A
27
28
29 loc_401096: ; CODE XREF: ___tmainCRTStartup+18
30             ; ___tmainCRTStartup+29 ...
31     and     [ebp+var_1C], 0
32
33 loc_40109A: ; CODE XREF: ___tmainCRTStartup+50
34     push    1
35     call    __heap_init
36     pop     ecx
37     test   eax, eax
38     jnz    short loc_4010AE
39     push   1Ch
40     call   _fast_error_exit
41     pop    ecx
42
43 loc_4010AE: ; CODE XREF: ___tmainCRTStartup+60
44     call   __mtinit
45     test   eax, eax
46     jnz    short loc_4010BF
47     push   10h
48     call   _fast_error_exit
49     pop    ecx
50
51 loc_4010BF: ; CODE XREF: ___tmainCRTStartup+71
52     call   sub_401F2B
53     and    [ebp+ms_exc.disabled], 0
54     call   __ioinit
55     test   eax, eax
56     jge    short loc_4010D9
57     push   1Bh
58     call   __amsg_exit
59     pop    ecx
60
61 loc_4010D9: ; CODE XREF: ___tmainCRTStartup+8B
62     call   ds:GetCommandLineA
63     mov    dword_40B7F8, eax
64     call   ___crtGetEnvironmentStringsA
65     mov    dword_40AC60, eax
66     call   __setargv
67     test   eax, eax
68     jge    short loc_4010FF
69     push   8
70     call   __amsg_exit
71     pop    ecx
72
73 loc_4010FF: ; CODE XREF: ___tmainCRTStartup+B1
74     call   __setenvp
75     test   eax, eax
76     jge    short loc_401110
77     push   9
78     call   __amsg_exit
79     pop    ecx
80
81 loc_401110: ; CODE XREF: ___tmainCRTStartup+C2
82     push   1
83     call   __cinit
84     pop    ecx
85     test   eax, eax
86     jz     short loc_401123
87     push   eax
88     call   __amsg_exit
89     pop    ecx
90
91 loc_401123: ; CODE XREF: ___tmainCRTStartup+D6
92     mov    eax, envp
93     mov    dword_40AC80, eax

```

```

94     push    eax                ; envp
95     push    argv              ; argv
96     push    argc              ; argc
97     call   __main
98     add    esp, 0Ch
99     mov    [ebp+var_20], eax
100    cmp    [ebp+var_1C], 0
101    jnz    short $LN28
102    push   eax                ; uExitCode
103    call   $LN32
104
105 $LN28: ; CODE XREF: ___tmainCRTStartup+105
106     call   __cexit
107     jmp    short loc_401186
108
109
110 $LN27: ; DATA XREF: .rdata:stru_4092D0
111     mov    eax, [ebp+ms_exc.exc_ptr] ; Exception filter 0 for function 401044
112     mov    ecx, [eax]
113     mov    ecx, [ecx]
114     mov    [ebp+var_24], ecx
115     push   eax
116     push   ecx
117     call  __XcptFilter
118     pop    ecx
119     pop    ecx
120
121 $LN24:
122     retn
123
124
125 $LN14: ; DATA XREF: .rdata:stru_4092D0
126     mov    esp, [ebp+ms_exc.old_esp] ; Exception handler 0 for function 401044
127     mov    eax, [ebp+var_24]
128     mov    [ebp+var_20], eax
129     cmp    [ebp+var_1C], 0
130     jnz    short $LN29
131     push   eax                ; int
132     call   __exit
133
134
135 $LN29: ; CODE XREF: ___tmainCRTStartup+135
136     call  __c_exit
137
138 loc_401186: ; CODE XREF: ___tmainCRTStartup+112
139     mov    [ebp+ms_exc.disabled], 0FFFFFFFh
140     mov    eax, [ebp+var_20]
141     call  __SEH_epilog4
142     retn

```

Here we can see calls to `GetCommandLineA()` (line 62), then to `setargv()` (line 66) and `setenvp()` (line 74), which apparently fill the global variables `argc`, `argv`, `envp`.

Finally, `main()` is called with these arguments (line 97).

There are also calls to functions with self-describing names like `heap_init()` (line 35), `ioinit()` (line 54).

The [heap](#) is indeed initialized in the [CRT](#). If you try to use `malloc()` in a program without CRT, it will exit abnormally with the following error:

```

runtime error R6030
- CRT not initialized

```

Global object initializations in C++ is also occur in the [CRT](#) before the execution of `main()`: [3.21.4 on page 568](#).

The value that `main()` returns is passed to `cexit()`, or in `$LN32`, which in turn calls `doexit()`.

Is it possible to get rid of the [CRT](#)? Yes, if you know what you are doing.

The **MSVC**'s linker has the `/ENTRY` option for setting an entry point.

```
#include <windows.h>

int main()
{
    MessageBox (NULL, "hello, world", "caption", MB_OK);
};
```

Let's compile it in MSVC 2008.

```
cl no_crt.c user32.lib /link /entry:main
```

We are getting a runnable `.exe` with size 2560 bytes, that has a PE header in it, instructions calling `MessageBox`, two strings in the data segment, the `MessageBox` function imported from `user32.dll` and nothing else.

This works, but you cannot write `WinMain` with its 4 arguments instead of `main()`.

To be precise, you can, but the arguments are not prepared at the moment of execution.

By the way, it is possible to make the `.exe` even shorter by aligning the **PE** sections at less than the default 4096 bytes.

```
cl no_crt.c user32.lib /link /entry:main /align:16
```

Linker says:

```
LINK : warning LNK4108: /ALIGN specified without /DRIVER; image may not run
```

We get an `.exe` that's 720 bytes. It can be executed in Windows 7 x86, but not in x64 (an error message will be shown when you try to execute it).

With even more efforts, it is possible to make the executable even shorter, but as you can see, compatibility problems arise quickly.

## 6.5.2 Win32 PE

**PE** is an executable file format used in Windows. The difference between `.exe`, `.dll` and `.sys` is that `.exe` and `.sys` usually do not have exports, only imports.

A **DLL**<sup>14</sup>, just like any other PE-file, has an entry point (**OEP**) (the function `DllMain()` is located there) but this function usually does nothing. `.sys` is usually a device driver. As of drivers, Windows requires the checksum to be present in the PE file and for it to be correct<sup>15</sup>.

Starting at Windows Vista, a driver's files must also be signed with a digital signature. It will fail to load otherwise.

Every PE file begins with tiny DOS program that prints a message like "This program cannot be run in DOS mode."—if you run this program in DOS or Windows 3.1 (**OS**-es which are not aware of the PE format), this message will be printed.

### Terminology

- Module—a separate file, `.exe` or `.dll`.
- Process—a program loaded into memory and currently running. Commonly consists of one `.exe` file and bunch of `.dll` files.
- Process memory—the memory a process works with. Each process has its own. There usually are loaded modules, memory of the stack, **heap**(s), etc.

<sup>14</sup>Dynamic-Link Library

<sup>15</sup>For example, Hiew( [7.1 on page 791](#)) can calculate it



- [VA](#)<sup>16</sup>—an address which is to be used in program while runtime.
- Base address (of module)—the address within the process memory at which the module is to be loaded. OS loader may change it, if the base address is already occupied by another module just loaded before.
- [RVA](#)<sup>17</sup>—the [VA](#)-address minus the base address.  
Many addresses in PE-file tables use [RVA](#)-addresses.
- [IAT](#)<sup>18</sup>—an array of addresses of imported symbols <sup>19</sup>. Sometimes, the `IMAGE_DIRECTORY_ENTRY_IAT` data directory points at the [IAT](#). It is worth noting that [IDA](#) (as of 6.1) may allocate a pseudo-section named `.idata` for [IAT](#), even if the [IAT](#) is a part of another section!
- [INT](#)<sup>20</sup>—an array of names of symbols to be imported<sup>21</sup>.

## Base address

The problem is that several module authors can prepare DLL files for others to use and it is not possible to reach an agreement which addresses is to be assigned to whose modules.

So that is why if two necessary DLLs for a process have the same base address, one of them will be loaded at this base address, and the other—at some other free space in process memory, and each virtual addresses in the second DLL will be corrected.

With [MSVC](#) the linker often generates the `.exe` files with a base address of `0x400000` <sup>22</sup>, and with the code section starting at `0x401000`. This means that the [RVA](#) of the start of the code section is `0x1000`.

DLLs are often generated by [MSVC](#)'s linker with a base address of `0x10000000` <sup>23</sup>.

There is also another reason to load modules at various base addresses, in this case random ones. It is [ASLR](#).

A shellcode trying to get executed on a compromised system must call system functions, hence, know their addresses.

In older OS (in [Windows NT](#) line: before Windows Vista), system DLL (like `kernel32.dll`, `user32.dll`) were always loaded at known addresses, and if we also recall that their versions rarely changed, the addresses of functions were fixed and shellcode could call them directly.

In order to avoid this, the [ASLR](#) method loads your program and all modules it needs at random base addresses, different every time.

[ASLR](#) support is denoted in a PE file by setting the flag

`IMAGE_DLL_CHARACTERISTICS_DYNAMIC_BASE` [see Mark Russinovich, *Microsoft Windows Internals*].

## Subsystem

There is also a *subsystem* field, usually it is:

- [native](#)<sup>24</sup> (`.sys-driver`),
- `console` (console application) or
- [GUI](#) (non-console).

## OS version

A PE file also specifies the minimal Windows version it needs in order to be loadable.

The table of version numbers stored in the PE file and corresponding Windows codenames is here.

For example, [MSVC](#) 2005 compiles `.exe` files for running on Windows NT4 (version 4.00), but [MSVC](#) 2008 does not (the generated files have a version of 5.00, at least Windows 2000 is needed to run them).

<sup>16</sup>Virtual Address

<sup>17</sup>Relative Virtual Address

<sup>18</sup>Import Address Table

<sup>19</sup>Matt Pietrek, *An In-Depth Look into the Win32 Portable Executable File Format*, (2002)]

<sup>20</sup>Import Name Table

<sup>21</sup>Matt Pietrek, *An In-Depth Look into the Win32 Portable Executable File Format*, (2002)]

<sup>22</sup>The origin of this address choice is described here: [MSDN](#)

<sup>23</sup>This can be changed by the `/BASE` linker option

<sup>24</sup>Meaning, the module use Native API instead of Win32

[MSVC](#) 2012 generates .exe files of version 6.00 by default, targeting at least Windows Vista. However, by changing the compiler's options<sup>25</sup>, it is possible to force it to compile for Windows XP.

## Sections

Division in sections, as it seems, is present in all executable file formats.

It is devised in order to separate code from data, and data—from constant data.

- Either the *IMAGE\_SCN\_CNT\_CODE* or *IMAGE\_SCN\_MEM\_EXECUTE* flags will be set on the code section—this is executable code.
- On data section—*IMAGE\_SCN\_CNT\_INITIALIZED\_DATA*, *IMAGE\_SCN\_MEM\_READ* and *IMAGE\_SCN\_MEM\_WRITE* flags.
- On an empty section with uninitialized data—*IMAGE\_SCN\_CNT\_UNINITIALIZED\_DATA*, *IMAGE\_SCN\_MEM\_READ* and *IMAGE\_SCN\_MEM\_WRITE*.
- On a constant data section (one that's protected from writing), the flags *IMAGE\_SCN\_CNT\_INITIALIZED\_DATA* and *IMAGE\_SCN\_MEM\_READ* can be set, but not *IMAGE\_SCN\_MEM\_WRITE*. A process going to crash if it tries to write to this section.

Each section in PE-file may have a name, however, it is not very important. Often (but not always) the code section is named `.text`, the data section—`.data`, the constant data section — `.rdata` (*readable data*) (perhaps, `.rdata` means *read-only-data*). Other popular section names are:

- `.idata`—imports section. [IDA](#) may create a pseudo-section named like this: [6.5.2 on the preceding page](#).
- `.edata`—exports section (rare)
- `.pdata`—section holding all information about exceptions in Windows NT for MIPS, IA64 and x64: [6.5.3 on page 785](#)
- `.reloc`—relocs section
- `.bss`—uninitialized data ([BSS](#))
- `.tls`—thread local storage ([TLS](#))
- `.rsrc`—resources
- `.CRT`—may present in binary files compiled by ancient MSVC versions

PE file packers/encryptors often garble section names or replace the names with their own.

[MSVC](#) allows you to declare data in arbitrarily named section <sup>26</sup>.

Some compilers and linkers can add a section with debugging symbols and other debugging information (MinGW for instance). However it is not so in latest versions of [MSVC](#) (separate [PDB](#) files are used there for this purpose).

That is how a PE section is described in the file:

```
typedef struct _IMAGE_SECTION_HEADER {
    BYTE Name[IMAGE_SIZEOF_SHORT_NAME];
    union {
        DWORD PhysicalAddress;
        DWORD VirtualSize;
    } Misc;
    DWORD VirtualAddress;
    DWORD SizeOfRawData;
    DWORD PointerToRawData;
    DWORD PointerToRelocations;
    DWORD PointerToLinenumbers;
    WORD NumberOfRelocations;
    WORD NumberOfLinenumbers;
    DWORD Characteristics;
} IMAGE_SECTION_HEADER, *PIMAGE_SECTION_HEADER;
```

<sup>25</sup>[MSDN](#)

<sup>26</sup>[MSDN](#)

A word about terminology: *PointerToRawData* is called “Offset” in Hiew and *VirtualAddress* is called “RVA” there.

## Data section

Data section in file can be smaller than in memory. For example, some variables can be initialized, some are not. Compiler and linker will collect them all into one section, but the first part of it is initialized and allocated in file, while another is absent in file (of course, to make it smaller). *VirtualSize* will be equal to the size of section in memory, and *SizeOfRawData* — to size of section in file.

IDA can show the border between initialized and not initialized parts like that:

```
...
.data:10017FFA          db    0
.data:10017FFB          db    0
.data:10017FFC          db    0
.data:10017FFD          db    0
.data:10017FFE          db    0
.data:10017FFF          db    0
.data:10018000          db    ? ;
.data:10018001          db    ? ;
.data:10018002          db    ? ;
.data:10018003          db    ? ;
.data:10018004          db    ? ;
.data:10018005          db    ? ;
...
```

## .rdata — read-only data section

Strings are usually located here (because they have `const char*` type), other variables marked as *const*, imported function names.

See also: [3.3 on page 472](#).

## Relocations (relocs)

AKA FIXUP-s (at least in Hiew).

They are also present in almost all executable file formats <sup>28</sup>. Exceptions are shared dynamic libraries compiled with PIC, or any other PIC-code.

What are they for?

Obviously, modules can be loaded on various base addresses, but how to deal with global variables, for example? They must be accessed by address. One solution is position-independent code ( [6.4.1 on page 750](#)). But it is not always convenient.

That is why a relocations table is present. There the addresses of points that must be corrected are enumerated, in case of loading at a different base address.

For example, there is a global variable at address 0x410000 and this is how it is accessed:

```
A1 00 00 41 00      mov     eax, [000410000]
```

The base address of the module is 0x400000, the *RVA* of the global variable is 0x10000.

If the module is loaded at base address 0x500000, the real address of the global variable must be 0x510000.

As we can see, the address of variable is encoded in the instruction MOV, after the byte 0xA1.

That is why the address of the 4 bytes after 0xA1, is written in the relocs table.

<sup>27</sup>[MSDN](#)

<sup>28</sup>Even in .exe files for MS-DOS

If the module is loaded at a different base address, the OS loader enumerates all addresses in the table, finds each 32-bit word the address points to, subtracts the original base address from it (we get the RVA here), and adds the new base address to it.

If a module is loaded at its original base address, nothing happens.

All global variables can be treated like that.

Relocs may have various types, however, in Windows for x86 processors, the type is usually *IMAGE\_REL\_BASED\_HIGHLOW*.

By the way, relocs are darkened in Hiew, for example: fig.1.22. (You have to circumvent these bytes during patching.)

OllyDbg underlines the places in memory to which relocs are to be applied, for example: fig.1.53.

## Exports and imports

As we all know, any executable program must use the OS's services and other DLL-libraries somehow.

It can be said that functions from one module (usually DLL) must be connected somehow to the points of their calls in other modules (.exe-file or another DLL).

For this, each DLL has an "exports" table, which consists of functions plus their addresses in a module.

And every .exe file or DLL has "imports", a table of functions it needs for execution including list of DLL filenames.

After loading the main .exe-file, the OS loader processes imports table: it loads the additional DLL-files, finds function names among the DLL exports and writes their addresses down in the IAT of the main .exe-module.

As we can see, during loading the loader must compare a lot of function names, but string comparison is not a very fast procedure, so there is a support for "ordinals" or "hints", which are function numbers stored in the table, instead of their names.

That is how they can be located faster when loading a DLL. Ordinals are always present in the "export" table.

For example, a program using the MFC<sup>29</sup> library usually loads mfc\*.dll by ordinals, and in such programs there are no MFC function names in INT.

When loading such programs in IDA, it will ask for a path to the mfc\*.dll files in order to determine the function names.

If you don't tell IDA the path to these DLLs, there will be *mfc80\_123* instead of function names.

## Imports section

Often a separate section is allocated for the imports table and everything related to it (with name like .idata), however, this is not a strict rule.

Imports are also a confusing subject because of the terminological mess. Let's try to collect all information in one place.

---

<sup>29</sup>Microsoft Foundation Classes

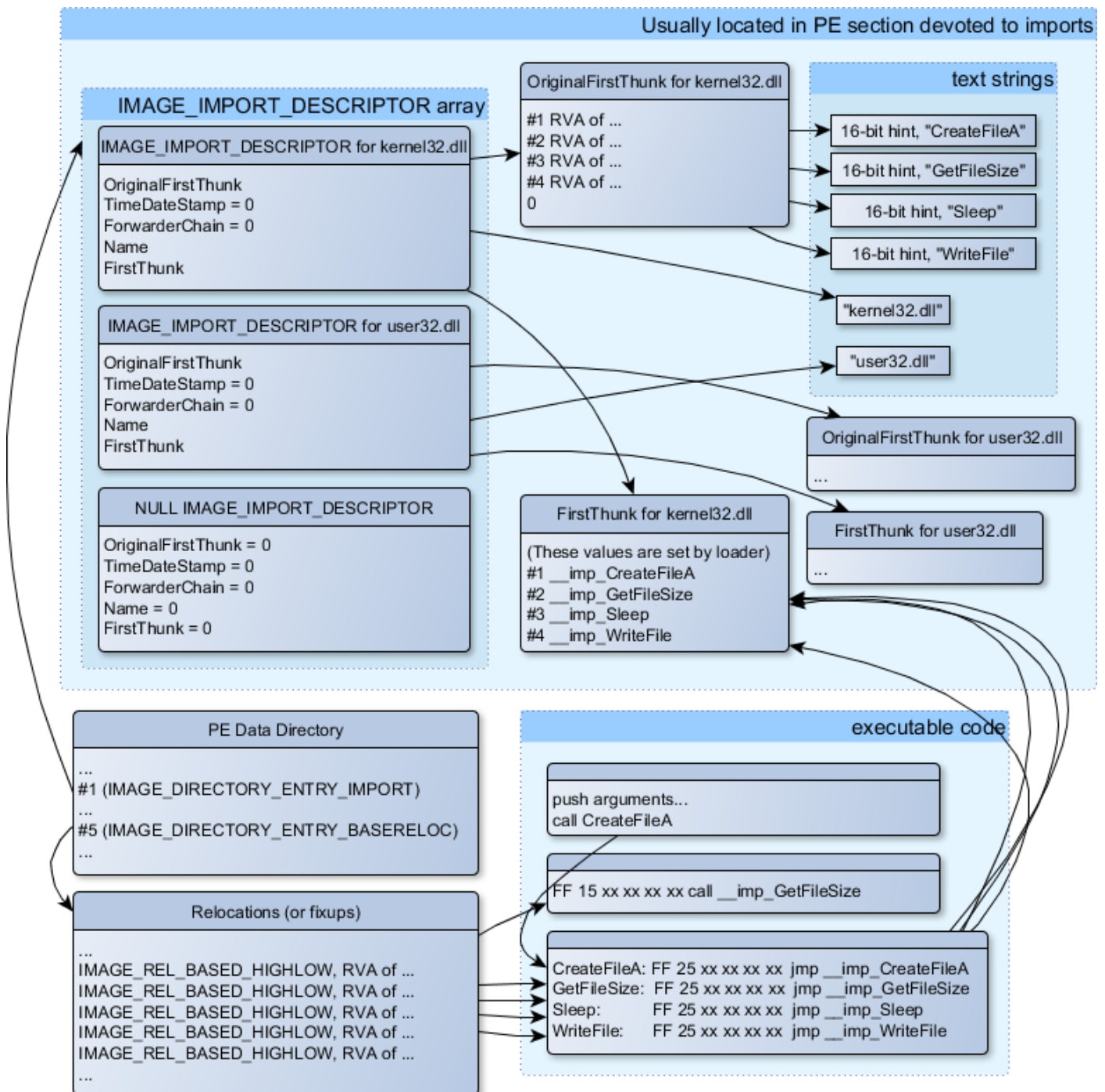

Figure 6.1: A scheme that unites all PE-file structures related to imports

The main structure is the array *IMAGE\_IMPORT\_DESCRIPTOR*. Each element for each DLL being imported. Each element holds the *RVA* address of the text string (DLL name) (*Name*).

*OriginalFirstThunk* is the *RVA* address of the *INT* table. This is an array of *RVA* addresses, each of which points to a text string with a function name. Each string is prefixed by a 16-bit integer ("hint")—"ordinal" of function.

While loading, if it is possible to find a function by ordinal, then the strings comparison will not occur. The array is terminated by zero.

There is also a pointer to the *IAT* table named *FirstThunk*, it is just the *RVA* address of the place where the loader writes the addresses of the resolved functions.

The points where the loader writes addresses are marked by *IDA* like this: *\_\_imp\_CreateFileA*, etc.

There are at least two ways to use the addresses written by the loader.

- The code will have instructions like `call __imp_CreateFileA`, and since the field with the address of

the imported function is a global variable in some sense, the address of the *call* instruction (plus 1 or 2) is to be added to the relocs table, for the case when the module is loaded at a different base address.

But, obviously, this may enlarge relocs table significantly.

Because there are might be a lot of calls to imported functions in the module.

Furthermore, large relocs table slows down the process of loading modules.

- For each imported function, there is only one jump allocated, using the JMP instruction plus a reloc to it. Such points are also called “thunks”.

All calls to the imported functions are just CALL instructions to the corresponding “thunk”. In this case, additional relocs are not necessary because these CALL-s have relative addresses and do not need to be corrected.

These two methods can be combined.

Possible, the linker creates individual “thunk”s if there are too many calls to the function, but not done by default.

By the way, the array of function addresses to which FirstThunk is pointing is not necessary to be located in the IAT section. For example, the author of these lines once wrote the PE\_add\_import<sup>30</sup> utility for adding imports to an existing .exe-file.

Some time earlier, in the previous versions of the utility, at the place of the function you want to substitute with a call to another DLL, my utility wrote the following code:

```
MOV EAX, [yourdll.dll!function]
JMP EAX
```

FirstThunk points to the first instruction. In other words, when loading yourdll.dll, the loader writes the address of the *function* function right in the code.

It also worth noting that a code section is usually write-protected, so my utility adds the *IMAGE\_SCN\_MEM\_WRITE* flag for code section. Otherwise, the program to crash while loading with error code 5 (access denied).

One might ask: what if I supply a program with a set of DLL files which is not supposed to change (including addresses of all DLL functions), is it possible to speed up the loading process?

Yes, it is possible to write the addresses of the functions to be imported into the FirstThunk arrays in advance. The *Timestamp* field is present in the *IMAGE\_IMPORT\_DESCRIPTOR* structure.

If a value is present there, then the loader compares this value with the date-time of the DLL file.

If the values are equal, then the loader does not do anything, and the loading of the process can be faster. This is called “old-style binding”<sup>31</sup>.

The BIND.EXE utility in Windows SDK is for this. For speeding up the loading of your program, Matt Pietrek in Matt Pietrek, *An In-Depth Look into the Win32 Portable Executable File Format*, (2002)]<sup>32</sup>, suggests to do the binding shortly after your program installation on the computer of the end user.

PE-files packers/encryptors may also compress/encrypt imports table.

In this case, the Windows loader, of course, will not load all necessary DLLs.

Therefore, the packer/encryptor does this on its own, with the help of *LoadLibrary()* and the *GetProcAddress()* functions.

That is why these two functions are often present in IAT in packed files.

In the standard DLLs from the Windows installation, IAT often is located right at the beginning of the PE file. Supposedly, it is made so for optimization.

<sup>30</sup>[yurichev.com](http://yurichev.com)

<sup>31</sup>MSDN. There is also the “new-style binding”.

<sup>32</sup>Also available as <http://go.yurichev.com/17318>

While loading, the .exe file is not loaded into memory as a whole (recall huge install programs which are started suspiciously fast), it is “mapped”, and loaded into memory in parts as they are accessed.

Probably, Microsoft developers decided it will be faster.

## Resources

Resources in a PE file are just a set of icons, pictures, text strings, dialog descriptions.

Perhaps they were separated from the main code, so all these things could be multilingual, and it would be simpler to pick text or picture for the language that is currently set in the OS.

As a side effect, they can be edited easily and saved back to the executable file, even if one does not have special knowledge, by using the ResHack editor, for example ( 6.5.2).

## .NET

.NET programs are not compiled into machine code but into a special bytecode. Strictly speaking, there is bytecode instead of the usual x86 code in the .exe file, however, the entry point (OEP) points to this tiny fragment of x86 code:

```
jmp     mscoree.dll!_CorExeMain
```

The .NET loader is located in mscoree.dll, which processes the PE file.

It was so in all pre-Windows XP OSes. Starting from XP, the OS loader is able to detect the .NET file and run it without executing that JMP instruction<sup>33</sup>.

## TLS

This section holds initialized data for the TLS( 6.2 on page 744) (if needed). When a new thread start, its TLS data is initialized using the data from this section.

Aside from that, the PE file specification also provides initialization of the TLS section, the so-called TLS callbacks.

If they are present, they are to be called before the control is passed to the main entry point (OEP).

This is used widely in the PE file packers/encryptors.

## Tools

- objdump (present in cygwin) for dumping all PE-file structures.
- Hiew( 7.1 on page 791) as editor.
- pefile—Python-library for PE-file processing<sup>34</sup>.
- ResHack AKA Resource Hacker—resources editor<sup>35</sup>.
- PE\_add\_import<sup>36</sup>— simple tool for adding symbol(s) to PE executable import table.
- PE\_patcher<sup>37</sup>—simple tool for patching PE executables.
- PE\_search\_str\_refs<sup>38</sup>—simple tool for searching for a function in PE executables which use some text string.

## Further reading

- Daniel Pistelli—The .NET File Format<sup>39</sup>

<sup>33</sup>MSDN

<sup>34</sup><http://go.yurichev.com/17052>

<sup>35</sup><http://go.yurichev.com/17052>

<sup>36</sup><http://go.yurichev.com/17049>

<sup>37</sup>[yurichev.com](http://yurichev.com)

<sup>38</sup>[yurichev.com](http://yurichev.com)

<sup>39</sup><http://go.yurichev.com/17056>

### 6.5.3 Windows SEH

#### Let's forget about MSVC

In Windows, the **SEH** is intended for exceptions handling, nevertheless, it is language-agnostic, not related to C++ or **OOP** in any way.

Here we are going to take a look at **SEH** in its isolated (from C++ and MSVC extensions) form.

Each running process has a chain of **SEH** handlers, each **TIB** has the address of the most recently defined handler.

When an exception occurs (division by zero, incorrect address access, user exception triggered by calling the `RaiseException()` function), the **OS** finds the last handler in the **TIB** and calls it, passing exception kind and all information about the **CPU** state (register values, etc.) at the moment of the exception.

The exception handler considering the exception, does it see something familiar? If so, it handles the exception.

If not, it signals to the **OS** that it cannot handle it and the **OS** calls the next handler in the chain, until a handler which is able to handle the exception is be found.

At the very end of the chain there a standard handler that shows the well-known dialog box, informing the user about a process crash, some technical information about the **CPU** state at the time of the crash, and offering to collect all information and send it to developers in Microsoft.

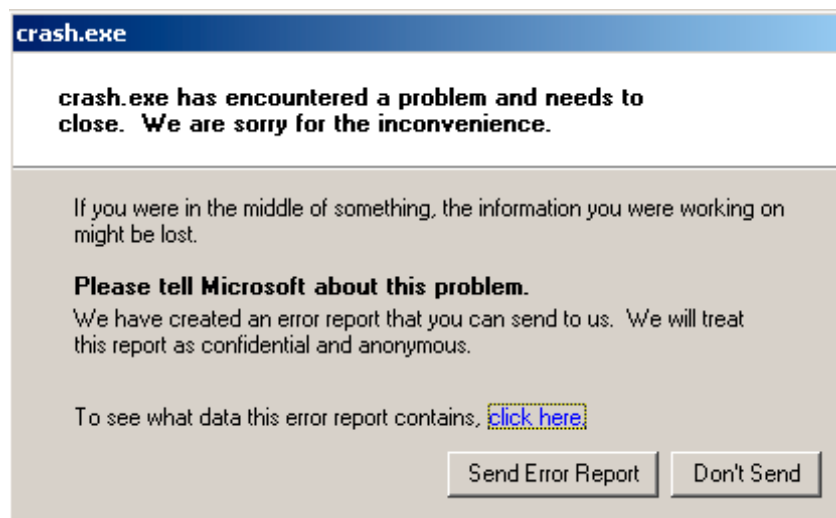

Figure 6.2: Windows XP



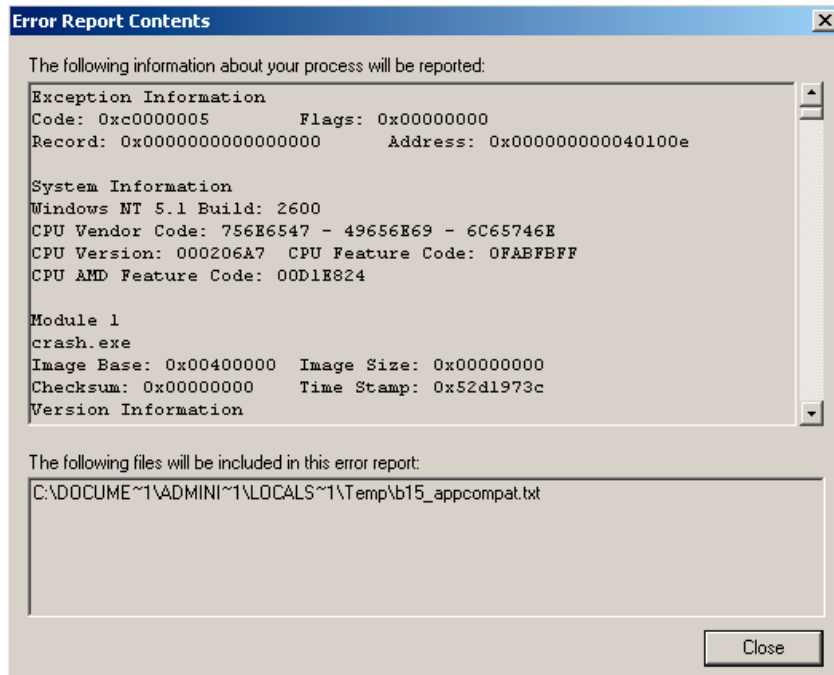

Figure 6.3: Windows XP

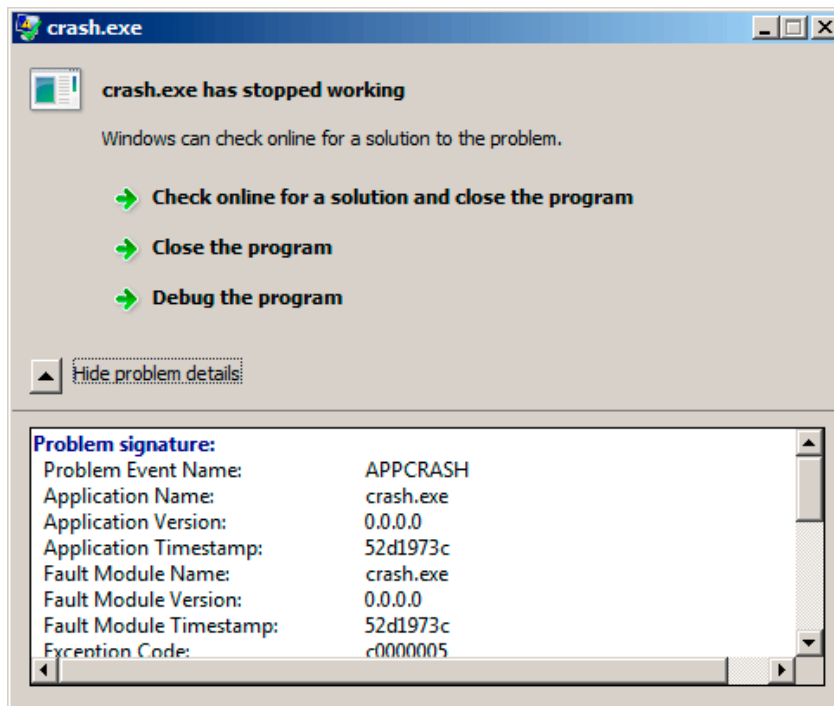

Figure 6.4: Windows 7

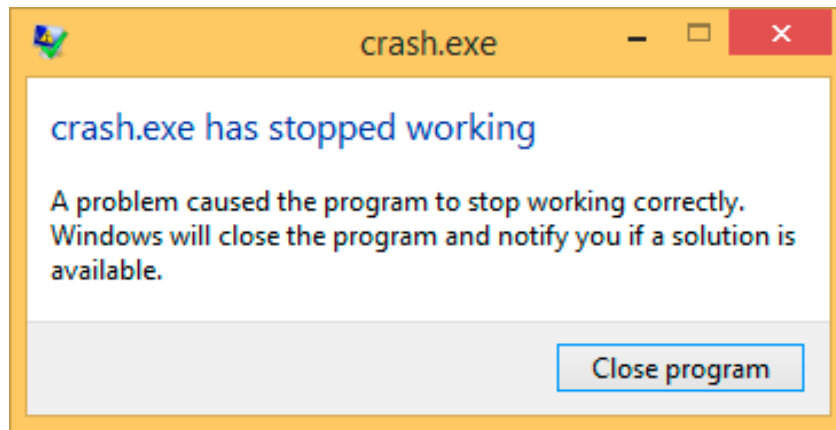

Figure 6.5: Windows 8.1

Earlier, this handler was called Dr. Watson.

By the way, some developers make their own handler that sends information about the program crash to themselves. It is registered with the help of `SetUnhandledExceptionFilter()` and to be called if the OS does not have any other way to handle the exception. An example is Oracle RDBMS—it saves huge dumps reporting all possible information about the CPU and memory state.

Let's write our own primitive exception handler. This example is based on the example from [Matt Pietrek, *A Crash Course on the Depths of Win32™ Structured Exception Handling*, (1997)]<sup>40</sup>. It must be compiled with the SAFESEH option: `cl seh1.cpp /link /safeseh:no`. More about SAFESEH here: [MSDN](#).

```
#include <windows.h>
#include <stdio.h>

DWORD new_value=1234;

EXCEPTION_DISPOSITION __cdecl except_handler(
    struct _EXCEPTION_RECORD *ExceptionRecord,
    void * EstablisherFrame,
    struct _CONTEXT *ContextRecord,
    void * DispatcherContext )
{
    unsigned i;

    printf ("%s\n", __FUNCTION__);
    printf ("ExceptionRecord->ExceptionCode=0x%p\n", ExceptionRecord->ExceptionCode);
    printf ("ExceptionRecord->ExceptionFlags=0x%p\n", ExceptionRecord->ExceptionFlags);
    printf ("ExceptionRecord->ExceptionAddress=0x%p\n", ExceptionRecord->ExceptionAddress);

    if (ExceptionRecord->ExceptionCode==0xE1223344)
    {
        printf ("That's for us\n");
        // yes, we "handled" the exception
        return ExceptionContinueExecution;
    }
    else if (ExceptionRecord->ExceptionCode==EXCEPTION_ACCESS_VIOLATION)
    {
        printf ("ContextRecord->Eax=0x%08X\n", ContextRecord->Eax);
        // will it be possible to 'fix' it?
        printf ("Trying to fix wrong pointer address\n");
        ContextRecord->Eax=(DWORD)&new_value;
        // yes, we "handled" the exception
        return ExceptionContinueExecution;
    }
    else
    {
        printf ("We do not handle this\n");
        // someone else's problem
        return ExceptionContinueSearch;
    }
};
```

<sup>40</sup>Also available as <http://go.yurichev.com/17293>

```

}
int main()
{
    DWORD handler = (DWORD)except_handler; // take a pointer to our handler

    // install exception handler
    __asm
    {
        push    handler           // make EXCEPTION_REGISTRATION record:
        push    FS:[0]           // address of handler function
        mov     FS:[0],ESP       // address of previous handler
        // add new EXECEPTION_REGISTRATION
    }

    RaiseException (0xE1223344, 0, 0, NULL);

    // now do something very bad
    int* ptr=NULL;
    int val=0;
    val=*ptr;
    printf ("val=%d\n", val);

    // deinstall exception handler
    __asm
    {
        mov     eax,[ESP]        // remove our EXECEPTION_REGISTRATION record
        mov     FS:[0], EAX     // get pointer to previous record
        add     esp, 8          // install previous record
        // clean our EXECEPTION_REGISTRATION off stack
    }

    return 0;
}

```

The FS: segment register is pointing to the [TIB](#) in win32.

The very first element in the [TIB](#) is a pointer to the last handler in the chain. We save it in the stack and store the address of our handler there. The structure is named `_EXCEPTION_REGISTRATION`, it is a simple singly-linked list and its elements are stored right in the stack.

Listing 6.22: MSVC/VC/crt/src/exsup.inc

```

_EXCEPTION_REGISTRATION struc
    prev    dd    ?
    handler dd    ?
_EXCEPTION_REGISTRATION ends

```

So each “handler” field points to a handler and an each “prev” field points to the previous record in the chain of exception handlers. The last record has `0xFFFFFFFF` (-1) in the “prev” field.

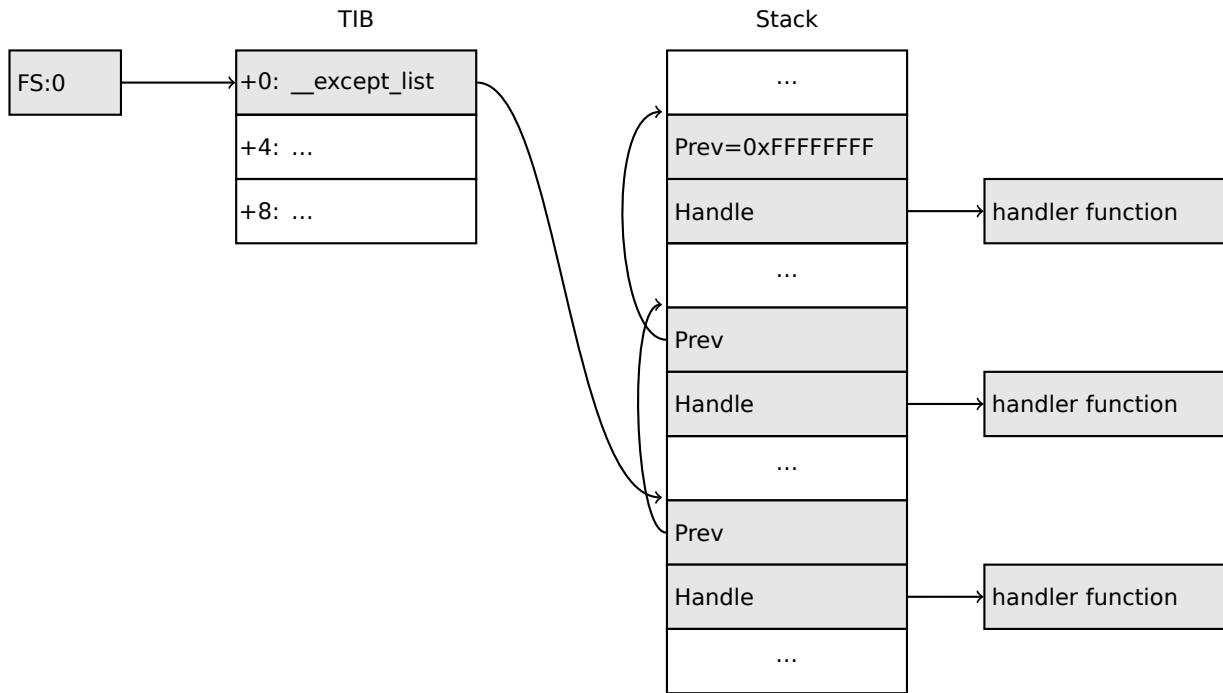

After our handler is installed, we call `RaiseException()`<sup>41</sup>. This is an user exception. The handler checks the code. If the code is `0xE1223344`, it returning `ExceptionContinueExecution`, which means that handler corrected the CPU state (it is usually a correction of the EIP/ESP registers) and the OS can resume the execution of the thread. If you alter slightly the code so the handler returns `ExceptionContinueSearch`, then the OS will call the other handlers, and it's unlikely that one who can handle it will be found, since no one will have any information about it (rather about its code). You will see the standard Windows dialog about a process crash.

What is the difference between a system exceptions and a user one? Here are the system ones:

as defined in WinBase.h	as defined in ntstatus.h	value
EXCEPTION_ACCESS_VIOLATION	STATUS_ACCESS_VIOLATION	0xC0000005
EXCEPTION_DATATYPE_MISALIGNMENT	STATUS_DATATYPE_MISALIGNMENT	0x80000002
EXCEPTION_BREAKPOINT	STATUS_BREAKPOINT	0x80000003
EXCEPTION_SINGLE_STEP	STATUS_SINGLE_STEP	0x80000004
EXCEPTION_ARRAY_BOUNDS_EXCEEDED	STATUS_ARRAY_BOUNDS_EXCEEDED	0xC000008C
EXCEPTION_FLT_DENORMAL_OPERAND	STATUS_FLOAT_DENORMAL_OPERAND	0xC000008D
EXCEPTION_FLT_DIVIDE_BY_ZERO	STATUS_FLOAT_DIVIDE_BY_ZERO	0xC000008E
EXCEPTION_FLT_INEXACT_RESULT	STATUS_FLOAT_INEXACT_RESULT	0xC000008F
EXCEPTION_FLT_INVALID_OPERATION	STATUS_FLOAT_INVALID_OPERATION	0xC0000090
EXCEPTION_FLT_OVERFLOW	STATUS_FLOAT_OVERFLOW	0xC0000091
EXCEPTION_FLT_STACK_CHECK	STATUS_FLOAT_STACK_CHECK	0xC0000092
EXCEPTION_FLT_UNDERFLOW	STATUS_FLOAT_UNDERFLOW	0xC0000093
EXCEPTION_INT_DIVIDE_BY_ZERO	STATUS_INTEGER_DIVIDE_BY_ZERO	0xC0000094
EXCEPTION_INT_OVERFLOW	STATUS_INTEGER_OVERFLOW	0xC0000095
EXCEPTION_PRIV_INSTRUCTION	STATUS_PRIVILEGED_INSTRUCTION	0xC0000096
EXCEPTION_IN_PAGE_ERROR	STATUS_IN_PAGE_ERROR	0xC0000006
EXCEPTION_ILLEGAL_INSTRUCTION	STATUS_ILLEGAL_INSTRUCTION	0xC000001D
EXCEPTION_NONCONTINUABLE_EXCEPTION	STATUS_NONCONTINUABLE_EXCEPTION	0xC0000025
EXCEPTION_STACK_OVERFLOW	STATUS_STACK_OVERFLOW	0xC00000FD
EXCEPTION_INVALID_DISPOSITION	STATUS_INVALID_DISPOSITION	0xC0000026
EXCEPTION_GUARD_PAGE	STATUS_GUARD_PAGE_VIOLATION	0x80000001
EXCEPTION_INVALID_HANDLE	STATUS_INVALID_HANDLE	0xC0000008
EXCEPTION_POSSIBLE_DEADLOCK	STATUS_POSSIBLE_DEADLOCK	0xC0000194
CONTROL_C_EXIT	STATUS_CONTROL_C_EXIT	0xC000013A

That is how the code is defined:

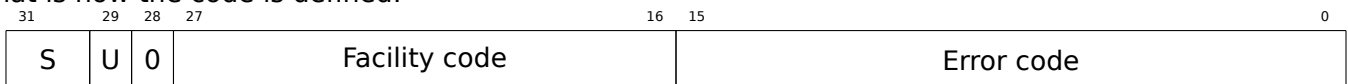

S is a basic status code: 11—error; 10—warning; 01—informational; 00—success. U—whether the code is user code.

<sup>41</sup>MSDN

That is why we chose 0xE1223344—E<sub>16</sub> (1110<sub>2</sub>) 0xE (1110<sub>b</sub>) means that it is 1) user exception; 2) error. But to be honest, this example works fine without these high bits.

Then we try to read a value from memory at address 0.

Of course, there is nothing at this address in win32, so an exception is raised.

The very first handler is to be called—yours, and it will know about it first, by checking the code if it's equal to the EXCEPTION\_ACCESS\_VIOLATION constant.

The code that's reading from memory at address 0 is looks like this:

Listing 6.23: MSVC 2010

```
...
xor    eax, eax
mov    eax, DWORD PTR [eax] ; exception will occur here
push  eax
push  OFFSET msg
call  _printf
add   esp, 8
...
```

Will it be possible to fix this error “on the fly” and to continue with program execution?

Yes, our exception handler can fix the EAX value and let the OS execute this instruction once again. So that is what we do. printf() prints 1234, because after the execution of our handler EAX is not 0, but contains the address of the global variable new\_value. The execution will resume.

That is what is going on: the memory manager in the CPU signals about an error, the CPU suspends the thread, finds the exception handler in the Windows kernel, which, in turn, starts to call all handlers in the SEH chain, one by one.

We use MSVC 2010 here, but of course, there is no any guarantee that EAX will be used for this pointer.

This address replacement trick is showy, and we considering it here as an illustration of SEH's internals. Nevertheless, it's hard to recall any case where it is used for “on-the-fly” error fixing.

Why SEH-related records are stored right in the stack instead of some other place?

Supposedly because the OS is not needing to care about freeing this information, these records are simply disposed when the function finishes its execution. This is somewhat like alloca(): ( 1.9.2 on page 35).

## Now let's get back to MSVC

Supposedly, Microsoft programmers needed exceptions in C, but not in C++ (for use in Windows NT kernel, which is written in C), so they added a non-standard C extension to MSVC<sup>42</sup>. It is not related to C++ PL exceptions.

```
_try
{
    ...
}
_except(filter code)
{
    handler code
}
```

“Finally” block may be instead of handler code:

```
_try
{
    ...
}
_finally
{
    ...
}
```

<sup>42</sup>MSDN

The filter code is an expression, telling whether this handler code corresponds to the exception raised. If your code is too big and cannot fit into one expression, a separate filter function can be defined.

There are a lot of such constructs in the Windows kernel. Here are a couple of examples from there (WRK):

Listing 6.24: WRK-v1.2/base/ntos/ob/obwait.c

```
try {
    KeReleaseMutant( (PKMUTANT)SignalObject,
                    MUTANT_INCREMENT,
                    FALSE,
                    TRUE );
} except((GetExceptionCode () == STATUS_ABANDONED ||
        GetExceptionCode () == STATUS_MUTANT_NOT_OWNED)?
        EXCEPTION_EXECUTE_HANDLER :
        EXCEPTION_CONTINUE_SEARCH) {
    Status = GetExceptionCode();

    goto WaitExit;
}
```

Listing 6.25: WRK-v1.2/base/ntos/cache/cachesub.c

```
try {
    RtlCopyBytes( (PVOID)((PCHAR)CacheBuffer + PageOffset),
                UserBuffer,
                MorePages ?
                (PAGE_SIZE - PageOffset) :
                (ReceivedLength - PageOffset) );
} except( CcCopyReadExceptionFilter( GetExceptionInformation(),
                                    &Status ) ) {
```

Here is also a filter code example:

Listing 6.26: WRK-v1.2/base/ntos/cache/copysup.c

```
LONG
CcCopyReadExceptionFilter(
    IN PEXCEPTION_POINTERS ExceptionPointer,
    IN PNTSTATUS ExceptionCode
)

/*++

Routine Description:

    This routine serves as an exception filter and has the special job of
    extracting the "real" I/O error when Mm raises STATUS_IN_PAGE_ERROR
    beneath us.

Arguments:

    ExceptionPointer - A pointer to the exception record that contains
                      the real Io Status.

    ExceptionCode - A pointer to an NTSTATUS that is to receive the real
                    status.

Return Value:

    EXCEPTION_EXECUTE_HANDLER

--*/
{
```

```

*ExceptionCode = ExceptionPointer->ExceptionRecord->ExceptionCode;

if ( (*ExceptionCode == STATUS_IN_PAGE_ERROR) &&
      (ExceptionPointer->ExceptionRecord->NumberParameters >= 3) ) {

    *ExceptionCode = (NTSTATUS) ExceptionPointer->ExceptionRecord->ExceptionInformation[2];
}

ASSERT( !NT_SUCCESS(*ExceptionCode) );

return EXCEPTION_EXECUTE_HANDLER;
}

```

Internally, SEH is an extension of the OS-supported exceptions. But the handler function is `_except_handler3` (for SEH3) or `_except_handler4` (for SEH4).

The code of this handler is MSVC-related, it is located in its libraries, or in `msvcr*.dll`. It is very important to know that SEH is a MSVC thing.

Other win32-compilers may offer something completely different.

### SEH3

SEH3 has `_except_handler3` as a handler function, and extends the `_EXCEPTION_REGISTRATION` table, adding a pointer to the *scope table* and *previous try level* variable. SEH4 extends the *scope table* by 4 values for buffer overflow protection.

The *scope table* is a table that consists of pointers to the filter and handler code blocks, for each nested level of *try/except*.

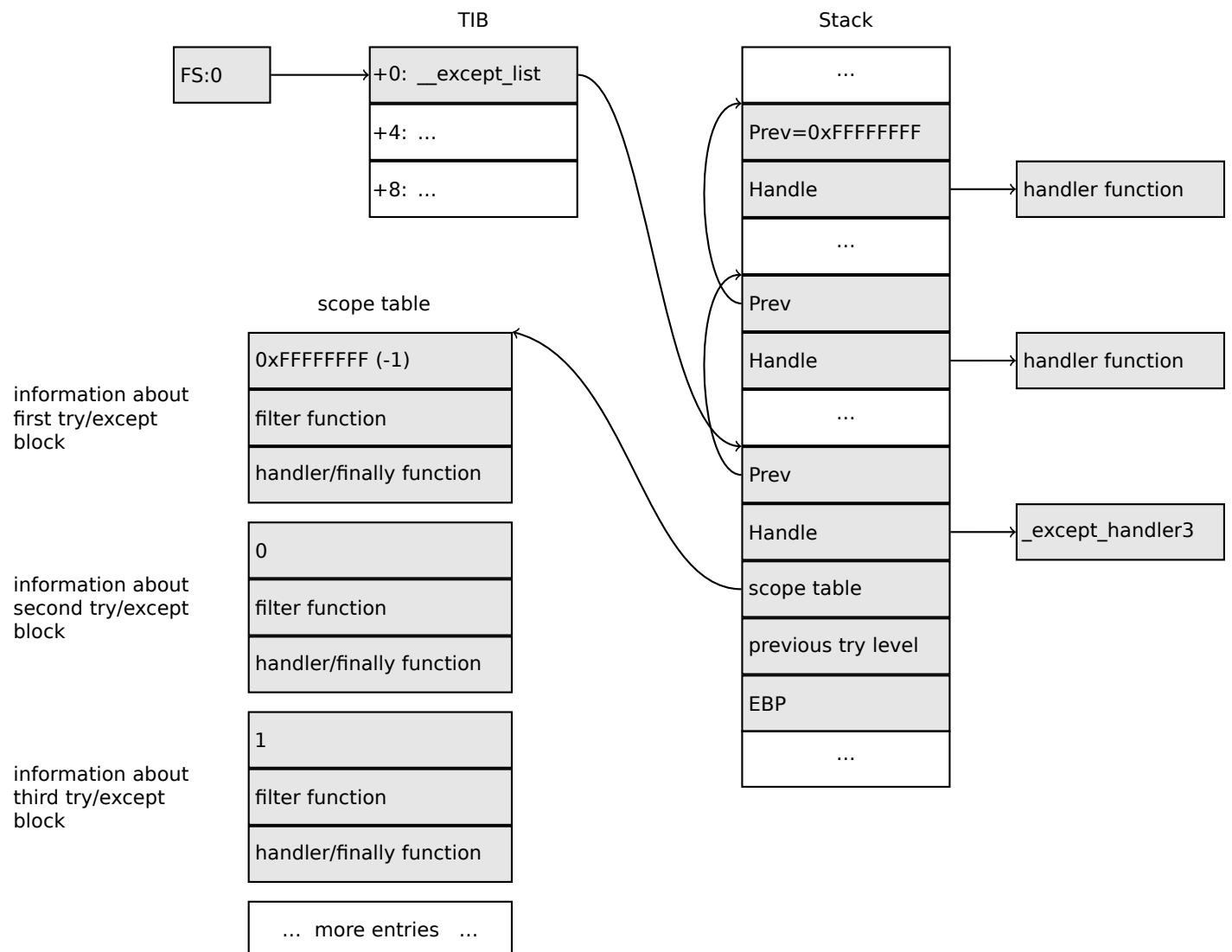

Again, it is very important to understand that the OS takes care only of the *prev/handle* fields, and nothing more.

It is the job of the `_except_handler3` function to read the other fields and *scope table*, and decide which handler to execute and when.

The source code of the `_except_handler3` function is closed.

However, Sanos OS, which has a win32 compatibility layer, has the same functions reimplemented, which are somewhat equivalent to those in Windows<sup>43</sup>. Another reimplementation is present in Wine<sup>44</sup> and ReactOS<sup>45</sup>.

If the *filter* pointer is NULL, the *handler* pointer is the pointer to the *finally* code block.

During execution, the *previous try level* value in the stack changes, so `_except_handler3` can get information about the current level of nestedness, in order to know which *scope table* entry to use.

### SEH3: one try/except block example

```
#include <stdio.h>
#include <windows.h>
#include <excpt.h>

int main()
{
    int* p = NULL;
    __try
    {
        printf("hello #1!\n");
        *p = 13; // causes an access violation exception;
        printf("hello #2!\n");
    }
    __except(GetExceptionCode()==EXCEPTION_ACCESS_VIOLATION ?
             EXCEPTION_EXECUTE_HANDLER : EXCEPTION_CONTINUE_SEARCH)
    {
        printf("access violation, can't recover\n");
    }
}
```

Listing 6.27: MSVC 2003

```
$SG74605 DB 'hello #1!', 0aH, 00H
$SG74606 DB 'hello #2!', 0aH, 00H
$SG74608 DB 'access violation, can't recover', 0aH, 00H
_DATA ENDS

; scope table:
CONST SEGMENT
$T74622 DD 0fffffffH ; previous try level
        DD FLAT:$L74617 ; filter
        DD FLAT:$L74618 ; handler

CONST ENDS
_TEXT SEGMENT
$T74621 = -32 ; size = 4
_p$ = -28 ; size = 4
__$SEHRec$ = -24 ; size = 24
_main PROC NEAR
    push ebp
    mov ebp, esp
    push -1 ; previous try level
    push OFFSET FLAT:$T74622 ; scope table
    push OFFSET FLAT:__except_handler3 ; handler
    mov eax, DWORD PTR fs:__except_list
    push eax ; prev
```

<sup>43</sup><http://go.yurichev.com/17058>

<sup>44</sup>[GitHub](#)

<sup>45</sup><http://go.yurichev.com/17060>



```

    mov     DWORD PTR fs:__except_list, esp
    add     esp, -16
; 3 registers to be saved:
    push   ebx
    push   esi
    push   edi
    mov     DWORD PTR __$SEHRec$[ebp], esp
    mov     DWORD PTR _p$[ebp], 0
    mov     DWORD PTR __$SEHRec$[ebp+20], 0 ; previous try level
    push   OFFSET FLAT:$SG74605 ; 'hello #1!'
    call   _printf
    add     esp, 4
    mov     eax, DWORD PTR _p$[ebp]
    mov     DWORD PTR [eax], 13
    push   OFFSET FLAT:$SG74606 ; 'hello #2!'
    call   _printf
    add     esp, 4
    mov     DWORD PTR __$SEHRec$[ebp+20], -1 ; previous try level
    jmp     SHORT $L74616

; filter code:
$L74617:
$L74627:
    mov     ecx, DWORD PTR __$SEHRec$[ebp+4]
    mov     edx, DWORD PTR [ecx]
    mov     eax, DWORD PTR [edx]
    mov     DWORD PTR $T74621[ebp], eax
    mov     eax, DWORD PTR $T74621[ebp]
    sub     eax, -1073741819; c0000005H
    neg     eax
    sbb     eax, eax
    inc     eax
$L74619:
$L74626:
    ret     0

; handler code:
$L74618:
    mov     esp, DWORD PTR __$SEHRec$[ebp]
    push   OFFSET FLAT:$SG74608 ; 'access violation, can't recover'
    call   _printf
    add     esp, 4
    mov     DWORD PTR __$SEHRec$[ebp+20], -1 ; setting previous try level back to -1
$L74616:
    xor     eax, eax
    mov     ecx, DWORD PTR __$SEHRec$[ebp+8]
    mov     DWORD PTR fs:__except_list, ecx
    pop     edi
    pop     esi
    pop     ebx
    mov     esp, ebp
    pop     ebp
    ret     0
_main     ENDP
_TEXT     ENDS
END

```

Here we see how the SEH frame is constructed in the stack. The *scope table* is located in the CONST segment—indeed, these fields are not to be changed. An interesting thing is how the *previous try level* variable has changed. The initial value is 0xFFFFFFFF (−1). The moment when the body of the try statement is opened is marked with an instruction that writes 0 to the variable. The moment when the body of the try statement is closed, −1 is written back to it. We also see the addresses of filter and handler code.

Thus we can easily see the structure of the *try/except* constructs in the function.

Since the SEH setup code in the function prologue may be shared between many functions, sometimes the compiler inserts a call to the SEH\_prolog() function in the prologue, which does just that.

The SEH cleanup code is in the SEH\_epilog() function.

Let's try to run this example in [tracer](#):

```
tracer.exe -l:2.exe --dump-seh
```

Listing 6.28: tracer.exe output

```
EXCEPTION_ACCESS_VIOLATION at 2.exe!main+0x44 (0x401054) ExceptionInformation[0]=1
EAX=0x00000000 EBX=0x7efde000 ECX=0x0040cbc8 EDX=0x0008e3c8
ESI=0x00001db1 EDI=0x00000000 EBP=0x0018feac ESP=0x0018fe80
EIP=0x00401054
FLAGS=AF IF RF
* SEH frame at 0x18fe9c prev=0x18ff78 handler=0x401204 (2.exe!_except_handler3)
SEH3 frame. previous trylevel=0
scopetable entry[0]. previous try level=-1, filter=0x401070 (2.exe!main+0x60) handler=0x401088 ↵
  ↵ (2.exe!main+0x78)
* SEH frame at 0x18ff78 prev=0x18ffc4 handler=0x401204 (2.exe!_except_handler3)
SEH3 frame. previous trylevel=0
scopetable entry[0]. previous try level=-1, filter=0x401531 (2.exe!mainCRTStartup+0x18d) ↵
  ↵ handler=0x401545 (2.exe!mainCRTStartup+0x1a1)
* SEH frame at 0x18ffc4 prev=0x18ffe4 handler=0x771f71f5 (ntdll.dll!__except_handler4)
SEH4 frame. previous trylevel=0
SEH4 header:      GSCookieOffset=0xffffffffe GSCookieXOR0ffset=0x0
                  EHCookieOffset=0xfffffcc EHCookieXOR0ffset=0x0
scopetable entry[0]. previous try level=-2, filter=0x771f74d0 (ntdll.dll!↵
  ↵ __safe_se_handler_table+0x20) handler=0x771f90eb (ntdll.dll!_TppTerminateProcess@4+0x43)
* SEH frame at 0x18ffe4 prev=0xffffffff handler=0x77247428 (ntdll.dll!_FinalExceptionHandler@16↵
  ↵ )
```

We see that the SEH chain consists of 4 handlers.

The first two are located in our example. Two? But we made only one? Yes, another one has been set up in the [CRT](#) function `_mainCRTStartup()`, and as it seems that it handles at least [FPU](#) exceptions. Its source code can be found in the MSVC installation: `crt/src/winxfldr.c`.

The third is the SEH4 one in `ntdll.dll`, and the fourth handler is not MSVC-related and is located in `ntdll.dll`, and has a self-describing function name.

As you can see, there are 3 types of handlers in one chain:

one is not related to MSVC at all (the last one) and two MSVC-related: SEH3 and SEH4.

### SEH3: two try/except blocks example

```
#include <stdio.h>
#include <windows.h>
#include <excpt.h>

int filter_user_exceptions (unsigned int code, struct _EXCEPTION_POINTERS *ep)
{
    printf("in filter. code=0x%08X\n", code);
    if (code == 0x112233)
    {
        printf("yes, that is our exception\n");
        return EXCEPTION_EXECUTE_HANDLER;
    }
    else
    {
        printf("not our exception\n");
        return EXCEPTION_CONTINUE_SEARCH;
    }
};

int main()
{
    int* p = NULL;
    __try
```

```

{
    __try
    {
        printf ("hello!\n");
        RaiseException (0x112233, 0, 0, NULL);
        printf ("0x112233 raised. now let's crash\n");
        *p = 13;    // causes an access violation exception;
    }
    __except(GetExceptionCode()==EXCEPTION_ACCESS_VIOLATION ?
             EXCEPTION_EXECUTE_HANDLER : EXCEPTION_CONTINUE_SEARCH)
    {
        printf("access violation, can't recover\n");
    }
}
__except(filter_user_exceptions(GetExceptionCode(), GetExceptionInformation()))
{
    // the filter_user_exceptions() function answering to the question
    // "is this exception belongs to this block?"
    // if yes, do the follow:
    printf("user exception caught\n");
}
}

```

Now there are two try blocks. So the *scope table* now has two entries, one for each block. *Previous try level* changes as execution flow enters or exits the try block.

Listing 6.29: MSVC 2003

```

$SG74606 DB    'in filter. code=0x%08X', 0aH, 00H
$SG74608 DB    'yes, that is our exception', 0aH, 00H
$SG74610 DB    'not our exception', 0aH, 00H
$SG74617 DB    'hello!', 0aH, 00H
$SG74619 DB    '0x112233 raised. now let's crash', 0aH, 00H
$SG74621 DB    'access violation, can't recover', 0aH, 00H
$SG74623 DB    'user exception caught', 0aH, 00H

_code$ = 8    ; size = 4
_ep$ = 12    ; size = 4
_filter_user_exceptions PROC NEAR
    push    ebp
    mov     ebp, esp
    mov     eax, DWORD PTR _code$[ebp]
    push    eax
    push    OFFSET FLAT:$SG74606 ; 'in filter. code=0x%08X'
    call    _printf
    add     esp, 8
    cmp     DWORD PTR _code$[ebp], 1122867; 00112233H
    jne     SHORT $L74607
    push    OFFSET FLAT:$SG74608 ; 'yes, that is our exception'
    call    _printf
    add     esp, 4
    mov     eax, 1
    jmp     SHORT $L74605
$L74607:
    push    OFFSET FLAT:$SG74610 ; 'not our exception'
    call    _printf
    add     esp, 4
    xor     eax, eax
$L74605:
    pop     ebp
    ret     0
_filter_user_exceptions ENDP

; scope table:
CONST    SEGMENT
$T74644 DD    0fffffffH    ; previous try level for outer block
        DD    FLAT:$L74634 ; outer block filter
        DD    FLAT:$L74635 ; outer block handler
        DD    00H        ; previous try level for inner block
        DD    FLAT:$L74638 ; inner block filter

```

```

CONST      DD      FLAT:$L74639 ; inner block handler
           ENDS

$T74643 = -36      ; size = 4
$T74642 = -32      ; size = 4
_p$ = -28         ; size = 4
__$SEHRec$ = -24  ; size = 24
_main      PROC NEAR
    push    ebp
    mov     ebp, esp
    push    -1 ; previous try level
    push    OFFSET FLAT:$T74644
    push    OFFSET FLAT:__except_handler3
    mov     eax, DWORD PTR fs:__except_list
    push    eax
    mov     DWORD PTR fs:__except_list, esp
    add     esp, -20
    push    ebx
    push    esi
    push    edi
    mov     DWORD PTR __$SEHRec$[ebp], esp
    mov     DWORD PTR _p$[ebp], 0
    mov     DWORD PTR __$SEHRec$[ebp+20], 0 ; outer try block entered. set previous try level to
0
    mov     DWORD PTR __$SEHRec$[ebp+20], 1 ; inner try block entered. set previous try level to
1
    push    OFFSET FLAT:$SG74617 ; 'hello!'
    call    _printf
    add     esp, 4
    push    0
    push    0
    push    0
    push    1122867 ; 00112233H
    call    DWORD PTR __imp__RaiseException@16
    push    OFFSET FLAT:$SG74619 ; '0x112233 raised. now let''s crash'
    call    _printf
    add     esp, 4
    mov     eax, DWORD PTR _p$[ebp]
    mov     DWORD PTR [eax], 13
    mov     DWORD PTR __$SEHRec$[ebp+20], 0 ; inner try block exited. set previous try level back
to 0
    jmp     SHORT $L74615

; inner block filter:
$L74638:
$L74650:
    mov     ecx, DWORD PTR __$SEHRec$[ebp+4]
    mov     edx, DWORD PTR [ecx]
    mov     eax, DWORD PTR [edx]
    mov     DWORD PTR $T74643[ebp], eax
    mov     eax, DWORD PTR $T74643[ebp]
    sub     eax, -1073741819; c0000005H
    neg     eax
    sbb     eax, eax
    inc     eax
$L74640:
$L74648:
    ret     0

; inner block handler:
$L74639:
    mov     esp, DWORD PTR __$SEHRec$[ebp]
    push    OFFSET FLAT:$SG74621 ; 'access violation, can''t recover'
    call    _printf
    add     esp, 4
    mov     DWORD PTR __$SEHRec$[ebp+20], 0 ; inner try block exited. set previous try level back
to 0

$L74615:
    mov     DWORD PTR __$SEHRec$[ebp+20], -1 ; outer try block exited, set previous try level
back to -1
    jmp     SHORT $L74633

```

```

; outer block filter:
$L74634:
$L74651:
    mov     ecx, DWORD PTR __SEHRec$[ebp+4]
    mov     edx, DWORD PTR [ecx]
    mov     eax, DWORD PTR [edx]
    mov     DWORD PTR $T74642[ebp], eax
    mov     ecx, DWORD PTR __SEHRec$[ebp+4]
    push   ecx
    mov     edx, DWORD PTR $T74642[ebp]
    push   edx
    call   _filter_user_exceptions
    add     esp, 8
$L74636:
$L74649:
    ret     0

; outer block handler:
$L74635:
    mov     esp, DWORD PTR __SEHRec$[ebp]
    push   OFFSET FLAT:$SG74623 ; 'user exception caught'
    call   _printf
    add     esp, 4
    mov     DWORD PTR __SEHRec$[ebp+20], -1 ; both try blocks exited. set previous try level
    back to -1
$L74633:
    xor     eax, eax
    mov     ecx, DWORD PTR __SEHRec$[ebp+8]
    mov     DWORD PTR fs:__except_list, ecx
    pop     edi
    pop     esi
    pop     ebx
    mov     esp, ebp
    pop     ebp
    ret     0
_main     ENDP

```

If we set a breakpoint on the printf() function, which is called from the handler, we can also see how yet another SEH handler is added.

Perhaps it's another machinery inside the SEH handling process. Here we also see our *scope table* consisting of 2 entries.

```
tracer.exe -l:3.exe bpx=3.exe!printf --dump-seh
```

### Listing 6.30: tracer.exe output

```

(0) 3.exe!printf
EAX=0x0000001b EBX=0x00000000 ECX=0x0040cc58 EDX=0x0008e3c8
ESI=0x00000000 EDI=0x00000000 EBP=0x0018f840 ESP=0x0018f838
EIP=0x004011b6
FLAGS=PF ZF IF
* SEH frame at 0x18f88c prev=0x18fe9c handler=0x771db4ad (ntdll.dll!ExecuteHandler2@20+0x3a)
* SEH frame at 0x18fe9c prev=0x18ff78 handler=0x4012e0 (3.exe!_except_handler3)
SEH3 frame. previous trylevel=1
scopetable entry[0]. previous try level=-1, filter=0x401120 (3.exe!main+0xb0) handler=0x40113b ↗
↳ (3.exe!main+0xcb)
scopetable entry[1]. previous try level=0, filter=0x4010e8 (3.exe!main+0x78) handler=0x401100 ↗
↳ (3.exe!main+0x90)
* SEH frame at 0x18ff78 prev=0x18ffc4 handler=0x4012e0 (3.exe!_except_handler3)
SEH3 frame. previous trylevel=0
scopetable entry[0]. previous try level=-1, filter=0x40160d (3.exe!mainCRTStartup+0x18d) ↗
↳ handler=0x401621 (3.exe!mainCRTStartup+0x1a1)
* SEH frame at 0x18ffc4 prev=0x18ffe4 handler=0x771f71f5 (ntdll.dll!__except_handler4)
SEH4 frame. previous trylevel=0
SEH4 header:    GSCookieOffset=0xffffffff GSCookieXOROffset=0x0

```

```
EHCookieOffset=0xffffffff EHCookieXOROffset=0x0
scopetable entry[0]. previous try level=-2, filter=0x771f74d0 (ntdll.dll!
↳ __safe_se_handler_table+0x20) handler=0x771f90eb (ntdll.dll!_TppTerminateProcess@4+0x43)
* SEH frame at 0x18ffe4 prev=0xffffffff handler=0x77247428 (ntdll.dll!_FinalExceptionHandler@16
↳ )
```

## SEH4

During a buffer overflow ( [1.26.2 on page 273](#)) attack, the address of the *scope table* can be rewritten, so starting from MSVC 2005, SEH3 was upgraded to SEH4 in order to have buffer overflow protection. The pointer to the *scope table* is now **xored** with a **security cookie**. The *scope table* was extended to have a header consisting of two pointers to *security cookies*.

Each element has an offset inside the stack of another value: the address of the **stack frame** (EBP) **xored** with the `security_cookie` , placed in the stack.

This value will be read during exception handling and checked for correctness. The *security cookie* in the stack is random each time, so hopefully a remote attacker can't predict it.

The initial *previous try level* is `-2` in SEH4 instead of `-1`.

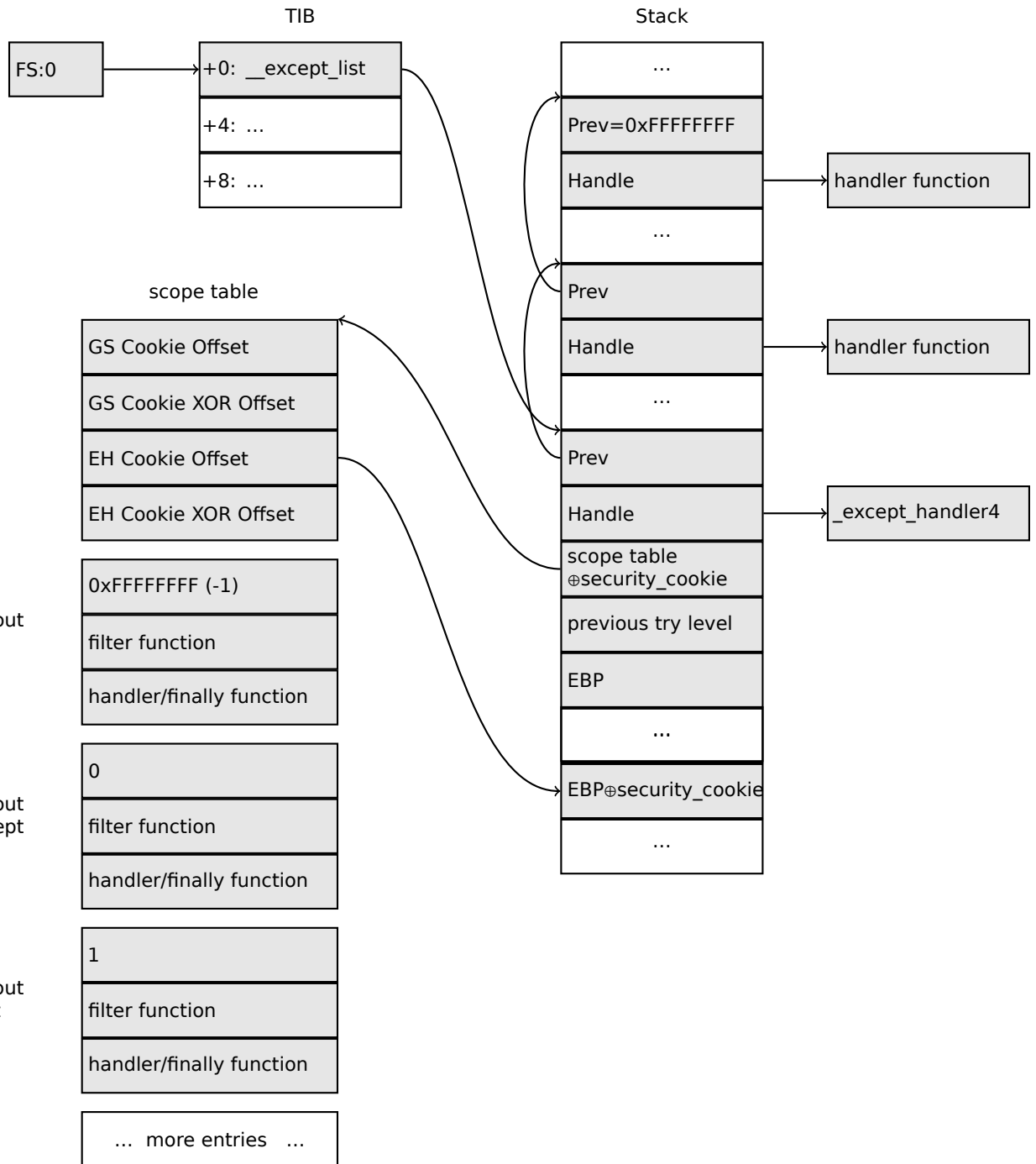

Here are both examples compiled in MSVC 2012 with SEH4:

Listing 6.31: MSVC 2012: one try block example

```

$SG85485 DB 'hello #1!', 0aH, 00H
$SG85486 DB 'hello #2!', 0aH, 00H
$SG85488 DB 'access violation, can't recover', 0aH, 00H

; scope table:
xdata$x SEGMENT
__sehtable$_main DD 0fffffffEH ; GS Cookie Offset
                DD 00H ; GS Cookie XOR Offset
                DD 0ffffffcCH ; EH Cookie Offset
                DD 00H ; EH Cookie XOR Offset
                DD 0fffffffEH ; previous try level
                DD FLAT:$LN12@main ; filter
                DD FLAT:$LN8@main ; handler
xdata$x ENDS

$T2 = -36 ; size = 4
_p$ = -32 ; size = 4
tv68 = -28 ; size = 4
__$SEHRec$ = -24 ; size = 24

```

```

_main PROC
    push    ebp
    mov     ebp, esp
    push    -2
    push    OFFSET __sehtable$_main
    push    OFFSET __except_handler4
    mov     eax, DWORD PTR fs:0
    push    eax
    add     esp, -20
    push    ebx
    push    esi
    push    edi
    mov     eax, DWORD PTR ___security_cookie
    xor     DWORD PTR __$_SEHRec$[ebp+16], eax ; xored pointer to scope table
    xor     eax, ebp
    push    eax ; ebp ^ security_cookie
    lea    eax, DWORD PTR __$_SEHRec$[ebp+8] ; pointer to VC_EXCEPTION_REGISTRATION_RECORD
    mov     DWORD PTR fs:0, eax
    mov     DWORD PTR __$_SEHRec$[ebp], esp
    mov     DWORD PTR _p$[ebp], 0
    mov     DWORD PTR __$_SEHRec$[ebp+20], 0 ; previous try level
    push    OFFSET $SG85485 ; 'hello #1!'
    call   _printf
    add     esp, 4
    mov     eax, DWORD PTR _p$[ebp]
    mov     DWORD PTR [eax], 13
    push    OFFSET $SG85486 ; 'hello #2!'
    call   _printf
    add     esp, 4
    mov     DWORD PTR __$_SEHRec$[ebp+20], -2 ; previous try level
    jmp     SHORT $LN6@main

; filter:
$LN7@main:
$LN12@main:
    mov     ecx, DWORD PTR __$_SEHRec$[ebp+4]
    mov     edx, DWORD PTR [ecx]
    mov     eax, DWORD PTR [edx]
    mov     DWORD PTR $T2[ebp], eax
    cmp     DWORD PTR $T2[ebp], -1073741819 ; c0000005H
    jne     SHORT $LN4@main
    mov     DWORD PTR tv68[ebp], 1
    jmp     SHORT $LN5@main
$LN4@main:
    mov     DWORD PTR tv68[ebp], 0
$LN5@main:
    mov     eax, DWORD PTR tv68[ebp]
$LN9@main:
$LN11@main:
    ret     0

; handler:
$LN8@main:
    mov     esp, DWORD PTR __$_SEHRec$[ebp]
    push    OFFSET $SG85488 ; 'access violation, can't recover'
    call   _printf
    add     esp, 4
    mov     DWORD PTR __$_SEHRec$[ebp+20], -2 ; previous try level
$LN6@main:
    xor     eax, eax
    mov     ecx, DWORD PTR __$_SEHRec$[ebp+8]
    mov     DWORD PTR fs:0, ecx
    pop     ecx
    pop     edi
    pop     esi
    pop     ebx
    mov     esp, ebp
    pop     ebp
    ret     0
_main ENDP

```



Listing 6.32: MSVC 2012: two try blocks example

```

$SG85486 DB 'in filter. code=0x%08X', 0aH, 00H
$SG85488 DB 'yes, that is our exception', 0aH, 00H
$SG85490 DB 'not our exception', 0aH, 00H
$SG85497 DB 'hello!', 0aH, 00H
$SG85499 DB '0x112233 raised. now let''s crash', 0aH, 00H
$SG85501 DB 'access violation, can''t recover', 0aH, 00H
$SG85503 DB 'user exception caught', 0aH, 00H

xdata$x SEGMENT
__sehtable$__main DD 0fffffffEH ; GS Cookie Offset
                  DD 00H ; GS Cookie XOR Offset
                  DD 0fffffffC8H ; EH Cookie Offset
                  DD 00H ; EH Cookie Offset
                  DD 0fffffffEH ; previous try level for outer block
                  DD FLAT:$LN19@main ; outer block filter
                  DD FLAT:$LN9@main ; outer block handler
                  DD 00H ; previous try level for inner block
                  DD FLAT:$LN18@main ; inner block filter
                  DD FLAT:$LN13@main ; inner block handler

xdata$x ENDS

$T2 = -40 ; size = 4
$T3 = -36 ; size = 4
_p$ = -32 ; size = 4
tv72 = -28 ; size = 4
__$SEHRec$ = -24 ; size = 24
_main PROC
    push ebp
    mov ebp, esp
    push -2 ; initial previous try level
    push OFFSET __sehtable$__main
    push OFFSET __except_handler4
    mov eax, DWORD PTR fs:0
    push eax ; prev
    add esp, -24
    push ebx
    push esi
    push edi
    mov eax, DWORD PTR __security_cookie
    xor DWORD PTR __SEHRec$[ebp+16], eax ; xored pointer to scope table
    xor eax, ebp ; ebp ^ security_cookie
    push eax
    lea eax, DWORD PTR __SEHRec$[ebp+8] ; pointer to VC_EXCEPTION_REGISTRATION_RECORD
    mov DWORD PTR fs:0, eax
    mov DWORD PTR __SEHRec$[ebp], esp
    mov DWORD PTR _p$[ebp], 0
    mov DWORD PTR __SEHRec$[ebp+20], 0 ; entering outer try block, setting previous try
level=0
    mov DWORD PTR __SEHRec$[ebp+20], 1 ; entering inner try block, setting previous try
level=1
    push OFFSET $SG85497 ; 'hello!'
    call _printf
    add esp, 4
    push 0
    push 0
    push 0
    push 1122867 ; 00112233H
    call DWORD PTR __imp__RaiseException@16
    push OFFSET $SG85499 ; '0x112233 raised. now let''s crash'
    call _printf
    add esp, 4
    mov eax, DWORD PTR _p$[ebp]
    mov DWORD PTR [eax], 13
    mov DWORD PTR __SEHRec$[ebp+20], 0 ; exiting inner try block, set previous try level
back to 0
    jmp SHORT $LN2@main

; inner block filter:
$LN12@main:
$LN18@main:

```

```

    mov     ecx, DWORD PTR __$SEHRec$[ebp+4]
    mov     edx, DWORD PTR [ecx]
    mov     eax, DWORD PTR [edx]
    mov     DWORD PTR $T3[ebp], eax
    cmp     DWORD PTR $T3[ebp], -1073741819 ; c0000005H
    jne     SHORT $LN5@main
    mov     DWORD PTR tv72[ebp], 1
    jmp     SHORT $LN6@main
$LN5@main:
    mov     DWORD PTR tv72[ebp], 0
$LN6@main:
    mov     eax, DWORD PTR tv72[ebp]
$LN14@main:
$LN16@main:
    ret     0

; inner block handler:
$LN13@main:
    mov     esp, DWORD PTR __$SEHRec$[ebp]
    push   OFFSET $SG85501 ; 'access violation, can''t recover'
    call   _printf
    add     esp, 4
    mov     DWORD PTR __$SEHRec$[ebp+20], 0 ; exiting inner try block, setting previous try level
    back to 0
$LN2@main:
    mov     DWORD PTR __$SEHRec$[ebp+20], -2 ; exiting both blocks, setting previous try level
    back to -2
    jmp     SHORT $LN7@main

; outer block filter:
$LN8@main:
$LN19@main:
    mov     ecx, DWORD PTR __$SEHRec$[ebp+4]
    mov     edx, DWORD PTR [ecx]
    mov     eax, DWORD PTR [edx]
    mov     DWORD PTR $T2[ebp], eax
    mov     ecx, DWORD PTR __$SEHRec$[ebp+4]
    push   ecx
    mov     edx, DWORD PTR $T2[ebp]
    push   edx
    call   _filter_user_exceptions
    add     esp, 8
$LN10@main:
$LN17@main:
    ret     0

; outer block handler:
$LN9@main:
    mov     esp, DWORD PTR __$SEHRec$[ebp]
    push   OFFSET $SG85503 ; 'user exception caught'
    call   _printf
    add     esp, 4
    mov     DWORD PTR __$SEHRec$[ebp+20], -2 ; exiting both blocks, setting previous try level
    back to -2
$LN7@main:
    xor     eax, eax
    mov     ecx, DWORD PTR __$SEHRec$[ebp+8]
    mov     DWORD PTR fs:0, ecx
    pop     ecx
    pop     edi
    pop     esi
    pop     ebx
    mov     esp, ebp
    pop     ebp
    ret     0
_main     ENDP

_code$ = 8 ; size = 4
_ep$ = 12 ; size = 4
_filter_user_exceptions PROC
    push   ebp

```

```

mov     ebp, esp
mov     eax, DWORD PTR _code$[ebp]
push   eax
push   OFFSET $SG85486 ; 'in filter. code=0x%08X'
call   _printf
add     esp, 8
cmp     DWORD PTR _code$[ebp], 1122867 ; 00112233H
jne     SHORT $LN2@filter_use
push   OFFSET $SG85488 ; 'yes, that is our exception'
call   _printf
add     esp, 4
mov     eax, 1
jmp     SHORT $LN3@filter_use
jmp     SHORT $LN3@filter_use
$LN2@filter_use:
push   OFFSET $SG85490 ; 'not our exception'
call   _printf
add     esp, 4
xor     eax, eax
$LN3@filter_use:
pop     ebp
ret     0
_filter_user_exceptions ENDP

```

Here is the meaning of the *cookies*: *Cookie Offset* is the difference between the address of the saved EBP value in the stack and the  $EBP \oplus security\_cookie$  value in the stack. *Cookie XOR Offset* is an additional difference between the  $EBP \oplus security\_cookie$  value and what is stored in the stack.

If this equation is not true, the process is to halt due to stack corruption:

$$security\_cookie \oplus (CookieXOROffset + address\_of\_saved\_EBP) == stack[address\_of\_saved\_EBP + CookieOffset]$$

If *Cookie Offset* is  $-2$ , this implies that it is not present.

*Cookies* checking is also implemented in my [tracer](#), see [GitHub](#) for details.

It is still possible to fall back to SEH3 in the compilers after (and including) MSVC 2005 by setting the `/GS-` option, however, the [CRT](#) code use SEH4 anyway.

## Windows x64

As you might think, it is not very fast to set up the SEH frame at each function prologue. Another performance problem is changing the *previous try level* value many times during the function's execution.

So things are changed completely in x64: now all pointers to try blocks, filter and handler functions are stored in another PE segment `.pdata`, and from there the OS's exception handler takes all the information.

Here are the two examples from the previous section compiled for x64:

Listing 6.33: MSVC 2012

```

$SG86276 DB      'hello #1!', 0aH, 00H
$SG86277 DB      'hello #2!', 0aH, 00H
$SG86279 DB      'access violation, can''t recover', 0aH, 00H

pdata      SEGMENT
$pdata$main DD   imagerel $LN9
            DD   imagerel $LN9+61
            DD   imagerel $unwind$main
pdata      ENDS
pdata      SEGMENT
$pdata$main$filt$0 DD imagerel main$filt$0
                DD   imagerel main$filt$0+32
                DD   imagerel $unwind$main$filt$0
pdata      ENDS
xdata      SEGMENT
$unwind$main DD  020609H
                DD   030023206H
                DD   imagerel __C_specific_handler
                DD   01H
                DD   imagerel $LN9+8

```

```

        DD    imagerel $LN9+40
        DD    imagerel main$filt$0
        DD    imagerel $LN9+40
$unwind$main$filt$0 DD 020601H
        DD    050023206H
xdata   ENDS

_TEXT   SEGMENT
main    PROC
$LN9:
        push   rbx
        sub    rsp, 32
        xor    ebx, ebx
        lea   rcx, OFFSET FLAT:$SG86276 ; 'hello #1!'
        call  printf
        mov   DWORD PTR [rbx], 13
        lea   rcx, OFFSET FLAT:$SG86277 ; 'hello #2!'
        call  printf
        jmp   SHORT $LN8@main
$LN6@main:
        lea   rcx, OFFSET FLAT:$SG86279 ; 'access violation, can't recover'
        call  printf
        npad  1 ; align next label
$LN8@main:
        xor    eax, eax
        add   rsp, 32
        pop   rbx
        ret   0
main    ENDP
_TEXT   ENDS

text$x  SEGMENT
main$filt$0 PROC
        push   rbp
        sub    rsp, 32
        mov   rbp, rdx
$LN5@main$filt$:
        mov   rax, QWORD PTR [rcx]
        xor   ecx, ecx
        cmp   DWORD PTR [rax], -1073741819; c0000005H
        sete  cl
        mov   eax, ecx
$LN7@main$filt$:
        add   rsp, 32
        pop   rbp
        ret   0
        int   3
main$filt$0 ENDP
text$x  ENDS

```

Listing 6.34: MSVC 2012

```

$SG86277 DB    'in filter. code=0x%08X', 0aH, 00H
$SG86279 DB    'yes, that is our exception', 0aH, 00H
$SG86281 DB    'not our exception', 0aH, 00H
$SG86288 DB    'hello!', 0aH, 00H
$SG86290 DB    '0x112233 raised. now let's crash', 0aH, 00H
$SG86292 DB    'access violation, can't recover', 0aH, 00H
$SG86294 DB    'user exception caught', 0aH, 00H

pdata   SEGMENT
$pdata$filter_user_exceptions DD imagerel $LN6
        DD    imagerel $LN6+73
        DD    imagerel $unwind$filter_user_exceptions
$pdata$main DD imagerel $LN14
        DD    imagerel $LN14+95
        DD    imagerel $unwind$main
pdata   ENDS
pdata   SEGMENT
$pdata$main$filt$0 DD imagerel main$filt$0

```

```

        DD      imagerel main$filt$0+32
        DD      imagerel $unwind$main$filt$0
$pdata$main$filt$1 DD imagerel main$filt$1
        DD      imagerel main$filt$1+30
        DD      imagerel $unwind$main$filt$1
pdata      ENDS

xdata      SEGMENT
$unwind$filter_user_exceptions DD 020601H
        DD      030023206H
$unwind$main DD 020609H
        DD      030023206H
        DD      imagerel __C_specific_handler
        DD      02H
        DD      imagerel $LN14+8
        DD      imagerel $LN14+59
        DD      imagerel main$filt$0
        DD      imagerel $LN14+59
        DD      imagerel $LN14+8
        DD      imagerel $LN14+74
        DD      imagerel main$filt$1
        DD      imagerel $LN14+74
$unwind$main$filt$0 DD 020601H
        DD      050023206H
$unwind$main$filt$1 DD 020601H
        DD      050023206H
xdata      ENDS

_TEXT      SEGMENT
main       PROC
$LN14:
        push    rbx
        sub     rsp, 32
        xor     ebx, ebx
        lea    rcx, OFFSET FLAT:$SG86288 ; 'hello!'
        call   printf
        xor     r9d, r9d
        xor     r8d, r8d
        xor     edx, edx
        mov     ecx, 1122867 ; 00112233H
        call   QWORD PTR __imp_RaiseException
        lea    rcx, OFFSET FLAT:$SG86290 ; '0x112233 raised. now let's crash'
        call   printf
        mov     DWORD PTR [rbx], 13
        jmp    SHORT $LN13@main
$LN11@main:
        lea    rcx, OFFSET FLAT:$SG86292 ; 'access violation, can't recover'
        call   printf
        npad   1 ; align next label
$LN13@main:
        jmp    SHORT $LN9@main
$LN7@main:
        lea    rcx, OFFSET FLAT:$SG86294 ; 'user exception caught'
        call   printf
        npad   1 ; align next label
$LN9@main:
        xor     eax, eax
        add     rsp, 32
        pop     rbx
        ret     0
main      ENDP

text$x    SEGMENT
main$filt$0 PROC
        push    rbp
        sub     rsp, 32
        mov     rbp, rdx
$LN10@main$filt$:
        mov     rax, QWORD PTR [rcx]
        xor     ecx, ecx

```

```

        cmp     DWORD PTR [rax], -1073741819; c0000005H
        sete   cl
        mov    eax, ecx
$LN12@main$filt$:
        add    rsp, 32
        pop    rbp
        ret    0
        int    3
main$filt$0 ENDP

main$filt$1 PROC
        push   rbp
        sub    rsp, 32
        mov    rbp, rdx
$LN6@main$filt$:
        mov    rax, QWORD PTR [rcx]
        mov    rdx, rcx
        mov    ecx, DWORD PTR [rax]
        call  filter_user_exceptions
        npad   1 ; align next label
$LN8@main$filt$:
        add    rsp, 32
        pop    rbp
        ret    0
        int    3
main$filt$1 ENDP
text$x ENDS

_TEXT   SEGMENT
code$ = 48
ep$ = 56
filter_user_exceptions PROC
$LN6:
        push   rbx
        sub    rsp, 32
        mov    ebx, ecx
        mov    edx, ecx
        lea   rcx, OFFSET FLAT:$SG86277 ; 'in filter. code=0x%08X'
        call  printf
        cmp    ebx, 1122867; 00112233H
        jne   SHORT $LN2@filter_use
        lea   rcx, OFFSET FLAT:$SG86279 ; 'yes, that is our exception'
        call  printf
        mov    eax, 1
        add    rsp, 32
        pop    rbx
        ret    0
$LN2@filter_use:
        lea   rcx, OFFSET FLAT:$SG86281 ; 'not our exception'
        call  printf
        xor    eax, eax
        add    rsp, 32
        pop    rbx
        ret    0
filter_user_exceptions ENDP
_TEXT   ENDS

```

Read [Igor Skochinsky, *Compiler Internals: Exceptions and RTTI*, (2012)]<sup>46</sup> for more detailed information about this.

Aside from exception information, `.pdata` is a section that contains the addresses of almost all function starts and ends, hence it may be useful for a tools targeted at automated analysis.

<sup>46</sup>Also available as <http://go.yurichev.com/17294>

## Read more about SEH

[Matt Pietrek, *A Crash Course on the Depths of Win32™ Structured Exception Handling*, (1997)]<sup>47</sup>, [Igor Skochinsky, *Compiler Internals: Exceptions and RTTI*, (2012)]<sup>48</sup>.

### 6.5.4 Windows NT: Critical section

Critical sections in any OS are very important in multithreaded environment, mostly for giving a guarantee that only one thread can access some data in a single moment of time, while blocking other threads and interrupts.

That is how a CRITICAL\_SECTION structure is declared in Windows NT line OS:

Listing 6.35: (Windows Research Kernel v1.2) public/sdk/inc/nturtl.h

```
typedef struct _RTL_CRITICAL_SECTION {
    PRTL_CRITICAL_SECTION_DEBUG DebugInfo;

    //
    // The following three fields control entering and exiting the critical
    // section for the resource
    //

    LONG LockCount;
    LONG RecursionCount;
    HANDLE OwningThread;           // from the thread's ClientId->UniqueThread
    HANDLE LockSemaphore;
    ULONG_PTR SpinCount;          // force size on 64-bit systems when packed
} RTL_CRITICAL_SECTION, *PRTL_CRITICAL_SECTION;
```

That's is how EnterCriticalSection() function works:

Listing 6.36: Windows 2008/ntdll.dll/x86 (begin)

```
_RtlEnterCriticalSection@4
var_C          = dword ptr -0Ch
var_8          = dword ptr -8
var_4          = dword ptr -4
arg_0          = dword ptr 8

        mov     edi, edi
        push   ebp
        mov   ebp, esp
        sub   esp, 0Ch
        push  esi
        push  edi
        mov   edi, [ebp+arg_0]
        lea  esi, [edi+4] ; LockCount
        mov  eax, esi
        lock btr dword ptr [eax], 0
        jnb  wait ; jump if CF=0

loc_7DE922DD:
        mov   eax, large fs:18h
        mov   ecx, [eax+24h]
        mov   [edi+0Ch], ecx
        mov  dword ptr [edi+8], 1
        pop  edi
        xor  eax, eax
        pop  esi
        mov  esp, ebp
        pop  ebp
        retn  4
```

<sup>47</sup>Also available as <http://go.yurichev.com/17293>

<sup>48</sup>Also available as <http://go.yurichev.com/17294>

... skipped

The most important instruction in this code fragment is BTR (prefixed with LOCK):

the zeroth bit is stored in the CF flag and cleared in memory. This is an [atomic operation](#),

blocking all other CPUs' access to this piece of memory (see the LOCK prefix before the BTR instruction). If the bit at LockCount is 1,

fine, reset it and return from the function: we are in a critical section.

If not—the critical section is already occupied by other thread, so wait.

The wait is performed there using WaitForSingleObject().

And here is how the LeaveCriticalSection() function works:

Listing 6.37: Windows 2008/ntdll.dll/x86 (begin)

```
_RtlLeaveCriticalSection@4 proc near
arg_0          = dword ptr 8

                mov     edi, edi
                push   ebp
                mov     ebp, esp
                push   esi
                mov     esi, [ebp+arg_0]
                add     dword ptr [esi+8], 0FFFFFFFh ; RecursionCount
                jnz     short loc_7DE922B2
                push   ebx
                push   edi
                lea     edi, [esi+4] ; LockCount
                mov     dword ptr [esi+0Ch], 0
                mov     ebx, 1
                mov     eax, edi
                lock xadd [eax], ebx
                inc     ebx
                cmp     ebx, 0FFFFFFFh
                jnz     loc_7DEA8EB7

loc_7DE922B0:
                pop     edi
                pop     ebx

loc_7DE922B2:
                xor     eax, eax
                pop     esi
                pop     ebp
                retn    4

... skipped
```

XADD is “exchange and add”.

In this case, it adds 1 to LockCount, meanwhile saves initial value of LockCount in the EBX register. However, value in EBX is to incremented with a help of subsequent INC EBX, and it also will be equal to the updated value of LockCount.

This operation is atomic since it is prefixed by LOCK as well, meaning that all other CPUs or CPU cores in system are blocked from accessing this point in memory.

The LOCK prefix is very important:

without it two threads, each of which works on separate CPU or CPU core can try to enter a critical section and to modify the value in memory, which will result in non-deterministic behavior.



# Chapter 7

## Tools

Now that Dennis Yurichev has made this book free (libre), it is a contribution to the world of free knowledge and free education. However, for our freedom's sake, we need free (libre) reverse engineering tools to replace the proprietary tools described in this book.

---

Richard M. Stallman

### 7.1 Binary analysis

Tools you use when you don't run any process.

- (Free, open-source) *ent*<sup>1</sup>: entropy analyzing tool. Read more about entropy: [9.2 on page 944](#).
- *Hiew*<sup>2</sup>: for small modifications of code in binary files. Has assembler/disassembler.
- (Free, open-source) *GHex*<sup>3</sup>: simple hexadecimal editor for Linux.
- (Free, open-source) *xxd* and *od*: standard UNIX utilities for dumping.
- (Free, open-source) *strings*: \*NIX tool for searching for ASCII strings in binary files, including executable ones. Sysinternals has alternative<sup>4</sup> supporting wide char strings (UTF-16, widely used in Windows).
- (Free, open-source) *Binwalk*<sup>5</sup>: analyzing firmware images.
- (Free, open-source) *binary grep*: a small utility for searching any byte sequence in a big pile of files, including non-executable ones: [GitHub](#). There is also *rafind2* in *rada.re* for the same purpose.

#### 7.1.1 Disassemblers

- *IDA*. An older freeware version is available for download <sup>6</sup>. Hot-keys cheatsheet: [.6.1 on page 1044](#)
- *Ghidra*<sup>7</sup> — free alternative to IDA from [NSA](#).
- *Binary Ninja*<sup>8</sup>
- (Free, open-source) *zynamics BinNavi*<sup>9</sup>
- (Free, open-source) *objdump*: simple command-line utility for dumping and disassembling.
- (Free, open-source) *readelf*<sup>10</sup>: dump information about ELF file.

---

<sup>1</sup><http://www.fourmilab.ch/random/>

<sup>2</sup>[hiew.ru](http://hiew.ru)

<sup>3</sup><https://wiki.gnome.org/Apps/Ghex>

<sup>4</sup><https://technet.microsoft.com/en-us/sysinternals/strings>

<sup>5</sup><http://binwalk.org/>

<sup>6</sup>[hex-rays.com/products/ida/support/download\\_freeware.shtml](http://hex-rays.com/products/ida/support/download_freeware.shtml)

<sup>7</sup><https://ghidra-sre.org/>

<sup>8</sup><http://binary.ninja/>

<sup>9</sup><https://www.zynamics.com/binnavi.html>

<sup>10</sup><https://sourceware.org/binutils/docs/binutils/readelf.html>

## 7.1.2 Decompilers

The best known is *Hex-Rays*: <http://hex-rays.com/products/decompiler/>. Read more about it: [11.8 on page 1002](#).

There is also a free alternative from NSA: *Ghidra*<sup>11</sup>.

## 7.1.3 Patch comparison/diffing

You may want to use it when you compare original version of some executable and patched one, in order to find what has been patched and why.

- (Free) *zynamics BinDiff*<sup>12</sup>
- (Free, open-source) *Diaphora*<sup>13</sup>

## 7.2 Live analysis

Tools you use on a live system or during running of a process.

### 7.2.1 Debuggers

- (Free) *OllyDbg*. Very popular user-mode win32 debugger<sup>14</sup>. Hot-keys cheatsheet: [.6.2 on page 1045](#)
- (Free, open-source) *GDB*. Not quite popular debugger among reverse engineers, because it's intended mostly for programmers. Some commands: [.6.5 on page 1046](#). There is a visual interface for GDB, "GDB dashboard"<sup>15</sup>.
- (Free, open-source) *LLDB*<sup>16</sup>.
- *WinDbg*<sup>17</sup>: kernel debugger for Windows.
- *IDA* has internal debugger.
- (Free, open-source) *Radare* AKA [rada.re](http://rada.re) AKA *r2*<sup>18</sup>. A GUI also exists: *ragui*<sup>19</sup>.
- (Free, open-source) *tracer*. The author often uses *tracer*<sup>20</sup> instead of a debugger.

The author of these lines stopped using a debugger eventually, since all he needs from it is to spot function arguments while executing, or registers state at some point. Loading a debugger each time is too much, so a small utility called *tracer* was born. It works from command line, allows intercepting function execution, setting breakpoints at arbitrary places, reading and changing registers state, etc.

N.B.: the *tracer* isn't evolving, because it was developed as a demonstration tool for this book, not as everyday tool.

### 7.2.2 Library calls tracing

*ltrace*<sup>21</sup>.

### 7.2.3 System calls tracing

**strace / dtruss**

It shows which system calls (syscalls( [6.3 on page 749](#))) are called by a process right now.

For example:

---

<sup>11</sup><https://ghidra-sre.org/>

<sup>12</sup><https://www.zynamics.com/software.html>

<sup>13</sup><https://github.com/joxeankoret/diaphora>

<sup>14</sup>[ollydbg.de](http://ollydbg.de)

<sup>15</sup><https://github.com/cyrus-and/gdb-dashboard>

<sup>16</sup><http://lldb.lldb.org/>

<sup>17</sup><https://developer.microsoft.com/en-us/windows/hardware/windows-driver-kit>

<sup>18</sup><http://rada.re/r/>

<sup>19</sup><http://radare.org/ragui/>

<sup>20</sup>[yurichev.com](http://yurichev.com)

<sup>21</sup><http://www.ltrace.org/>

```
# strace df -h
...
access("/etc/ld.so.nohwcap", F_OK) = -1 ENOENT (No such file or directory)
open("/lib/i386-linux-gnu/libc.so.6", O_RDONLY|O_CLOEXEC) = 3
read(3, "\177ELF\1\1\1\0\0\0\0\0\0\0\0\0\3\0\3\0\1\0\0\0\220\232\1\0004\0\0\0"... , 512) = 512
fstat64(3, {st_mode=S_IFREG|0755, st_size=1770984, ...}) = 0
mmap2(NULL, 1780508, PROT_READ|PROT_EXEC, MAP_PRIVATE|MAP_DENYWRITE, 3, 0) = 0xb75b3000
```

Mac OS X has `dtruss` for doing the same.

Cygwin also has `strace`, but as far as it's known, it works only for `.exe`-files compiled for the cygwin environment itself.

## 7.2.4 Network sniffing

*Sniffing* is intercepting some information you may be interested in.

(Free, open-source) *Wireshark*<sup>22</sup> for network sniffing. It has also capability for USB sniffing<sup>23</sup>.

Wireshark has a younger (or older) brother *tcpdump*<sup>24</sup>, simpler command-line tool.

## 7.2.5 Sysinternals

(Free) Sysinternals (developed by Mark Russinovich)<sup>25</sup>. At least these tools are important and worth studying: Process Explorer, Handle, VMMap, TCPView, Process Monitor.

## 7.2.6 Valgrind

(Free, open-source) a powerful tool for detecting memory leaks: <http://valgrind.org/>. Due to its powerful *JIT* mechanism, Valgrind is used as a framework for other tools.

## 7.2.7 Emulators

- (Free, open-source) *QEMU*<sup>26</sup>: emulator for various CPUs and architectures.
- (Free, open-source) *DosBox*<sup>27</sup>: MS-DOS emulator, mostly used for retrogaming.
- (Free, open-source) *SimH*<sup>28</sup>: emulator of ancient computers, mainframes, etc.

## 7.3 Other tools

*Microsoft Visual Studio Express*<sup>29</sup>: Stripped-down free version of Visual Studio, convenient for simple experiments.

Some useful options: [.6.3 on page 1045](#).

There is a website named “Compiler Explorer”, allowing to compile small code snippets and see output in various GCC versions and architectures (at least x86, ARM, MIPS): <http://godbolt.org/>—I would have used it myself for the book if I would know about it!

### 7.3.1 SMT solvers

From the reverse engineer's perspective, SMT solvers are used when dealing with amateur cryptography, symbolic/concolic execution, ROP chains generation.

For more information, read: [https://yurichev.com/writings/SAT\\_SMT\\_by\\_example.pdf](https://yurichev.com/writings/SAT_SMT_by_example.pdf).

<sup>22</sup><https://www.wireshark.org/>

<sup>23</sup><https://wiki.wireshark.org/CaptureSetup/USB>

<sup>24</sup><http://www.tcpdump.org/>

<sup>25</sup><https://technet.microsoft.com/en-us/sysinternals/bb842062>

<sup>26</sup><http://qemu.org>

<sup>27</sup><https://www.dosbox.com/>

<sup>28</sup><http://simh.trailing-edge.com/>

<sup>29</sup>[visualstudio.com/en-US/products/visual-studio-express-vs](https://visualstudio.com/en-US/products/visual-studio-express-vs)

### 7.3.2 Calculators

Good calculator for reverse engineer's needs should support at least decimal, hexadecimal and binary bases, as well as many important operations like XOR and shifts.

- IDA has built-in calculator (“?”).
- rada.re has *rax2*.
- <https://yurichev.com/progcalc/>
- As a last resort, standard calculator in Windows has programmer's mode.

## 7.4 Do You Think Something Is Missing Here?

If you know a great tool not listed here, please drop a note:

<first at last dot com> or <first dot last at gmail dot com>.

# Chapter 8

## Case studies

Instead of epigraph:

**Peter Seibel:** How do you tackle reading source code? Even reading something in a programming language you already know is a tricky problem.

**Donald Knuth:** But it's really worth it for what it builds in your brain. So how do I do it? There was a machine called the Bunker Ramo 300 and somebody told me that the Fortran compiler for this machine was really amazingly fast, but nobody had any idea why it worked. I got a copy of the source-code listing for it. I didn't have a manual for the machine, so I wasn't even sure what the machine language was.

But I took it as an interesting challenge. I could figure out BEGIN and then I would start to decode. The operation codes had some two-letter mnemonics and so I could start to figure out "This probably was a load instruction, this probably was a branch." And I knew it was a Fortran compiler, so at some point it looked at column seven of a card, and that was where it would tell if it was a comment or not.

After three hours I had figured out a little bit about the machine. Then I found these big, branching tables. So it was a puzzle and I kept just making little charts like I'm working at a security agency trying to decode a secret code. But I knew it worked and I knew it was a Fortran compiler—it wasn't encrypted in the sense that it was intentionally obscure; it was only in code because I hadn't gotten the manual for the machine.

Eventually I was able to figure out why this compiler was so fast. Unfortunately it wasn't because the algorithms were brilliant; it was just because they had used unstructured programming and hand optimized the code to the hilt.

It was just basically the way you solve some kind of an unknown puzzle— make tables and charts and get a little more information here and make a hypothesis. In general when I'm reading a technical paper, it's the same challenge. I'm trying to get into the author's mind, trying to figure out what the concept is. The more you learn to read other people's stuff, the more able you are to invent your own in the future, it seems to me.

( Peter Seibel — Coders at Work: Reflections on the Craft of Programming )

### 8.1 Mahjong solitaire prank (Windows 7)

Mahjong solitaire is a great game, but can we make it harder, by disabling the *Hint* menu item?

In my Windows 7, I can find Mahjong.dll and Mahjong.exe in:

```
C:\Windows\winsxs\  
x86_microsoft-windows-s...inboxgames-shanghai_31bf3856ad364e35_6.1.7600.16385_none\  
c07a51d9507d9398.
```

Also, the Mahjong.exe.mui file in:

```
C:\Windows\winsxs\  
x86_microsoft-windows-s...-shanghai.resources_31bf3856ad364e35_6.1.7600.16385_en-us  
_c430954533c66bf3
```

and

```
C:\Windows\winsxs\  
x86_microsoft-windows-s...-shanghai.resources_31bf3856ad364e35_6.1.7600.16385_ru-ru
```

\_0d51acf984cb679a.

I'm using English Windows, but with Russian language support, so there are might be resource files for two languages. By opening Mahjong.exe.mui in Resource Hacker, there we can see a menu definition:

Listing 8.1: Menu resources from Mahjong.exe.mui

```
103 MENU
LANGUAGE LANG_ENGLISH, SUBLANG_ENGLISH_US
{
  POPUP "&Game"
  {
    MENUITEM "&New Game\tF2", 40000
    MENUITEM SEPARATOR
    MENUITEM "&Undo\tCtrl+Z", 40001
    MENUITEM "&Hint\tH", 40002
    MENUITEM SEPARATOR
    MENUITEM "&Statistics\tF4", 40003
    MENUITEM "&Options\tF5", 40004
    MENUITEM "Change &Appearance\tF7", 40005
    MENUITEM SEPARATOR
    MENUITEM "E&xit", 40006
  }
  POPUP "&Help"
  {
    MENUITEM "&View Help\tF1", 40015
    MENUITEM "&About Mahjong Titans", 40016
    MENUITEM SEPARATOR
    MENUITEM "Get &More Games Online", 40020
  }
}
```

The *Hint* submenu has the 40002 code. Now I'm opening Mahjong.exe in IDA and find the 40002 value. (I'm writing this in November 2019. Somehow, IDA can't get PDBs from Microsoft servers. Maybe Windows 7 is unsupported anymore? Anyway, I can't get function names...)

Listing 8.2: Mahjong.exe

```
.text:010205C8 6A 03          push    3
.text:010205CA 85 FF          test   edi, edi
.text:010205CC 5B             pop    ebx

...

.text:01020625 57             push   edi                ; uIDEnableItem
.text:01020626 FF 35 C8 97 08 01    push   hmenu              ; hMenu
.text:0102062C FF D6          call   esi ; EnableMenuItem
.text:0102062E 83 7D 08 01    cmp    [ebp+arg_0], 1
.text:01020632 BF 42 9C 00 00    mov    edi, 40002
.text:01020637 75 18          jnz    short loc_1020651 ; must be always
.text:01020639 6A 00          push   0                  ; uEnable
.text:0102063B 57             push   edi                ; uIDEnableItem
.text:0102063C FF 35 B4 8B 08 01    push   hMenu              ; hMenu
.text:01020642 FF D6          call   esi ; EnableMenuItem
.text:01020644 6A 00          push   0                  ; uEnable
.text:01020646 57             push   edi                ; uIDEnableItem
.text:01020647 FF 35 C8 97 08 01    push   hmenu              ; hMenu
.text:0102064D FF D6          call   esi ; EnableMenuItem
.text:0102064F EB 1A          jmp    short loc_102066B
.text:01020651                                     ;
-----
.text:01020651                                     ;
.text:01020651                                     loc_1020651:                ; CODE XREF:
                sub_1020581+B6
.text:01020651 53             push   ebx                ; 3
.text:01020652 57             push   edi                ; uIDEnableItem
.text:01020653 FF 35 B4 8B 08 01    push   hMenu              ; hMenu
.text:01020659 FF D6          call   esi ; EnableMenuItem
```

.text:0102065B 53	push	ebx	; 3
.text:0102065C 57	push	edi	; uIDEnableItem
.text:0102065D FF 35 C8 97 08 01	push	hmenu	; hMenu
.text:01020663 FF D6	call	esi	; EnableMenuItem

This piece of code enables or disables the *Hint* menu item.

And according to MSDN<sup>1</sup>:

MF\_DISABLED | MF\_GRAYED = 3 and MF\_ENABLED = 0.

I think, this function enables or disables several menu items (*Hint*, *Undo*, etc), according to the value in `arg_0`. Because at start, when a user choose solitaire type, *Hint* and *Undo* are disabled. They are enabled when the game has begun.

So I'm patching the Mahjong.exe file at 0x01020637 by replacing 0x75 with 0xEB byte, making this JNZ jump working always. Effectively, this will make calling `EnableMenuItem(..., ..., 3)` always. Now the *Hint* submenu is always disabled.

Also, somehow, `EnableMenuItem()` called twice, for `hMenu` and for `hmenu`. Perhaps, the program has two menus, and maybe switching them?

As a homework, try to disable *Undo* menu item, to make the game even harder.

## 8.2 Task manager practical joke (Windows Vista)

Let's see if it's possible to hack Task Manager slightly so it would detect more CPU cores.

Let us first think, how does the Task Manager know the number of cores?

There is the `GetSystemInfo()` win32 function present in win32 userspace which can tell us this. But it's not imported in `taskmgr.exe`.

There is, however, another one in [NTAPI](#), `NtQuerySystemInformation()`, which is used in `taskmgr.exe` in several places.

To get the number of cores, one has to call this function with the `SystemBasicInformation` constant as a first argument (which is zero <sup>2</sup>).

The second argument has to point to the buffer which is getting all the information.

So we have to find all calls to the `NtQuerySystemInformation(0, ?, ?, ?)` function. Let's open `taskmgr.exe` in IDA.

What is always good about Microsoft executables is that IDA can download the corresponding [PDB](#) file for this executable and show all function names.

It is visible that Task Manager is written in C++ and some of the function names and classes are really speaking for themselves. There are classes `CAdapter`, `CNetPage`, `CPerfPage`, `CProcInfo`, `CProcPage`, `CSvcPage`, `CTaskPage`, `CUserPage`.

Apparently, each class corresponds to each tab in Task Manager.

Let's visit each call and add comment with the value which is passed as the first function argument. We will write "not zero" at some places, because the value there was clearly not zero, but something really different (more about this in the second part of this chapter).

And we are looking for zero passed as argument, after all.

<sup>1</sup><https://docs.microsoft.com/en-us/windows/win32/api/winuser/nf-winuser-enablemenuitem>

<sup>2</sup>MSDN

Dire...	T.	Address	Text
Up	p	wWinMain+50E	call cs:__imp_NtQuerySystemInformation; 0
Up	p	wWinMain+542	call cs:__imp_NtQuerySystemInformation; 2
Up	p	CPerfPage::TimerEvent(void)+200	call cs:__imp_NtQuerySystemInformation; not zero
	p	InitPerfInfo(void)+2C	call cs:__imp_NtQuerySystemInformation; 0
D...	p	InitPerfInfo(void)+F0	call cs:__imp_NtQuerySystemInformation; 8
D...	p	CalcCpuTime(int)+5F	call cs:__imp_NtQuerySystemInformation; 8
D...	p	CalcCpuTime(int)+248	call cs:__imp_NtQuerySystemInformation; 2
D...	p	CPerfPage::CalcPhysicalMem(unsigned ...	call cs:__imp_NtQuerySystemInformation; not zero
D...	p	CPerfPage::CalcPhysicalMem(unsigned ...	call cs:__imp_NtQuerySystemInformation; not zero
D...	p	CProcPage::GetProcessInfo(void)+2B	call cs:__imp_NtQuerySystemInformation; 5
D...	p	CProcPage::UpdateProcInfoArray(void)+...	call cs:__imp_NtQuerySystemInformation; 0
D...	p	CProcPage::UpdateProcInfoArray(void)+...	call cs:__imp_NtQuerySystemInformation; 2
D...	p	CProcPage::Initialize(HWND__*)+201	call cs:__imp_NtQuerySystemInformation; 0
D...	p	CProcPage::GetTaskListEx(void)+3C	call cs:__imp_NtQuerySystemInformation; 5

Figure 8.1: IDA: cross references to NtQuerySystemInformation()

Yes, the names are really speaking for themselves.

When we closely investigate each place where

NtQuerySystemInformation(0, ?, ?, ?) is called, we quickly find what we need in the InitPerfInfo() function:

Listing 8.3: taskmgr.exe (Windows Vista)

.text:10000B4B3	xor	r9d, r9d	
.text:10000B4B6	lea	rdx, [rsp+0C78h+var_C58] ; buffer	
.text:10000B4BB	xor	ecx, ecx	
.text:10000B4BD	lea	ebp, [r9+40h]	
.text:10000B4C1	mov	r8d, ebp	
.text:10000B4C4	call	cs:__imp_NtQuerySystemInformation ; 0	
.text:10000B4CA	xor	ebx, ebx	
.text:10000B4CC	cmp	eax, ebx	
.text:10000B4CE	jge	short loc_10000B4D7	
.text:10000B4D0			
.text:10000B4D0	loc_10000B4D0:		; CODE XREF: InitPerfInfo(void)+97
.text:10000B4D0			; InitPerfInfo(void)+AF
.text:10000B4D0	xor	al, al	
.text:10000B4D2	jmp	loc_10000B5EA	
.text:10000B4D7	; -----		
.text:10000B4D7	loc_10000B4D7:		; CODE XREF: InitPerfInfo(void)+36
.text:10000B4D7	mov	eax, [rsp+0C78h+var_C50]	
.text:10000B4DB	mov	esi, ebx	
.text:10000B4DD	mov	r12d, 3E80h	
.text:10000B4E3	mov	cs:?g_PageSize@@3KA, eax ; ulong g_PageSize	
.text:10000B4E9	shr	eax, 0Ah	
.text:10000B4EC	lea	r13, __ImageBase	
.text:10000B4F3	imul	eax, [rsp+0C78h+var_C4C]	
.text:10000B4F8	cmp	[rsp+0C78h+var_C20], bpl	
.text:10000B4FD	mov	cs:?g_MEMMax@@3_JA, rax ; __int64 g_MEMMax	
.text:10000B504	movzx	eax, [rsp+0C78h+var_C20] ; number of CPUs	
.text:10000B509	cmova	eax, ebp	
.text:10000B50C	cmp	al, bl	
.text:10000B50E	mov	cs:?g_cProcessors@@3EA, al ; uchar g_cProcessors	

g\_cProcessors is a global variable, and this name has been assigned by IDA according to the PDB loaded from Microsoft's symbol server.



The byte is taken from var\_C20. And var\_C58 is passed to NtQuerySystemInformation() as a pointer to the receiving buffer. The difference between 0xC20 and 0xC58 is 0x38 (56).

Let's take a look at format of the return structure, which we can find in MSDN:

```
typedef struct _SYSTEM_BASIC_INFORMATION {
    BYTE Reserved1[24];
    PVOID Reserved2[4];
    CCHAR NumberOfProcessors;
} SYSTEM_BASIC_INFORMATION;
```

This is a x64 system, so each PVOID takes 8 bytes.

All reserved fields in the structure take  $24 + 4 * 8 = 56$  bytes.

Oh yes, this implies that var\_C20 in the local stack is exactly the NumberOfProcessors field of the SYSTEM\_BASIC\_INFORMATION structure.

Let's check our guess. Copy taskmgr.exe from C:\Windows\System32 to some other folder (so the Windows Resource Protection will not try to restore the patched taskmgr.exe).

Let's open it in Hiew and find the place:

```
01`0000B4F8: 40386C2458      cmp     [rsp][058],bp1
01`0000B4FD: 48890544A00100  mov     [00000001`00025548],rax
01`0000B504: 0FB6442458      movzx   eax,b,[rsp][058]
01`0000B509: 0F47C5          cmova   eax,ebp
01`0000B50C: 3AC3           cmp     al,b1
01`0000B50E: 880574950100   mov     [00000001`00024A88],al
01`0000B514: 7645           jbe     .00000001`0000B55B --□3
01`0000B516: 488BFB         mov     rdi,rbx
01`0000B519: 498BD4         5mov    rdx,r12
01`0000B51C: 8BCD           mov     ecx,ebp
```

Figure 8.2: Hiew: find the place to be patched

Let's replace the MOVZX instruction with ours. Let's pretend we've got 64 CPU cores.

Add one additional NOP (because our instruction is shorter than the original one):

```
00`0000A8F8: 40386C2458      cmp     [rsp][058],bp1
00`0000A8FD: 48890544A00100  mov     [000024948],rax
00`0000A904: 66B84000        mov     ax,00040 ; '@'
00`0000A908: 90              nop
00`0000A909: 0F47C5          cmova   eax,ebp
00`0000A90C: 3AC3           cmp     al,b1
00`0000A90E: 880574950100   mov     [000023E88],al
00`0000A914: 7645           jbe     0000A95B
00`0000A916: 488BFB         mov     rdi,rbx
00`0000A919: 498BD4         mov     rdx,r12
00`0000A91C: 8BCD           mov     ecx,ebp
```

Figure 8.3: Hiew: patch it

And it works! Of course, the data in the graphs is not correct.

At times, Task Manager even shows an overall CPU load of more than 100%.

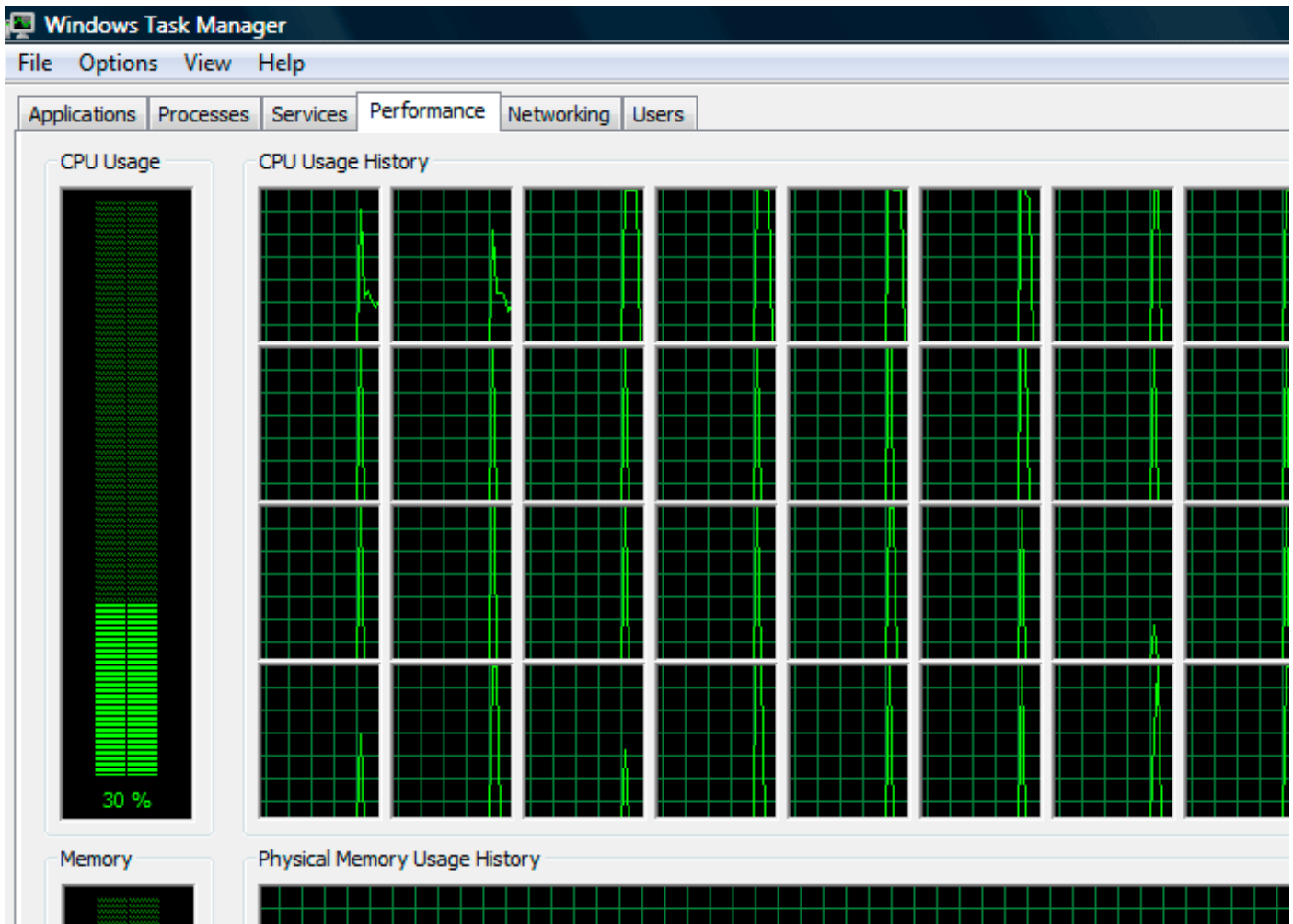

Figure 8.4: Fooled Windows Task Manager

The biggest number Task Manager does not crash with is 64.

Apparently, Task Manager in Windows Vista was not tested on computers with a large number of cores. So there are probably some static data structure(s) inside it limited to 64 cores.

### 8.2.1 Using LEA to load values

Sometimes, LEA is used in taskmgr.exe instead of MOV to set the first argument of NtQuerySystemInformation():

Listing 8.4: taskmgr.exe (Windows Vista)

```

xor     r9d, r9d
div     dword ptr [rsp+4C8h+WndClass.lpfWndProc]
lea     rdx, [rsp+4C8h+VersionInformation]
lea     ecx, [r9+2]      ; put 2 to ECX
mov     r8d, 138h
mov     ebx, eax
; ECX=SystemPerformanceInformation
call    cs:__imp_NtQuerySystemInformation ; 2

...

mov     r8d, 30h
lea     r9, [rsp+298h+var_268]
lea     rdx, [rsp+298h+var_258]
lea     ecx, [r8-2Dh]   ; put 3 to ECX
; ECX=SystemTimeOfDayInformation
call    cs:__imp_NtQuerySystemInformation ; not zero

```

```

...
mov     rbp, [rsi+8]
mov     r8d, 20h
lea     r9, [rsp+98h+arg_0]
lea     rdx, [rsp+98h+var_78]
lea     ecx, [r8+2Fh] ; put 0x4F to ECX
mov     [rsp+98h+var_60], ebx
mov     [rsp+98h+var_68], rbp
; ECX=SystemSuperfetchInformation
call    cs:__imp_NtQuerySystemInformation ; not zero

```

Perhaps [MSVC](#) did so because machine code of LEA is shorter than MOV REG, 5 (would be 5 instead of 4). LEA with offset in -128..127 range (offset will occupy 1 byte in opcode) with 32-bit registers is even shorter (for lack of REX prefix)—3 bytes.

Another example of such thing is: [6.1.5 on page 740](#).

### 8.3 Color Lines game practical joke

This is a very popular game with several implementations in existence. We can take one of them, called BallTriX, from 1997, available freely at <http://go.yurichev.com/17311><sup>3</sup>. Here is how it looks:

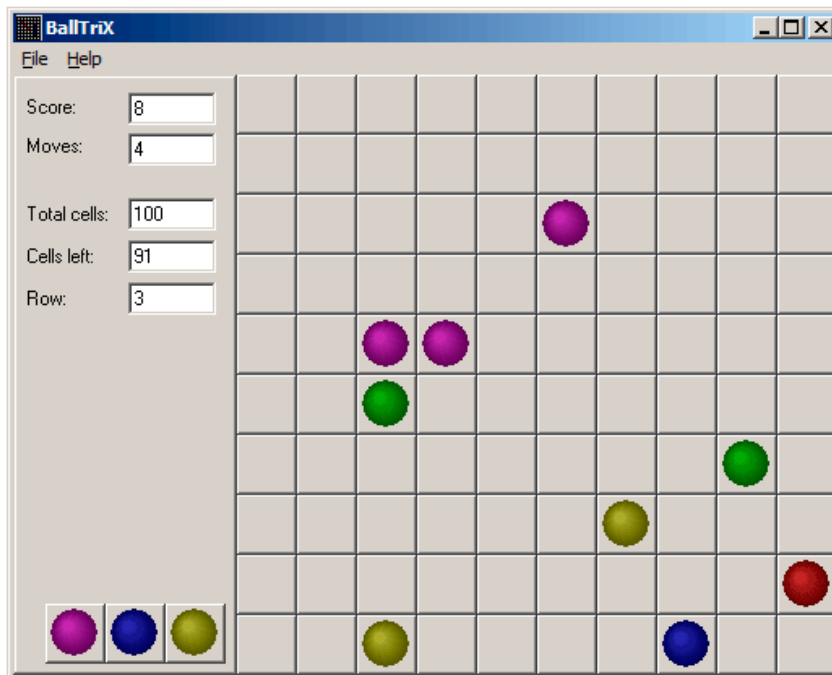

Figure 8.5: This is how the game is usually looks like

<sup>3</sup>Or at <http://go.yurichev.com/17365> or <http://go.yurichev.com/17366>.

So let's see, is it possible to find the random generator and do some trick with it. IDA quickly recognizes the standard `_rand` function in `balltrix.exe` at `0x00403DA0`. IDA also shows that it is called only from one place:

```
.text:00402C9C sub_402C9C      proc near                ; CODE XREF: sub_402ACA+52
.text:00402C9C                                     ; sub_402ACA+64 ...
.text:00402C9C arg_0          = dword ptr 8
.text:00402C9C                                     push    ebp
.text:00402C9D                                     mov     ebp, esp
.text:00402C9F                                     push    ebx
.text:00402CA0                                     push    esi
.text:00402CA1                                     push    edi
.text:00402CA2                                     mov     eax, dword_40D430
.text:00402CA7                                     imul   eax, dword_40D440
.text:00402CAE                                     add     eax, dword_40D5C8
.text:00402CB4                                     mov     ecx, 32000
.text:00402CB9                                     cdq
.text:00402CBA                                     idiv   ecx
.text:00402CBC                                     mov     dword_40D440, edx
.text:00402CC2                                     call   _rand
.text:00402CC7                                     cdq
.text:00402CC8                                     idiv   [ebp+arg_0]
.text:00402CCB                                     mov     dword_40D430, edx
.text:00402CD1                                     mov     eax, dword_40D430
.text:00402CD6                                     jmp     $+5
.text:00402CDB                                     pop     edi
.text:00402CDC                                     pop     esi
.text:00402CDD                                     pop     ebx
.text:00402CDE                                     leave
.text:00402CDF                                     retn
.text:00402CDF sub_402C9C      endp
```

We'll call it "random". Let's not dive into this function's code yet.

This function is referred from 3 places.

Here are the first two:

```
.text:00402B16                                     mov     eax, dword_40C03C ; 10 here
.text:00402B1B                                     push   eax
.text:00402B1C                                     call   random
.text:00402B21                                     add     esp, 4
.text:00402B24                                     inc     eax
.text:00402B25                                     mov     [ebp+var_C], eax
.text:00402B28                                     mov     eax, dword_40C040 ; 10 here
.text:00402B2D                                     push   eax
.text:00402B2E                                     call   random
.text:00402B33                                     add     esp, 4
```

Here is the third one:

```
.text:00402BBB                                     mov     eax, dword_40C058 ; 5 here
.text:00402BC0                                     push   eax
.text:00402BC1                                     call   random
.text:00402BC6                                     add     esp, 4
.text:00402BC9                                     inc     eax
```

So the function has only one argument.

10 is passed in first two cases and 5 in third. We can also notice that the board has a size of 10\*10 and there are 5 possible colors. This is it! The standard `rand()` function returns a number in the `0..0x7FFF` range and this is often inconvenient, so many programmers implement their own random functions which returns a random number in a specified range. In our case, the range is  $0..n-1$  and  $n$  is passed as the sole argument of the function. We can quickly check this in any debugger.

So let's fix the third function call to always return zero. First, we will replace three instructions (PUSH/CALL/ADD) by NOPS. Then we'll add `XOR EAX, EAX` instruction, to clear the EAX register.

```
.00402BB8: 83C410      add     esp,010
.00402BBB: A158C04000  mov     eax,[00040C058]
.00402BC0: 31C0       xor     eax,eax
.00402BC2: 90        nop
.00402BC3: 90        nop
.00402BC4: 90        nop
.00402BC5: 90        nop
.00402BC6: 90        nop
.00402BC7: 90        nop
.00402BC8: 90        nop
.00402BC9: 40        inc     eax
.00402BCA: 8B4DF8     mov     ecx,[ebp][-8]
.00402BCD: 8D0C49     lea    ecx,[ecx][ecx]*2
.00402BD0: 8B15F4D54000  mov     edx,[00040D5F4]
```

So what we did is we replaced a call to the `random()` function by a code which always returns zero.

Let's run it now:

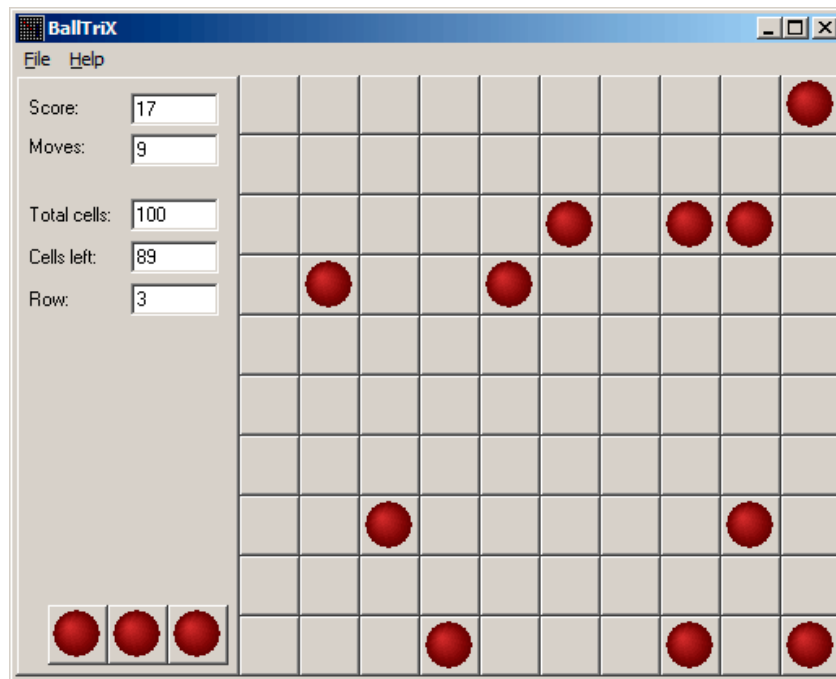

Figure 8.6: Practical joke works

Oh yes, it works<sup>4</sup>.

But why are the arguments to the `random()` functions global variables? That's just because it's possible to change the board size in the game's settings, so these values are not hardcoded. The 10 and 5 values are just defaults.

## 8.4 Minesweeper (Windows XP)

For those who are not very good at playing Minesweeper, we could try to reveal the hidden mines in the debugger.

As we know, Minesweeper places mines randomly, so there has to be some kind of random number generator or a call to the standard `rand()` C-function.

What is really cool about reversing Microsoft products is that there are `PDB` file with symbols (function names, etc). When we load `winmine.exe` into `IDA`, it downloads the `PDB` file exactly for this executable and shows all names.

So here it is, the only call to `rand()` is this function:

```
.text:01003940 ; __stdcall Rnd(x)
.text:01003940 _Rnd@4      proc near          ; CODE XREF: StartGame()+53
.text:01003940                                     ; StartGame()+61
.text:01003940
.text:01003940 arg_0          = dword ptr 4
.text:01003940
.text:01003940 call     ds:__imp__rand
.text:01003946 cdq
.text:01003947 idiv    [esp+arg_0]
.text:0100394B mov     eax, edx
.text:0100394D retn    4
.text:0100394D _Rnd@4      endp
```

`IDA` named it so, and it was the name given to it by Minesweeper's developers.

The function is very simple:

<sup>4</sup>Author of this book once did this as a joke for his coworkers with the hope that they would stop playing. They didn't.

```
int Rnd(int limit)
{
    return rand() % limit;
};
```

(There is no “limit” name in the PDB file; we manually named this argument like this.)

So it returns a random value from 0 to a specified limit.

Rnd() is called only from one place, a function called StartGame(), and as it seems, this is exactly the code which place the mines:

```
.text:010036C7      push    _xBoxMac
.text:010036CD      call   _Rnd@4          ; Rnd(x)
.text:010036D2      push    _yBoxMac
.text:010036D8      mov     esi, eax
.text:010036DA      inc     esi
.text:010036DB      call   _Rnd@4          ; Rnd(x)
.text:010036E0      inc     eax
.text:010036E1      mov     ecx, eax
.text:010036E3      shl     ecx, 5          ; ECX=ECX*32
.text:010036E6      test   _rgBlk[ecx+esi], 80h
.text:010036EE      jnz    short loc_10036C7
.text:010036F0      shl     eax, 5          ; EAX=EAX*32
.text:010036F3      lea    eax, _rgBlk[eax+esi]
.text:010036FA      or     byte ptr [eax], 80h
.text:010036FD      dec    _cBombStart
.text:01003703      jnz    short loc_10036C7
```

Minesweeper allows you to set the board size, so the X (xBoxMac) and Y (yBoxMac) of the board are global variables. They are passed to Rnd() and random coordinates are generated. A mine is placed by the OR instruction at 0x010036FA. And if it has been placed before (it’s possible if the pair of Rnd() generates a coordinates pair which has been already generated), then TEST and JNZ at 0x010036E6 jumps to the generation routine again.

cBombStart is the global variable containing total number of mines. So this is loop.

The width of the array is 32 (we can conclude this by looking at the SHL instruction, which multiplies one of the coordinates by 32).

The size of the rgBlk global array can be easily determined by the difference between the rgBlk label in the data segment and the next known one. It is 0x360 (864):

```
.data:01005340 _rgBlk      db 360h dup(?)          ; DATA XREF: MainWndProc(x,x,x,x)+574
.data:01005340      ; DisplayBlk(x,x)+23
.data:010056A0 _Preferences dd ?                ; DATA XREF: FixMenus()+2
...
```

$864/32 = 27$ .

So the array size is  $27 * 32$ ? It is close to what we know: when we try to set board size to  $100 * 100$  in Minesweeper settings, it fallbacks to a board of size  $24 * 30$ . So this is the maximal board size here. And the array has a fixed size for any board size.

So let’s see all this in OllyDbg. We will ran Minesweeper, attaching OllyDbg to it and now we can see the memory dump at the address of the rgBlk array (0x01005340) <sup>5</sup>.

So we got this memory dump of the array:

```
Address  Hex dump
01005340  10 10 10 10|10 10 10 10|10 10 10 0F|0F 0F 0F 0F|
01005350  0F 0F 0F 0F|0F 0F 0F 0F|0F 0F 0F 0F|0F 0F 0F 0F|
01005360  10 0F 0F 0F|0F 0F 0F 0F|0F 0F 10 0F|0F 0F 0F 0F|
01005370  0F 0F 0F 0F|0F 0F 0F 0F|0F 0F 0F 0F|0F 0F 0F 0F|
01005380  10 0F 0F 0F|0F 0F 0F 0F|0F 0F 10 0F|0F 0F 0F 0F|
01005390  0F 0F 0F 0F|0F 0F 0F 0F|0F 0F 0F 0F|0F 0F 0F 0F|
```

<sup>5</sup>All addresses here are for Minesweeper for Windows XP SP3 English. They may differ for other service packs.



```

010053A0 10 0F 0F 0F|0F 0F 0F 0F|8F 0F 10 0F|0F 0F 0F 0F|
010053B0 0F 0F 0F 0F|0F 0F 0F 0F|0F 0F 0F 0F|0F 0F 0F 0F|
010053C0 10 0F 0F 0F|0F 0F 0F 0F|0F 0F 10 0F|0F 0F 0F 0F|
010053D0 0F 0F 0F 0F|0F 0F 0F 0F|0F 0F 0F 0F|0F 0F 0F 0F|
010053E0 10 0F 0F 0F|0F 0F 0F 0F|0F 0F 10 0F|0F 0F 0F 0F|
010053F0 0F 0F 0F 0F|0F 0F 0F 0F|0F 0F 0F 0F|0F 0F 0F 0F|
01005400 10 0F 0F 8F|0F 0F 8F 0F|0F 0F 10 0F|0F 0F 0F 0F|
01005410 0F 0F 0F 0F|0F 0F 0F 0F|0F 0F 0F 0F|0F 0F 0F 0F|
01005420 10 8F 0F 0F|8F 0F 0F 0F|0F 0F 10 0F|0F 0F 0F 0F|
01005430 0F 0F 0F 0F|0F 0F 0F 0F|0F 0F 0F 0F|0F 0F 0F 0F|
01005440 10 8F 0F 0F|0F 0F 8F 0F|0F 8F 10 0F|0F 0F 0F 0F|
01005450 0F 0F 0F 0F|0F 0F 0F 0F|0F 0F 0F 0F|0F 0F 0F 0F|
01005460 10 0F 0F 0F|0F 8F 0F 0F|0F 8F 10 0F|0F 0F 0F 0F|
01005470 0F 0F 0F 0F|0F 0F 0F 0F|0F 0F 0F 0F|0F 0F 0F 0F|
01005480 10 10 10 10|10 10 10 10|10 10 10 0F|0F 0F 0F 0F|
01005490 0F 0F 0F 0F|0F 0F 0F 0F|0F 0F 0F 0F|0F 0F 0F 0F|
010054A0 0F 0F 0F 0F|0F 0F 0F 0F|0F 0F 0F 0F|0F 0F 0F 0F|
010054B0 0F 0F 0F 0F|0F 0F 0F 0F|0F 0F 0F 0F|0F 0F 0F 0F|
010054C0 0F 0F 0F 0F|0F 0F 0F 0F|0F 0F 0F 0F|0F 0F 0F 0F|

```

OlllyDbg, like any other hexadecimal editor, shows 16 bytes per line. So each 32-byte array row occupies exactly 2 lines here.

This is beginner level (9\*9 board).

There is some square structure can be seen visually (0x10 bytes).

We will click “Run” in OlllyDbg to unfreeze the Minesweeper process, then we’ll clicked randomly at the Minesweeper window and trapped into mine, but now all mines are visible:



Figure 8.7: Mines

By comparing the mine places and the dump, we can conclude that 0x10 stands for border, 0x0F—empty block, 0x8F—mine. Perhaps, 0x10 is just a *sentinel value*.

Now we’ll add comments and also enclose all 0x8F bytes into square brackets:

```

border:
01005340 10 10 10 10 10 10 10 10 10 10 0F 0F 0F 0F
01005350 0F 0F 0F 0F 0F 0F 0F 0F 0F 0F 0F 0F 0F 0F
line #1:
01005360 10 0F 0F 0F 0F 0F 0F 0F 0F 10 0F 0F 0F 0F
01005370 0F 0F 0F 0F 0F 0F 0F 0F 0F 0F 0F 0F 0F 0F
line #2:
01005380 10 0F 0F 0F 0F 0F 0F 0F 0F 10 0F 0F 0F 0F
01005390 0F 0F 0F 0F 0F 0F 0F 0F 0F 0F 0F 0F 0F 0F
line #3:
010053A0 10 0F 0F 0F 0F 0F 0F 0F[8F]0F 10 0F 0F 0F 0F

```

```

010053B0 0F 0F 0F 0F 0F 0F 0F 0F 0F 0F 0F 0F 0F 0F 0F
line #4:
010053C0 10 0F 0F 0F 0F 0F 0F 0F 0F 0F 10 0F 0F 0F 0F
010053D0 0F 0F 0F 0F 0F 0F 0F 0F 0F 0F 0F 0F 0F 0F
line #5:
010053E0 10 0F 0F 0F 0F 0F 0F 0F 0F 0F 10 0F 0F 0F 0F
010053F0 0F 0F 0F 0F 0F 0F 0F 0F 0F 0F 0F 0F 0F 0F
line #6:
01005400 10 0F 0F[8F]0F 0F[8F]0F 0F 0F 10 0F 0F 0F 0F
01005410 0F 0F 0F 0F 0F 0F 0F 0F 0F 0F 0F 0F 0F 0F
line #7:
01005420 10[8F]0F 0F[8F]0F 0F 0F 0F 0F 10 0F 0F 0F 0F
01005430 0F 0F 0F 0F 0F 0F 0F 0F 0F 0F 0F 0F 0F 0F
line #8:
01005440 10[8F]0F 0F 0F 0F[8F]0F 0F[8F]10 0F 0F 0F 0F
01005450 0F 0F 0F 0F 0F 0F 0F 0F 0F 0F 0F 0F 0F 0F
line #9:
01005460 10 0F 0F 0F 0F[8F]0F 0F 0F[8F]10 0F 0F 0F 0F
01005470 0F 0F 0F 0F 0F 0F 0F 0F 0F 0F 0F 0F 0F 0F
border:
01005480 10 10 10 10 10 10 10 10 10 10 0F 0F 0F 0F
01005490 0F 0F 0F 0F 0F 0F 0F 0F 0F 0F 0F 0F 0F 0F

```

Now we'll remove all *border bytes* (0x10) and what's beyond those:

```

0F 0F 0F 0F 0F 0F 0F 0F
0F 0F 0F 0F 0F 0F 0F 0F
0F 0F 0F 0F 0F 0F[8F]0F
0F 0F 0F 0F 0F 0F 0F 0F
0F 0F 0F 0F 0F 0F 0F 0F
0F 0F[8F]0F 0F[8F]0F 0F 0F
[8F]0F 0F[8F]0F 0F 0F 0F 0F
[8F]0F 0F 0F 0F[8F]0F 0F[8F]
0F 0F 0F 0F[8F]0F 0F 0F[8F]

```

Yes, these are mines, now it can be clearly seen and compared with the screenshot.

What is interesting is that we can modify the array right in OllyDbg. We can remove all mines by changing all 0x8F bytes by 0x0F, and here is what we'll get in Minesweeper:

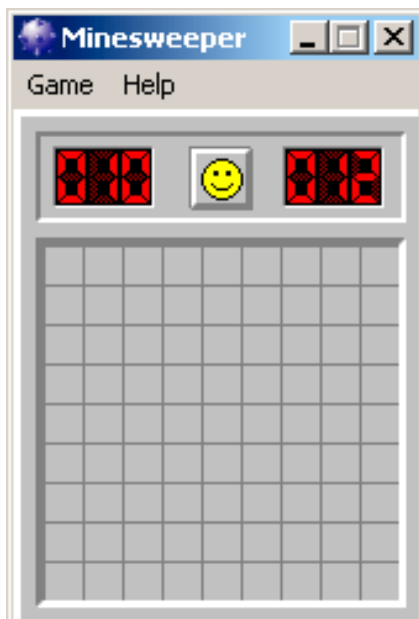

Figure 8.8: All mines are removed in debugger

We can also move all of them to the first line:

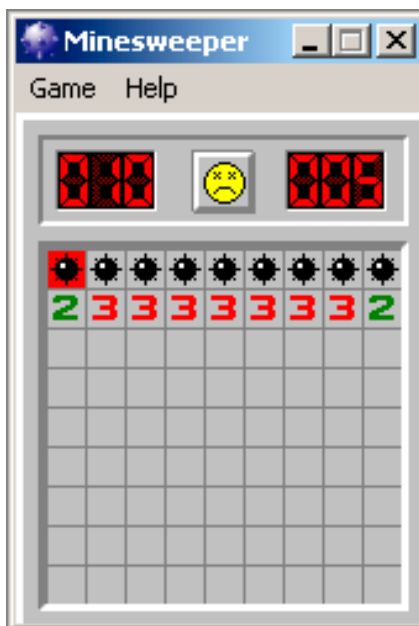

Figure 8.9: Mines set in debugger

Well, the debugger is not very convenient for eavesdropping (which is our goal anyway), so we'll write a small utility to dump the contents of the board:

```
// Windows XP MineSweeper cheater
// written by dennis(a)yurichev.com for http://beginners.re/ book
#include <windows.h>
#include <assert.h>
#include <stdio.h>

int main (int argc, char * argv[])
{
    int i, j;
    HANDLE h;
    DWORD PID, address, rd;
    BYTE board[27][32];
```

```

if (argc!=3)
{
    printf ("Usage: %s <PID> <address>\n", argv[0]);
    return 0;
};

assert (argv[1]!=NULL);
assert (argv[2]!=NULL);

assert (sscanf (argv[1], "%d", &PID)==1);
assert (sscanf (argv[2], "%x", &address)==1);

h=OpenProcess (PROCESS_VM_OPERATION | PROCESS_VM_READ | PROCESS_VM_WRITE, FALSE, PID);

if (h==NULL)
{
    DWORD e=GetLastError();
    printf ("OpenProcess error: %08X\n", e);
    return 0;
};

if (ReadProcessMemory (h, (LPVOID)address, board, sizeof(board), &rd)!=TRUE)
{
    printf ("ReadProcessMemory() failed\n");
    return 0;
};

for (i=1; i<26; i++)
{
    if (board[i][0]==0x10 && board[i][1]==0x10)
        break; // end of board
    for (j=1; j<31; j++)
    {
        if (board[i][j]==0x10)
            break; // board border
        if (board[i][j]==0x8F)
            printf ("*");
        else
            printf (" ");
    };
    printf ("\n");
};

CloseHandle (h);
};

```

Just set the [PID](#)<sup>6 7</sup> and the address of the array (0x01005340 for Windows XP SP3 English) and it will dump it<sup>8</sup>.

It attaches itself to a win32 process by [PID](#) and just reads process memory at the address.

### 8.4.1 Finding grid automatically

This is kind of nuisance to set address each time when we run our utility. Also, various Minesweeper versions may have the array on different address. Knowing the fact that there is always a border (0x10 bytes), we can just find it in memory:

```

// find frame to determine the address
process_mem=(BYTE*)malloc(process_mem_size);
assert (process_mem!=NULL);

if (ReadProcessMemory (h, (LPVOID)start_addr, process_mem, process_mem_size, &rd)!=TRUE)
{
    }

```

<sup>6</sup>Program/process ID

<sup>7</sup>PID it can be seen in Task Manager (enable it in "View → Select Columns")

<sup>8</sup>The compiled executable is here: [beginners.re](#)

```

        printf ("ReadProcessMemory() failed\n");
        return 0;
    };

    // for 9*9 grid.
    // FIXME: slow!
    for (i=0; i<process_mem_size; i++)
    {
        if (memcmp(process_mem+i, "\x10\x10\x10\x10\x10\x10\x10\x10\x10\x10\x0F\x0F\x
        ↵ \x0F\x0F\x0F\x0F\x0F\x0F\x0F\x0F\x0F\x0F\x0F\x0F\x0F\x0F\x0F\x0F\x0F\x0F\x0F\x0F\x10", 32) ↵
        ↵ ==0)
        {
            // found
            address=start_addr+i;
            break;
        };
    };
    if (address==0)
    {
        printf ("Can't determine address of frame (and grid)\n");
        return 0;
    }
    else
    {
        printf ("Found frame and grid at 0x%x\n", address);
    };
};

```

Full source code: [https://beginners.re/current-tree/examples/minesweeper/minesweeper\\_cheater2.c](https://beginners.re/current-tree/examples/minesweeper/minesweeper_cheater2.c).

### 8.4.2 Exercises

- Why do the *border bytes* (or *sentinel values*) (0x10) exist in the array? What they are for if they are not visible in Minesweeper's interface? How could it work without them?
- As it turns out, there are more values possible (for open blocks, for flagged by user, etc). Try to find the meaning of each one.
- Modify my utility so it can remove all mines or set them in a fixed pattern that you want in the Minesweeper process currently running.

## 8.5 Hacking Windows clock

Sometimes I do some kind of first April prank for my coworkers.

Let's find, if we could do something with Windows clock? Can we force to go clock hands backwards?

First of all, when you click on date/time in status bar, a `C:\WINDOWS\SYSTEM32\TIMEDATE.CPL` module gets executed, which is usual executable PE-file.

Let's see, how it draw hands? When I open the file (from Windows 7) in Resource Hacker, there are clock faces, but with no hands:

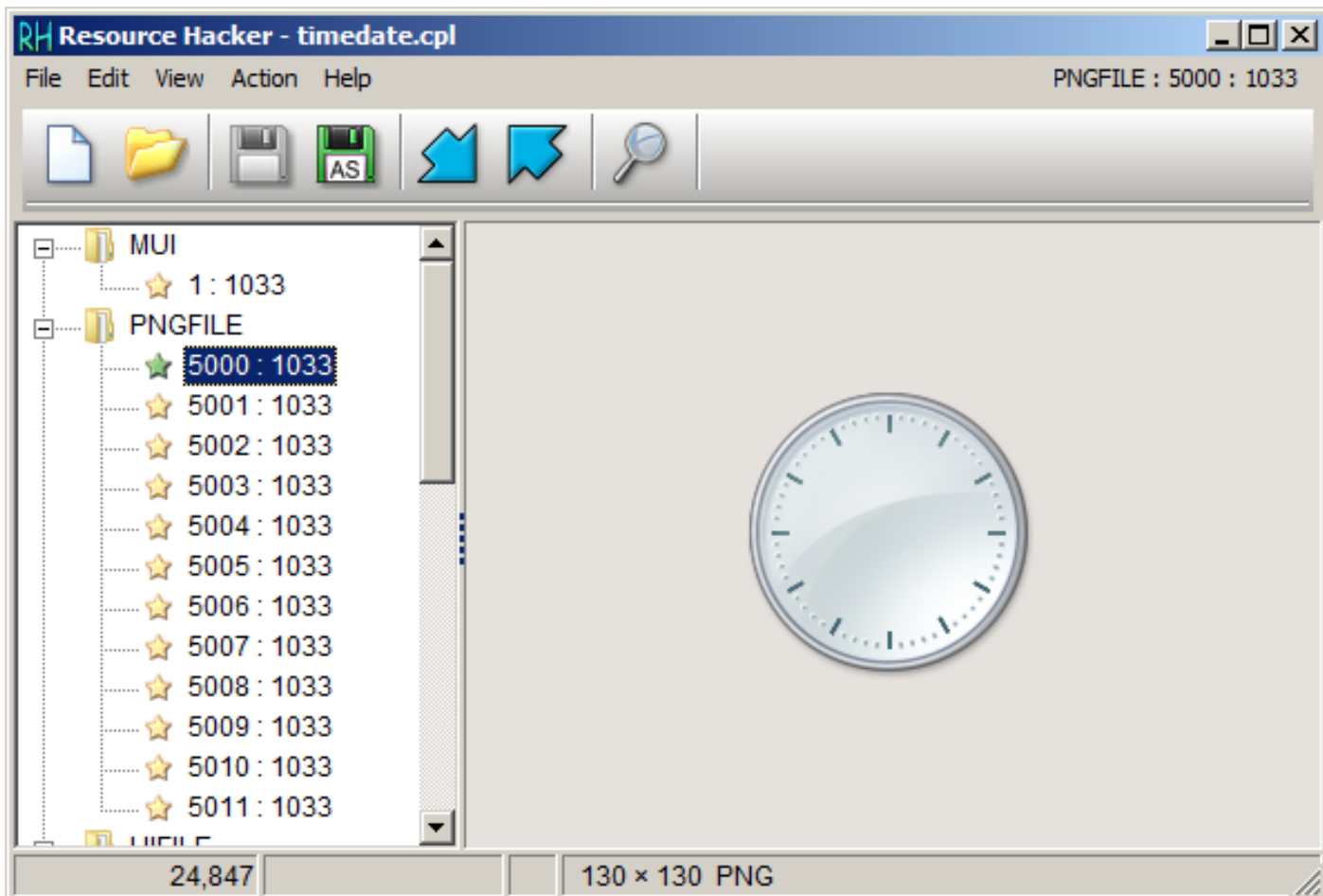

Figure 8.10: Resource Hacker

OK, what we know? How to draw a clock hand? All they are started at the middle of circle, ending with its border. Hence, we must calculate coordinates of a point on circle's border. From school-level mathematics we may recall that we have to use sine/cosine functions to draw circle, or at least square root. There are no such things in *TIMEDATE.CPL*, at least at first glance. But, thanks to Microsoft debugging PDB files, I can find a function named *CAnalogClock::DrawHand()*, which calls *Gdiplus::Graphics::DrawLine()* at least twice.

Here is its code:

```
.text:6EB9DBC7 ; private: enum Gdiplus::Status __thiscall CAnalogClock::_DrawHand(class
      Gdiplus::Graphics *, int, struct ClockHand const &, class Gdiplus::Pen *)
.text:6EB9DBC7 ?_DrawHand@CAnalogClock@@AAE?@
      ↪ AW4Status@Gdiplus@@PAVGraphics@3@HABUClockHand@@PAVPen@3@@Z proc near
.text:6EB9DBC7 ; CODE XREF: CAnalogClock::_ClockPaint(HDC__ *)+163
.text:6EB9DBC7 ; CAnalogClock::_ClockPaint(HDC__ *)+18B
.text:6EB9DBC7
.text:6EB9DBC7 var_10 = dword ptr -10h
.text:6EB9DBC7 var_C = dword ptr -0Ch
.text:6EB9DBC7 var_8 = dword ptr -8
.text:6EB9DBC7 var_4 = dword ptr -4
.text:6EB9DBC7 arg_0 = dword ptr 8
.text:6EB9DBC7 arg_4 = dword ptr 0Ch
.text:6EB9DBC7 arg_8 = dword ptr 10h
.text:6EB9DBC7 arg_C = dword ptr 14h
.text:6EB9DBC7
.text:6EB9DBC7 mov edi, edi
.text:6EB9DBC9 push ebp
.text:6EB9DBCA mov ebp, esp
.text:6EB9DBCC sub esp, 10h
.text:6EB9DBCF mov eax, [ebp+arg_4]
.text:6EB9DBD2 push ebx
.text:6EB9DBD3 push esi
.text:6EB9DBD4 push edi
```

```

.text:6EB9DBD5      cdq
.text:6EB9DBD6      push 3Ch
.text:6EB9DBD8      mov esi, ecx
.text:6EB9DBDA      pop ecx
.text:6EB9DBDB      idiv ecx
.text:6EB9DBDD      push 2
.text:6EB9DBDF      lea ebx, table[edx*8]
.text:6EB9DBE6      lea eax, [edx+1Eh]
.text:6EB9DBE9      cdq
.text:6EB9DBEA      idiv ecx
.text:6EB9DBEC      mov ecx, [ebp+arg_0]
.text:6EB9DBEF      mov [ebp+var_4], ebx
.text:6EB9DBF2      lea eax, table[edx*8]
.text:6EB9DBF9      mov [ebp+arg_4], eax
.text:6EB9DBFC      call ?SetInterpolationMode@Graphics@Gdiplus@@QAE?@
    ↪ AW4Status@2@W4InterpolationMode@2@@Z ;
    Gdiplus::Graphics::SetInterpolationMode(Gdiplus::InterpolationMode)
.text:6EB9DC01      mov eax, [esi+70h]
.text:6EB9DC04      mov edi, [ebp+arg_8]
.text:6EB9DC07      mov [ebp+var_10], eax
.text:6EB9DC0A      mov eax, [esi+74h]
.text:6EB9DC0D      mov [ebp+var_C], eax
.text:6EB9DC10      mov eax, [edi]
.text:6EB9DC12      sub eax, [edi+8]
.text:6EB9DC15      push 8000 ; nDenominator
.text:6EB9DC1A      push eax ; nNumerator
.text:6EB9DC1B      push dword ptr [ebx+4] ; nNumber
.text:6EB9DC1E      mov ebx, ds:__imp__MulDiv@12 ; MulDiv(x,x,x)
.text:6EB9DC24      call ebx ; MulDiv(x,x,x) ; MulDiv(x,x,x)
.text:6EB9DC26      add eax, [esi+74h]
.text:6EB9DC29      push 8000 ; nDenominator
.text:6EB9DC2E      mov [ebp+arg_8], eax
.text:6EB9DC31      mov eax, [edi]
.text:6EB9DC33      sub eax, [edi+8]
.text:6EB9DC36      push eax ; nNumerator
.text:6EB9DC37      mov eax, [ebp+var_4]
.text:6EB9DC3A      push dword ptr [eax] ; nNumber
.text:6EB9DC3C      call ebx ; MulDiv(x,x,x) ; MulDiv(x,x,x)
.text:6EB9DC3E      add eax, [esi+70h]
.text:6EB9DC41      mov ecx, [ebp+arg_0]
.text:6EB9DC44      mov [ebp+var_8], eax
.text:6EB9DC47      mov eax, [ebp+arg_8]
.text:6EB9DC4A      mov [ebp+var_4], eax
.text:6EB9DC4D      lea eax, [ebp+var_8]
.text:6EB9DC50      push eax
.text:6EB9DC51      lea eax, [ebp+var_10]
.text:6EB9DC54      push eax
.text:6EB9DC55      push [ebp+arg_C]
.text:6EB9DC58      call ?DrawLine@Graphics@Gdiplus@@QAE?@
    ↪ AW4Status@2@PBVPen@2@ABVPoint@2@1@Z ; Gdiplus::Graphics::DrawLine(Gdiplus::Pen const
    *,Gdiplus::Point const &,Gdiplus::Point const &)
.text:6EB9DC5D      mov ecx, [edi+8]
.text:6EB9DC60      test ecx, ecx
.text:6EB9DC62      jbe short loc_6EB9DCAA
.text:6EB9DC64      test eax, eax
.text:6EB9DC66      jnz short loc_6EB9DCAA
.text:6EB9DC68      mov eax, [ebp+arg_4]
.text:6EB9DC6B      push 8000 ; nDenominator
.text:6EB9DC70      push ecx ; nNumerator
.text:6EB9DC71      push dword ptr [eax+4] ; nNumber
.text:6EB9DC74      call ebx ; MulDiv(x,x,x) ; MulDiv(x,x,x)
.text:6EB9DC76      add eax, [esi+74h]
.text:6EB9DC79      push 8000 ; nDenominator
.text:6EB9DC7E      push dword ptr [edi+8] ; nNumerator
.text:6EB9DC81      mov [ebp+arg_8], eax
.text:6EB9DC84      mov eax, [ebp+arg_4]
.text:6EB9DC87      push dword ptr [eax] ; nNumber
.text:6EB9DC89      call ebx ; MulDiv(x,x,x) ; MulDiv(x,x,x)
.text:6EB9DC8B      add eax, [esi+70h]
.text:6EB9DC8E      mov ecx, [ebp+arg_0]

```

```

.text:6EB9DC91      mov     [ebp+var_8], eax
.text:6EB9DC94      mov     eax, [ebp+arg_8]
.text:6EB9DC97      mov     [ebp+var_4], eax
.text:6EB9DC9A      lea    eax, [ebp+var_8]
.text:6EB9DC9D      push   eax
.text:6EB9DC9E      lea    eax, [ebp+var_10]
.text:6EB9DCA1      push   eax
.text:6EB9DCA2      push   [ebp+arg_C]
.text:6EB9DCA5      call   ?DrawLine@Graphics@Gdiplus@@QAE?@
        ↪ AW4Status@2@PBVPen@2@ABVPoint@2@1@Z ; Gdiplus::Graphics::DrawLine(Gdiplus::Pen const
        *,Gdiplus::Point const &,Gdiplus::Point const &)
.text:6EB9DCAA
.text:6EB9DCAA  loc_6EB9DCAA:    ; CODE XREF: CAnalogClock::_DrawHand(Gdiplus::Graphics
        *,int,ClockHand const &,Gdiplus::Pen *)+9B
.text:6EB9DCAA      ; CAnalogClock::_DrawHand(Gdiplus::Graphics *,int,ClockHand const
        &,Gdiplus::Pen *)+9F
.text:6EB9DCAA      pop     edi
.text:6EB9DCAB      pop     esi
.text:6EB9DCAC      pop     ebx
.text:6EB9DCAD      leave
.text:6EB9DCAE      retn   10h
.text:6EB9DCAE  ?_DrawHand@CAnalogClock@@AAE?@
        ↪ AW4Status@Gdiplus@@PAVGraphics@3@HABUClockHand@@PAVPen@3@@@Z  endp
.text:6EB9DCAE

```

We can see that *DrawLine()* arguments are dependent on result of *MulDiv()* function and a *table[]* table (name is mine), which has 8-byte elements (look at LEA's second operand).

What is inside of *table[]*?

```

.text:6EB87890 ; int table[]
.text:6EB87890 table      dd 0
.text:6EB87894      dd 0FFFFFF0C1h
.text:6EB87898      dd 344h
.text:6EB8789C      dd 0FFFFFF0ECh
.text:6EB878A0      dd 67Fh
.text:6EB878A4      dd 0FFFFFF16Fh
.text:6EB878A8      dd 9A8h
.text:6EB878AC      dd 0FFFFFF248h
.text:6EB878B0      dd 0CB5h
.text:6EB878B4      dd 0FFFFFF374h
.text:6EB878B8      dd 0F9Fh
.text:6EB878BC      dd 0FFFFFF4F0h
.text:6EB878C0      dd 125Eh
.text:6EB878C4      dd 0FFFFFF6B8h
.text:6EB878C8      dd 14E9h
...

```

It's referenced only from *DrawHand()* function. It has 120 32-bit words or 60 32-bit pairs... wait, 60? Let's take a closer look at these values. First of all, I'll zap 6 pairs or 12 32-bit words with zeros, and then I'll put patched *TIMEDATE.CPL* into *C:\WINDOWS\SYSTEM32*. (You may need to set owner of the *\*TIMEDATE.CPL\** file to your primary user account (instead of *TrustedInstaller*), and also, boot in safe mode with command prompt so you can copy the file, which is usually locked.)



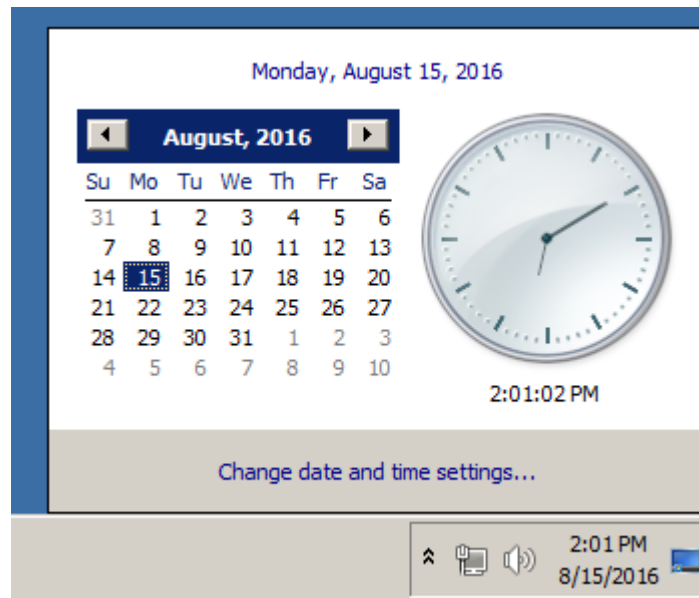

Figure 8.11: Attempt to run

Now when any hand is located at 0..5 seconds/minutes, it's invisible! However, opposite (shorter) part of second hand is visible and moving. When any hand is outside of this area, hand is visible as usual.

Let's take even closer look at the table in Mathematica. I have coppedasted table from the *TIMEDATE.CPL* to a *tbl* file (480 bytes). We will take for granted the fact that these are signed values, because half of elements are below zero (0FFFFE0C1h, etc.). If these values would be unsigned, they would be suspiciously huge.

```
In[]:= tbl = BinaryReadList["~/.../tbl", "Integer32"]

Out[]= {0, -7999, 836, -7956, 1663, -7825, 2472, -7608, 3253, -7308, 3999, \
-6928, 4702, -6472, 5353, -5945, 5945, -5353, 6472, -4702, 6928, \
-4000, 7308, -3253, 7608, -2472, 7825, -1663, 7956, -836, 8000, 0, \
7956, 836, 7825, 1663, 7608, 2472, 7308, 3253, 6928, 4000, 6472, \
4702, 5945, 5353, 5353, 5945, 4702, 6472, 3999, 6928, 3253, 7308, \
2472, 7608, 1663, 7825, 836, 7956, 0, 7999, -836, 7956, -1663, 7825, \
-2472, 7608, -3253, 7308, -4000, 6928, -4702, 6472, -5353, 5945, \
-5945, 5353, -6472, 4702, -6928, 3999, -7308, 3253, -7608, 2472, \
-7825, 1663, -7956, 836, -7999, 0, -7956, -836, -7825, -1663, -7608, \
-2472, -7308, -3253, -6928, -4000, -6472, -4702, -5945, -5353, -5353, \
-5945, -4702, -6472, -3999, -6928, -3253, -7308, -2472, -7608, -1663, \
-7825, -836, -7956}
```

```
In[]:= Length[tbl]
Out[]= 120
```

Let's treat two consecutive 32-bit values as pair:

```
In[]:= pairs = Partition[tbl, 2]
Out[]= {{0, -7999}, {836, -7956}, {1663, -7825}, {2472, -7608}, \
{3253, -7308}, {3999, -6928}, {4702, -6472}, {5353, -5945}, {5945, \
-5353}, {6472, -4702}, {6928, -4000}, {7308, -3253}, {7608, -2472}, \
{7825, -1663}, {7956, -836}, {8000, 0}, {7956, 836}, {7825, \
1663}, {7608, 2472}, {7308, 3253}, {6928, 4000}, {6472, \
4702}, {5945, 5353}, {5353, 5945}, {4702, 6472}, {3999, \
6928}, {3253, 7308}, {2472, 7608}, {1663, 7825}, {836, 7956}, {0, \
7999}, {-836, 7956}, {-1663, 7825}, {-2472, 7608}, {-3253, \
7308}, {-4000, 6928}, {-4702, 6472}, {-5353, 5945}, {-5945, \
5353}, {-6472, 4702}, {-6928, 3999}, {-7308, 3253}, {-7608, \
2472}, {-7825, 1663}, {-7956, 836}, {-7999, \
0}, {-7956, -836}, {-7825, -1663}, {-7608, -2472}, {-7308, -3253}, \
{-6928, -4000}, {-6472, -4702}, {-5945, -5353}, {-5353, -5945}, \
{-4702, -6472}, {-3999, -6928}, {-3253, -7308}, {-2472, -7608}, \
```

```
{-1663, -7825}, {-836, -7956}}
```

```
In[ ]:= Length[pairs]
```

```
Out[ ]= 60
```

Let's try to treat each pair as X/Y coordinate and draw all 60 pairs, and also first 15 pairs:

```
In[13]:= ListPlot[pairs, AspectRatio -> Full, ImageSize -> {300, 300}]
```

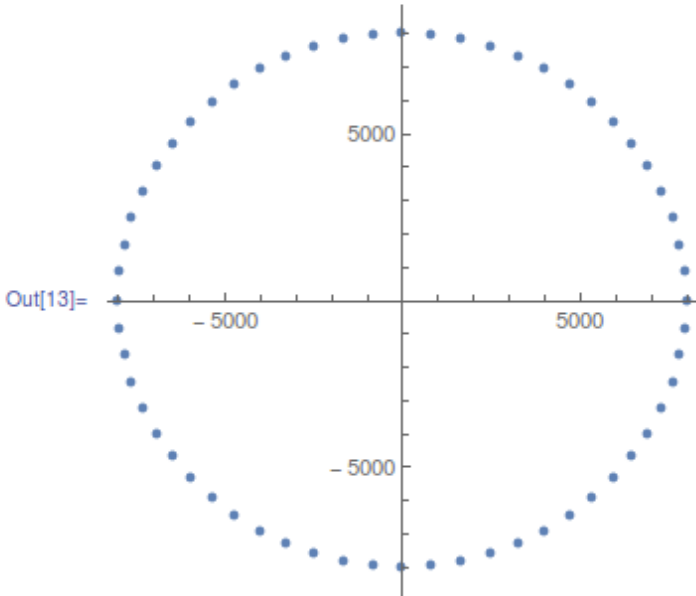

```
In[27]:= ListPlot[pairs[[1 ;; 15]], AspectRatio -> Full, ImageSize -> {300, 300}]
```

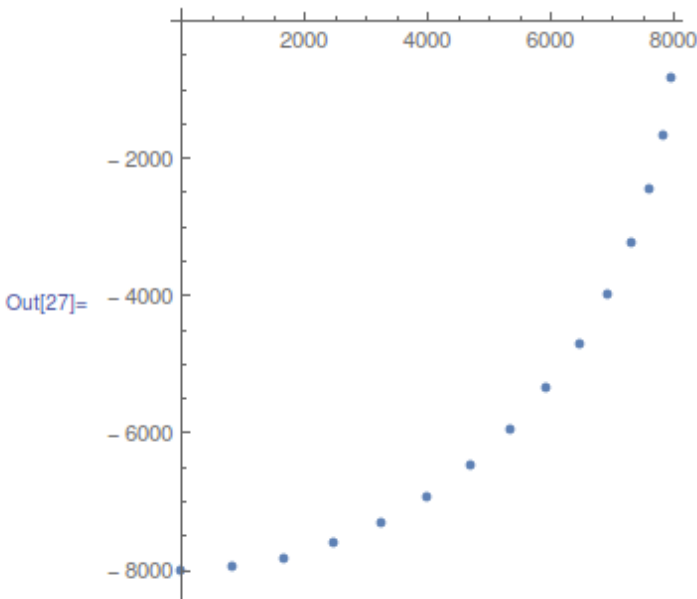

Figure 8.12: Mathematica

Now this is something! Each pair is just coordinate. First 15 pairs are coordinates for  $\frac{1}{4}$  of circle.

Perhaps, Microsoft developers precalculated all coordinates and put them into table. This is widespread, though somewhat old school practice - precalculated table access is faster than calling relatively slow sine/cosine functions<sup>9</sup>. Sine/cosine operations are not that expensive anymore...

Now I can understand why when I zapped first 6 pairs, hands were invisible at that area: in fact, hands were drawn, they just had zero length, because hand started at 0:0 coordinate and ended there.

<sup>9</sup>Today this is known as *memoization*

## The prank (practical joke)

Given all that, how would we force hands to go counterclockwise? In fact, this is simple, we need just to rotate the table, so each hand, instead of drawing at place of zeroth second, would be drawing at place of 59th second.

I made the patcher a long time ago, at the very beginning of 2000s, for Windows 2000. Hard to believe, it still works for Windows 7, perhaps, the table hasn't been changed since then!

The patcher source code: [https://beginners.re/current-tree/examples/timedate/time\\_pt.c](https://beginners.re/current-tree/examples/timedate/time_pt.c).

Now I can see all hands goes backwards:

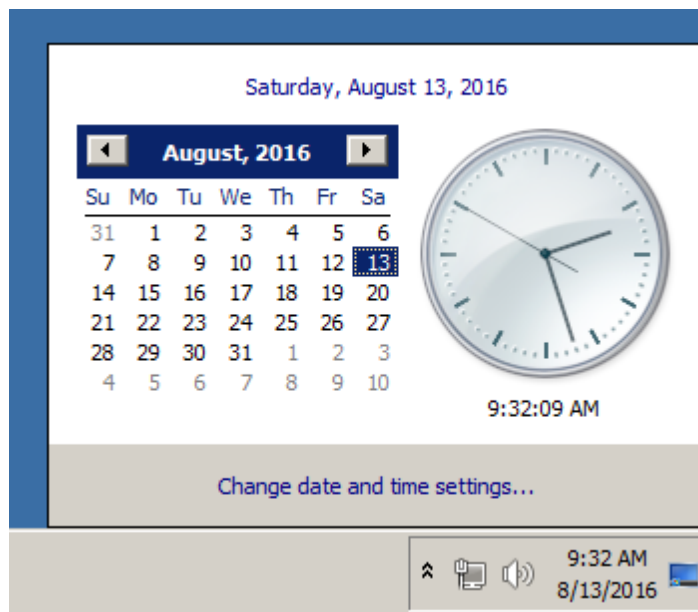

Figure 8.13: Now it works

Well, there is no animation in this book, but if you look closer, you can see, that hands are in fact shows correct time, but the whole clock face is rotated vertically, like we see it from the inside of clock.

## Windows 2000 leaked source code

So I did the patcher and then Windows 2000 source code has been leaked (I can't force you to trust me, though). Let's take a look on source code if that function and table.

The file is *win2k/private/shell/cpls/utc/clock.c*:

```
//  
// Array containing the sine and cosine values for hand positions.  
//  
POINT rCircleTable[] =  
{  
    { 0,      -7999},  
    { 836,   -7956},  
    { 1663,  -7825},  
    { 2472,  -7608},  
    { 3253,  -7308},  
    ...  
    { -4702, -6472},  
    { -3999, -6928},  
    { -3253, -7308},  
    { -2472, -7608},  
    { -1663, -7825},  
    { -836 , -7956},  
};  
  
////////////////////////////////////  
//  
// DrawHand
```

```

//
// Draws the hands of the clock.
//
////////////////////////////////////
void DrawHand(
    HDC hDC,
    int pos,
    HPEN hPen,
    int scale,
    int patMode,
    PLOCKSTR np)
{
    LPPPOINT lppt;
    int radius;

    MoveTo(hDC, np->clockCenter.x, np->clockCenter.y);
    radius = MulDiv(np->clockRadius, scale, 100);
    lppt = rCircleTable + pos;
    SetROP2(hDC, patMode);
    SelectObject(hDC, hPen);

    LineTo( hDC,
            np->clockCenter.x + MulDiv(lppt->x, radius, 8000),
            np->clockCenter.y + MulDiv(lppt->y, radius, 8000) );
}

```

Now it's clear: coordinates has been precalculated as if clock face has height and width of  $2 \cdot 8000$ , and then it's rescaled to current clock face radius using *MulDiv()* function.

POINT structure<sup>10</sup> is a structure of two 32-bit values, first is x, second is y.

## 8.6 (Windows 7) Solitaire: practical jokes

### 8.6.1 51 cards

This is a joke I did once for my coworkers who played a Solitaire game too much. I was wondering, if it's possible to remove some cards, or maybe add (duplicates).

I opened Solitaire.exe in IDA disassembler, which asked if to download PDB file for it from Microsoft servers. This is usually a rule for many Windows executables and DLLs. At least, PDB has all function names.

Then I tried to find a 52 number in all functions (because this card game uses 52 cards). As it turned out, only 2 functions has it.

The first is:

```

.text:00000001000393B4 ; __int64 __fastcall SolitaireGame::OnMoveComplete(SolitaireGame *this)
.text:00000001000393B4 ?OnMoveComplete@SolitaireGame@@QEAAHXZ proc near
...

```

The second is the function with self-describing name (name pulled from PDB by IDA): InitialDeal():

```

.text:00000001000365F8 ; void __fastcall SolitaireGame::InitialDeal(SolitaireGame *__hidden ↵
↵ this)
.text:00000001000365F8 ?InitialDeal@SolitaireGame@@QEAAXXZ proc near
.text:00000001000365F8
.text:00000001000365F8 var_58             = byte ptr -58h
.text:00000001000365F8 var_48             = qword ptr -48h
.text:00000001000365F8 var_40             = dword ptr -40h
.text:00000001000365F8 var_3C             = dword ptr -3Ch
.text:00000001000365F8 var_38             = dword ptr -38h
.text:00000001000365F8 var_30             = qword ptr -30h

```

<sup>10</sup>[https://msdn.microsoft.com/en-us/library/windows/desktop/dd162805\(v=vs.85\).aspx](https://msdn.microsoft.com/en-us/library/windows/desktop/dd162805(v=vs.85).aspx)

```

.text:00000001000365F8 var_28          = xmmword ptr -28h
.text:00000001000365F8 var_18          = byte ptr -18h
.text:00000001000365F8
.text:00000001000365F8 ; FUNCTION CHUNK AT .text:00000001000A55C2 SIZE 00000018 BYTES
.text:00000001000365F8
.text:00000001000365F8 ; __unwind { // __CxxFrameHandler3
.text:00000001000365F8          mov     rax, rsp
.text:00000001000365FB          push  rdi
.text:00000001000365FC          push  r12
.text:00000001000365FE          push  r13
.text:0000000100036600          sub   rsp, 60h
.text:0000000100036604          mov   [rsp+78h+var_48], 0FFFFFFFFFFFFFFEh
.text:000000010003660D          mov   [rax+8], rbx
.text:0000000100036611          mov   [rax+10h], rbp
.text:0000000100036615          mov   [rax+18h], rsi
.text:0000000100036619          movaps xmmword ptr [rax-28h], xmm6
.text:000000010003661D          mov   rsi, rcx
.text:0000000100036620          xor   edx, edx          ; struct Card *
.text:0000000100036622          call  ?
      ↪ SetSelectedCard@SolitaireGame@@QEAAAXPEAVCard@@@Z ; SolitaireGame::SetSelectedCard(Card *)
.text:0000000100036627          and   qword ptr [rsi+0F0h], 0
.text:000000010003662F          mov   rax, cs:??
      ↪ g_pSolitaireGame@@3PEAVSolitaireGame@@EA ; SolitaireGame * g_pSolitaireGame
.text:0000000100036636          mov   rdx, [rax+48h]
.text:000000010003663A          cmp   byte ptr [rdx+51h], 0
.text:000000010003663E          jz   short loc_10003664E
.text:0000000100036640          xor   r8d, r8d          ; bool
.text:0000000100036643          mov   dl, 1             ; int
.text:0000000100036645          lea  ecx, [r8+3]        ; this
.text:0000000100036649          call  ?PlaySoundProto@GameAudio@@YA_NH_NPEAI@Z ; ↪
      ↪ GameAudio::PlaySoundProto(int,bool,uint *)
.text:000000010003664E
.text:000000010003664E loc_10003664E:          ; CODE XREF: SolitaireGame::↪
      ↪ InitialDeal(void)+46
.text:000000010003664E          mov   rbx, [rsi+88h]
.text:0000000100036655          mov   r8d, 4
.text:000000010003665B          lea  rdx, aCardstackCreat ; "CardStack::CreateDeck()↪
      ↪ ::uiNumSuits == "...
.text:0000000100036662          mov   ebp, 10000h
.text:0000000100036667          mov   ecx, ebp          ; unsigned int
.text:0000000100036669          call  ?Log@@YAXIPEBGZZ ; Log(uint,ushort const *,...)
.text:000000010003666E          mov   r8d, 52          ; ---
.text:0000000100036674          lea  rdx, aCardstackCreat_0 ; "CardStack::CreateDeck↪
      ↪ ()::uiNumCards == "...
.text:000000010003667B          mov   ecx, ebp          ; unsigned int
.text:000000010003667D          call  ?Log@@YAXIPEBGZZ ; Log(uint,ushort const *,...)
.text:0000000100036682          xor   edi, edi

.text:0000000100036684 loc_100036684:          ; CODE XREF: SolitaireGame::↪
      ↪ InitialDeal(void)+C0
.text:0000000100036684          mov   eax, 4EC4EC4Fh
.text:0000000100036689          mul  edi
.text:000000010003668B          mov  r8d, edx
.text:000000010003668E          shr  r8d, 4             ; unsigned int
.text:0000000100036692          mov  eax, r8d
.text:0000000100036695          imul eax, 52           ; ---
.text:0000000100036698          mov  edx, edi
.text:000000010003669A          sub  edx, eax          ; unsigned int
.text:000000010003669C          mov  rcx, [rbx+128h] ; this
.text:00000001000366A3          call  ?CreateCard@CardTable@@IEAAPEAVCard@@II@Z ; ↪
      ↪ CardTable::CreateCard(uint,uint)
.text:00000001000366A8          mov  rdx, rax          ; struct Card *
.text:00000001000366AB          mov  rcx, rbx          ; this
.text:00000001000366AE          call  ?Push@CardStack@@QEAAAXPEAVCard@@@Z ; CardStack::↪
      ↪ Push(Card *)
.text:00000001000366B3          inc  edi
.text:00000001000366B5          cmp  edi, 52           ; ---
.text:00000001000366B8          jb   short loc_100036684

.text:00000001000366BA          xor  r8d, r8d          ; bool

```

```

.text:00000001000366BD      xor     edx, edx           ; bool
.text:00000001000366BF      mov     rcx, rbx           ; this
.text:00000001000366C2      call   ?Arrange@CardStack@@QEAAAX_N0@Z ; CardStack::A
    ↵ Arrange(bool,bool)
.text:00000001000366C7      mov     r13, [rsi+88h]
.text:00000001000366CE      lea    rdx, aCardstackShuff ; "CardStack::Shuffle()"
.text:00000001000366D5      mov     ecx, ebp           ; unsigned int
.text:00000001000366D7      call   ?Log@YAXIPEBGZZ ; Log(uint,ushort const *,...)
.text:00000001000366DC      and    [rsp+78h+var_40], 0
.text:00000001000366E1      and    [rsp+78h+var_3C], 0
.text:00000001000366E6      mov    [rsp+78h+var_38], 10h
.text:00000001000366EE      xor    ebx, ebx
.text:00000001000366F0      mov    [rsp+78h+var_30], rbx
...

```

Anyway, we clearly see a loop of 52 iterations. A loop body has calls to `CardTable()::CreateCard()` and `CardStack::Push()`.

The `CardTable::CreateCard()` eventually calls `Card::Init()` with values in 0..51 range, as one of its arguments. This can be easily checked using debugger.

So I tried just to change the 52 (0x34) number to 51 (0x33) in the `cmp edi, 52` instruction at 0x1000366B5 and run it. At first glance, nothing happened, but I noticed that now it's hard to solve the game. I spent almost an hour to reach this *position*:

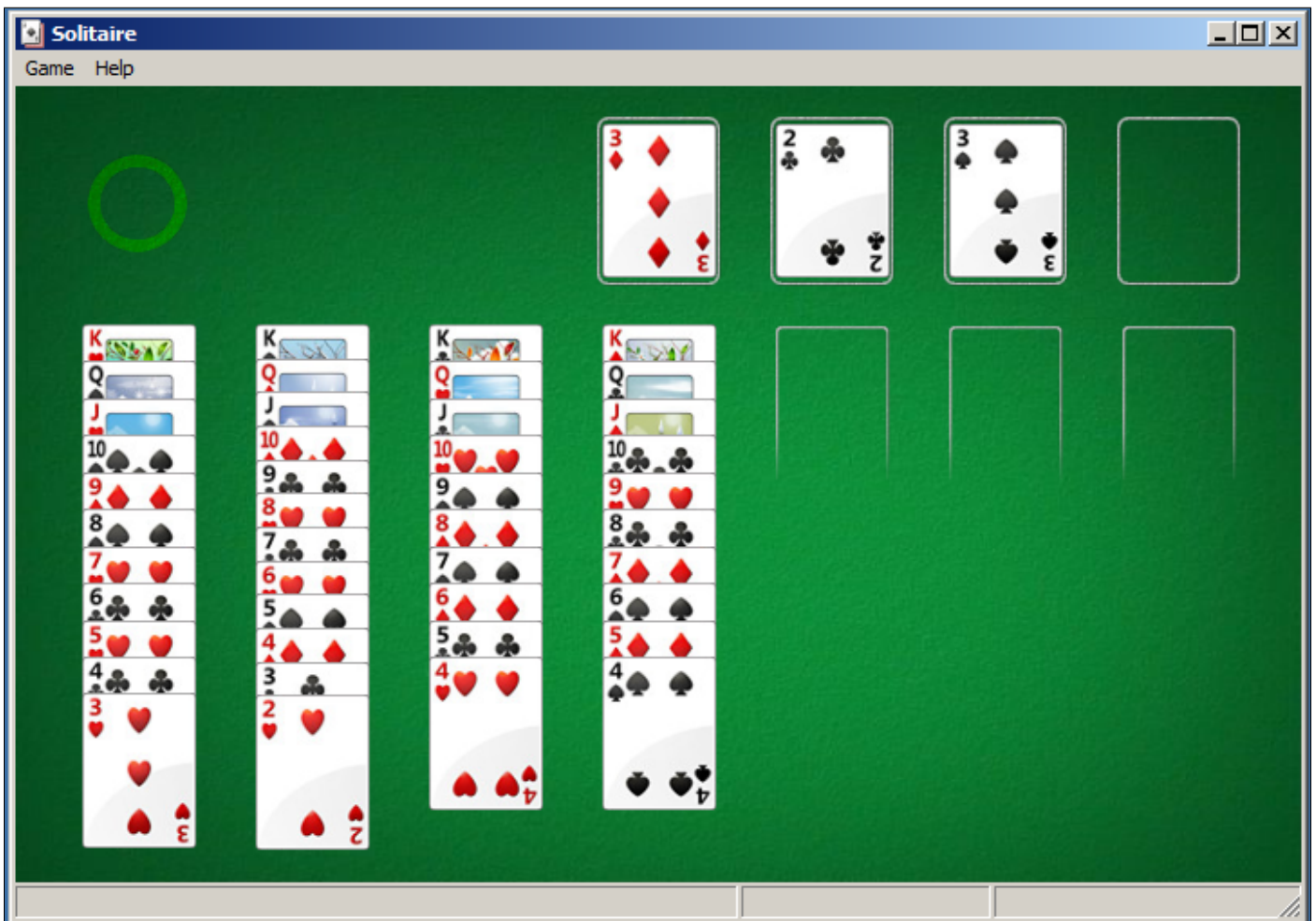

Ace of hearts is missing. Perhaps, internally, this card is numbered as 51th (if to number them from zero). In the other place I found all card names. Maybe names to be used to fetch card graphics from resources?

```

.data:00000001000B6970 ?CARD_NAME@Card@@2PAPEBGA dq offset aTwoofclubs
.data:00000001000B6970 ; "TwoOfClubs"
.data:00000001000B6978 dq offset aThreeofclubs ; "ThreeOfClubs"

```

```

.data:00000001000B6980      dq offset aFourofclubs ; "FourOfClubs"
.data:00000001000B6988      dq offset aFiveofclubs ; "FiveOfClubs"
.data:00000001000B6990      dq offset aSixofclubs ; "SixOfClubs"
.data:00000001000B6998      dq offset aSevenofclubs ; "SevenOfClubs"
.data:00000001000B69A0      dq offset aEightofclubs ; "EightOfClubs"
.data:00000001000B69A8      dq offset aNineofclubs ; "NineOfClubs"
.data:00000001000B69B0      dq offset aTenofclubs ; "TenOfClubs"
.data:00000001000B69B8      dq offset aJackofclubs ; "JackOfClubs"
.data:00000001000B69C0      dq offset aQueenofclubs ; "QueenOfClubs"
.data:00000001000B69C8      dq offset aKingofclubs ; "KingOfClubs"
.data:00000001000B69D0      dq offset aAceofclubs ; "AceOfClubs"
.data:00000001000B69D8      dq offset aTwoofdiamonds ; "TwoOfDiamonds"
.data:00000001000B69E0      dq offset aThreeofdiamond ; "ThreeOfDiamonds"
.data:00000001000B69E8      dq offset aFourofdiamonds ; "FourOfDiamonds"
.data:00000001000B69F0      dq offset aFiveofdiamonds ; "FiveOfDiamonds"
.data:00000001000B69F8      dq offset aSixofdiamonds ; "SixOfDiamonds"
.data:00000001000B6A00      dq offset aSevenofdiamond ; "SevenOfDiamonds"
.data:00000001000B6A08      dq offset aEightofdiamond ; "EightOfDiamonds"
.data:00000001000B6A10      dq offset aNineofdiamonds ; "NineOfDiamonds"
.data:00000001000B6A18      dq offset aTendofdiamonds ; "TenOfDiamonds"
.data:00000001000B6A20      dq offset aJackofdiamonds ; "JackOfDiamonds"
.data:00000001000B6A28      dq offset aQueenofdiamond ; "QueenOfDiamonds"
.data:00000001000B6A30      dq offset aKingofdiamonds ; "KingOfDiamonds"
.data:00000001000B6A38      dq offset aAceofdiamonds ; "AceOfDiamonds"
.data:00000001000B6A40      dq offset aTwoofspades ; "TwoOfSpades"
.data:00000001000B6A48      dq offset aThreeofspades ; "ThreeOfSpades"
.data:00000001000B6A50      dq offset aFourofspades ; "FourOfSpades"
.data:00000001000B6A58      dq offset aFiveofspades ; "FiveOfSpades"
.data:00000001000B6A60      dq offset aSixofspades ; "SixOfSpades"
.data:00000001000B6A68      dq offset aSevenofspades ; "SevenOfSpades"
.data:00000001000B6A70      dq offset aEightofspades ; "EightOfSpades"
.data:00000001000B6A78      dq offset aNineofspades ; "NineOfSpades"
.data:00000001000B6A80      dq offset aTenofspades ; "TenOfSpades"
.data:00000001000B6A88      dq offset aJackofspades ; "JackOfSpades"
.data:00000001000B6A90      dq offset aQueenofspades ; "QueenOfSpades"
.data:00000001000B6A98      dq offset aKingofspades ; "KingOfSpades"
.data:00000001000B6AA0      dq offset aAceofspades ; "AceOfSpades"
.data:00000001000B6AA8      dq offset aTwoofhearts ; "TwoOfHearts"
.data:00000001000B6AB0      dq offset aThreeofhearts ; "ThreeOfHearts"
.data:00000001000B6AB8      dq offset aFourofhearts ; "FourOfHearts"
.data:00000001000B6AC0      dq offset aFiveofhearts ; "FiveOfHearts"
.data:00000001000B6AC8      dq offset aSixofhearts ; "SixOfHearts"
.data:00000001000B6AD0      dq offset aSevenofhearts ; "SevenOfHearts"
.data:00000001000B6AD8      dq offset aEightofhearts ; "EightOfHearts"
.data:00000001000B6AE0      dq offset aNineofhearts ; "NineOfHearts"
.data:00000001000B6AE8      dq offset aTenofhearts ; "TenOfHearts"
.data:00000001000B6AF0      dq offset aJackofhearts ; "JackOfHearts"
.data:00000001000B6AF8      dq offset aQueenofhearts ; "QueenOfHearts"
.data:00000001000B6B00      dq offset aKingofhearts ; "KingOfHearts"
.data:00000001000B6B08      dq offset aAceofhearts ; "AceOfHearts"

.data:00000001000B6B10 ; public: static unsigned short const * near * Card::CARD_HUMAN_NAME
.data:00000001000B6B10 ?CARD_HUMAN_NAME@Card@@2PAPEBGA dq offset a54639Cardnames
.data:00000001000B6B10 ; "|54639|CardNames|Two Of Clubs"
    ↙
.data:00000001000B6B18      dq offset a64833Cardnames ; "|64833|CardNames|Three Of ↙
    ↙ Clubs"
.data:00000001000B6B20      dq offset a62984Cardnames ; "|62984|CardNames|Four Of ↙
    ↙ Clubs"
.data:00000001000B6B28      dq offset a65200Cardnames ; "|65200|CardNames|Five Of ↙
    ↙ Clubs"
.data:00000001000B6B30      dq offset a52967Cardnames ; "|52967|CardNames|Six Of ↙
    ↙ Clubs"
.data:00000001000B6B38      dq offset a42781Cardnames ; "|42781|CardNames|Seven Of ↙
    ↙ Clubs"
.data:00000001000B6B40      dq offset a49217Cardnames ; "|49217|CardNames|Eight Of ↙
    ↙ Clubs"
.data:00000001000B6B48      dq offset a44682Cardnames ; "|44682|CardNames|Nine Of ↙
    ↙ Clubs"
.data:00000001000B6B50      dq offset a51853Cardnames ; "|51853|CardNames|Ten Of ↙

```

↳ Clubs"	
.data:00000001000B6B58	dq offset a46368Cardnames ; " 46368 CardNames Jack Of ↵
↳ Clubs"	
.data:00000001000B6B60	dq offset a61344Cardnames ; " 61344 CardNames Queen Of ↵
↳ Clubs"	
.data:00000001000B6B68	dq offset a65017Cardnames ; " 65017 CardNames King Of ↵
↳ Clubs"	
.data:00000001000B6B70	dq offset a57807Cardnames ; " 57807 CardNames Ace Of ↵
↳ Clubs"	
.data:00000001000B6B78	dq offset a48455Cardnames ; " 48455 CardNames Two Of ↵
↳ Diamonds"	
.data:00000001000B6B80	dq offset a44156Cardnames ; " 44156 CardNames Three Of ↵
↳ Diamonds"	
.data:00000001000B6B88	dq offset a51672Cardnames ; " 51672 CardNames Four Of ↵
↳ Diamonds"	
.data:00000001000B6B90	dq offset a45972Cardnames ; " 45972 CardNames Five Of ↵
↳ Diamonds"	
.data:00000001000B6B98	dq offset a47206Cardnames ; " 47206 CardNames Six Of ↵
↳ Diamonds"	
.data:00000001000B6BA0	dq offset a48399Cardnames ; " 48399 CardNames Seven Of ↵
↳ Diamonds"	
.data:00000001000B6BA8	dq offset a47847Cardnames ; " 47847 CardNames Eight Of ↵
↳ Diamonds"	
.data:00000001000B6BB0	dq offset a48606Cardnames ; " 48606 CardNames Nine Of ↵
↳ Diamonds"	
.data:00000001000B6BB8	dq offset a61278Cardnames ; " 61278 CardNames Ten Of ↵
↳ Diamonds"	
.data:00000001000B6BC0	dq offset a52038Cardnames ; " 52038 CardNames Jack Of ↵
↳ Diamonds"	
.data:00000001000B6BC8	dq offset a54643Cardnames ; " 54643 CardNames Queen Of ↵
↳ Diamonds"	
.data:00000001000B6BD0	dq offset a48902Cardnames ; " 48902 CardNames King Of ↵
↳ Diamonds"	
.data:00000001000B6BD8	dq offset a46672Cardnames ; " 46672 CardNames Ace Of ↵
↳ Diamonds"	
.data:00000001000B6BE0	dq offset a41049Cardnames ; " 41049 CardNames Two Of ↵
↳ Spades"	
.data:00000001000B6BE8	dq offset a49327Cardnames ; " 49327 CardNames Three Of ↵
↳ Spades"	
.data:00000001000B6BF0	dq offset a51933Cardnames ; " 51933 CardNames Four Of ↵
↳ Spades"	
.data:00000001000B6BF8	dq offset a42651Cardnames ; " 42651 CardNames Five Of ↵
↳ Spades"	
.data:00000001000B6C00	dq offset a65342Cardnames ; " 65342 CardNames Six Of ↵
↳ Spades"	
.data:00000001000B6C08	dq offset a53644Cardnames ; " 53644 CardNames Seven Of ↵
↳ Spades"	
.data:00000001000B6C10	dq offset a54466Cardnames ; " 54466 CardNames Eight Of ↵
↳ Spades"	
.data:00000001000B6C18	dq offset a56874Cardnames ; " 56874 CardNames Nine Of ↵
↳ Spades"	
.data:00000001000B6C20	dq offset a46756Cardnames ; " 46756 CardNames Ten Of ↵
↳ Spades"	
.data:00000001000B6C28	dq offset a62876Cardnames ; " 62876 CardNames Jack Of ↵
↳ Spades"	
.data:00000001000B6C30	dq offset a64633Cardnames ; " 64633 CardNames Queen Of ↵
↳ Spades"	
.data:00000001000B6C38	dq offset a46215Cardnames ; " 46215 CardNames King Of ↵
↳ Spades"	
.data:00000001000B6C40	dq offset a60450Cardnames ; " 60450 CardNames Ace Of ↵
↳ Spades"	
.data:00000001000B6C48	dq offset a51010Cardnames ; " 51010 CardNames Two Of ↵
↳ Hearts"	
.data:00000001000B6C50	dq offset a64948Cardnames ; " 64948 CardNames Three Of ↵
↳ Hearts"	
.data:00000001000B6C58	dq offset a43079Cardnames ; " 43079 CardNames Four Of ↵
↳ Hearts"	
.data:00000001000B6C60	dq offset a57131Cardnames ; " 57131 CardNames Five Of ↵
↳ Hearts"	
.data:00000001000B6C68	dq offset a58953Cardnames ; " 58953 CardNames Six Of ↵



```

    ↪ Hearts"
.data:00000001000B6C70          dq offset a45105Cardnames ; "|45105|CardNames|Seven Of ↵
    ↪ Hearts"
.data:00000001000B6C78          dq offset a47775Cardnames ; "|47775|CardNames|Eight Of ↵
    ↪ Hearts"
.data:00000001000B6C80          dq offset a41825Cardnames ; "|41825|CardNames|Nine Of ↵
    ↪ Hearts"
.data:00000001000B6C88          dq offset a41501Cardnames ; "|41501|CardNames|Ten Of ↵
    ↪ Hearts"
.data:00000001000B6C90          dq offset a47108Cardnames ; "|47108|CardNames|Jack Of ↵
    ↪ Hearts"
.data:00000001000B6C98          dq offset a55659Cardnames ; "|55659|CardNames|Queen Of ↵
    ↪ Hearts"
.data:00000001000B6CA0          dq offset a44572Cardnames ; "|44572|CardNames|King Of ↵
    ↪ Hearts"
.data:00000001000B6CA8          dq offset a44183Cardnames ; "|44183|CardNames|Ace Of ↵
    ↪ Hearts"

```

If you want to do this to someone, be sure his/her mental health is stable.

Aside of function names from PDB file, there are lots of Log() function calls that can help significantly, because the Solitaire game reports about what it's doing right now.

Homework: try to *remove* several cards or two of clubs. And what if to swap card names in arrays of strings?

I also tried to pass a numbers like 0, 0..50 to Card:Init() (so to have 2 zeroes in a list of 52 numbers). Then I saw two *two of clubs* cards at one moment, but Solitaire behaves erratically.

This is patched Windows 7 Solitare: [Solitaire51.exe](#).

## 8.6.2 53 cards

Now take a look on the first part of the loop:

```

.text:0000000100036684 loc_100036684:          ; CODE XREF: SolitaireGame::↵
    ↪ InitialDeal(void)+↵C0j
.text:0000000100036684          mov     eax, 4EC4EC4Fh
.text:0000000100036689          mul     edi
.text:000000010003668B          mov     r8d, edx
.text:000000010003668E          shr     r8d, 4          ; unsigned int
.text:0000000100036692          mov     eax, r8d
.text:0000000100036695          imul   eax, 52
.text:0000000100036698          mov     edx, edi
.text:000000010003669A          sub     edx, eax          ; unsigned int
.text:000000010003669C          mov     rcx, [rbx+128h] ; this
.text:00000001000366A3          call   ?CreateCard@CardTable@@IEAAPEAVCard@@II@Z ; ↵
    ↪ CardTable::CreateCard(uint,uint)
.text:00000001000366A8          mov     rdx, rax          ; struct Card *
.text:00000001000366AB          mov     rcx, rbx          ; this
.text:00000001000366AE          call   ?Push@CardStack@@QEAAPEAVCard@@@Z ; CardStack::↵
    ↪ Push(Card *)
.text:00000001000366B3          inc     edi
.text:00000001000366B5          cmp     edi, 52
.text:00000001000366B8          jnb    short loc_100036684

```

What is with multiplication by 4EC4EC4Fh? Surely, this is division by multiplication. And what Hex-Rays can say:

```

v5 = 0;
do
{
    v6 = CardTable::CreateCard(v4[37], v5 % 0x34, v5 / 0x34);
    CardStack::Push((CardStack *)v4, v6);
    ++v5;
}
while ( v5 < 0x34 );

```

Somehow, CreateCard() function takes two arguments: iterator divided by 52 and a remainder of the division operation. Hard to say, why they did so. Solitaire can't allow more than 52 cards, so the last argument is senseless, it's always zero.

But when I patch cmp edi, 52 instruction at 0x1000366B5 to be cmp edi, 53, I found that there are now 53 cards. The last one is *two of clubs*, because it's numbered as 0th card.

During the last iteration, 0x52 is divided by 0x52, remainder is zero, so 0th card is added twice.

What a frustration, there are two *two of clubs*:



This is patched Windows 7 Solitaire: [Solitaire53](#).

## 8.7 FreeCell prank (Windows 7)

This is a prank I once played for my coworkers who played FreeCell solitaire too much. Can we make FreeCell always deal the same game each time? Like, you know, in "Groundhog Day" movie?

(I'm writing this in November 2019. Somehow, IDA can't get PDBs from Microsoft servers. Maybe Windows 7 is unsupported anymore? Anyway, I can't get function names...)

### 8.7.1 Part I

So I loaded FreeCell.exe into IDA and found that both rand(), srand() and time() are imported from msvcrt.dll. time() is indeed used as a seed for srand():

```
.text:01029612          sub_1029612    proc near          ; CODE XREF:
                    sub_102615C+149
.text:01029612          ; sub_1029DA6+67
.text:01029612 8B FF          mov     edi, edi
```

```

.text:01029614 56          push    esi
.text:01029615 57          push    edi
.text:01029616 6A 00      push    0          ; Time
.text:01029618 8B F9      mov     edi, ecx
.text:0102961A FF 15 80 16 00+  call   ds:time
.text:01029620 50          push    eax          ; Seed
.text:01029621 FF 15 84 16 00+  call   ds:srand
.text:01029627 8B 35 AC 16 00+  mov     esi, ds:rand
.text:0102962D 59          pop     ecx
.text:0102962E 59          pop     ecx
.text:0102962F FF D6      call   esi ; rand
.text:01029631 FF D6      call   esi ; rand
.text:01029633
.text:01029633          loc_1029633:          ; CODE XREF:
                    sub_1029612+26
.text:01029633          ; sub_1029612+2D
.text:01029633 FF D6      call   esi ; rand
.text:01029635 83 F8 01    cmp     eax, 1
.text:01029638 7C F9      jl     short loc_1029633
.text:0102963A 3D 40 42 0F 00  cmp     eax, 1000000
.text:0102963F 7F F2      jg     short loc_1029633
.text:01029641 6A 01      push   1
.text:01029643 50          push   eax
.text:01029644 8B CF      mov     ecx, edi
.text:01029646 E8 2D F8 FF FF  call   sub_1028E78
.text:0102964B 5F          pop     edi
.text:0102964C 5E          pop     esi
.text:0102964D C3          retn
.text:0102964D          sub_1029612          endp

```

Several (redundant) calls to rand() are funny, that reminds me:

“In the morning you will send for a hansom, desiring your man to take neither the first nor the second which may present itself.” ( The Memoirs of Sherlock Holmes, by Arthur Conan Doyle<sup>11</sup> )

There is another call of time() and srand() pair, but my [tracer](#) showed that this is the point of our interest:

```

tracer.exe -l:FreeCell.exe bpf=msvcrt.dll!time bpf=msvcrt.dll!srand,args:1

...

TID=5340|(0) msvcrt.dll!time() (called from FreeCell.exe!BASE+0x29620 (0x209620))
TID=5340|(0) msvcrt.dll!time() -> 0x5ddb68aa
TID=5340|(1) msvcrt.dll!srand(0x5ddb68aa) (called from FreeCell.exe!BASE+0x29627 (0x209627))
TID=5340|(1) msvcrt.dll!srand() -> 0x5507e0
TID=5340|(1) msvcrt.dll!srand(0x399f) (called from FreeCell.exe!BASE+0x27d3a (0x207d3a))
TID=5340|(1) msvcrt.dll!srand() -> 0x5507e0

```

You see, the time() function returned 0x5ddb68aa and the very same value is used as an argument for srand().

Let's try to force time() to always return 0:

```

tracer.exe -l:FreeCell.exe bpf=msvcrt.dll!time,rt:0 bpf=msvcrt.dll!srand,args:1

...

TID=2104|(0) msvcrt.dll!time() (called from FreeCell.exe!BASE+0x29620 (0xb19620))
TID=2104|(0) msvcrt.dll!time() -> 0x5ddb68f6
TID=2104|(0) Modifying EAX register to 0x0
TID=2104|(1) msvcrt.dll!srand(0x0) (called from FreeCell.exe!BASE+0x29627 (0xb19627))
TID=2104|(1) msvcrt.dll!srand() -> 0x3707e0
TID=2104|(1) msvcrt.dll!srand(0x52f6) (called from FreeCell.exe!BASE+0x27d3a (0xb17d3a))
TID=2104|(1) msvcrt.dll!srand() -> 0x3707e0

```

<sup>11</sup><http://www.gutenberg.org/files/834/834-0.txt>

Now I'm seeing the same game each time I'm running FreeCell using [tracer](#):

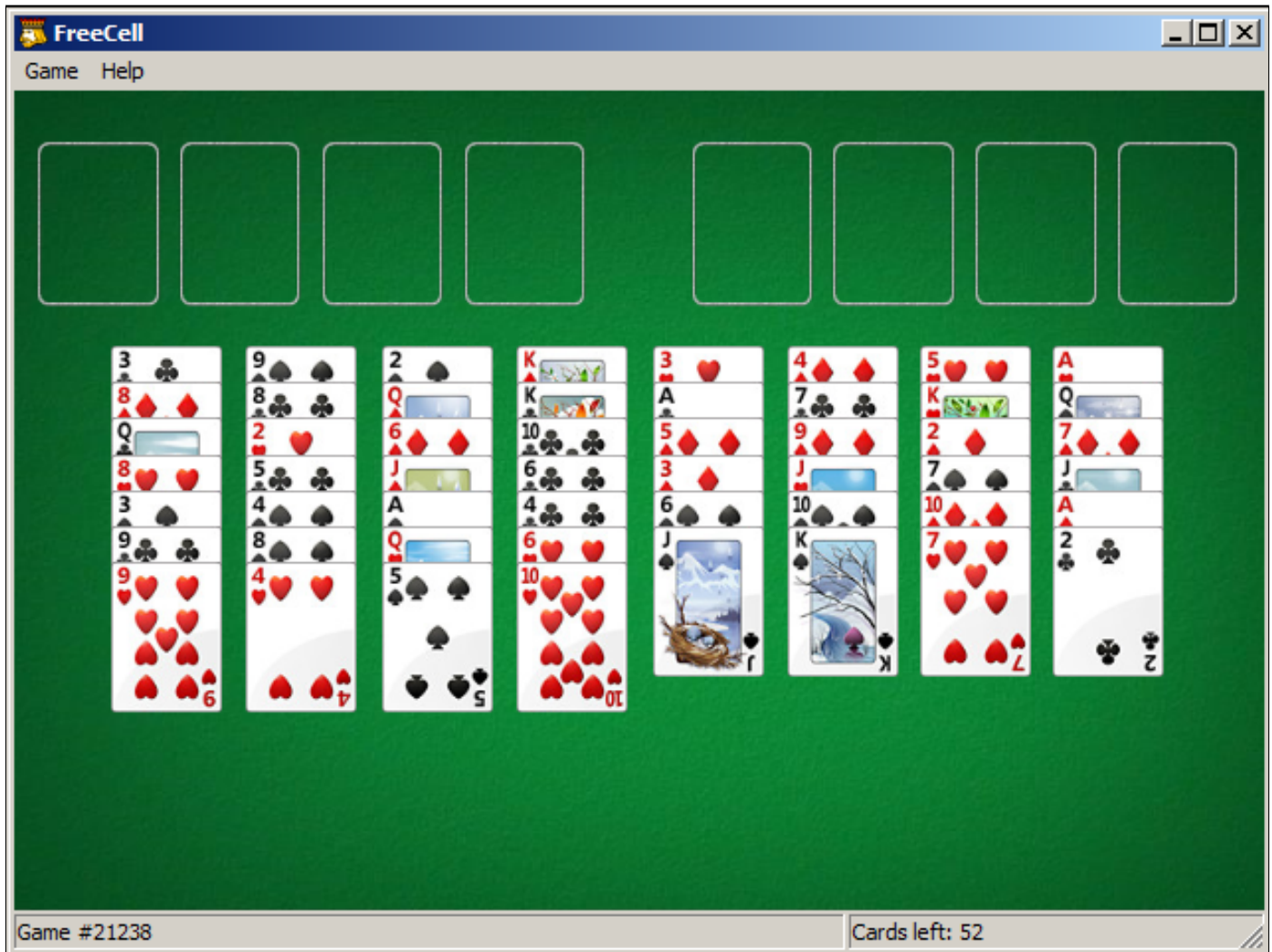

Now how to patch the executable?

We want to pass 0 as an argument to `srand()` at `0x01029620`. But there is a one-byte instruction: `PUSH EAX`. `PUSH 0` is two-byte instruction. How to squeeze it into?

What is in other registers at this moment? Using [tracer](#) I'm dumping all them:

```
tracer.exe -l:FreeCell.exe bpx=FreeCell.exe!0x01029620

...

TID=4448|(0) FreeCell.exe!0x1029620
EAX=0x5ddb6ac4 EBX=0x00000000 ECX=0x00000000 EDX=0x00000000
ESI=0x054732d0 EDI=0x054732d0 EBP=0x0020f2bc ESP=0x0020f298
EIP=0x00899620
FLAGS=PF ZF IF
TID=4448|(0) FreeCell.exe!0x1029620
EAX=0x5ddb6ac8 EBX=0x00000002 ECX=0x00000000 EDX=0x00000000
ESI=0xffffffff EDI=0x054732d0 EBP=0x0020da78 ESP=0x0020d9d4
EIP=0x00899620
FLAGS=PF ZF IF
TID=4448|(0) FreeCell.exe!0x1029620
EAX=0x5ddb6aca EBX=0x00000002 ECX=0x00000000 EDX=0x00000000
ESI=0x7740c460 EDI=0x054732d0 EBP=0x0020da78 ESP=0x0020d9d4
EIP=0x00899620
FLAGS=PF ZF IF

...
```

No matter how often I restart the game, ECX and EDX are seems to be always 0. So I patching PUSH EAX at 0x01029620 to PUSH EDX (also one-byte instruction), and now FreeCell always shows the same game to the player.

However, other options could exist. As a matter of fact, we don't need to pass 0 to srand(). Rather, we want to pass a *constant* to srand() to make game the same each time. As we can see, EDI's value hasn't been changing. Maybe we could try it as well.

Now a bit harder patching. Let's open FreeCell.exe in Hiew:

```

Hiew: FreeCell.exe
C:\tmp\FreeCell.exe
.01029612: 8BFF      mov     edi,edi
.01029614: 56       push   esi
.01029615: 57       push   edi
.01029616: 6A00    push   0
.01029618: 8BF9    mov     edi,ecx
.0102961A: FF1580160001 call   time
.01029620: 50       push   eax
.01029621: FF1584160001 call   srand
.01029627: 8B35AC160001 mov     esi,rand --[1]
.0102962D: 59       pop    ecx
.0102962E: 59       pop    ecx
.0102962F: FFD6    call   esi
.01029631: FFD6    call   esi
.01029633: FFD6    2call  esi

```

We have no space to replace one-byte PUSH EAX with two-byte PUSH 0. And we can't simply fill CALL ds:time with NOPS, because there is a FIXUP (address of time() function in msvcrt.dll). (Hiew marked these 4 bytes are gray bytes.) So what I'm doing: patching first 2 bytes to EB 04. This is a JMP to bypass 4 FIXUP-ed bytes:

```

Hiew: FreeCell.exe
C:\tmp\FreeCell.exe
.01029612: 8BFF      mov     edi,edi
.01029614: 56       push   esi
.01029615: 57       push   edi
.01029616: 6A00    push   0
.01029618: 8BF9    mov     edi,ecx
.0102961A: EB04    jmps   .001029620 --[1]
.0102961C: 801600  adc    b,[esi],0
.0102961F: 0190FF158416 add    [eax][0168415FF],edx
.01029625: 0001    add    [ecx],al
.01029627: 8B35AC160001 mov     esi,rand --[2]
.0102962D: 59       pop    ecx
.0102962E: 90       nop
.0102962F: FFD6    call   esi
.01029631: FFD6    call   esi
.01029633: FFD6    call   esi

```

Then I replace PUSH EAX with NOP. So that srand() would have its zeroes arguments from PUSH 0 above. Also, I patch one of POP ECX to NOP, because I removed one PUSH.

```

Hiew: FreeCell.exe
C:\tmp\FreeCell.exe
.01029620: 90          nop
.01029621: FF1584160001 call      srand
.01029627: 8B35AC160001 mov      esi,rand --1
.0102962D: 59          pop      ecx
.0102962E: 90          nop
.0102962F: FFD6       call     esi
.01029631: FFD6       call     esi
.01029633: FFD6       call     esi
.01029635: 83F801     cmp     eax,1

```

Now Windows loader will write 4-byte FIXUP at 0x0102961C, but we don't care: time()'s address will not be used anymore.

### 8.7.2 Part II: breaking the *Select Game* submenu

The user can still choose different game in the menu. Let's see if srand() is still called. I'm trying to enter 1/2/3 in "Select Game" dialog box:

```

tracer.exe -l:FreeCell.exe bpf=msvcrt.dll!srand,args:1
...
TID=4936|(0) msvcrt.dll!srand(0x5ddb6df9) (called from FreeCell.exe!BASE+0x29627 (0xb49627))
TID=4936|(0) msvcrt.dll!srand() -> 0x5907e0
TID=4936|(0) msvcrt.dll!srand(0x2b40) (called from FreeCell.exe!BASE+0x27d3a (0xb47d3a))
TID=4936|(0) msvcrt.dll!srand() -> 0x5907e0
TID=4936|(0) msvcrt.dll!srand(0x1) (called from FreeCell.exe!BASE+0x27d3a (0xb47d3a))
TID=4936|(0) msvcrt.dll!srand() -> 0x5907e0
TID=4936|(0) msvcrt.dll!srand(0x2) (called from FreeCell.exe!BASE+0x27d3a (0xb47d3a))
TID=4936|(0) msvcrt.dll!srand() -> 0x5907e0
TID=4936|(0) msvcrt.dll!srand(0x3) (called from FreeCell.exe!BASE+0x27d3a (0xb47d3a))
TID=4936|(0) msvcrt.dll!srand() -> 0x5907e0

```

Yes, the number user enters is just an argument for srand(). Where it is called?

```

.text:01027CBA          loc_1027CBA:                                ; CODE XREF: sub\_1027AC6
        ↓ +179
.text:01027CBA 83 FF FC          cmp     edi, 0FFFFFFFh
.text:01027CBD 75 74            jnz     short loc_1027D33
...
.text:01027D33          loc_1027D33:                                ; CODE XREF: sub\_1027AC6
        ↓ +1F7
.text:01027D33 57              push    edi                                ; Seed
.text:01027D34 FF 15 84 16 00+  call   ds:srand
.text:01027D3A 59              pop     ecx
.text:01027D3B 6A 34           push    34h
.text:01027D3D 5B              pop     ebx
.text:01027D3E 33 C0           xor     eax, eax

```

I couldn't patch one-byte PUSH EDI to two-byte PUSH 0. But I see that there is only one single jump to loc\_1027D33 from the above.

I'm patching CMP EDI, ... to XOR EDI, EDI, padding the 3rd byte to NOP. I'm patching also JNZ to JMP, so that jump will always occur.

Now FreeCell ignores the number user enters, but suddenly, there is also the same game at start:

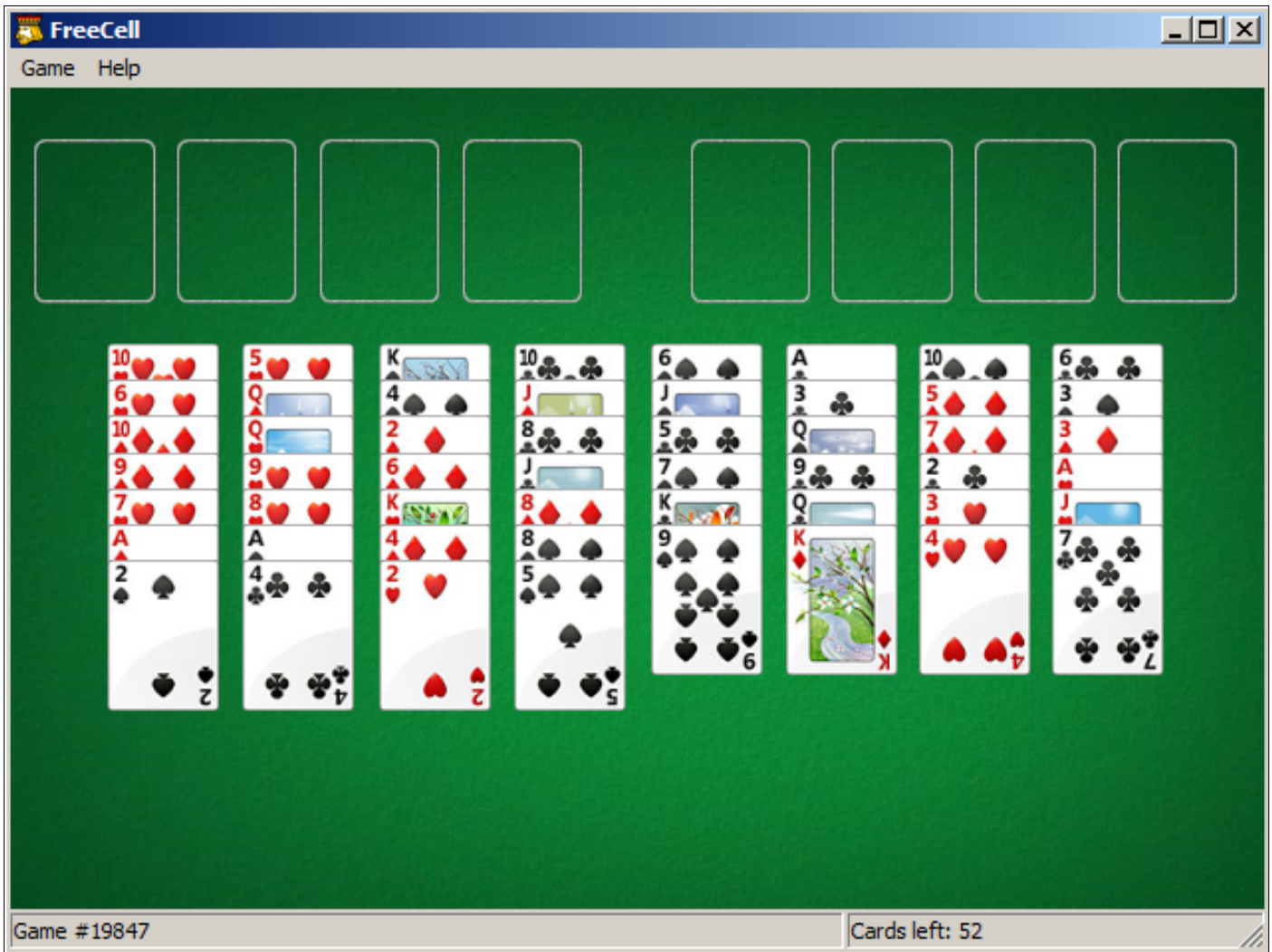

It seems that the code we patched in part I is somehow connected to a code after 0x01027CBD, that executes if  $EDI == 0xFFFFFFFFC$ . Anyway, our goal is accomplished — the game is always the same at the start and the user can't choose another using the menu.

## 8.8 Dongles

The author of these lines, occasionally did software copy-protection [dongle](#) replacements, or “dongle emulators” and here are couple examples of how it's happening.

About one of the cases about Rocket and Z3 that is not present here, you can read here: [http://yurichev.com/tmp/SAT\\_SMT\\_DRAFT.pdf](http://yurichev.com/tmp/SAT_SMT_DRAFT.pdf).

### 8.8.1 Example #1: MacOS Classic and PowerPC

Here is an example of a program for MacOS Classic <sup>12</sup>, for PowerPC. The company who developed the software product has disappeared a long time ago, so the (legal) customer was afraid of physical dongle damage.

While running without a dongle connected, a message box with the text “Invalid Security Device” appeared.

Luckily, this text string could easily be found in the executable binary file.

Let's pretend we are not very familiar both with Mac OS Classic and PowerPC, but will try anyway.

IDA opened the executable file smoothly, reported its type as “PEF (Mac OS or Be OS executable)” (indeed, it is a standard Mac OS Classic file format).

By searching for the text string with the error message, we've got into this code fragment:

<sup>12</sup>pre-UNIX MacOS

```

...
seg000:000C87FC 38 60 00 01  li    %r3, 1
seg000:000C8800 48 03 93 41  bl    check1
seg000:000C8804 60 00 00 00  nop
seg000:000C8808 54 60 06 3F  clrlwi. %r0, %r3, 24
seg000:000C880C 40 82 00 40  bne   OK
seg000:000C8810 80 62 9F D8  lwz   %r3, TC_aInvalidSecurityDevice
...

```

Yes, this is PowerPC code.

The CPU is a very typical 32-bit [RISC](#) of 1990s era.

Each instruction occupies 4 bytes (just as in MIPS and ARM) and the names somewhat resemble MIPS instruction names.

check1() is a function name we'll give to it later. BL is *Branch Link* instruction, e.g., intended for calling subroutines.

The crucial point is the [BNE](#) instruction which jumps if the dongle protection check passes or not if an error occurs: then the address of the text string gets loaded into the r3 register for the subsequent passing into a message box routine.

From the [Steve Zucker, SunSoft and Kari Karhi, IBM, *SYSTEM V APPLICATION BINARY INTERFACE: PowerPC Processor Supplement*, (1995)]<sup>13</sup> we will find out that the r3 register is used for return values (and r4, in case of 64-bit values).

Another yet unknown instruction is CLRLWI. From [*PowerPC(tm) Microprocessor Family: The Programming Environments for 32-Bit Microprocessors*, (2000)]<sup>14</sup> we'll learn that this instruction does both clearing and loading. In our case, it clears the 24 high bits from the value in r3 and puts them in r0, so it is analogical to MOVZX in x86 ( [1.23.1 on page 202](#)), but it also sets the flags, so [BNE](#) can check them afterwards.

Let's take a look into the check1() function:

```

seg000:00101B40          check1: # CODE XREF: seg000:00063E7Cp
seg000:00101B40          # sub_64070+160p ...
seg000:00101B40          .set arg_8, 8
seg000:00101B40          mflr   %r0
seg000:00101B44 7C 08 02 A6          stw    %r0, arg_8(%sp)
seg000:00101B48 94 21 FF C0          stwu   %sp, -0x40(%sp)
seg000:00101B4C 48 01 6B 39          bl     check2
seg000:00101B50 60 00 00 00          nop
seg000:00101B54 80 01 00 48          lwz    %r0, 0x40+arg_8(%sp)
seg000:00101B58 38 21 00 40          addi   %sp, %sp, 0x40
seg000:00101B5C 7C 08 03 A6          mtlr   %r0
seg000:00101B60 4E 80 00 20          blr
seg000:00101B60          # End of function check1

```

As you can see in [IDA](#), that function is called from many places in the program, but only the r3 register's value is checked after each call.

All this function does is to call the other function, so it is a [thunk function](#): there are function prologue and epilogue, but the r3 register is not touched, so check1() returns what check2() returns.

[BLR](#)<sup>15</sup> looks like the return from the function, but since [IDA](#) does the function layout, we probably do not need to care about this.

Since it is a typical [RISC](#), it seems that subroutines are called using a [link register](#), just like in ARM.

The check2() function is more complex:

```

seg000:00118684          check2: # CODE XREF: check1+Cp
seg000:00118684          .set var_18, -0x18

```

<sup>13</sup>Also available as [http://yurichev.com/mirrors/PowerPC/elfspec\\_ppc.pdf](http://yurichev.com/mirrors/PowerPC/elfspec_ppc.pdf)

<sup>14</sup>Also available as [http://yurichev.com/mirrors/PowerPC/6xx\\_pem.pdf](http://yurichev.com/mirrors/PowerPC/6xx_pem.pdf)

<sup>15</sup>(PowerPC) Branch to Link Register



```

seg000:00118684      .set var_C, -0xC
seg000:00118684      .set var_8, -8
seg000:00118684      .set var_4, -4
seg000:00118684      .set arg_8, 8
seg000:00118684  93 E1 FF FC    stw    %r31, var_4(%sp)
seg000:00118688  7C 08 02 A6    mflr  %r0
seg000:0011868C  83 E2 95 A8    lwz    %r31, off_1485E8 # dword_24B704
seg000:00118690      .using dword_24B704, %r31
seg000:00118690  93 C1 FF F8    stw    %r30, var_8(%sp)
seg000:00118694  93 A1 FF F4    stw    %r29, var_C(%sp)
seg000:00118698  7C 7D 1B 78    mr     %r29, %r3
seg000:0011869C  90 01 00 08    stw    %r0, arg_8(%sp)
seg000:001186A0  54 60 06 3E    clrlwi %r0, %r3, 24
seg000:001186A4  28 00 00 01    cmplwi %r0, 1
seg000:001186A8  94 21 FF B0    stwu   %sp, -0x50(%sp)
seg000:001186AC  40 82 00 0C    bne   loc_1186B8
seg000:001186B0  38 60 00 01    li    %r3, 1
seg000:001186B4  48 00 00 6C    b     exit
seg000:001186B8      loc_1186B8: # CODE XREF: check2+28j
seg000:001186B8  48 00 03 D5    bl    sub_118A8C
seg000:001186BC  60 00 00 00    nop
seg000:001186C0  3B C0 00 00    li    %r30, 0
seg000:001186C4      skip:      # CODE XREF: check2+94j
seg000:001186C4  57 C0 06 3F    clrlwi. %r0, %r30, 24
seg000:001186C8  41 82 00 18    beq   loc_1186E0
seg000:001186CC  38 61 00 38    addi  %r3, %sp, 0x50+var_18
seg000:001186D0  80 9F 00 00    lwz   %r4, dword_24B704
seg000:001186D4  48 00 C0 55    bl    .RBEFINDNEXT
seg000:001186D8  60 00 00 00    nop
seg000:001186DC  48 00 00 1C    b     loc_1186F8
seg000:001186E0      loc_1186E0: # CODE XREF: check2+44j
seg000:001186E0  80 BF 00 00    lwz   %r5, dword_24B704
seg000:001186E4  38 81 00 38    addi  %r4, %sp, 0x50+var_18
seg000:001186E8  38 60 08 C2    li    %r3, 0x1234
seg000:001186EC  48 00 BF 99    bl    .RBEFINDFIRST
seg000:001186F0  60 00 00 00    nop
seg000:001186F4  3B C0 00 01    li    %r30, 1
seg000:001186F8      loc_1186F8: # CODE XREF: check2+58j
seg000:001186F8  54 60 04 3F    clrlwi. %r0, %r3, 16
seg000:001186FC  41 82 00 0C    beq   must_jump
seg000:00118700  38 60 00 00    li    %r3, 0      # error
seg000:00118704  48 00 00 1C    b     exit
seg000:00118708      must_jump: # CODE XREF: check2+78j
seg000:00118708  7F A3 EB 78    mr     %r3, %r29
seg000:0011870C  48 00 00 31    bl    check3
seg000:00118710  60 00 00 00    nop
seg000:00118714  54 60 06 3F    clrlwi. %r0, %r3, 24
seg000:00118718  41 82 FF AC    beq   skip
seg000:0011871C  38 60 00 01    li    %r3, 1
seg000:00118720      exit:     # CODE XREF: check2+30j
seg000:00118720      # check2+80j
seg000:00118720  80 01 00 58    lwz   %r0, 0x50+arg_8(%sp)
seg000:00118724  38 21 00 50    addi  %sp, %sp, 0x50
seg000:00118728  83 E1 FF FC    lwz   %r31, var_4(%sp)
seg000:0011872C  7C 08 03 A6    mtlr  %r0
seg000:00118730  83 C1 FF F8    lwz   %r30, var_8(%sp)
seg000:00118734  83 A1 FF F4    lwz   %r29, var_C(%sp)
seg000:00118738  4E 80 00 20    blr
seg000:00118738      # End of function check2

```

We are lucky again: some function names are left in the executable (debug symbols section? Hard to say while we are not very familiar with the file format, maybe it is some kind of PE exports?

(6.5.2)),

like `.RBEFINDNEXT()` and `.RBEFINDFIRST()`.

Eventually these functions call other functions with names like `.GetNextDeviceViaUSB()`, `.USBSendPKT()`, so these are clearly dealing with an USB device.

There is even a function named `.GetNextEve3Device()`—sounds familiar, there was a Sentinel Eve3 dongle for ADB port (present on Macs) in 1990s.

Let's first take a look on how the `r3` register is set before return, while ignoring everything else.

We know that a “good” `r3` value has to be non-zero, zero `r3` leads the execution flow to the message box with an error message.

There are two `li %r3, 1` instructions present in the function and one `li %r3, 0` (*Load Immediate*, i.e., loading a value into a register). The first instruction is at `0x001186B0`—and frankly speaking, it's hard to say what it means.

What we see next is, however, easier to understand: `.RBEFINDFIRST()` is called: if it fails, 0 is written into `r3` and we jump to `exit`, otherwise another function is called (`check3()`)—if it fails too, `.RBEFINDNEXT()` is called, probably in order to look for another USB device.

N.B.: `clrlwi. %r0, %r3, 16` it is analogical to what we already saw, but it clears 16 bits, i.e., `.RBEFINDFIRST()` probably returns a 16-bit value.

`B` (stands for *branch*) unconditional jump.

`BEQ` is the inverse instruction of `BNE`.

Let's see `check3()`:

```
seg000:0011873C          check3: # CODE XREF: check2+88p
seg000:0011873C
seg000:0011873C          .set var_18, -0x18
seg000:0011873C          .set var_C, -0xC
seg000:0011873C          .set var_8, -8
seg000:0011873C          .set var_4, -4
seg000:0011873C          .set arg_8, 8
seg000:0011873C
seg000:0011873C 93 E1 FF FC   stw    %r31, var_4(%sp)
seg000:00118740 7C 08 02 A6   mflr  %r0
seg000:00118744 38 A0 00 00   li    %r5, 0
seg000:00118748 93 C1 FF F8   stw    %r30, var_8(%sp)
seg000:0011874C 83 C2 95 A8   lwz    %r30, off_1485E8 # dword_24B704
seg000:00118750          .using dword_24B704, %r30
seg000:00118750 93 A1 FF F4   stw    %r29, var_C(%sp)
seg000:00118754 3B A3 00 00   addi   %r29, %r3, 0
seg000:00118758 38 60 00 00   li    %r3, 0
seg000:0011875C 90 01 00 08   stw    %r0, arg_8(%sp)
seg000:00118760 94 21 FF B0   stwu   %sp, -0x50(%sp)
seg000:00118764 80 DE 00 00   lwz    %r6, dword_24B704
seg000:00118768 38 81 00 38   addi   %r4, %sp, 0x50+var_18
seg000:0011876C 48 00 C0 5D   bl    .RBEREAD
seg000:00118770 60 00 00 00   nop
seg000:00118774 54 60 04 3F   clrlwi. %r0, %r3, 16
seg000:00118778 41 82 00 0C   beq    loc_118784
seg000:0011877C 38 60 00 00   li    %r3, 0
seg000:00118780 48 00 02 F0   b     exit
seg000:00118784
seg000:00118784          loc_118784: # CODE XREF: check3+3Cj
seg000:00118784 A0 01 00 38   lhz    %r0, 0x50+var_18(%sp)
seg000:00118788 28 00 04 B2   cmplwi %r0, 0x1100
seg000:0011878C 41 82 00 0C   beq    loc_118798
seg000:00118790 38 60 00 00   li    %r3, 0
seg000:00118794 48 00 02 DC   b     exit
seg000:00118798
seg000:00118798          loc_118798: # CODE XREF: check3+50j
seg000:00118798 80 DE 00 00   lwz    %r6, dword_24B704
seg000:0011879C 38 81 00 38   addi   %r4, %sp, 0x50+var_18
seg000:001187A0 38 60 00 01   li    %r3, 1
seg000:001187A4 38 A0 00 00   li    %r5, 0
seg000:001187A8 48 00 C0 21   bl    .RBEREAD
seg000:001187AC 60 00 00 00   nop
```

```

seg000:001187B0 54 60 04 3F  clrlwi. %r0, %r3, 16
seg000:001187B4 41 82 00 0C  beq     loc_1187C0
seg000:001187B8 38 60 00 00  li     %r3, 0
seg000:001187BC 48 00 02 B4  b      exit
seg000:001187C0
seg000:001187C0          loc_1187C0: # CODE XREF: check3+78j
seg000:001187C0 A0 01 00 38  lhz    %r0, 0x50+var_18(%sp)
seg000:001187C4 28 00 06 4B  cmplwi %r0, 0x09AB
seg000:001187C8 41 82 00 0C  beq    loc_1187D4
seg000:001187CC 38 60 00 00  li    %r3, 0
seg000:001187D0 48 00 02 A0  b      exit
seg000:001187D4
seg000:001187D4          loc_1187D4: # CODE XREF: check3+8Cj
seg000:001187D4 4B F9 F3 D9  bl     sub_B7BAC
seg000:001187D8 60 00 00 00  nop
seg000:001187DC 54 60 06 3E  clrlwi %r0, %r3, 24
seg000:001187E0 2C 00 00 05  cmpwi  %r0, 5
seg000:001187E4 41 82 01 00  beq    loc_1188E4
seg000:001187E8 40 80 00 10  bge    loc_1187F8
seg000:001187EC 2C 00 00 04  cmpwi  %r0, 4
seg000:001187F0 40 80 00 58  bge    loc_118848
seg000:001187F4 48 00 01 8C  b      loc_118980
seg000:001187F8
seg000:001187F8          loc_1187F8: # CODE XREF: check3+ACj
seg000:001187F8 2C 00 00 0B  cmpwi  %r0, 0xB
seg000:001187FC 41 82 00 08  beq    loc_118804
seg000:00118800 48 00 01 80  b      loc_118980
seg000:00118804
seg000:00118804          loc_118804: # CODE XREF: check3+C0j
seg000:00118804 80 DE 00 00  lwz    %r6, dword_24B704
seg000:00118808 38 81 00 38  addi   %r4, %sp, 0x50+var_18
seg000:0011880C 38 60 00 08  li    %r3, 8
seg000:00118810 38 A0 00 00  li    %r5, 0
seg000:00118814 48 00 BF B5  bl     .RBEREAD
seg000:00118818 60 00 00 00  nop
seg000:0011881C 54 60 04 3F  clrlwi. %r0, %r3, 16
seg000:00118820 41 82 00 0C  beq    loc_11882C
seg000:00118824 38 60 00 00  li    %r3, 0
seg000:00118828 48 00 02 48  b      exit
seg000:0011882C
seg000:0011882C          loc_11882C: # CODE XREF: check3+E4j
seg000:0011882C A0 01 00 38  lhz    %r0, 0x50+var_18(%sp)
seg000:00118830 28 00 11 30  cmplwi %r0, 0xFEAO
seg000:00118834 41 82 00 0C  beq    loc_118840
seg000:00118838 38 60 00 00  li    %r3, 0
seg000:0011883C 48 00 02 34  b      exit
seg000:00118840
seg000:00118840          loc_118840: # CODE XREF: check3+F8j
seg000:00118840 38 60 00 01  li    %r3, 1
seg000:00118844 48 00 02 2C  b      exit
seg000:00118848
seg000:00118848          loc_118848: # CODE XREF: check3+B4j
seg000:00118848 80 DE 00 00  lwz    %r6, dword_24B704
seg000:0011884C 38 81 00 38  addi   %r4, %sp, 0x50+var_18
seg000:00118850 38 60 00 0A  li    %r3, 0xA
seg000:00118854 38 A0 00 00  li    %r5, 0
seg000:00118858 48 00 BF 71  bl     .RBEREAD
seg000:0011885C 60 00 00 00  nop
seg000:00118860 54 60 04 3F  clrlwi. %r0, %r3, 16
seg000:00118864 41 82 00 0C  beq    loc_118870
seg000:00118868 38 60 00 00  li    %r3, 0
seg000:0011886C 48 00 02 04  b      exit
seg000:00118870
seg000:00118870          loc_118870: # CODE XREF: check3+128j
seg000:00118870 A0 01 00 38  lhz    %r0, 0x50+var_18(%sp)
seg000:00118874 28 00 03 F3  cmplwi %r0, 0xA6E1
seg000:00118878 41 82 00 0C  beq    loc_118884
seg000:0011887C 38 60 00 00  li    %r3, 0
seg000:00118880 48 00 01 F0  b      exit
seg000:00118884

```

```

seg000:00118884          loc_118884: # CODE XREF: check3+13Cj
seg000:00118884 57 BF 06 3E  clrlwi  %r31, %r29, 24
seg000:00118888 28 1F 00 02  cmplwi  %r31, 2
seg000:0011888C 40 82 00 0C  bne     loc_118898
seg000:00118890 38 60 00 01  li     %r3, 1
seg000:00118894 48 00 01 DC  b     exit
seg000:00118898
seg000:00118898          loc_118898: # CODE XREF: check3+150j
seg000:00118898 80 DE 00 00  lwz     %r6, dword_24B704
seg000:0011889C 38 81 00 38  addi   %r4, %sp, 0x50+var_18
seg000:001188A0 38 60 00 0B  li     %r3, 0xB
seg000:001188A4 38 A0 00 00  li     %r5, 0
seg000:001188A8 48 00 BF 21  bl     .RBEREAD
seg000:001188AC 60 00 00 00  nop
seg000:001188B0 54 60 04 3F  clrlwi. %r0, %r3, 16
seg000:001188B4 41 82 00 0C  beq    loc_1188C0
seg000:001188B8 38 60 00 00  li     %r3, 0
seg000:001188BC 48 00 01 B4  b     exit
seg000:001188C0
seg000:001188C0          loc_1188C0: # CODE XREF: check3+178j
seg000:001188C0 A0 01 00 38  lhz    %r0, 0x50+var_18(%sp)
seg000:001188C4 28 00 23 1C  cmplwi %r0, 0x1C20
seg000:001188C8 41 82 00 0C  beq    loc_1188D4
seg000:001188CC 38 60 00 00  li     %r3, 0
seg000:001188D0 48 00 01 A0  b     exit
seg000:001188D4
seg000:001188D4          loc_1188D4: # CODE XREF: check3+18Cj
seg000:001188D4 28 1F 00 03  cmplwi %r31, 3
seg000:001188D8 40 82 01 94  bne    error
seg000:001188DC 38 60 00 01  li     %r3, 1
seg000:001188E0 48 00 01 90  b     exit
seg000:001188E4
seg000:001188E4          loc_1188E4: # CODE XREF: check3+A8j
seg000:001188E4 80 DE 00 00  lwz     %r6, dword_24B704
seg000:001188E8 38 81 00 38  addi   %r4, %sp, 0x50+var_18
seg000:001188EC 38 60 00 0C  li     %r3, 0xC
seg000:001188F0 38 A0 00 00  li     %r5, 0
seg000:001188F4 48 00 BE D5  bl     .RBEREAD
seg000:001188F8 60 00 00 00  nop
seg000:001188FC 54 60 04 3F  clrlwi. %r0, %r3, 16
seg000:00118900 41 82 00 0C  beq    loc_11890C
seg000:00118904 38 60 00 00  li     %r3, 0
seg000:00118908 48 00 01 68  b     exit
seg000:0011890C
seg000:0011890C          loc_11890C: # CODE XREF: check3+1C4j
seg000:0011890C A0 01 00 38  lhz    %r0, 0x50+var_18(%sp)
seg000:00118910 28 00 1F 40  cmplwi %r0, 0x40FF
seg000:00118914 41 82 00 0C  beq    loc_118920
seg000:00118918 38 60 00 00  li     %r3, 0
seg000:0011891C 48 00 01 54  b     exit
seg000:00118920
seg000:00118920          loc_118920: # CODE XREF: check3+1D8j
seg000:00118920 57 BF 06 3E  clrlwi  %r31, %r29, 24
seg000:00118924 28 1F 00 02  cmplwi  %r31, 2
seg000:00118928 40 82 00 0C  bne     loc_118934
seg000:0011892C 38 60 00 01  li     %r3, 1
seg000:00118930 48 00 01 40  b     exit
seg000:00118934
seg000:00118934          loc_118934: # CODE XREF: check3+1ECj
seg000:00118934 80 DE 00 00  lwz     %r6, dword_24B704
seg000:00118938 38 81 00 38  addi   %r4, %sp, 0x50+var_18
seg000:0011893C 38 60 00 0D  li     %r3, 0xD
seg000:00118940 38 A0 00 00  li     %r5, 0
seg000:00118944 48 00 BE 85  bl     .RBEREAD
seg000:00118948 60 00 00 00  nop
seg000:0011894C 54 60 04 3F  clrlwi. %r0, %r3, 16
seg000:00118950 41 82 00 0C  beq    loc_11895C
seg000:00118954 38 60 00 00  li     %r3, 0
seg000:00118958 48 00 01 18  b     exit
seg000:0011895C

```

```

seg000:0011895C          loc_11895C: # CODE XREF: check3+214j
seg000:0011895C A0 01 00 38  lhz    %r0, 0x50+var_18(%sp)
seg000:00118960 28 00 07 CF  cmplwi %r0, 0xFC7
seg000:00118964 41 82 00 0C  beq    loc_118970
seg000:00118968 38 60 00 00  li    %r3, 0
seg000:0011896C 48 00 01 04  b     exit
seg000:00118970
seg000:00118970          loc_118970: # CODE XREF: check3+228j
seg000:00118970 28 1F 00 03  cmplwi %r31, 3
seg000:00118974 40 82 00 F8  bne    error
seg000:00118978 38 60 00 01  li    %r3, 1
seg000:0011897C 48 00 00 F4  b     exit
seg000:00118980
seg000:00118980          loc_118980: # CODE XREF: check3+B8j
seg000:00118980          # check3+C4j
seg000:00118980 80 DE 00 00  lwz    %r6, dword_24B704
seg000:00118984 38 81 00 38  addi   %r4, %sp, 0x50+var_18
seg000:00118988 3B E0 00 00  li    %r31, 0
seg000:0011898C 38 60 00 04  li    %r3, 4
seg000:00118990 38 A0 00 00  li    %r5, 0
seg000:00118994 48 00 BE 35  bl    .RBEREAD
seg000:00118998 60 00 00 00  nop
seg000:0011899C 54 60 04 3F  clrlwi.%r0, %r3, 16
seg000:001189A0 41 82 00 0C  beq    loc_1189AC
seg000:001189A4 38 60 00 00  li    %r3, 0
seg000:001189A8 48 00 00 C8  b     exit
seg000:001189AC
seg000:001189AC          loc_1189AC: # CODE XREF: check3+264j
seg000:001189AC A0 01 00 38  lhz    %r0, 0x50+var_18(%sp)
seg000:001189B0 28 00 1D 6A  cmplwi %r0, 0xAED0
seg000:001189B4 40 82 00 0C  bne    loc_1189C0
seg000:001189B8 3B E0 00 01  li    %r31, 1
seg000:001189BC 48 00 00 14  b     loc_1189D0
seg000:001189C0
seg000:001189C0          loc_1189C0: # CODE XREF: check3+278j
seg000:001189C0 28 00 18 28  cmplwi %r0, 0x2818
seg000:001189C4 41 82 00 0C  beq    loc_1189D0
seg000:001189C8 38 60 00 00  li    %r3, 0
seg000:001189CC 48 00 00 A4  b     exit
seg000:001189D0
seg000:001189D0          loc_1189D0: # CODE XREF: check3+280j
seg000:001189D0          # check3+288j
seg000:001189D0 57 A0 06 3E  clrlwi %r0, %r29, 24
seg000:001189D4 28 00 00 02  cmplwi %r0, 2
seg000:001189D8 40 82 00 20  bne    loc_1189F8
seg000:001189DC 57 E0 06 3F  clrlwi.%r0, %r31, 24
seg000:001189E0 41 82 00 10  beq    good2
seg000:001189E4 48 00 4C 69  bl    sub_11D64C
seg000:001189E8 60 00 00 00  nop
seg000:001189EC 48 00 00 84  b     exit
seg000:001189F0
seg000:001189F0          good2:      # CODE XREF: check3+2A4j
seg000:001189F0 38 60 00 01  li    %r3, 1
seg000:001189F4 48 00 00 7C  b     exit
seg000:001189F8
seg000:001189F8          loc_1189F8: # CODE XREF: check3+29Cj
seg000:001189F8 80 DE 00 00  lwz    %r6, dword_24B704
seg000:001189FC 38 81 00 38  addi   %r4, %sp, 0x50+var_18
seg000:00118A00 38 60 00 05  li    %r3, 5
seg000:00118A04 38 A0 00 00  li    %r5, 0
seg000:00118A08 48 00 BD C1  bl    .RBEREAD
seg000:00118A0C 60 00 00 00  nop
seg000:00118A10 54 60 04 3F  clrlwi.%r0, %r3, 16
seg000:00118A14 41 82 00 0C  beq    loc_118A20
seg000:00118A18 38 60 00 00  li    %r3, 0
seg000:00118A1C 48 00 00 54  b     exit
seg000:00118A20
seg000:00118A20          loc_118A20: # CODE XREF: check3+2D8j
seg000:00118A20 A0 01 00 38  lhz    %r0, 0x50+var_18(%sp)
seg000:00118A24 28 00 11 D3  cmplwi %r0, 0xD300

```

```

seg000:00118A28 40 82 00 0C   bne     loc_118A34
seg000:00118A2C 3B E0 00 01   li      %r31, 1
seg000:00118A30 48 00 00 14   b       good1
seg000:00118A34
seg000:00118A34          loc_118A34: # CODE XREF: check3+2ECj
seg000:00118A34 28 00 1A EB   cmplwi %r0, 0xEBA1
seg000:00118A38 41 82 00 0C   beq     good1
seg000:00118A3C 38 60 00 00   li      %r3, 0
seg000:00118A40 48 00 00 30   b       exit
seg000:00118A44
seg000:00118A44          good1:      # CODE XREF: check3+2F4j
seg000:00118A44          # check3+2FCj
seg000:00118A44 57 A0 06 3E   clrlwi %r0, %r29, 24
seg000:00118A48 28 00 00 03   cmplwi %r0, 3
seg000:00118A4C 40 82 00 20   bne     error
seg000:00118A50 57 E0 06 3F   clrlwi. %r0, %r31, 24
seg000:00118A54 41 82 00 10   beq     good
seg000:00118A58 48 00 4B F5   bl      sub_11D64C
seg000:00118A5C 60 00 00 00   nop
seg000:00118A60 48 00 00 10   b       exit
seg000:00118A64
seg000:00118A64          good:      # CODE XREF: check3+318j
seg000:00118A64 38 60 00 01   li      %r3, 1
seg000:00118A68 48 00 00 08   b       exit
seg000:00118A6C
seg000:00118A6C          error:     # CODE XREF: check3+19Cj
seg000:00118A6C          # check3+238j ...
seg000:00118A6C 38 60 00 00   li      %r3, 0
seg000:00118A70
seg000:00118A70          exit:     # CODE XREF: check3+44j
seg000:00118A70          # check3+58j ...
seg000:00118A70 80 01 00 58   lwz    %r0, 0x50+arg_8(%sp)
seg000:00118A74 38 21 00 50   addi   %sp, %sp, 0x50
seg000:00118A78 83 E1 FF FC   lwz    %r31, var_4(%sp)
seg000:00118A7C 7C 08 03 A6   mtlr   %r0
seg000:00118A80 83 C1 FF F8   lwz    %r30, var_8(%sp)
seg000:00118A84 83 A1 FF F4   lwz    %r29, var_C(%sp)
seg000:00118A88 4E 80 00 20   blr
seg000:00118A88          # End of function check3

```

There are a lot of calls to `.RBEREAD()`.

Perhaps, the function returns some values from the dongle, so they are compared here with some hard-coded variables using `CMPLWI`.

We also see that the `r3` register is also filled before each call to `.RBEREAD()` with one of these values: 0, 1, 8, 0xA, 0xB, 0xC, 0xD, 4, 5. Probably a memory address or something like that?

Yes, indeed, by googling these function names it is easy to find the Sentinel Eve3 dongle manual!

Perhaps we don't even have to learn any other PowerPC instructions: all this function does is just call `.RBEREAD()`, compare its results with the constants and returns 1 if the comparisons are fine or 0 otherwise.

OK, all we've got is that `check1()` has always to return 1 or any other non-zero value.

But since we are not very confident in our knowledge of PowerPC instructions, we are going to be careful: we will patch the jumps in `check2()` at `0x001186FC` and `0x00118718`.

At `0x001186FC` we'll write bytes `0x48` and `0` thus converting the `BEQ` instruction in an `B` (unconditional jump): we can spot its opcode in the code without even referring to [PowerPC(tm) Microprocessor Family: The Programming Environments for 32-Bit Microprocessors, (2000)]<sup>16</sup>.

At `0x00118718` we'll write `0x60` and 3 zero bytes, thus converting it to a `NOP` instruction: Its opcode we could spot in the code too.

And now it all works without a dongle connected.

In summary, such small modifications can be done with `IDA` and minimal assembly language knowledge.

<sup>16</sup>Also available as [http://yurichev.com/mirrors/PowerPC/6xx\\_pem.pdf](http://yurichev.com/mirrors/PowerPC/6xx_pem.pdf)

## 8.8.2 Example #2: SCO OpenServer

An ancient software for SCO OpenServer from 1997 developed by a company that disappeared a long time ago.

There is a special dongle driver to be installed in the system, that contains the following text strings: "Copyright 1989, Rainbow Technologies, Inc., Irvine, CA" and "Sentinel Integrated Driver Ver. 3.0".

After the installation of the driver in SCO OpenServer, these device files appear in the /dev filesystem:

```
/dev/rbsl8
/dev/rbsl9
/dev/rbsl10
```

The program reports an error without dongle connected, but the error string cannot be found in the executables.

Thanks to [IDA](#), it is easy to load the COFF executable used in SCO OpenServer.

Let's also try to find "rbsl" string and indeed, found it in this code fragment:

```
.text:00022AB8      public SSQC
.text:00022AB8 SSQC  proc near ; CODE XREF: SSQ+7p
.text:00022AB8
.text:00022AB8 var_44 = byte ptr -44h
.text:00022AB8 var_29 = byte ptr -29h
.text:00022AB8 arg_0  = dword ptr  8
.text:00022AB8
.text:00022AB8      push     ebp
.text:00022AB9      mov      ebp, esp
.text:00022ABB      sub      esp, 44h
.text:00022ABE      push     edi
.text:00022ABF      mov      edi, offset unk_4035D0
.text:00022AC4      push     esi
.text:00022AC5      mov      esi, [ebp+arg_0]
.text:00022AC8      push     ebx
.text:00022AC9      push     esi
.text:00022ACA      call    strlen
.text:00022ACF      add      esp, 4
.text:00022AD2      cmp      eax, 2
.text:00022AD7      jnz     loc_22BA4
.text:00022ADD      inc      esi
.text:00022ADE      mov      al, [esi-1]
.text:00022AE1      movsx   eax, al
.text:00022AE4      cmp      eax, '3'
.text:00022AE9      jz      loc_22B84
.text:00022AEF      cmp      eax, '4'
.text:00022AF4      jz      loc_22B94
.text:00022AFA      cmp      eax, '5'
.text:00022AFF      jnz     short loc_22B6B
.text:00022B01      movsx   ebx, byte ptr [esi]
.text:00022B04      sub      ebx, '0'
.text:00022B07      mov      eax, 7
.text:00022B0C      add      eax, ebx
.text:00022B0E      push     eax
.text:00022B0F      lea     eax, [ebp+var_44]
.text:00022B12      push    offset aDevSlD ; "/dev/sl%d"
.text:00022B17      push     eax
.text:00022B18      call    nl_sprintf
.text:00022B1D      push    0 ; int
.text:00022B1F      push    offset aDevRbsl8 ; char *
.text:00022B24      call    _access
.text:00022B29      add      esp, 14h
.text:00022B2C      cmp      eax, 0FFFFFFFFh
.text:00022B31      jz      short loc_22B48
.text:00022B33      lea     eax, [ebx+7]
.text:00022B36      push     eax
.text:00022B37      lea     eax, [ebp+var_44]
.text:00022B3A      push    offset aDevRbslD ; "/dev/rbsl%d"
.text:00022B3F      push     eax
```

```

.text:00022B40      call    nl_sprintf
.text:00022B45      add     esp, 0Ch
.text:00022B48
.text:00022B48  loc_22B48: ; CODE XREF: SSQC+79j
.text:00022B48      mov     edx, [edi]
.text:00022B4A      test   edx, edx
.text:00022B4C      jle    short loc_22B57
.text:00022B4E      push   edx                ; int
.text:00022B4F      call   _close
.text:00022B54      add     esp, 4
.text:00022B57
.text:00022B57  loc_22B57: ; CODE XREF: SSQC+94j
.text:00022B57      push   2                ; int
.text:00022B59      lea   eax, [ebp+var_44]
.text:00022B5C      push   eax                ; char *
.text:00022B5D      call   _open
.text:00022B62      add     esp, 8
.text:00022B65      test   eax, eax
.text:00022B67      mov   [edi], eax
.text:00022B69      jge    short loc_22B78
.text:00022B6B
.text:00022B6B  loc_22B6B: ; CODE XREF: SSQC+47j
.text:00022B6B      mov   eax, 0FFFFFFFFh
.text:00022B70      pop    ebx
.text:00022B71      pop    esi
.text:00022B72      pop    edi
.text:00022B73      mov   esp, ebp
.text:00022B75      pop    ebp
.text:00022B76      retn
.text:00022B78
.text:00022B78  loc_22B78: ; CODE XREF: SSQC+B1j
.text:00022B78      pop    ebx
.text:00022B79      pop    esi
.text:00022B7A      pop    edi
.text:00022B7B      xor   eax, eax
.text:00022B7D      mov   esp, ebp
.text:00022B7F      pop    ebp
.text:00022B80      retn
.text:00022B84
.text:00022B84  loc_22B84: ; CODE XREF: SSQC+31j
.text:00022B84      mov   al, [esi]
.text:00022B86      pop    ebx
.text:00022B87      pop    esi
.text:00022B88      pop    edi
.text:00022B89      mov   ds:byte_407224, al
.text:00022B8E      mov   esp, ebp
.text:00022B90      xor   eax, eax
.text:00022B92      pop    ebp
.text:00022B93      retn
.text:00022B94
.text:00022B94  loc_22B94: ; CODE XREF: SSQC+3Cj
.text:00022B94      mov   al, [esi]
.text:00022B96      pop    ebx
.text:00022B97      pop    esi
.text:00022B98      pop    edi
.text:00022B99      mov   ds:byte_407225, al
.text:00022B9E      mov   esp, ebp
.text:00022BA0      xor   eax, eax
.text:00022BA2      pop    ebp
.text:00022BA3      retn
.text:00022BA4
.text:00022BA4  loc_22BA4: ; CODE XREF: SSQC+1Fj
.text:00022BA4      movsx eax, ds:byte_407225
.text:00022BAB      push   esi
.text:00022BAC      push   eax
.text:00022BAD      movsx eax, ds:byte_407224
.text:00022BB4      push   eax
.text:00022BB5      lea   eax, [ebp+var_44]
.text:00022BB8      push   offset a46CC5 ; "46%c%c%s"
.text:00022BBD      push   eax

```



```

.text:00022BBE      call    nl_sprintf
.text:00022BC3      lea    eax, [ebp+var_44]
.text:00022BC6      push   eax
.text:00022BC7      call   strlen
.text:00022BCC      add    esp, 18h
.text:00022BCF      cmp    eax, 1Bh
.text:00022BD4      jle    short loc_22BDA
.text:00022BD6      mov    [ebp+var_29], 0
.text:00022BDA
.text:00022BDA loc_22BDA: ; CODE XREF: SSQC+11Cj
.text:00022BDA      lea    eax, [ebp+var_44]
.text:00022BDD      push   eax
.text:00022BDE      call   strlen
.text:00022BE3      push   eax                ; unsigned int
.text:00022BE4      lea    eax, [ebp+var_44]
.text:00022BE7      push   eax                ; void *
.text:00022BE8      mov    eax, [edi]
.text:00022BEA      push   eax                ; int
.text:00022BEB      call   _write
.text:00022BF0      add    esp, 10h
.text:00022BF3      pop    ebx
.text:00022BF4      pop    esi
.text:00022BF5      pop    edi
.text:00022BF6      mov    esp, ebp
.text:00022BF8      pop    ebp
.text:00022BF9      retn
.text:00022BFA      db 0Eh dup(90h)
.text:00022BFA SSQC  endp

```

Yes, indeed, the program needs to communicate with the driver somehow.

The only place where the `SSQC()` function is called is the [thunk function](#):

```

.text:0000DBE8      public SSQ
.text:0000DBE8 SSQ   proc near ; CODE XREF: sys_info+A9p
.text:0000DBE8                ; sys_info+CBp ...
.text:0000DBE8      arg_0 = dword ptr 8
.text:0000DBE8      push   ebp
.text:0000DBE9      mov    ebp, esp
.text:0000DBEB      mov    edx, [ebp+arg_0]
.text:0000DBEE      push   edx
.text:0000DBEF      call   SSQC
.text:0000DBF4      add    esp, 4
.text:0000DBF7      mov    esp, ebp
.text:0000DBF9      pop    ebp
.text:0000DBFA      retn
.text:0000DBFB SSQ   endp

```

`SSQC()` can be called from at least 2 functions.

One of these is:

```

.data:0040169C _51_52_53      dd offset aPressAnyKeyT_0 ; DATA XREF: init_sys+392r
.data:0040169C                ; sys_info+A1r
.data:0040169C                ; "PRESS ANY KEY TO CONTINUE: "
.data:004016A0                dd offset a51                ; "51"
.data:004016A4                dd offset a52                ; "52"
.data:004016A8                dd offset a53                ; "53"
...
.data:004016B8 _3C_or_3E      dd offset a3c                ; DATA XREF: sys_info:loc_D67Br
.data:004016B8                ; "3C"
.data:004016BC                dd offset a3e                ; "3E"

; these names we gave to the labels:
.data:004016C0 answers1      dd 6B05h                    ; DATA XREF: sys_info+E7r
.data:004016C4                dd 3D87h
.data:004016C8 answers2      dd 3Ch                      ; DATA XREF: sys_info+F2r

```

```

.data:004016CC          dd 832h
.data:004016D0  _C_and_B          db 0Ch          ; DATA XREF: sys_info+BAr
.data:004016D0          ; sys_info:OKr
.data:004016D1  byte_4016D1        db 0Bh          ; DATA XREF: sys_info+FDr
.data:004016D2          db 0

...

.text:0000D652          xor     eax, eax
.text:0000D654          mov     al, ds:ctl_port
.text:0000D659          mov     ecx, _51_52_53[eax*4]
.text:0000D660          push   ecx
.text:0000D661          call   SSQ
.text:0000D666          add     esp, 4
.text:0000D669          cmp     eax, 0FFFFFFFh
.text:0000D66E          jz     short loc_D6D1
.text:0000D670          xor     ebx, ebx
.text:0000D672          mov     al, _C_and_B
.text:0000D677          test   al, al
.text:0000D679          jz     short loc_D6C0
.text:0000D67B
.text:0000D67B  loc_D67B: ; CODE XREF: sys_info+106j
.text:0000D67B          mov     eax, _3C_or_3E[ebx*4]
.text:0000D682          push   eax
.text:0000D683          call   SSQ
.text:0000D688          push   offset a4g          ; "4G"
.text:0000D68D          call   SSQ
.text:0000D692          push   offset a0123456789 ; "0123456789"
.text:0000D697          call   SSQ
.text:0000D69C          add     esp, 0Ch
.text:0000D69F          mov     edx, answers1[ebx*4]
.text:0000D6A6          cmp     eax, edx
.text:0000D6A8          jz     short OK
.text:0000D6AA          mov     ecx, answers2[ebx*4]
.text:0000D6B1          cmp     eax, ecx
.text:0000D6B3          jz     short OK
.text:0000D6B5          mov     al, byte_4016D1[ebx]
.text:0000D6BB          inc     ebx
.text:0000D6BC          test   al, al
.text:0000D6BE          jnz   short loc_D67B
.text:0000D6C0
.text:0000D6C0  loc_D6C0: ; CODE XREF: sys_info+C1j
.text:0000D6C0          inc     ds:ctl_port
.text:0000D6C6          xor     eax, eax
.text:0000D6C8          mov     al, ds:ctl_port
.text:0000D6CD          cmp     eax, edi
.text:0000D6CF          jle   short loc_D652
.text:0000D6D1
.text:0000D6D1  loc_D6D1: ; CODE XREF: sys_info+98j
.text:0000D6D1          ; sys_info+B6j
.text:0000D6D1          mov     edx, [ebp+var_8]
.text:0000D6D4          inc     edx
.text:0000D6D5          mov     [ebp+var_8], edx
.text:0000D6D8          cmp     edx, 3
.text:0000D6DB          jle   loc_D641
.text:0000D6E1
.text:0000D6E1  loc_D6E1: ; CODE XREF: sys_info+16j
.text:0000D6E1          ; sys_info+51j ...
.text:0000D6E1          pop     ebx
.text:0000D6E2          pop     edi
.text:0000D6E3          mov     esp, ebp
.text:0000D6E5          pop     ebp
.text:0000D6E6          retn
.text:0000D6E8  OK: ; CODE XREF: sys_info+F0j
.text:0000D6E8          ; sys_info+FBj
.text:0000D6E8          mov     al, _C_and_B[ebx]
.text:0000D6EE          pop     ebx
.text:0000D6EF          pop     edi
.text:0000D6F0          mov     ds:ctl_model, al
.text:0000D6F5          mov     esp, ebp

```

```
.text:0000D6F7          pop     ebp
.text:0000D6F8          retn
.text:0000D6F8 sys_info  endp
```

“3C” and “3E” sound familiar: there was a Sentinel Pro dongle by Rainbow with no memory, providing only one crypto-hashing secret function.

You can read a short description of what hash function is here: [2.11 on page 467](#).

But let’s get back to the program.

So the program can only check the presence or absence of a connected dongle.

No other information can be written to such dongle, as it has no memory. The two-character codes are commands (we can see how the commands are handled in the SSQC() function) and all other strings are hashed inside the dongle, being transformed into a 16-bit number. The algorithm was secret, so it was not possible to write a driver replacement or to remake the dongle hardware that would emulate it perfectly.

However, it is always possible to intercept all accesses to it and to find what constants the hash function results are compared to.

But we need to say that it is possible to build a robust software copy protection scheme based on secret cryptographic hash-function: let it encrypt/decrypt the data files your software uses.

But let’s get back to the code.

Codes 51/52/53 are used for LPT printer port selection. 3x/4x are used for “family” selection (that’s how Sentinel Pro dongles are differentiated from each other: more than one dongle can be connected to a LPT port).

The only non-2-character string passed to the hashing function is “0123456789”.

Then, the result is compared against the set of valid results.

If it is correct, 0xC or 0xB is to be written into the global variable `ctl_model`.

Another text string that gets passed is “PRESS ANY KEY TO CONTINUE: ”, but the result is not checked. Hard to say why, probably by mistake <sup>17</sup>.

Let’s see where the value from the global variable `ctl_model` is used.

One such place is:

```
.text:0000D708 prep_sys proc near ; CODE XREF: init_sys+46Ap
.text:0000D708
.text:0000D708 var_14 = dword ptr -14h
.text:0000D708 var_10 = byte ptr -10h
.text:0000D708 var_8 = dword ptr -8
.text:0000D708 var_2 = word ptr -2
.text:0000D708
.text:0000D708          push     ebp
.text:0000D709          mov     eax, ds:net_env
.text:0000D70E          mov     ebp, esp
.text:0000D710          sub     esp, 1Ch
.text:0000D713          test    eax, eax
.text:0000D715          jnz    short loc_D734
.text:0000D717          mov     al, ds:ctl_model
.text:0000D71C          test    al, al
.text:0000D71E          jnz    short loc_D77E
.text:0000D720          mov     [ebp+var_8], offset aIeCvulnvV0kgT_ ; "Ie-cvulnvV\\b0KG]T_"
.text:0000D727          mov     edx, 7
.text:0000D72C          jmp     loc_D7E7

...

.text:0000D7E7 loc_D7E7: ; CODE XREF: prep_sys+24j
.text:0000D7E7          ; prep_sys+33j
.text:0000D7E7          push    edx
.text:0000D7E8          mov     edx, [ebp+var_8]
.text:0000D7EB          push    20h
.text:0000D7ED          push    edx
.text:0000D7EE          push    16h
```

<sup>17</sup>What a strange feeling: to find bugs in such ancient software.

```

.text:0000D7F0      call   err_warn
.text:0000D7F5      push   offset station_sem
.text:0000D7FA      call   ClosSem
.text:0000D7FF      call   startup_err

```

If it is 0, an encrypted error message is passed to a decryption routine and printed.

The error string decryption routine seems a simple [xoring](#):

```

.text:0000A43C  err_warn      proc near          ; CODE XREF: prep_sys+E8p
.text:0000A43C                                     ; prep_sys2+2Fp ...
.text:0000A43C
.text:0000A43C  var_55       = byte ptr -55h
.text:0000A43C  var_54       = byte ptr -54h
.text:0000A43C  arg_0        = dword ptr  8
.text:0000A43C  arg_4        = dword ptr  0Ch
.text:0000A43C  arg_8        = dword ptr  10h
.text:0000A43C  arg_C        = dword ptr  14h
.text:0000A43C                                     push   ebp
.text:0000A43D                                     mov    ebp, esp
.text:0000A43F                                     sub    esp, 54h
.text:0000A442                                     push   edi
.text:0000A443                                     mov    ecx, [ebp+arg_8]
.text:0000A446                                     xor    edi, edi
.text:0000A448                                     test   ecx, ecx
.text:0000A44A                                     push   esi
.text:0000A44B                                     jle    short loc_A466
.text:0000A44D                                     mov    esi, [ebp+arg_C] ; key
.text:0000A450                                     mov    edx, [ebp+arg_4] ; string
.text:0000A453
.text:0000A453  loc_A453:                                     ; CODE XREF: err_warn+28j
.text:0000A453                                     xor    eax, eax
.text:0000A455                                     mov    al, [edx+edi]
.text:0000A458                                     xor    eax, esi
.text:0000A45A                                     add    esi, 3
.text:0000A45D                                     inc    edi
.text:0000A45E                                     cmp    edi, ecx
.text:0000A460                                     mov    [ebp+edi+var_55], al
.text:0000A464                                     jl     short loc_A453
.text:0000A466
.text:0000A466  loc_A466:                                     ; CODE XREF: err_warn+Fj
.text:0000A466                                     mov    [ebp+edi+var_54], 0
.text:0000A46B                                     mov    eax, [ebp+arg_0]
.text:0000A46E                                     cmp    eax, 18h
.text:0000A473                                     jnz    short loc_A49C
.text:0000A475                                     lea   eax, [ebp+var_54]
.text:0000A478                                     push  eax
.text:0000A479                                     call  status_line
.text:0000A47E                                     add   esp, 4
.text:0000A481
.text:0000A481  loc_A481:                                     ; CODE XREF: err_warn+72j
.text:0000A481                                     push  50h
.text:0000A483                                     push  0
.text:0000A485                                     lea   eax, [ebp+var_54]
.text:0000A488                                     push  eax
.text:0000A489                                     call  memset
.text:0000A48E                                     call  pcw_refresh
.text:0000A493                                     add   esp, 0Ch
.text:0000A496                                     pop   esi
.text:0000A497                                     pop   edi
.text:0000A498                                     mov   esp, ebp
.text:0000A49A                                     pop   ebp
.text:0000A49B                                     retn
.text:0000A49C
.text:0000A49C  loc_A49C:                                     ; CODE XREF: err_warn+37j
.text:0000A49C                                     push  0
.text:0000A49E                                     lea   eax, [ebp+var_54]
.text:0000A4A1                                     mov   edx, [ebp+arg_0]
.text:0000A4A4                                     push  edx

```

```

.text:0000A4A5      push    eax
.text:0000A4A6      call   pcvt_lputs
.text:0000A4AB      add    esp, 0Ch
.text:0000A4AE      jmp    short loc_A481
.text:0000A4AE err_warn      endp

```

That's why we were unable to find the error messages in the executable files, because they are encrypted (which is popular practice).

Another call to the SSQ() hashing function passes the "offln" string to it and compares the result with 0xFE81 and 0x12A9.

If they don't match, it works with some timer() function (maybe waiting for a poorly connected dongle to be reconnected and check again?) and then decrypts another error message to dump.

```

.text:0000DA55 loc_DA55:                ; CODE XREF: sync_sys+24Cj
.text:0000DA55      push   offset a0ffln ; "offln"
.text:0000DA5A      call  SSQ
.text:0000DA5F      add   esp, 4
.text:0000DA62      mov   dl, [ebx]
.text:0000DA64      mov   esi, eax
.text:0000DA66      cmp   dl, 0Bh
.text:0000DA69      jnz  short loc_DA83
.text:0000DA6B      cmp   esi, 0FE81h
.text:0000DA71      jz   OK
.text:0000DA77      cmp   esi, 0FFFFFF8EFh
.text:0000DA7D      jz   OK
.text:0000DA83 loc_DA83:                ; CODE XREF: sync_sys+201j
.text:0000DA83      mov   cl, [ebx]
.text:0000DA85      cmp   cl, 0Ch
.text:0000DA88      jnz  short loc_DA9F
.text:0000DA8A      cmp   esi, 12A9h
.text:0000DA90      jz   OK
.text:0000DA96      cmp   esi, 0FFFFFFF5h
.text:0000DA99      jz   OK
.text:0000DA9F loc_DA9F:                ; CODE XREF: sync_sys+220j
.text:0000DA9F      mov   eax, [ebp+var_18]
.text:0000DAA2      test  eax, eax
.text:0000DAA4      jz   short loc_DAB0
.text:0000DAA6      push  24h
.text:0000DAA8      call  timer
.text:0000DAAD      add   esp, 4
.text:0000DAB0 loc_DAB0:                ; CODE XREF: sync_sys+23Cj
.text:0000DAB0      inc   edi
.text:0000DAB1      cmp   edi, 3
.text:0000DAB4      jle  short loc_DA55
.text:0000DAB6      mov   eax, ds:net_env
.text:0000DABB      test  eax, eax
.text:0000DABD      jz   short error
...
.text:0000DAF7 error:                ; CODE XREF: sync_sys+255j
.text:0000DAF7                ; sync_sys+274j ...
.text:0000DAF7      mov   [ebp+var_8], offset encrypted_error_message2
.text:0000DAFE      mov   [ebp+var_C], 17h ; decrypting key
.text:0000DB05      jmp  decrypt_end_print_message
...
; this name we gave to label:
.text:0000D9B6 decrypt_end_print_message: ; CODE XREF: sync_sys+29Dj
.text:0000D9B6                ; sync_sys+2ABj
.text:0000D9B6      mov   eax, [ebp+var_18]
.text:0000D9B9      test  eax, eax
.text:0000D9BB      jnz  short loc_D9FB
.text:0000D9BD      mov   edx, [ebp+var_C] ; key

```

```

.text:0000D9C0      mov     ecx, [ebp+var_8] ; string
.text:0000D9C3      push   edx
.text:0000D9C4      push   20h
.text:0000D9C6      push   ecx
.text:0000D9C7      push   18h
.text:0000D9C9      call   err_warn
.text:0000D9CE      push   0Fh
.text:0000D9D0      push   190h
.text:0000D9D5      call   sound
.text:0000D9DA      mov     [ebp+var_18], 1
.text:0000D9E1      add    esp, 18h
.text:0000D9E4      call   pc_v_kbhit
.text:0000D9E9      test   eax, eax
.text:0000D9EB      jz     short loc_D9FB

...

; this name we gave to label:
.data:00401736 encrypted_error_message2 db 74h, 72h, 78h, 43h, 48h, 6, 5Ah, 49h, 4Ch, 2 dup(47h↵
↵ )
.data:00401736      db 51h, 4Fh, 47h, 61h, 20h, 22h, 3Ch, 24h, 33h, 36h, 76h
.data:00401736      db 3Ah, 33h, 31h, 0Ch, 0, 0Bh, 1Fh, 7, 1Eh, 1Ah

```

Bypassing the dongle is pretty straightforward: just patch all jumps after the relevant CMP instructions.

Another option is to write our own SCO OpenServer driver, containing a table of questions and answers, all of those which present in the program.

## Decrypting error messages

By the way, we can also try to decrypt all error messages. The algorithm that is located in the `err_warn()` function is very simple, indeed:

Listing 8.5: Decryption function

```

.text:0000A44D      mov     esi, [ebp+arg_C] ; key
.text:0000A450      mov     edx, [ebp+arg_4] ; string
.text:0000A453 loc_A453:
.text:0000A453      xor     eax, eax
.text:0000A455      mov     al, [edx+edi] ; load encrypted byte
.text:0000A458      xor     eax, esi      ; decrypt it
.text:0000A45A      add     esi, 3        ; change key for the next byte
.text:0000A45D      inc     edi
.text:0000A45E      cmp     edi, ecx
.text:0000A460      mov     [ebp+edi+var_55], al
.text:0000A464      jl     short loc_A453

```

As we can see, not just string is supplied to the decryption function, but also the key:

```

.text:0000DAF7 error: ; CODE XREF: sync_sys+255j
.text:0000DAF7 ; sync_sys+274j ...
.text:0000DAF7      mov     [ebp+var_8], offset encrypted_error_message2
.text:0000DAFE      mov     [ebp+var_C], 17h ; decrypting key
.text:0000DB05      jmp    decrypt_end_print_message

...

; this name we gave to label manually:
.text:0000D9B6 decrypt_end_print_message: ; CODE XREF: sync_sys+29Dj
.text:0000D9B6 ; sync_sys+2ABj
.text:0000D9B6      mov     eax, [ebp+var_18]
.text:0000D9B9      test   eax, eax
.text:0000D9BB      jnz    short loc_D9FB
.text:0000D9BD      mov     edx, [ebp+var_C] ; key
.text:0000D9C0      mov     ecx, [ebp+var_8] ; string
.text:0000D9C3      push   edx
.text:0000D9C4      push   20h
.text:0000D9C6      push   ecx
.text:0000D9C7      push   18h
.text:0000D9C9      call   err_warn

```

The algorithm is a simple [XORing](#): each byte is xored with a key, but the key is increased by 3 after the processing of each byte.

We can write a simple Python script to check our hypothesis:

Listing 8.6: Python 3.x

```
#!/usr/bin/python
import sys

msg=[0x74, 0x72, 0x78, 0x43, 0x48, 0x6, 0x5A, 0x49, 0x4C, 0x47, 0x47,
0x51, 0x4F, 0x47, 0x61, 0x20, 0x22, 0x3C, 0x24, 0x33, 0x36, 0x76,
0x3A, 0x33, 0x31, 0x0C, 0x0, 0x0B, 0x1F, 0x7, 0x1E, 0x1A]

key=0x17
tmp=key
for i in msg:
    sys.stdout.write ("%c" % (i^tmp))
    tmp=tmp+3
sys.stdout.flush()
```

And it prints: “check security device connection”. So yes, this is the decrypted message.

There are also other encrypted messages with their corresponding keys. But needless to say, it is possible to decrypt them without their keys. First, we can see that the key is in fact a byte. It is because the core decryption instruction (XOR) works on byte level. The key is located in the ESI register, but only one byte part of ESI is used. Hence, a key may be greater than 255, but its value is always to be rounded.

As a consequence, we can just try brute-force, trying all possible keys in the 0..255 range. We are also going to skip the messages that has unprintable characters.

Listing 8.7: Python 3.x

```
#!/usr/bin/python
import sys, curses.ascii

msgs=[
[0x74, 0x72, 0x78, 0x43, 0x48, 0x6, 0x5A, 0x49, 0x4C, 0x47, 0x47,
0x51, 0x4F, 0x47, 0x61, 0x20, 0x22, 0x3C, 0x24, 0x33, 0x36, 0x76,
0x3A, 0x33, 0x31, 0x0C, 0x0, 0x0B, 0x1F, 0x7, 0x1E, 0x1A],

[0x49, 0x65, 0x2D, 0x63, 0x76, 0x75, 0x6C, 0x6E, 0x76, 0x56, 0x5C,
8, 0x4F, 0x4B, 0x47, 0x5D, 0x54, 0x5F, 0x1D, 0x26, 0x2C, 0x33,
0x27, 0x28, 0x6F, 0x72, 0x75, 0x78, 0x7B, 0x7E, 0x41, 0x44],

[0x45, 0x61, 0x31, 0x67, 0x72, 0x79, 0x68, 0x52, 0x4A, 0x52, 0x50,
0x0C, 0x4B, 0x57, 0x43, 0x51, 0x58, 0x5B, 0x61, 0x37, 0x33, 0x2B,
0x39, 0x39, 0x3C, 0x38, 0x79, 0x3A, 0x30, 0x17, 0x0B, 0x0C],

[0x40, 0x64, 0x79, 0x75, 0x7F, 0x6F, 0x0, 0x4C, 0x40, 0x9, 0x4D, 0x5A,
0x46, 0x5D, 0x57, 0x49, 0x57, 0x3B, 0x21, 0x23, 0x6A, 0x38, 0x23,
0x36, 0x24, 0x2A, 0x7C, 0x3A, 0x1A, 0x6, 0x0D, 0x0E, 0x0A, 0x14,
0x10],

[0x72, 0x7C, 0x72, 0x79, 0x76, 0x0,
0x50, 0x43, 0x4A, 0x59, 0x5D, 0x5B, 0x41, 0x41, 0x1B, 0x5A,
0x24, 0x32, 0x2E, 0x29, 0x28, 0x70, 0x20, 0x22, 0x38, 0x28, 0x36,
0x0D, 0x0B, 0x48, 0x4B, 0x4E]]

def is_string_printable(s):
    return all(list(map(lambda x: curses.ascii.isprint(x), s)))

cnt=1
for msg in msgs:
    print ("message #%" % cnt)
    for key in range(0,256):
        result=[]
        tmp=key
        for i in msg:
            result.append (i^tmp)
            tmp=tmp+3
```

```

        if is_string_printable (result):
            print ("key=", key, "value=", "".join(list(map(chr, result))))
cnt=cnt+1

```

And we get:

Listing 8.8: Results

```

message #1
key= 20 value= `eb^h%|``hudw|_af{n~f%ljmSbnwlpk
key= 21 value= ajc]i"}cawtgv{^bgto}g"millcmvkqh
key= 22 value= bkd\j#rbbvsfuz!cduh|d#bhomdlujni
key= 23 value= check security device connection
key= 24 value= lifbl!pd|tqhsx#ejwjbb!`nQofbshlo
message #2
key= 7 value= No security device found
key= 8 value= An#rbbvsVuz!cduhld#ghtme?!#!'#!
message #3
key= 7 value= Bk<waoqNUpu$`yrea\wpmpusj,bkIjh
key= 8 value= Mj?vfnr0jqv%gxqd``_vwlstlk/clHii
key= 9 value= Lm>ugasLkvw&fgpgag^uvcwml.`mwhj
key= 10 value= 0l!td`tmhwx'efwfbf!tubvnm!anvok
key= 11 value= No security device station found
key= 12 value= In#rjbvsnuz!{duhdd#r{`whho#gPtme
message #4
key= 14 value= Number of authorized users exceeded
key= 15 value= 0vlmdq!hg#`juknuhydk!vrbsp!Zy`dbefe
message #5
key= 17 value= check security device station
key= 18 value= `ijbh!td`tmhwx'efwfbf!tubuVnm!'!

```

There is some garbage, but we can quickly find the English-language messages!

By the way, since the algorithm is a simple xoring encryption, the very same function can be used to encrypt messages. If needed, we can encrypt our own messages, and patch the program by inserting them.

### 8.8.3 Example #3: MS-DOS

Another very old software for MS-DOS from 1995 also developed by a company that disappeared a long time ago.

In the pre-DOS extenders era, all the software for MS-DOS mostly relied on 16-bit 8086 or 80286 CPUs, so the code was 16-bit en masse.

The 16-bit code is mostly same as you already saw in this book, but all registers are 16-bit and there are less instructions available.

The MS-DOS environment has no system drivers, and any program can deal with the bare hardware via ports, so here you can see the OUT/IN instructions, which are present in mostly in drivers in our times (it is impossible to access ports directly in [user mode](#) on all modern [OSes](#)).

Given that, the MS-DOS program which works with a dongle has to access the LPT printer port directly.

So we can just search for such instructions. And yes, here they are:

```

seg030:0034          out_port proc far ; CODE XREF: sent_pro+22p
seg030:0034                      ; sent_pro+2Ap ...
seg030:0034
seg030:0034          arg_0      = byte ptr 6
seg030:0034
seg030:0034 55                push     bp
seg030:0035 8B EC            mov     bp, sp
seg030:0037 8B 16 7E E7      mov     dx, _out_port ; 0x378
seg030:003B 8A 46 06         mov     al, [bp+arg_0]
seg030:003E EE                out     dx, al
seg030:003F 5D                pop     bp
seg030:0040 CB                retf
seg030:0040          out_port endp

```



(All label names in this example were given by me).

out\_port() is referenced only in one function:

```
seg030:0041          sent_pro proc far ; CODE XREF: check_dongle+34p
seg030:0041
seg030:0041          var_3      = byte ptr -3
seg030:0041          var_2      = word ptr -2
seg030:0041          arg_0      = dword ptr  6
seg030:0041
seg030:0041 C8 04 00 00          enter    4, 0
seg030:0045 56                    push    si
seg030:0046 57                    push    di
seg030:0047 8B 16 82 E7          mov     dx, _in_port_1 ; 0x37A
seg030:004B EC                    in     al, dx
seg030:004C 8A D8                mov     bl, al
seg030:004E 80 E3 FE            and     bl, 0FEh
seg030:0051 80 CB 04            or     bl, 4
seg030:0054 8A C3                mov     al, bl
seg030:0056 88 46 FD            mov     [bp+var_3], al
seg030:0059 80 E3 1F            and     bl, 1Fh
seg030:005C 8A C3                mov     al, bl
seg030:005E EE                    out    dx, al
seg030:005F 68 FF 00            push   0FFh
seg030:0062 0E                    push   cs
seg030:0063 E8 CE FF            call   near ptr out_port
seg030:0066 59                    pop    cx
seg030:0067 68 D3 00            push   0D3h
seg030:006A 0E                    push   cs
seg030:006B E8 C6 FF            call   near ptr out_port
seg030:006E 59                    pop    cx
seg030:006F 33 F6                xor    si, si
seg030:0071 EB 01                jmp    short loc_359D4
seg030:0073
seg030:0073          loc_359D3: ; CODE XREF: sent_pro+37j
seg030:0073 46                    inc    si
seg030:0074
seg030:0074          loc_359D4: ; CODE XREF: sent_pro+30j
seg030:0074 81 FE 96 00          cmp    si, 96h
seg030:0078 7C F9                jl     short loc_359D3
seg030:007A 68 C3 00            push   0C3h
seg030:007D 0E                    push   cs
seg030:007E E8 B3 FF            call   near ptr out_port
seg030:0081 59                    pop    cx
seg030:0082 68 C7 00            push   0C7h
seg030:0085 0E                    push   cs
seg030:0086 E8 AB FF            call   near ptr out_port
seg030:0089 59                    pop    cx
seg030:008A 68 D3 00            push   0D3h
seg030:008D 0E                    push   cs
seg030:008E E8 A3 FF            call   near ptr out_port
seg030:0091 59                    pop    cx
seg030:0092 68 C3 00            push   0C3h
seg030:0095 0E                    push   cs
seg030:0096 E8 9B FF            call   near ptr out_port
seg030:0099 59                    pop    cx
seg030:009A 68 C7 00            push   0C7h
seg030:009D 0E                    push   cs
seg030:009E E8 93 FF            call   near ptr out_port
seg030:00A1 59                    pop    cx
seg030:00A2 68 D3 00            push   0D3h
seg030:00A5 0E                    push   cs
seg030:00A6 E8 8B FF            call   near ptr out_port
seg030:00A9 59                    pop    cx
seg030:00AA BF FF FF            mov    di, 0FFFFh
seg030:00AD EB 40                jmp    short loc_35A4F
seg030:00AF
seg030:00AF          loc_35A0F: ; CODE XREF: sent_pro+BDj
seg030:00AF BE 04 00            mov    si, 4
seg030:00B2
seg030:00B2          loc_35A12: ; CODE XREF: sent_pro+ACj
```

```

seg030:00B2 D1 E7          shl     di, 1
seg030:00B4 8B 16 80 E7        mov     dx, _in_port_2 ; 0x379
seg030:00B8 EC                in      al, dx
seg030:00B9 A8 80            test   al, 80h
seg030:00BB 75 03            jnz    short loc_35A20
seg030:00BD 83 CF 01         or      di, 1
seg030:00C0
seg030:00C0          loc_35A20: ; CODE XREF: sent_pro+7Aj
seg030:00C0 F7 46 FE 08+      test   [bp+var_2], 8
seg030:00C5 74 05            jz     short loc_35A2C
seg030:00C7 68 D7 00         push   0D7h ; '+'
seg030:00CA EB 0B            jmp    short loc_35A37
seg030:00CC
seg030:00CC          loc_35A2C: ; CODE XREF: sent_pro+84j
seg030:00CC 68 C3 00         push   0C3h
seg030:00CF 0E                push   cs
seg030:00D0 E8 61 FF         call   near ptr out_port
seg030:00D3 59                pop    cx
seg030:00D4 68 C7 00         push   0C7h
seg030:00D7
seg030:00D7          loc_35A37: ; CODE XREF: sent_pro+89j
seg030:00D7 0E                push   cs
seg030:00D8 E8 59 FF         call   near ptr out_port
seg030:00DB 59                pop    cx
seg030:00DC 68 D3 00         push   0D3h
seg030:00DF 0E                push   cs
seg030:00E0 E8 51 FF         call   near ptr out_port
seg030:00E3 59                pop    cx
seg030:00E4 8B 46 FE         mov     ax, [bp+var_2]
seg030:00E7 D1 E0            shl     ax, 1
seg030:00E9 89 46 FE         mov     [bp+var_2], ax
seg030:00EC 4E                dec     si
seg030:00ED 75 C3            jnz    short loc_35A12
seg030:00EF
seg030:00EF          loc_35A4F: ; CODE XREF: sent_pro+6Cj
seg030:00EF C4 5E 06         les     bx, [bp+arg_0]
seg030:00F2 FF 46 06         inc     word ptr [bp+arg_0]
seg030:00F5 26 8A 07         mov     al, es:[bx]
seg030:00F8 98                cbw
seg030:00F9 89 46 FE         mov     [bp+var_2], ax
seg030:00FC 0B C0            or      ax, ax
seg030:00FE 75 AF            jnz    short loc_35A0F
seg030:0100 68 FF 00         push   0FFh
seg030:0103 0E                push   cs
seg030:0104 E8 2D FF         call   near ptr out_port
seg030:0107 59                pop    cx
seg030:0108 8B 16 82 E7        mov     dx, _in_port_1 ; 0x37A
seg030:010C EC                in      al, dx
seg030:010D 8A C8            mov     cl, al
seg030:010F 80 E1 5F         and     cl, 5Fh
seg030:0112 8A C1            mov     al, cl
seg030:0114 EE                out     dx, al
seg030:0115 EC                in      al, dx
seg030:0116 8A C8            mov     cl, al
seg030:0118 F6 C1 20         test   cl, 20h
seg030:011B 74 08            jz     short loc_35A85
seg030:011D 8A 5E FD         mov     bl, [bp+var_3]
seg030:0120 80 E3 DF         and     bl, 0DFh
seg030:0123 EB 03            jmp    short loc_35A88
seg030:0125
seg030:0125          loc_35A85: ; CODE XREF: sent_pro+DAj
seg030:0125 8A 5E FD         mov     bl, [bp+var_3]
seg030:0128
seg030:0128          loc_35A88: ; CODE XREF: sent_pro+E2j
seg030:0128 F6 C1 80         test   cl, 80h
seg030:012B 74 03            jz     short loc_35A90
seg030:012D 80 E3 7F         and     bl, 7Fh
seg030:0130
seg030:0130          loc_35A90: ; CODE XREF: sent_pro+EAj
seg030:0130 8B 16 82 E7        mov     dx, _in_port_1 ; 0x37A

```

```

seg030:0134 8A C3          mov     al, bl
seg030:0136 EE          out     dx, al
seg030:0137 8B C7          mov     ax, di
seg030:0139 5F          pop     di
seg030:013A 5E          pop     si
seg030:013B C9          leave
seg030:013C CB          retf
seg030:013C          sent_pro endp

```

This is again a Sentinel Pro “hashing” dongle as in the previous example. It is noticeable because text strings are passed here, too, and 16 bit values are returned and compared with others.

So that is how Sentinel Pro is accessed via ports.

The output port address is usually 0x378, i.e., the printer port, where the data to the old printers in pre-USB era was passed to.

The port is uni-directional, because when it was developed, no one imagined that someone will need to transfer information from the printer <sup>18</sup>.

The only way to get information from the printer is a status register on port 0x379, which contains such bits as “paper out”, “ack”, “busy”—thus the printer may signal to the host computer if it is ready or not and if paper is present in it.

So the dongle returns information from one of these bits, one bit at each iteration.

`_in_port_2` contains the address of the status word (0x379) and `_in_port_1` contains the control register address (0x37A).

It seems that the dongle returns information via the “busy” flag at `seg030:00B9`: each bit is stored in the DI register, which is returned at the end of the function.

What do all these bytes sent to output port mean? Hard to say. Perhaps, commands to the dongle.

But generally speaking, it is not necessary to know: it is easy to solve our task without that knowledge.

Here is the dongle checking routine:

```

00000000 struct_0      struc ; (sizeof=0x1B)
00000000 field_0      db 25 dup(?)          ; string(C)
00000019 _A          dw ?
0000001B struct_0      ends

dseg:3CBC 61 63 72 75+_Q struct_0 <'hello', 01122h>
dseg:3CBC 6E 00 00 00+   ; DATA XREF: check_dongle+2Eo

... skipped ...

dseg:3E00 63 6F 66 66+   struct_0 <'coffee', 7EB7h>
dseg:3E1B 64 6F 67 00+   struct_0 <'dog', 0FFADh>
dseg:3E36 63 61 74 00+   struct_0 <'cat', 0FF5Fh>
dseg:3E51 70 61 70 65+   struct_0 <'paper', 0FFDFh>
dseg:3E6C 63 6F 6B 65+   struct_0 <'coke', 0F568h>
dseg:3E87 63 6C 6F 63+   struct_0 <'clock', 55EAh>
dseg:3EA2 64 69 72 00+   struct_0 <'dir', 0FFAEh>
dseg:3EBD 63 6F 70 79+   struct_0 <'copy', 0F557h>

seg030:0145          check_dongle proc far ; CODE XREF: sub_3771D+3EP
seg030:0145
seg030:0145          var_6 = dword ptr -6
seg030:0145          var_2 = word ptr -2
seg030:0145
seg030:0145 C8 06 00 00          enter    6, 0
seg030:0149 56          push    si
seg030:014A 66 6A 00          push    large 0          ; newtime
seg030:014D 6A 00          push    0                ; cmd
seg030:014F 9A C1 18 00+       call    _biostime
seg030:0154 52          push    dx
seg030:0155 50          push    ax
seg030:0156 66 58          pop     eax

```

<sup>18</sup>If we consider Centronics only. The following IEEE 1284 standard allows the transfer of information from the printer.

```

seg030:0158 83 C4 06      add     sp, 6
seg030:015B 66 89 46 FA      mov     [bp+var_6], eax
seg030:015F 66 3B 06 D8+     cmp     eax, _expiration
seg030:0164 7E 44           jle     short loc_35B0A
seg030:0166 6A 14           push    14h
seg030:0168 90             nop
seg030:0169 0E             push    cs
seg030:016A E8 52 00       call   near ptr get_rand
seg030:016D 59             pop     cx
seg030:016E 8B F0         mov     si, ax
seg030:0170 6B C0 1B      imul   ax, 1Bh
seg030:0173 05 BC 3C      add     ax, offset _Q
seg030:0176 1E             push    ds
seg030:0177 50             push    ax
seg030:0178 0E             push    cs
seg030:0179 E8 C5 FE      call   near ptr sent_pro
seg030:017C 83 C4 04      add     sp, 4
seg030:017F 89 46 FE      mov     [bp+var_2], ax
seg030:0182 8B C6         mov     ax, si
seg030:0184 6B C0 12      imul   ax, 18
seg030:0187 66 0F BF C0    movsx  eax, ax
seg030:018B 66 8B 56 FA    mov     edx, [bp+var_6]
seg030:018F 66 03 D0      add     edx, eax
seg030:0192 66 89 16 D8+   mov     _expiration, edx
seg030:0197 8B DE         mov     bx, si
seg030:0199 6B DB 1B      imul   bx, 27
seg030:019C 8B 87 D5 3C    mov     ax, _Q._A[bx]
seg030:01A0 3B 46 FE      cmp     ax, [bp+var_2]
seg030:01A3 74 05         jz      short loc_35B0A
seg030:01A5 B8 01 00      mov     ax, 1
seg030:01A8 EB 02         jmp     short loc_35B0C
seg030:01AA                loc_35B0A: ; CODE XREF: check_dongle+1Fj
seg030:01AA                ; check_dongle+5Ej
seg030:01AA 33 C0         xor     ax, ax
seg030:01AC                loc_35B0C: ; CODE XREF: check_dongle+63j
seg030:01AC 5E             pop     si
seg030:01AD C9             leave
seg030:01AE CB             retf
seg030:01AE                check_dongle endp

```

Since the routine can be called very frequently, e.g., before the execution of each important software feature, and accessing the dongle is generally slow (because of the slow printer port and also slow **MCU** in the dongle), they probably added a way to skip some dongle checks, by checking the current time in the `biostime()` function.

The `get_rand()` function uses the standard C function:

```

seg030:01BF                get_rand proc far ; CODE XREF: check_dongle+25p
seg030:01BF                arg_0      = word ptr 6
seg030:01BF                push     bp
seg030:01C0 8B EC         mov     bp, sp
seg030:01C2 9A 3D 21 00+   call   _rand
seg030:01C7 66 0F BF C0    movsx  eax, ax
seg030:01CB 66 0F BF 56+   movsx  edx, [bp+arg_0]
seg030:01D0 66 0F AF C2    imul   eax, edx
seg030:01D4 66 BB 00 80+   mov     ebx, 8000h
seg030:01DA 66 99         cdq
seg030:01DC 66 F7 FB      idiv   ebx
seg030:01DF 5D             pop     bp
seg030:01E0 CB             retf
seg030:01E0                get_rand endp

```

So the text string is selected randomly, passed into the dongle, and then the result of the hashing is compared with the correct value.

The text strings seem to be constructed randomly as well, during software development.

And this is how the main dongle checking function is called:

```
seg033:087B 9A 45 01 96+ call check_dongle
seg033:0880 0B C0      or ax, ax
seg033:0882 74 62      jz short OK
seg033:0884 83 3E 60 42+ cmp word_620E0, 0
seg033:0889 75 5B      jnz short OK
seg033:088B FF 06 60 42 inc word_620E0
seg033:088F 1E      push ds
seg033:0890 68 22 44 push offset aTrupcRequiresA ;
    "This Software Requires a Software Lock\n"
seg033:0893 1E      push ds
seg033:0894 68 60 E9 push offset byte_6C7E0 ; dest
seg033:0897 9A 79 65 00+ call _strcpy
seg033:089C 83 C4 08 add sp, 8
seg033:089F 1E      push ds
seg033:08A0 68 42 44 push offset aPleaseContactA ; "Please Contact ..."
seg033:08A3 1E      push ds
seg033:08A4 68 60 E9 push offset byte_6C7E0 ; dest
seg033:08A7 9A CD 64 00+ call _strcat
```

Bypassing the dongle is easy, just force the `check_dongle()` function to always return 0.

For example, by inserting this code at its beginning:

```
mov ax,0
retf
```

The observant reader might recall that the `strcpy()` C function usually requires two pointers in its arguments, but we see that 4 values are passed:

```
seg033:088F 1E      push ds
seg033:0890 68 22 44 push offset aTrupcRequiresA ;
    "This Software Requires a Software Lock\n"
seg033:0893 1E      push ds
seg033:0894 68 60 E9 push offset byte_6C7E0 ; dest
seg033:0897 9A 79 65 00+ call _strcpy
seg033:089C 83 C4 08 add sp, 8
```

This is related to MS-DOS' memory model. You can read more about it here: [11.6 on page 1000](#).

So as you may see, `strcpy()` and any other function that take pointer(s) in arguments work with 16-bit pairs.

Let's get back to our example. DS is currently set to the data segment located in the executable, that is where the text string is stored.

In the `sent_pro()` function, each byte of the string is loaded at `seg030:00EF`: the LES instruction loads the ES:BX pair simultaneously from the passed argument.

The MOV at `seg030:00F5` loads the byte from the memory at which the ES:BX pair points.

## 8.9 Encrypted database case #1

(This part has been first appeared in my blog at 26-Aug-2015. Some discussion: <https://news.ycombinator.com/item?id=10128684>.)

### 8.9.1 Base64 and entropy

I've got the XML file containing some encrypted data. Perhaps, it's related to some orders and/or customers information.

```
<?xml version = "1.0" encoding = "UTF-8"?>
<Orders>
  <Order>
    <OrderID>1</OrderID>
```

```

    <Data>yjmxhXUbhB/5MV45chPsXZWAJwIh1S0aD9lFn3XuJMSxJ3/E+UE3hsnH</Data>
  </Order>
  <Order>
    <OrderID>2</OrderID>
    <Data>0KGe/wnypFBjsy+U0C2P9fC5nDZP3XDZLMPCRaiBw90jIk6Tu5U=</Data>
  </Order>
  <Order>
    <OrderID>3</OrderID>
    <Data>mqkXfdzvQKvEArdzh+zD9oETVGBFvcTBLs2ph1b5bYddExzp</Data>
  </Order>
  <Order>
    <OrderID>4</OrderID>
    <Data>FCx6JhIDqnESyT3HAepyE1BJ3cJd7wCk+APCRUeuNtZdpCvQ2MR/7kLXtfUHUA==</Data>
  </Order>
  ...

```

The file is available [here](#).

This is clearly base64-encoded data, because all strings consisting of Latin characters, digits, plus (+) and slash (/) symbols. There can be 1 or 2 padding symbols (=), but they are never occurred in the middle of string. Keeping in mind these base64 properties, it's very easy to recognize them.

Let's decode them and calculate entropies ( [9.2 on page 944](#)) of these blocks in Wolfram Mathematica:

```

In[ ]:= ListOfBase64Strings =
  Map[First#[[3]] &, Cases[Import["encrypted.xml"], XMLElement["Data", _, _], Infinity]];

In[ ]:= BinaryStrings =
  Map[ImportString[#, {"Base64", "String"}] &, ListOfBase64Strings];

In[ ]:= Entropies = Map[N[Entropy[2, #]] &, BinaryStrings];

In[ ]:= Variance[Entropies]
Out[ ]= 0.0238614

```

Variance is low. This means the entropy values are not very different from each other. This is visible on graph:

```

In[ ]:= ListPlot[Entropies]

```

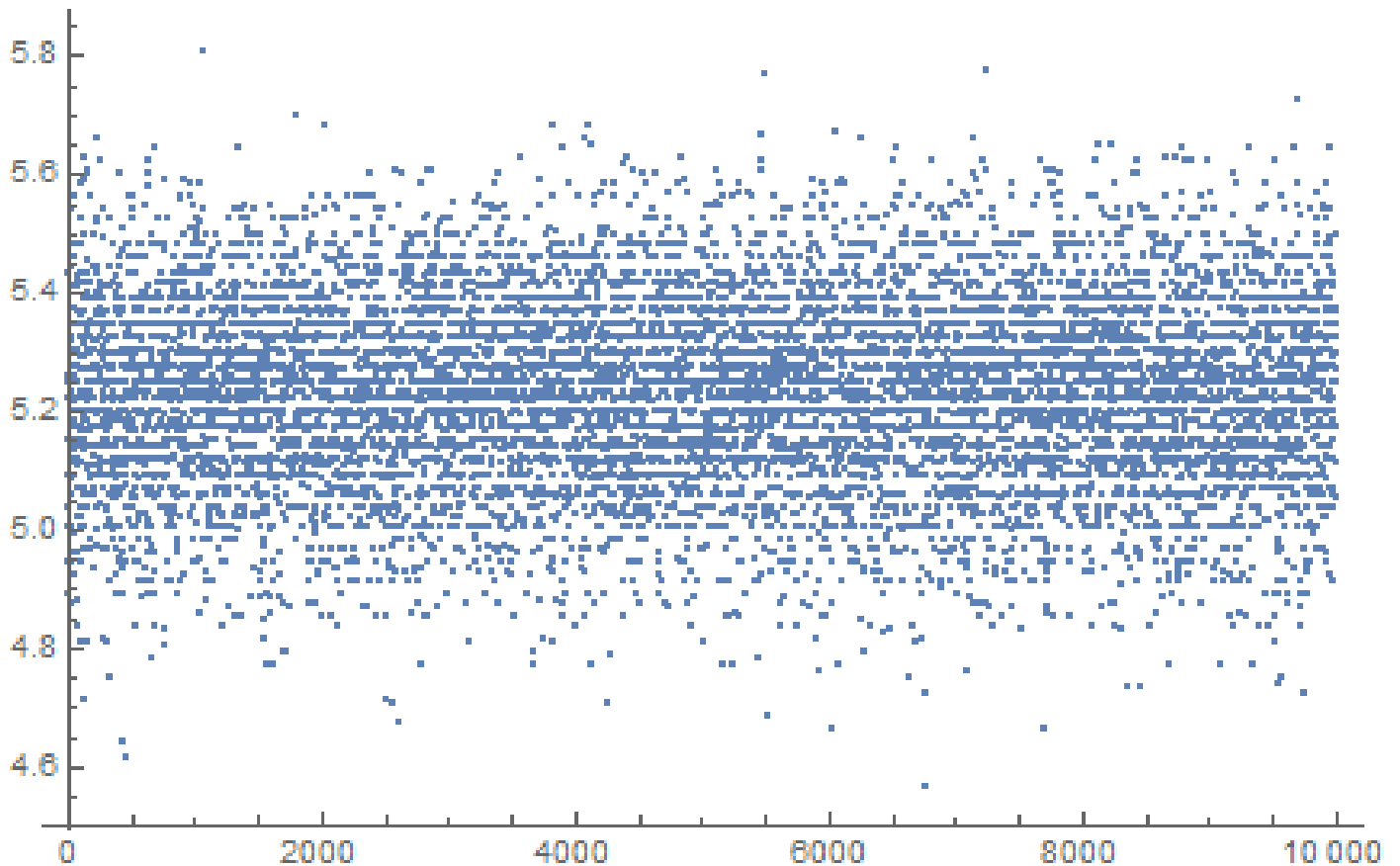

Most values are between 5.0 and 5.4. This is a sign that the data is compressed and/or encrypted.

To understand variance, let's calculate entropies of all lines in Conan Doyle's *The Hound of the Baskervilles* book:

```
In[]:= BaskervillesLines = Import["http://www.gutenberg.org/cache/epub/2852/pg2852.txt", "List↵"];
In[]:= EntropiesT = Map[N[Entropy[2, #]] &, BaskervillesLines];
In[]:= Variance[EntropiesT]
Out[]:= 2.73883
In[]:= ListPlot[EntropiesT]
```

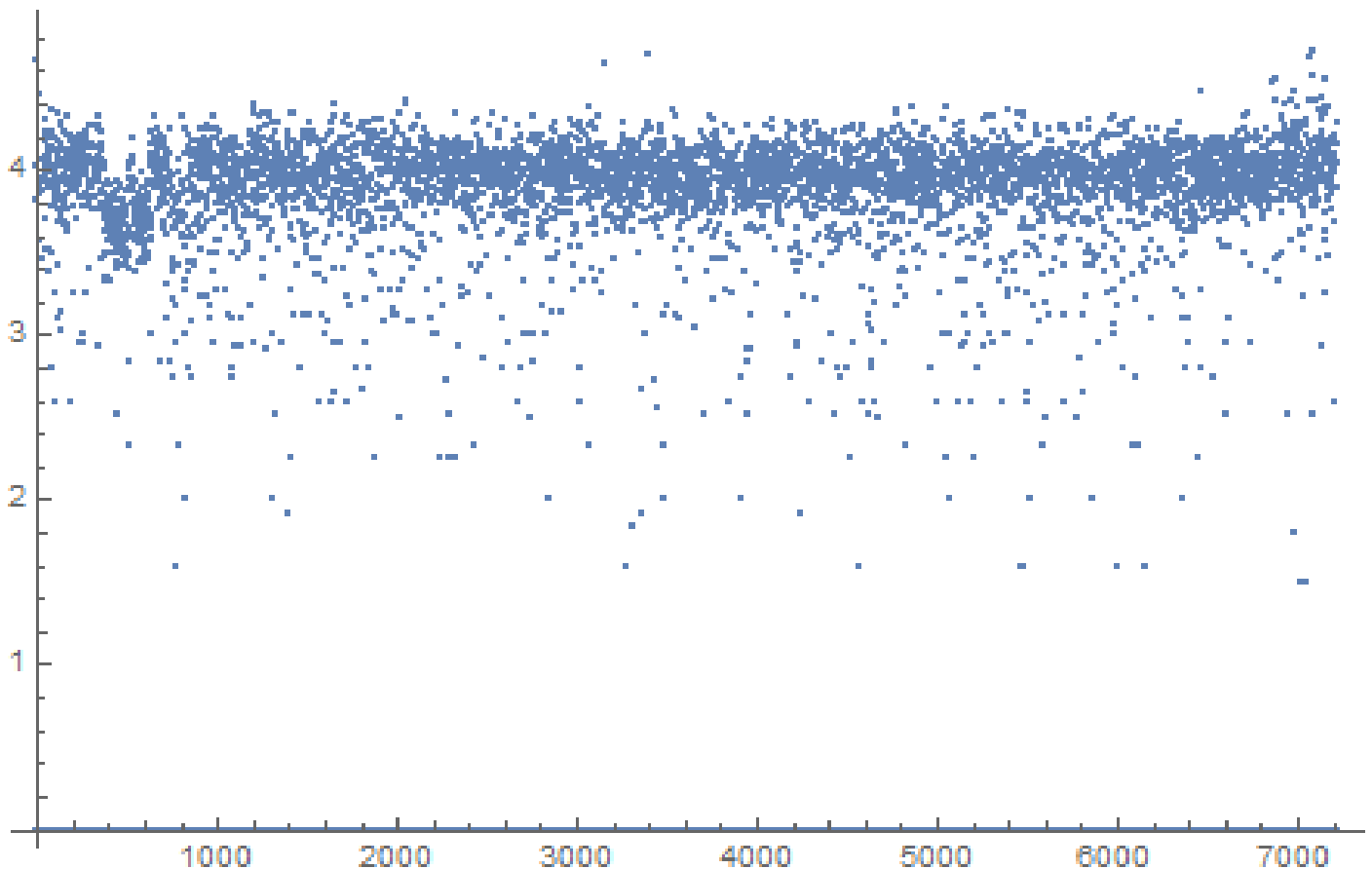

Most values are gathered around value of 4, but there are also values which are smaller, and they are influenced final variance value.

Perhaps, shortest strings has smaller entropy, let's take short string from the Conan Doyle's book:

```
In[]:= Entropy[2, "Yes, sir."] // N
Out[]= 2.9477
```

Let's try even shorter:

```
In[]:= Entropy[2, "Yes"] // N
Out[]= 1.58496
```

```
In[]:= Entropy[2, "No"] // N
Out[]= 1.
```

## 8.9.2 Is data compressed?

OK, so our data is compressed and/or encrypted. Is it compressed? Almost all data compressors put some header at the start, signature, or something like that. As we can see, there are no consistent data at the start of each block. It's still possible that this is a handmade data compressor, but they are very rare. On the other hand, handmade cryptoalgorithms are much more popular, because it's very easy to make it work. Even primitive keyless cryptosystems like *memfrob()*<sup>19</sup> and ROT13 works fine without errors. It's a serious challenge to write data compressor from scratch using only fantasy and imagination in a way so it will have no evident bugs. Some programmers implements data compression functions by reading textbooks, but this is also rare. The most popular two ways are: 1) just take open-source library like zlib; 2) copy&paste something from somewhere. Open-source data compressions algorithms usually puts some kind of header, and so do algorithms from sites like <http://www.codeproject.com/>.

<sup>19</sup><http://linux.die.net/man/3/memfrob>



### 8.9.3 Is data encrypted?

Major data encryption algorithms process data in blocks. DES—8 bytes, AES—16 bytes. If the input buffer is not divided evenly by block size, it's padded by zeroes (or something else), so encrypted data will be aligned by cryptoalgorithm's block size. This is not our case.

Using Wolfram Mathematica, I analyzed block's lengths:

```
In[ ]:= Counts[Map[StringLength[#] &, BinaryStrings]]
Out[ ]= <|42 -> 1858, 38 -> 1235, 36 -> 699, 46 -> 1151, 40 -> 1784,
 44 -> 1558, 50 -> 366, 34 -> 291, 32 -> 74, 56 -> 15, 48 -> 716,
 30 -> 13, 52 -> 156, 54 -> 71, 60 -> 3, 58 -> 6, 28 -> 4|>
```

1858 blocks has size of 42 bytes, 1235 blocks has size of 38 bytes, etc.

I made a graph:

```
ListPlot[Counts[Map[StringLength[#] &, BinaryStrings]]]
```

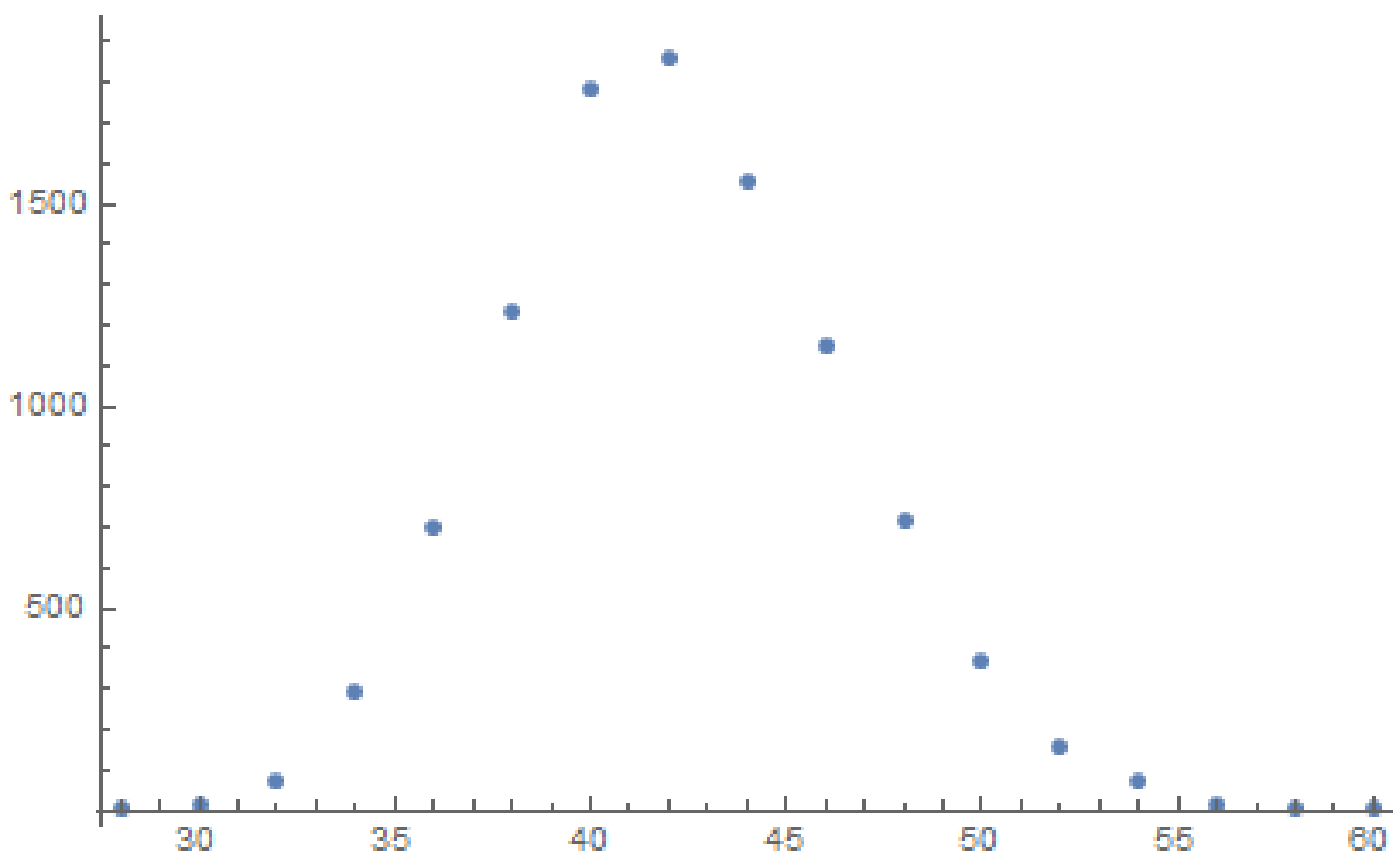

So, most blocks has size between ~36 and ~48. There is also another thing to notice: all block sizes are even. No single block with odd size.

There are, however, stream ciphers which can operate on byte level or even on bit level.

### 8.9.4 CryptoPP

The program which can browse this encrypted database is written C# and the .NET code is heavily obfuscated. Nevertheless, there is DLL with x86 code, which, after brief examination, has parts of the CryptoPP popular open-source library! (I just spotted "CryptoPP" strings inside.) Now it's very easy to find all functions inside of DLL because CryptoPP library is open-source.

CryptoPP library has a lot of crypto-functions, including AES (AKA Rijndael). Newer x86 CPUs has AES helper instructions like AESENC, AESDEC and AESKEYGENASSIST<sup>20</sup>. They are not performing encryption/decryption completely, but they do significant amount of job. And newer CryptoPP versions use them. For

<sup>20</sup>[https://en.wikipedia.org/wiki/AES\\_instruction\\_set](https://en.wikipedia.org/wiki/AES_instruction_set)

example, here: 1, 2. To my surprise, during decryption, AESENC gets executed, while AESDEC is not (I just checked with my tracer utility, but any debugger can be used). I checked, if my CPU really supports AES instructions. Some Intel i3 CPUs are not. And if not, CryptoPP library falling back to AES functions implemented in old way<sup>21</sup>. But my CPU supports them. Why AESDEC is still not executed? Why the program use AES encryption in order to decrypt database?

OK, it's not a problem to find a function which encrypts block. It is called `CryptoPP::Rijndael::Enc::ProcessAndXorBlock`: `src`, and it can call another function: `Rijndael::Enc::AdvancedProcessBlocks()` `src`, which, in turn, can call two other functions ( `AESNI_Enc_Block` and `AESNI_Enc_4_Blocks` ) which has AESENC instructions.

So, judging by CryptoPP internals, `CryptoPP::Rijndael::Enc::ProcessAndXorBlock()` encrypts one 16-byte block. Let's set breakpoint on it and see, what happens during decryption. I use my simple tracer tool again. The software must decrypt first data block now. Oh, by the way, here is the first data block converted from base64 encoding to hexadecimal data, let's have it at hand:

```
00000000: CA 39 B1 85 75 1B 84 1F F9 31 5E 39 72 13 EC 5D .9..u....1^9r..]
00000010: 95 80 27 02 21 D5 2D 1A 0F D9 45 9F 75 EE 24 C4 ..'.!.-...E.u.$
00000020: B1 27 7F 84 FE 41 37 86 C9 C0                .'...A7...
```

These are also arguments of the function from CryptoPP source files:

```
size_t Rijndael::Enc::AdvancedProcessBlocks(const byte *inBlocks, const byte *xorBlocks, byte *outBlocks, size_t length, word32 flags);
```

So it has 5 arguments. Possible flags are:

```
enum {BT_InBlockIsCounter=1, BT_DontIncrementInOutPointers=2, BT_XorInput=4, BT_ReverseDirection=8, BT_AllowParallel=16} FlagsForAdvancedProcessBlocks;
```

OK, run tracer on `ProcessAndXorBlock()` function:

```
... tracer.exe -l:filename.exe bpf=filename.exe!0x4339a0,args:5,dump_args:0x10
Warning: no tracer.cfg file.
PID=1984|New process software.exe
no module registered with image base 0x77320000
no module registered with image base 0x76e20000
no module registered with image base 0x77320000
no module registered with image base 0x77220000
Warning: unknown (to us) INT3 breakpoint at ntdll.dll!LdrVerifyImageMatchesChecksum+0x96c (0x776c103b)
(0) software.exe!0x4339a0(0x38b920, 0x0, 0x38b978, 0x10, 0x0) (called from software.exe!.text+0x33c0d (0x13e4c0d))
Argument 1/5
0038B920: 01 00 00 00 FF FF FF FF-79 C1 69 0B 67 C1 04 7D ".....y.i.g..}"
Argument 3/5
0038B978: CD CD CD CD CD CD CD CD-CD CD CD CD CD CD CD "....."
(0) software.exe!0x4339a0() -> 0x0
Argument 3/5 difference
00000000: C7 39 4E 7B 33 1B D6 1F-B8 31 10 39 39 13 A5 5D ".9N{3....1.99..}"
(0) software.exe!0x4339a0(0x38a828, 0x38a838, 0x38bb40, 0x0, 0x8) (called from software.exe!.text+0x3a407 (0x13eb407))
Argument 1/5
0038A828: 95 80 27 02 21 D5 2D 1A-0F D9 45 9F 75 EE 24 C4 "..'.!.-...E.u.$."
Argument 2/5
0038A838: B1 27 7F 84 FE 41 37 86-C9 C0 00 CD CD CD CD CD ".'...A7....."
Argument 3/5
0038BB40: CD CD CD CD CD CD CD CD-CD CD CD CD CD CD CD "....."
(0) software.exe!0x4339a0() -> 0x0
(0) software.exe!0x4339a0(0x38b920, 0x38a828, 0x38bb30, 0x10, 0x0) (called from software.exe!.text+0x33c0d (0x13e4c0d))
Argument 1/5
0038B920: CA 39 B1 85 75 1B 84 1F-F9 31 5E 39 72 13 EC 5D ".9..u....1^9r..]"
```

<sup>21</sup><https://github.com/moss/cryptopp/blob/2772f7b57182b31a41659b48d5f35a7b6cedd34d/src/rijndael.cpp#L355>

```

Argument 2/5
0038A828: 95 80 27 02 21 D5 2D 1A-0F D9 45 9F 75 EE 24 C4 "...!.!-...E.u.$."
Argument 3/5
0038BB30: CD CD CD CD CD CD CD CD-CD CD CD CD CD CD CD CD "....."
(0) software.exe!0x4339a0() -> 0x0
Argument 3/5 difference
00000000: 45 00 20 00 4A 00 4F 00-48 00 4E 00 53 00 00 00 "E. .J.O.H.N.S..."
(0) software.exe!0x4339a0(0x38b920, 0x0, 0x38b978, 0x10, 0x0) (called from software.exe!.text+0x
↳ x33c0d (0x13e4c0d))
Argument 1/5
0038B920: 95 80 27 02 21 D5 2D 1A-0F D9 45 9F 75 EE 24 C4 "...!.!-...E.u.$."
Argument 3/5
0038B978: 95 80 27 02 21 D5 2D 1A-0F D9 45 9F 75 EE 24 C4 "...!.!-...E.u.$."
(0) software.exe!0x4339a0() -> 0x0
Argument 3/5 difference
00000000: B1 27 7F E4 9F 01 E3 81-CF C6 12 FB B9 7C F1 BC ".!.....|.."
PID=1984|Process software.exe exited. ExitCode=0 (0x0)

```

Here we can see inputs to the *ProcessAndXorBlock()* function, and outputs from it.

This is output from the function during first call:

```
00000000: C7 39 4E 7B 33 1B D6 1F-B8 31 10 39 39 13 A5 5D ".9N{3...1.99..]"
```

Then the *ProcessAndXorBlock()* is called with zero-length block, but with 8 flag (*BT\_ReverseDirection*).

Second call:

```
00000000: 45 00 20 00 4A 00 4F 00-48 00 4E 00 53 00 00 00 "E. .J.O.H.N.S..."
```

Wow, there is some string familiar to us!

Third call:

```
00000000: B1 27 7F E4 9F 01 E3 81-CF C6 12 FB B9 7C F1 BC ".!.....|.."
```

The first output is very similar to the first 16 bytes of the encrypted buffer.

Output of the first call of *ProcessAndXorBlock()*:

```
00000000: C7 39 4E 7B 33 1B D6 1F-B8 31 10 39 39 13 A5 5D ".9N{3...1.99..]"
```

First 16 bytes of encrypted buffer:

```
00000000: CA 39 B1 85 75 1B 84 1F F9 31 5E 39 72 13 EC 5D ".9..u....1^9r..]"
```

There are too much equal bytes! How come AES encryption result can be very similar to the encrypted buffer while this is not encryption but rather decryption?!

### 8.9.5 Cipher Feedback mode

The answer is [CFB<sup>22</sup>](#): in this mode, AES algorithm used not as encryption algorithm, but as a device which generates cryptographically secure random data. The actual encryption is happening using simple XOR operation.

Here is encryption algorithm (images are taken from Wikipedia):

<sup>22</sup>Cipher Feedback

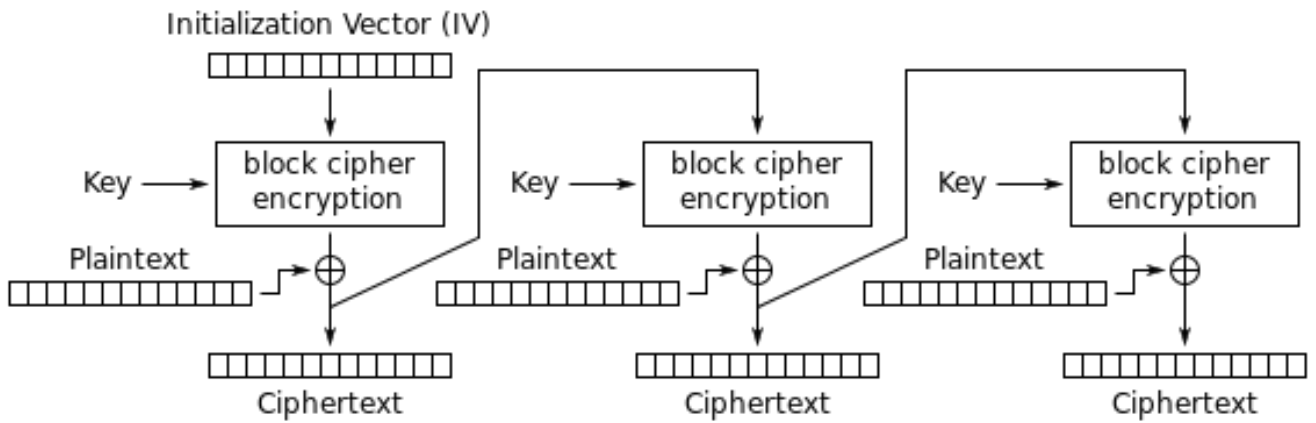

Cipher Feedback (CFB) mode encryption

And decryption:

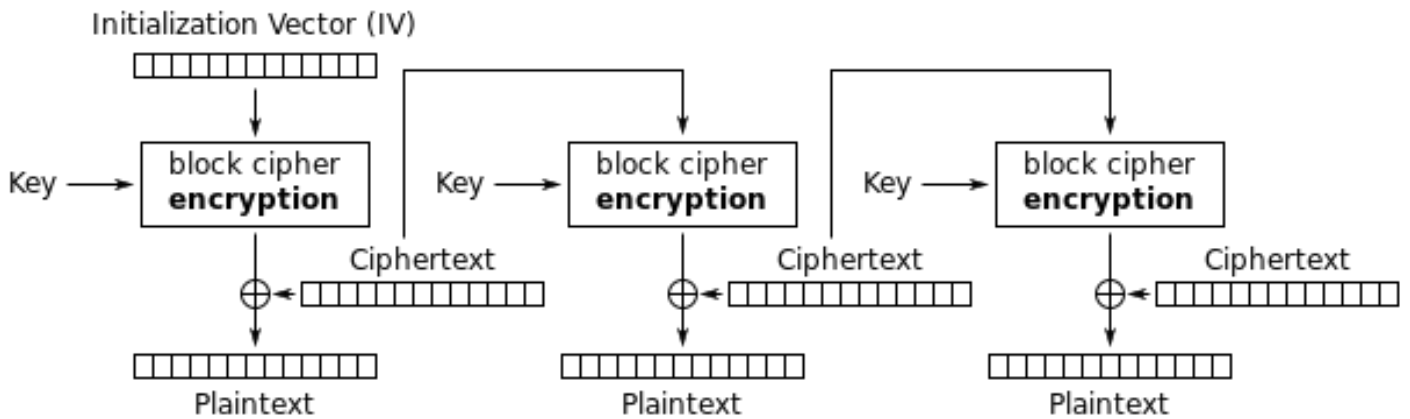

Cipher Feedback (CFB) mode decryption

Now let's see: AES encryption operation generates 16 bytes (or 128 bits) of *random* data to be used while XOR-ing, who forces us to use all 16 bytes? If at the last iteration we've got 1 byte of data, let's xor 1 byte of data with 1 byte of generated *random* data? This leads to important property of CFB mode: data can be not padded, data of arbitrary size can be encrypted and decrypted.

Oh, that's why all encrypted blocks are not padded. And that's why AESDEC instruction is never called.

Let's try to decrypt first block manually, using Python. CFB mode also use IV, as a seed for CSPRNG<sup>23</sup>. In our case, IV is the block which is encrypted at first iteration:

```
0038B920: 01 00 00 00 FF FF FF FF-79 C1 69 0B 67 C1 04 7D ". . . . .y.i.g..}"
```

Oh, and we also have to recover encryption key. There is AESKEYGENASSIST is DLL, and it is called, and it is used in the `Rijndael::Base::UncheckedSetKey()` function: [src](#). It's easy to find it in IDA and set breakpoint. Let's see:

```
... tracer.exe -l:filename.exe bpf=filename.exe!0x435c30,args:3,dump_args:0x10
Warning: no tracer.cfg file.
PID=2068|New process software.exe
```

<sup>23</sup>Cryptographically Secure Pseudorandom Number Generator

```

no module registered with image base 0x77320000
no module registered with image base 0x76e20000
no module registered with image base 0x77320000
no module registered with image base 0x77220000
Warning: unknown (to us) INT3 breakpoint at ntdll.dll!LdrVerifyImageMatchesChecksum+0x96c (0x776c103b)
(0) software.exe!0x435c30(0x15e8000, 0x10, 0x14f808) (called from software.exe!.text+0x22fa1 (0x13d3fa1))
Argument 1/3
015E8000: CD C5 7E AD 28 5F 6D E1-CE 8F CC 29 B1 21 88 8E "...~.( _m....)!..."
Argument 3/3
0014F808: 38 82 58 01 C8 B9 46 00-01 D1 3C 01 00 F8 14 00 "8.X...F...<....."
Argument 3/3 +0x0: software.exe!.rdata+0x5238
Argument 3/3 +0x8: software.exe!.text+0x1c101
(0) software.exe!0x435c30() -> 0x13c2801
PID=2068|Process software.exe exited. ExitCode=0 (0x0)

```

So this is the key: *CD C5 7E AD 28 5F 6D E1-CE 8F CC 29 B1 21 88 8E*.

During manual decryption we've got this:

```

00000000: 0D 00 FF FE 46 00 52 00 41 00 4E 00 4B 00 49 00 ....F.R.A.N.K.I.
00000010: 45 00 20 00 4A 00 4F 00 48 00 4E 00 53 00 66 66 E. .J.O.H.N.S.ff
00000020: 66 66 66 9E 61 40 D4 07 06 01 fff.a@....

```

Now this is something readable! And now we can see why there were so many equal bytes at the first decryption iteration: because plaintext has so many zero bytes!

Let's decrypt the second block:

```

00000000: 17 98 D0 84 3A E9 72 4F DB 82 3F AD E9 3E 2A A8 .....r0...?..>*.
00000010: 41 00 52 00 52 00 4F 00 4E 00 CD CC CC CC CC CC A.R.R.O.N.....
00000020: 1B 40 D4 07 06 01 .@....

```

Third, fourth and fifth:

```

00000000: 5D 90 59 06 EF F4 96 B4 7C 33 A7 4A BE FF 66 AB ].Y.....|3.J..f.
00000010: 49 00 47 00 47 00 53 00 00 00 00 00 00 C0 65 40 I.G.G.S.....e@
00000020: D4 07 06 01 ....

```

```

00000000: D3 15 34 5D 21 18 7C 6E AA F8 2D FE 38 F9 D7 4E ..4]!.|n...-8..N
00000010: 41 00 20 00 44 00 4F 00 48 00 45 00 52 00 54 00 A. .D.O.H.E.R.T.
00000020: 59 00 48 E1 7A 14 AE FF 68 40 D4 07 06 02 Y.H.z...h@....

```

```

00000000: 1E 8B 90 0A 17 7B C5 52 31 6C 4E 2F DE 1B 27 19 .....{.R11N...'.
00000010: 41 00 52 00 43 00 55 00 53 00 00 00 00 00 60 A.R.C.U.S.....
00000020: 66 40 D4 07 06 03 f@....

```

All blocks decrypted seems correct except of first 16 bytes part.

## 8.9.6 Initializing Vector

What can affect first 16 bytes?

Let's back to [CFB](#) decryption algorithm again: [8.9.5 on the previous page](#).

We can see that **IV** can affect to first block decryption operation, but not the second, because during the second iteration, ciphertext from the first iteration is used, and in case of decryption, it's the same, no matter what **IV** has!

So probably, **IV** is different each time. Using my tracer, I'll take a look at the first input during decryption of the second block of **XML** file:

```
0038B920: 02 00 00 00 FE FF FF FF-79 C1 69 0B 67 C1 04 7D ".....y.i.g..}"
```

...third:

```
0038B920: 03 00 00 00 FD FF FF FF-79 C1 69 0B 67 C1 04 7D ".....y.i.g..}"
```

It seems, first and fifth byte are changed each time. I finally concluded that the first 32-bit integer is just OrderID from the **XML** file, and the second 32-bit integer is also OrderID, but negated. All other 8 bytes are same for each operation. Now I have decrypted the whole database: [https://beginners.re/current-tree/examples/encrypted\\_DB1/decrypted.full.txt](https://beginners.re/current-tree/examples/encrypted_DB1/decrypted.full.txt).

The Python script used for this is: [https://beginners.re/current-tree/examples/encrypted\\_DB1/decrypt\\_blocks.py](https://beginners.re/current-tree/examples/encrypted_DB1/decrypt_blocks.py).

Perhaps, the author wanted each block encrypted differently, so he/she used OrderID as part of key. It would be also possible to make different AES key instead of **IV**.

So now we know that **IV** only affects first block during decryption in **CFB** mode, this is feature of it. All other blocks can be decrypted without knowledge **IV**, but using the key.

OK, so why **CFB** mode? Apparently, because the very first AES example on CryptoPP wiki uses **CFB** mode: [http://www.cryptopp.com/wiki/Advanced\\_Encryption\\_Standard#Encrypting\\_and\\_Decrypting\\_Using\\_AES](http://www.cryptopp.com/wiki/Advanced_Encryption_Standard#Encrypting_and_Decrypting_Using_AES). Supposedly, developer choose it for simplicity: the example can encrypt/decrypt text strings with arbitrary lengths, without padding.

It is very likely, program's author(s) just cypasted the example from CryptoPP wiki page. Many programmers do so.

The only difference that **IV** is chosen randomly in CryptoPP wiki example, while this indeterminism wasn't allowable to programmers of the software we are dissecting now, so they choose to initialize **IV** using Order ID.

Now we can proceed to analyzing matter of each byte in the decrypted block.

### 8.9.7 Structure of the buffer

Let's take first four decrypted blocks:

```
00000000: 0D 00 FF FE 46 00 52 00 41 00 4E 00 4B 00 49 00 ....F.R.A.N.K.I.
00000010: 45 00 20 00 4A 00 4F 00 48 00 4E 00 53 00 66 66 E. .J.O.H.N.S. ff
00000020: 66 66 66 9E 61 40 D4 07 06 01 fff.a@....

00000000: 0B 00 FF FE 4C 00 4F 00 52 00 49 00 20 00 42 00 ....L.O.R.I. .B.
00000010: 41 00 52 00 52 00 4F 00 4E 00 CD CC CC CC CC CC A.R.R.O.N.....
00000020: 1B 40 D4 07 06 01 .@....

00000000: 0A 00 FF FE 47 00 41 00 52 00 59 00 20 00 42 00 ....G.A.R.Y. .B.
00000010: 49 00 47 00 47 00 53 00 00 00 00 00 00 C0 65 40 I.G.G.S.....e@
00000020: D4 07 06 01 ....

00000000: 0F 00 FF FE 4D 00 45 00 4C 00 49 00 4E 00 44 00 ....M.E.L.I.N.D.
00000010: 41 00 20 00 44 00 4F 00 48 00 45 00 52 00 54 00 A. .D.O.H.E.R.T.
00000020: 59 00 48 E1 7A 14 AE FF 68 40 D4 07 06 02 Y.H.z...h@....
```

UTF-16 encoded text strings are clearly visible, these are names and surnames. The first byte (or 16-bit word) is seems string length, we can visually check it. **FF FE** is seems Unicode **BOM**.

There are 12 more bytes after each string.

Using this script ([https://beginners.re/current-tree/examples/encrypted\\_DB1/dump\\_buffer\\_rest.py](https://beginners.re/current-tree/examples/encrypted_DB1/dump_buffer_rest.py)) I've got random selection of the *tails*:

```
dennis@...:$ python decrypt.py encrypted.xml | shuf | head -20
00000000: 48 E1 7A 14 AE 5F 62 40 DD 07 05 08 H.z..._b@....
00000000: 00 00 00 00 00 40 5A 40 DC 07 08 18 .....@Z@....
00000000: 00 00 00 00 00 80 56 40 D7 07 0B 04 .....V@....
00000000: 00 00 00 00 00 60 61 40 D7 07 0C 1C .....a@....
00000000: 00 00 00 00 00 20 63 40 D9 07 05 18 .....c@....
00000000: 3D 0A D7 A3 70 FD 34 40 D7 07 07 11 =...p.4@....
00000000: 00 00 00 00 00 A0 63 40 D5 07 05 19 .....c@....
00000000: CD CC CC CC CC 3C 5C 40 D7 07 08 11 .....@....
00000000: 66 66 66 66 66 FE 62 40 D4 07 06 05 fffff.b@....
00000000: 1F 85 EB 51 B8 FE 40 40 D6 07 09 1E ...Q..@@....
00000000: 00 00 00 00 00 40 5F 40 DC 07 02 18 .....@_@....
00000000: 48 E1 7A 14 AE 9F 67 40 D8 07 05 12 H.z...g@....
00000000: CD CC CC CC CC 3C 5E 40 DC 07 01 07 .....^@....
00000000: 00 00 00 00 00 00 67 40 D4 07 0B 0E .....g@....
00000000: 00 00 00 00 00 40 51 40 DC 07 04 0B .....@Q@....
00000000: 00 00 00 00 00 40 56 40 D7 07 07 0A .....@V@....
00000000: 8F C2 F5 28 5C 7F 55 40 DB 07 01 16 ...(..U@....
00000000: 00 00 00 00 00 00 32 40 DB 07 06 09 .....2@....
00000000: 66 66 66 66 66 7E 66 40 D9 07 0A 06 fffff~f@....
00000000: 48 E1 7A 14 AE DF 68 40 D5 07 07 16 H.z...h@....
```

We first see the 0x40 and 0x07 bytes present in each *tail*. The very last byte s always in 1..0x1F (1..31) range, I've checked. The penultimate byte is always in 1..0xC (1..12) range. Wow, that looks like a date! Year can be represented as 16-bit value, and maybe last 4 bytes is date (16 bits for year, 8 bits for month and 8 more for day)? 0x7DD is 2013, 0x7D5 is 2005, etc. Seems fine. This is a date. There are 8 more bytes. Judging by the fact this is database named *orders*, maybe some kind of sum is present here? I made attempt to interpret it as double-precision IEEE 754 floating point and dump all values!

Some are:

```
71.0
134.0
51.95
53.0
121.99
96.95
98.95
15.95
85.95
184.99
94.95
29.95
85.0
36.0
130.99
115.95
87.99
127.95
114.0
150.95
```

Looks like real!

Now we can dump names, sums and dates.

```
plain:
00000000: 0D 00 FF FE 46 00 52 00 41 00 4E 00 4B 00 49 00 ....F.R.A.N.K.I.
00000010: 45 00 20 00 4A 00 4F 00 48 00 4E 00 53 00 66 66 E. .J.O.H.N.S.ff
00000020: 66 66 66 9E 61 40 D4 07 06 01 fff.a@....
OrderID= 1 name= FRANKIE JOHNS sum= 140.95 date= 2004 / 6 / 1

plain:
00000000: 0B 00 FF FE 4C 00 4F 00 52 00 49 00 20 00 42 00 ....L.O.R.I. .B.
00000010: 41 00 52 00 52 00 4F 00 4E 00 CD CC CC CC CC CC A.R.R.O.N.....
00000020: 1B 40 D4 07 06 01 .@....
```

```
OrderID= 2 name= LORI BARRON sum= 6.95 date= 2004 / 6 / 1
```

```
plain:
```

```
00000000: 0A 00 FF FE 47 00 41 00 52 00 59 00 20 00 42 00 ....G.A.R.Y. .B.  
00000010: 49 00 47 00 47 00 53 00 00 00 00 00 00 C0 65 40 I.G.G.S.....e@  
00000020: D4 07 06 01 .....  
OrderID= 3 name= GARY BIGGS sum= 174.0 date= 2004 / 6 / 1
```

```
plain:
```

```
00000000: 0F 00 FF FE 4D 00 45 00 4C 00 49 00 4E 00 44 00 ....M.E.L.I.N.D.  
00000010: 41 00 20 00 44 00 4F 00 48 00 45 00 52 00 54 00 A. .D.O.H.E.R.T.  
00000020: 59 00 48 E1 7A 14 AE FF 68 40 D4 07 06 02 Y.H.z...h@....  
OrderID= 4 name= MELINDA DOHERTY sum= 199.99 date= 2004 / 6 / 2
```

```
plain:
```

```
00000000: 0B 00 FF FE 4C 00 45 00 4E 00 41 00 20 00 4D 00 ....L.E.N.A. .M.  
00000010: 41 00 52 00 43 00 55 00 53 00 00 00 00 00 60 A.R.C.U.S.....  
00000020: 66 40 D4 07 06 03 f@....  
OrderID= 5 name= LENA MARCUS sum= 179.0 date= 2004 / 6 / 3
```

See more: [https://beginners.re/current-tree/examples/encrypted\\_DB1/decrypted.full.with\\_data.txt](https://beginners.re/current-tree/examples/encrypted_DB1/decrypted.full.with_data.txt). Or filtered: [https://beginners.re/current-tree/examples/encrypted\\_DB1/decrypted.short.txt](https://beginners.re/current-tree/examples/encrypted_DB1/decrypted.short.txt). Seems correct.

This is some kind of **OOP** serialization, i.e., packing differently typed values into binary buffer for storing and/or transmitting.

## 8.9.8 Noise at the end

The only question remaining is that sometimes, *tail* is bigger:

```
00000000: 0E 00 FF FE 54 00 48 00 45 00 52 00 45 00 53 00 ....T.H.E.R.E.S.  
00000010: 45 00 20 00 54 00 55 00 54 00 54 00 4C 00 45 00 E. .T.U.T.T.L.E.  
00000020: 66 66 66 66 66 1E 63 40 D4 07 07 1A 00 07 07 19 fffff.c@.....  
OrderID= 172 name= THERESE TUTTLE sum= 152.95 date= 2004 / 7 / 26
```

(00 07 07 19 bytes are not used and is ballast.)

```
00000000: 0C 00 FF FE 4D 00 45 00 4C 00 41 00 4E 00 49 00 ....M.E.L.A.N.I.  
00000010: 45 00 20 00 4B 00 49 00 52 00 4B 00 00 00 00 00 E. .K.I.R.K.....  
00000020: 00 20 64 40 D4 07 09 02 00 02 . d@.....  
OrderID= 286 name= MELANIE KIRK sum= 161.0 date= 2004 / 9 / 2
```

(00 02 are not used.)

After close examination, we can see, that the noise at the end of *tail* is just left from previous encryption!

Here are two subsequent buffers:

```
00000000: 10 00 FF FE 42 00 4F 00 4E 00 4E 00 49 00 45 00 ....B.O.N.N.I.E.  
00000010: 20 00 47 00 4F 00 4C 00 44 00 53 00 54 00 45 00 .G.O.L.D.S.T.E.  
00000020: 49 00 4E 00 9A 99 99 99 99 79 46 40 D4 07 07 19 I.N.....yF@....  
OrderID= 171 name= BONNIE GOLDSTEIN sum= 44.95 date= 2004 / 7 / 25
```

```
00000000: 0E 00 FF FE 54 00 48 00 45 00 52 00 45 00 53 00 ....T.H.E.R.E.S.  
00000010: 45 00 20 00 54 00 55 00 54 00 54 00 4C 00 45 00 E. .T.U.T.T.L.E.  
00000020: 66 66 66 66 66 1E 63 40 D4 07 07 1A 00 07 07 19 fffff.c@.....  
OrderID= 172 name= THERESE TUTTLE sum= 152.95 date= 2004 / 7 / 26
```

(The last 07 07 19 bytes are copied from the previous plaintext buffer.)

Another two subsequent buffers:



```

00000000: 0D 00 FF FE 4C 00 4F 00 52 00 45 00 4E 00 45 00  ....L.O.R.E.N.E.
00000010: 20 00 4F 00 54 00 4F 00 4F 00 4C 00 45 00 CD CC  .O.T.O.O.L.E...
00000020: CC CC CC 3C 5E 40 D4 07 09 02  ...<^@....
OrderID= 285 name= LORENE OT00LE sum= 120.95 date= 2004 / 9 / 2

00000000: 0C 00 FF FE 4D 00 45 00 4C 00 41 00 4E 00 49 00  ....M.E.L.A.N.I.
00000010: 45 00 20 00 4B 00 49 00 52 00 4B 00 00 00 00 00  E. .K.I.R.K.....
00000020: 00 20 64 40 D4 07 09 02 00 02  . d@.....
OrderID= 286 name= MELANIE KIRK sum= 161.0 date= 2004 / 9 / 2

```

The last 02 byte has been copied from the previous plaintext buffer.

It's possible if the buffer used while encrypting is global and/or isn't clearing before each encryption. The final buffer size is also chaotic, nevertheless, the bug left uncaught because it doesn't affect decrypting process, which just ignores noise at the end. This is common mistake. It's been present in OpenSSL (Heartbleed bug).

### 8.9.9 Conclusion

Summary: every practicing reverse engineer should be familiar with major crypto algorithms and also major cryptographical modes. Some books about it: [12.1.10 on page 1015](#).

*Encrypted* database contents has been artificially constructed by me for the sake of demonstration. I've got most popular USA names and surnames from there: <http://stackoverflow.com/questions/1803628/raw-list-of-person-names>, and combined them randomly. Dates and sums were also generated randomly.

All files used in this part are here: [https://beginners.re/current-tree/examples/encrypted\\_DB1](https://beginners.re/current-tree/examples/encrypted_DB1).

Nevertheless, many features like these I've observed in real-world software applications. This example is based on them.

### 8.9.10 Post Scriptum: brute-forcing IV

The case you have just seen has been artificially constructed, but is based on a real application I've reverse engineered. When I've been working on it, I first noticed that **IV** has been generating using some 32-bit number, and I wasn't able to find a link between this value and OrderID. So I prepared to use brute-force, which is indeed possible here.

It's not a problem to enumerate all 32-bit values and try each as a base for **IV**. Then you decrypt the first 16-byte block and check for zero bytes, which are always at fixed places.

## 8.10 Overclocking Cointerra Bitcoin miner

There was Cointerra Bitcoin miner, looking like that:

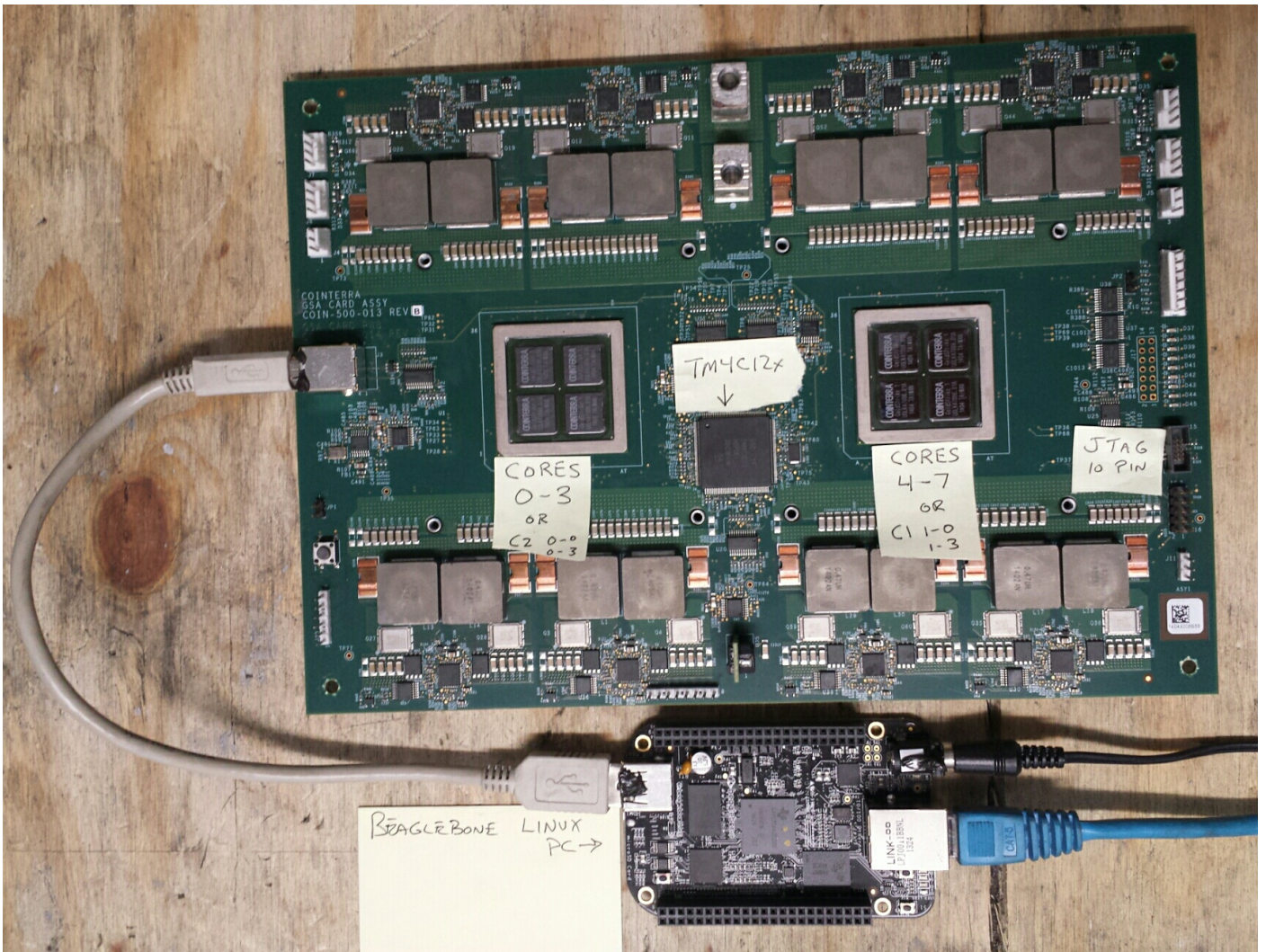

Figure 8.14: Board

And there was also (possibly leaked) utility<sup>24</sup> which can set clock rate for the board. It runs on additional BeagleBone Linux ARM board (small board at bottom of the picture).

And the author was once asked, is it possible to hack this utility to see, which frequency can be set and which are not. And it is possible to tweak it?

The utility must be executed like that: `./cointool-overclock 0 0 900`, where 900 is frequency in MHz. If the frequency is too high, utility will print “Error with arguments” and exit.

This is a fragment of code around reference to “Error with arguments” text string:

```

...

.text:0000ABC4    STR     R3, [R11,#var_28]
.text:0000ABC8    MOV     R3, #optind
.text:0000ABD0    LDR     R3, [R3]
.text:0000ABD4    ADD     R3, R3, #1
.text:0000ABD8    MOV     R3, R3,LSL#2
.text:0000ABDC    LDR     R2, [R11,#argv]
.text:0000ABE0    ADD     R3, R2, R3
.text:0000ABE4    LDR     R3, [R3]
.text:0000ABE8    MOV     R0, R3 ; nptr
.text:0000ABEC    MOV     R1, #0 ; endptr
.text:0000ABF0    MOV     R2, #0 ; base
.text:0000ABF4    BL      strtoll
.text:0000ABF8    MOV     R2, R0

```

<sup>24</sup>Can be downloaded here: [https://beginners.re/current-tree/examples/bitcoin\\_miner/files/cointool-overclock](https://beginners.re/current-tree/examples/bitcoin_miner/files/cointool-overclock)

```

.text:0000ABFC      MOV     R3, R1
.text:0000AC00      MOV     R3, R2
.text:0000AC04      STR     R3, [R11,#var_2C]
.text:0000AC08      MOV     R3, #optind
.text:0000AC10      LDR     R3, [R3]
.text:0000AC14      ADD     R3, R3, #2
.text:0000AC18      MOV     R3, R3,LSL#2
.text:0000AC1C      LDR     R2, [R11,#argv]
.text:0000AC20      ADD     R3, R2, R3
.text:0000AC24      LDR     R3, [R3]
.text:0000AC28      MOV     R0, R3 ; nptr
.text:0000AC2C      MOV     R1, #0 ; endptr
.text:0000AC30      MOV     R2, #0 ; base
.text:0000AC34      BL      strtoll
.text:0000AC38      MOV     R2, R0
.text:0000AC3C      MOV     R3, R1
.text:0000AC40      MOV     R3, R2
.text:0000AC44      STR     R3, [R11,#third_argument]
.text:0000AC48      LDR     R3, [R11,#var_28]
.text:0000AC4C      CMP     R3, #0
.text:0000AC50      BLT     errors_with_arguments
.text:0000AC54      LDR     R3, [R11,#var_28]
.text:0000AC58      CMP     R3, #1
.text:0000AC5C      BGT     errors_with_arguments
.text:0000AC60      LDR     R3, [R11,#var_2C]
.text:0000AC64      CMP     R3, #0
.text:0000AC68      BLT     errors_with_arguments
.text:0000AC6C      LDR     R3, [R11,#var_2C]
.text:0000AC70      CMP     R3, #3
.text:0000AC74      BGT     errors_with_arguments
.text:0000AC78      LDR     R3, [R11,#third_argument]
.text:0000AC7C      CMP     R3, #0x31
.text:0000AC80      BLE     errors_with_arguments
.text:0000AC84      LDR     R2, [R11,#third_argument]
.text:0000AC88      MOV     R3, #950
.text:0000AC8C      CMP     R2, R3
.text:0000AC90      BGT     errors_with_arguments
.text:0000AC94      LDR     R2, [R11,#third_argument]
.text:0000AC98      MOV     R3, #0x51EB851F
.text:0000ACA0      SMULL  R1, R3, R3, R2
.text:0000ACA4      MOV     R1, R3,ASR#4
.text:0000ACA8      MOV     R3, R2,ASR#31
.text:0000ACAC      RSB    R3, R3, R1
.text:0000ACB0      MOV     R1, #50
.text:0000ACB4      MUL    R3, R1, R3
.text:0000ACB8      RSB    R3, R3, R2
.text:0000ACBC      CMP     R3, #0
.text:0000ACC0      BEQ    loc_ACEC
.text:0000ACC4
.text:0000ACC4 errors_with_arguments
.text:0000ACC4
.text:0000ACC4      LDR     R3, [R11,#argv]
.text:0000ACC8      LDR     R3, [R3]
.text:0000ACCC      MOV     R0, R3 ; path
.text:0000ACD0      BL      __xpg_basename
.text:0000ACD4      MOV     R3, R0
.text:0000ACD8      MOV     R0, #aSErrorsWithArgu ; format
.text:0000ACE0      MOV     R1, R3
.text:0000ACE4      BL      printf
.text:0000ACE8      B      loc_ADD4
.text:0000ACEC ; -----
.text:0000ACEC loc_ACEC ; CODE XREF: main+66C
.text:0000ACEC      LDR     R2, [R11,#third_argument]
.text:0000ACF0      MOV     R3, #499
.text:0000ACF4      CMP     R2, R3
.text:0000ACF8      BGT     loc_AD08
.text:0000ACFC      MOV     R3, #0x64
.text:0000AD00      STR     R3, [R11,#unk_constant]
.text:0000AD04      B      jump_to_write_power

```

```

.text:0000AD08 ; -----
.text:0000AD08
.text:0000AD08 loc_AD08 ; CODE XREF: main+6A4
.text:0000AD08 LDR R2, [R11,#third_argument]
.text:0000AD0C MOV R3, #799
.text:0000AD10 CMP R2, R3
.text:0000AD14 BGT loc_AD24
.text:0000AD18 MOV R3, #0x5F
.text:0000AD1C STR R3, [R11,#unk_constant]
.text:0000AD20 B jump_to_write_power
.text:0000AD24 ; -----
.text:0000AD24
.text:0000AD24 loc_AD24 ; CODE XREF: main+6C0
.text:0000AD24 LDR R2, [R11,#third_argument]
.text:0000AD28 MOV R3, #899
.text:0000AD2C CMP R2, R3
.text:0000AD30 BGT loc_AD40
.text:0000AD34 MOV R3, #0x5A
.text:0000AD38 STR R3, [R11,#unk_constant]
.text:0000AD3C B jump_to_write_power
.text:0000AD40 ; -----
.text:0000AD40
.text:0000AD40 loc_AD40 ; CODE XREF: main+6DC
.text:0000AD40 LDR R2, [R11,#third_argument]
.text:0000AD44 MOV R3, #999
.text:0000AD48 CMP R2, R3
.text:0000AD4C BGT loc_AD5C
.text:0000AD50 MOV R3, #0x55
.text:0000AD54 STR R3, [R11,#unk_constant]
.text:0000AD58 B jump_to_write_power
.text:0000AD5C ; -----
.text:0000AD5C
.text:0000AD5C loc_AD5C ; CODE XREF: main+6F8
.text:0000AD5C LDR R2, [R11,#third_argument]
.text:0000AD60 MOV R3, #1099
.text:0000AD64 CMP R2, R3
.text:0000AD68 BGT jump_to_write_power
.text:0000AD6C MOV R3, #0x50
.text:0000AD70 STR R3, [R11,#unk_constant]
.text:0000AD74
.text:0000AD74 jump_to_write_power ; CODE XREF: main+6B0
.text:0000AD74 ; main+6CC ...
.text:0000AD74 LDR R3, [R11,#var_28]
.text:0000AD78 UXTB R1, R3
.text:0000AD7C LDR R3, [R11,#var_2C]
.text:0000AD80 UXTB R2, R3
.text:0000AD84 LDR R3, [R11,#unk_constant]
.text:0000AD88 UXTB R3, R3
.text:0000AD8C LDR R0, [R11,#third_argument]
.text:0000AD90 UXTH R0, R0
.text:0000AD94 STR R0, [SP,#0x44+var_44]
.text:0000AD98 LDR R0, [R11,#var_24]
.text:0000AD9C BL write_power
.text:0000ADA0 LDR R0, [R11,#var_24]
.text:0000ADA4 MOV R1, #0x5A
.text:0000ADA8 BL read_loop
.text:0000ADAC B loc_ADD4
...

.rodata:0000B378 aSErrorWithArgu DCB "%s: Error with arguments",0xA,0 ; DATA XREF: main+684
...

```

Function names were present in debugging information of the original binary, like `write_power`, `read_loop`. But labels inside functions were named by me.

`optind` name looks familiar. It is from `getopt` \*NIX library intended for command-line parsing—well, this is exactly what happens inside. Then, the 3rd argument (where frequency value is to be passed) is converted from a string to a number using a call to `strtoll()` function.

The value is then checked against various constants. At 0xACEC, it's checked, if it is lesser or equal to 499, and if it is so, 0x64 is to be passed to write\_power() function (which sends a command through USB using send\_msg()). If it is greater than 499, jump to 0xAD08 is occurred.

At 0xAD08 it's checked, if it's lesser or equal to 799. 0x5F is then passed to write\_power() function in case of success.

There are more checks: for 899 at 0xAD24, for 0x999 at 0xAD40 and finally, for 1099 at 0xAD5C. If the input frequency is lesser or equal to 1099, 0x50 will be passed (at 0xAD6C) to write\_power() function. And there is some kind of bug. If the value is still greater than 1099, the value itself is passed into write\_power() function. Oh, it's not a bug, because we can't get here: value is checked first against 950 at 0xAC88, and if it is greater, error message will be displayed and the utility will finish.

Now the table between frequency in MHz and value passed to write\_power() function:

MHz	hexadecimal	decimal
499MHz	0x64	100
799MHz	0x5f	95
899MHz	0x5a	90
999MHz	0x55	85
1099MHz	0x50	80

As it seems, a value passed to the board is gradually decreasing during frequency increasing.

Now we see that value of 950MHz is a hardcoded limit, at least in this utility. Can we trick it?

Let's back to this piece of code:

```
.text:0000AC84    LDR    R2, [R11,#third_argument]
.text:0000AC88    MOV    R3, #950
.text:0000AC8C    CMP    R2, R3
.text:0000AC90    BGT    errors_with_arguments ; I've patched here to 00 00 00 00
```

We must disable BGT branch instruction at 0xAC90 somehow. And this is ARM in ARM mode, because, as we see, all addresses are increasing by 4, i.e., each instruction has size of 4 bytes. NOP (no operation) instruction in ARM mode is just four zero bytes: 00 00 00 00. So by writing four zeros at 0xAC90 address (or physical offset in file 0x2C90) we can disable the check.

Now it's possible to set frequencies up to 1050MHz. Even more is possible, but due to the bug, if input value is greater than 1099, a value as is in MHz will be passed to the board, which is incorrect.

I didn't go further, but if I had to, I would try to decrease a value which is passed to write\_power() function.

Now the scary piece of code which I skipped at first:

```
.text:0000AC94    LDR    R2, [R11,#third_argument]
.text:0000AC98    MOV    R3, #0x51EB851F
.text:0000ACA0    SMULL  R1, R3, R3, R2 ; R3=3rg_arg/3.125
.text:0000ACA4    MOV    R1, R3, ASR#4 ; R1=R3/16=3rg_arg/50
.text:0000ACA8    MOV    R3, R2, ASR#31 ; R3=MSB(3rg_arg)
.text:0000ACAC    RSB   R3, R3, R1 ; R3=3rd_arg/50
.text:0000ACB0    MOV    R1, #50
.text:0000ACB4    MUL   R3, R1, R3 ; R3=50*(3rd_arg/50)
.text:0000ACB8    RSB   R3, R3, R2
.text:0000ACBC    CMP   R3, #0
.text:0000ACC0    BEQ   loc_ACEC
.text:0000ACC4
.text:0000ACC4    errors_with_arguments
```

Division via multiplication is used here, and constant is 0x51EB851F. I wrote a simple programmer's calculator<sup>25</sup> for myself. And I have there a feature to calculate modulo inverse.

<sup>25</sup><https://yurichev.com/progcalc/>

```
modinv32(0x51EB851F)
Warning, result is not integer: 3.125000
(unsigned) dec: 3 hex: 0x3 bin: 11
```

That means that SMULL instruction at 0xACA0 is basically divides 3rd argument by 3.125. In fact, all modinv32() function in my calculator does, is this:

$$\frac{1}{\frac{input}{2^{32}}} = \frac{2^{32}}{input}$$

Then there are additional shifts and now we see than 3rd argument is just divided by 50. And then it's multiplied by 50 again. Why? This is simplest check, if the input value is can be divided by 50 evenly. If the value of this expression is non-zero,  $x$  can't be divided by 50 evenly:

$$x - \left(\left(\frac{x}{50}\right) \cdot 50\right)$$

This is in fact simple way to calculate remainder of division.

And then, if the remainder is non-zero, error message is displayed. So this utility takes frequency values in form like 850, 900, 950, 1000, etc., but not 855 or 911.

That's it! If you do something like that, please be warned that you may damage your board, just as in case of overclocking other devices like CPU's, GPU<sup>26</sup>s, etc. If you have a Cointerra board, do this on your own risk!

## 8.11 Breaking simple executable cryptor

I've got an executable file which is encrypted by relatively simple encryption. [Here is it](#) (only executable section is left here).

First, all encryption function does is just adds number of position in buffer to the byte. Here is how this can be encoded in Python:

Listing 8.9: Python script

```
#!/usr/bin/env python
def e(i, k):
    return chr ((ord(i)+k) % 256)

def encrypt(buf):
    return e(buf[0], 0)+ e(buf[1], 1)+ e(buf[2], 2) + e(buf[3], 3)+ e(buf[4], 4)+ e(buf[5], 5)+↵
    ↵ e(buf[6], 6)+ e(buf[7], 7)+
        e(buf[8], 8)+ e(buf[9], 9)+ e(buf[10], 10)+ e(buf[11], 11)+ e(buf[12], 12)+ e(buf↵
    ↵ [13], 13)+ e(buf[14], 14)+ e(buf[15], 15)
```

Hence, if you encrypt buffer with 16 zeros, you'll get 0, 1, 2, 3 ... 12, 13, 14, 15.

Propagating Cipher Block Chaining (PCBC) is also used, here is how it works:

---

<sup>26</sup>Graphics Processing Unit

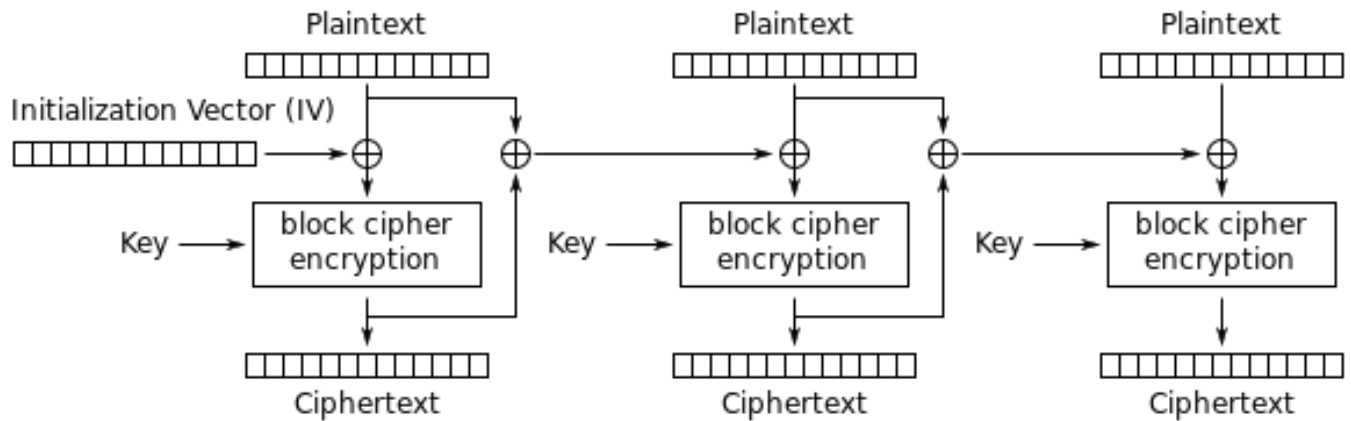

## Propagating Cipher Block Chaining (PCBC) mode encryption

Figure 8.15: Propagating Cipher Block Chaining encryption (image is taken from Wikipedia article)

The problem is that it's too boring to recover IV (Initialization Vector) each time. Brute-force is also not an option, because IV is too long (16 bytes). Let's see, if it's possible to recover IV for arbitrary encrypted executable file?

Let's try simple frequency analysis. This is 32-bit x86 executable code, so let's gather statistics about most frequent bytes and opcodes. I tried huge oracle.exe file from Oracle RDBMS version 11.2 for windows x86 and I've found that the most frequent byte (no surprise) is zero ( 10%). The next most frequent byte is (again, no surprise) 0xFF ( 5%). The next is 0x8B ( 5%).

0x8B is opcode for MOV, this is indeed one of the most busy x86 instructions. Now what about popularity of zero byte? If compiler needs to encode value bigger than 127, it has to use 32-bit displacement instead of 8-bit one, but large values are very rare, so it is padded by zeros. This is at least in LEA, MOV, PUSH, CALL.

For example:

8D B0 28 01 00 00	lea	esi, [eax+128h]
8D BF 40 38 00 00	lea	edi, [edi+3840h]

Displacements bigger than 127 are very popular, but they are rarely exceeds 0x10000 (indeed, such large memory buffers/structures are also rare).

Same story with MOV, large constants are rare, the most heavily used are 0, 1, 10, 100,  $2^n$ , and so on. Compiler has to pad small constants by zeros to represent them as 32-bit values:

BF 02 00 00 00	mov	edi, 2
BF 01 00 00 00	mov	edi, 1

Now about 00 and FF bytes combined: jumps (including conditional) and calls can pass execution flow forward or backwards, but very often, within the limits of the current executable module. If forward, displacement is not very big and also padded with zeros. If backwards, displacement is represented as negative value, so padded with FF bytes. For example, transfer execution flow forward:

E8 43 0C 00 00	call	_function1
E8 5C 00 00 00	call	_function2
0F 84 F0 0A 00 00	jz	loc_4F09A0
0F 84 EB 00 00 00	jz	loc_4EFBB8

Backwards:

```

E8 79 0C FE FF      call    _function1
E8 F4 16 FF FF      call    _function2
0F 84 F8 FB FF FF   jz     loc_8212BC
0F 84 06 FD FF FF   jz     loc_FF1E7D

```

FF byte is also very often occurred in negative displacements like these:

```

8D 85 1E FF FF FF   lea    eax, [ebp-0E2h]
8D 95 F8 5C FF FF   lea    edx, [ebp-0A308h]

```

So far so good. Now we have to try various 16-byte keys, decrypt executable section and measure how often 00, FF and 8B bytes are occurred. Let's also keep in sight how PCBC decryption works:

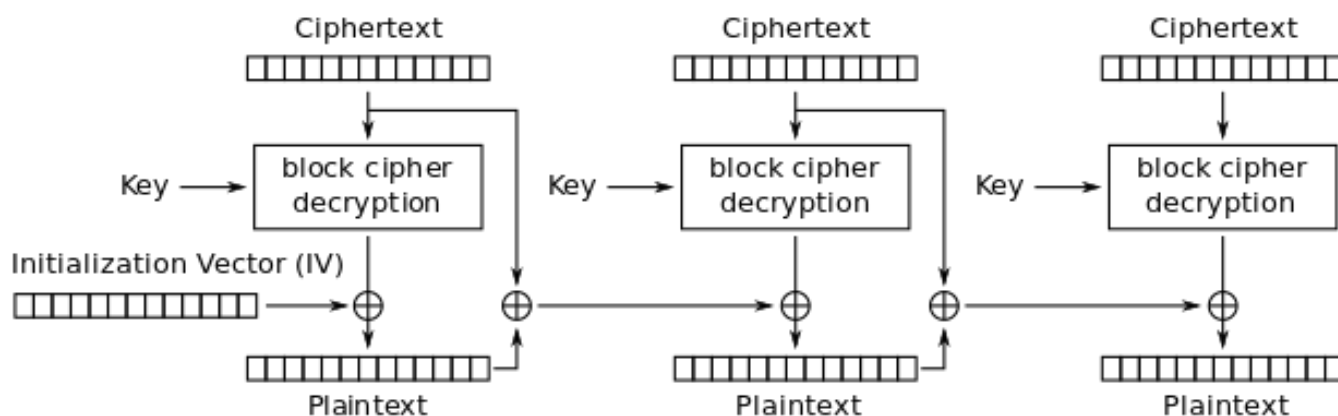

### Propagating Cipher Block Chaining (PCBC) mode decryption

Figure 8.16: Propagating Cipher Block Chaining decryption (image is taken from Wikipedia article)

The good news is that we don't really have to decrypt whole piece of data, but only slice by slice, this is exactly how I did in my previous example: [9.1.5 on page 938](#).

Now I'm trying all possible bytes (0..255) for each byte in key and just pick the byte producing maximal amount of 00/FF/8B bytes in a decrypted slice:

```

#!/usr/bin/env python
import sys, hexdump, array, string, operator

KEY_LEN=16

def chunks(l, n):
    # split n by l-byte chunks
    # https://stackoverflow.com/q/312443
    n = max(1, n)
    return [l[i:i + n] for i in range(0, len(l), n)]

def read_file(fname):
    file=open(fname, mode='rb')
    content=file.read()
    file.close()
    return content

def decrypt_byte (c, key):
    return chr((ord(c)-key) % 256)

def XOR_PCBC_step (IV, buf, k):
    prev=IV

```



```

    rt=""
    for c in buf:
        new_c=decrypt_byte(c, k)
        plain=chr(ord(new_c)^ord(prev))
        prev=chr(ord(c)^ord(plain))
        rt=rt+plain
    return rt

each_nth_byte=[""]*KEY_LEN

content=read_file(sys.argv[1])
# split input by 16-byte chunks:
all_chunks=chunks(content, KEY_LEN)
for c in all_chunks:
    for i in range(KEY_LEN):
        each_nth_byte[i]=each_nth_byte[i] + c[i]

# try each byte of key
for N in range(KEY_LEN):
    print "N=", N
    stat={}
    for i in range(256):
        tmp_key=chr(i)
        tmp=XOR_PCBC_step(tmp_key,each_nth_byte[N], N)
        # count 0, FFs and 8Bs in decrypted buffer:
        important_bytes=tmp.count('\x00')+tmp.count('\xFF')+tmp.count('\x8B')
        stat[i]=important_bytes
    sorted_stat = sorted(stat.iteritems(), key=operator.itemgetter(1), reverse=True)
    print sorted_stat[0]

```

(Source code can be downloaded [here](#).)

I run it and here is a key for which 00/FF/8B bytes presence in decrypted buffer is maximal:

```

N= 0
(147, 1224)
N= 1
(94, 1327)
N= 2
(252, 1223)
N= 3
(218, 1266)
N= 4
(38, 1209)
N= 5
(192, 1378)
N= 6
(199, 1204)
N= 7
(213, 1332)
N= 8
(225, 1251)
N= 9
(112, 1223)
N= 10
(143, 1177)
N= 11
(108, 1286)
N= 12
(10, 1164)
N= 13
(3, 1271)
N= 14
(128, 1253)
N= 15
(232, 1330)

```

Let's write decryption utility with the key we got:

```
#!/usr/bin/env python
import sys, hexdump, array

def xor_strings(s,t):
    # https://en.wikipedia.org/wiki/XOR_cipher#Example_implementation
    """xor two strings together"""
    return "".join(chr(ord(a)^ord(b)) for a,b in zip(s,t))

IV=array.array('B', [147, 94, 252, 218, 38, 192, 199, 213, 225, 112, 143, 108, 10, 3, 128, ↵
↵ 232]).tostring()

def chunks(l, n):
    n = max(1, n)
    return [l[i:i + n] for i in range(0, len(l), n)]

def read_file(fname):
    file=open(fname, mode='rb')
    content=file.read()
    file.close()
    return content

def decrypt_byte(i, k):
    return chr ((ord(i)-k) % 256)

def decrypt(buf):
    return "".join(decrypt_byte(buf[i], i) for i in range(16))

fout=open(sys.argv[2], mode='wb')

prev=IV
content=read_file(sys.argv[1])
tmp=chunks(content, 16)
for c in tmp:
    new_c=decrypt(c)
    p=xor_strings (new_c, prev)
    prev=xor_strings(c, p)
    fout.write(p)
fout.close()
```

(Source code can be downloaded [here](#).)

Let's check resulting file:

```
$ objdump -b binary -m i386 -D decrypted.bin

...

5:      8b ff      mov     %edi,%edi
7:      55        push   %ebp
8:      8b ec     mov     %esp,%ebp
a:      51        push   %ecx
b:      53        push   %ebx
c:      33 db     xor     %ebx,%ebx
e:      43        inc    %ebx
f:      84 1d a0 e2 05 01  test   %bl,0x105e2a0
15:     75 09     jne    0x20
17:     ff 75 08  pushl  0x8(%ebp)
1a:     ff 15 b0 13 00 01  call   *0x10013b0
20:     6a 6c     push   $0x6c
22:     ff 35 54 d0 01 01  pushl  0x101d054
28:     ff 15 b4 13 00 01  call   *0x10013b4
2e:     89 45 fc     mov     %eax, -0x4(%ebp)
31:     85 c0     test   %eax,%eax
33:     0f 84 d9 00 00 00  je     0x112
39:     56        push   %esi
3a:     57        push   %edi
3b:     6a 00     push   $0x0
3d:     50        push   %eax
3e:     ff 15 b8 13 00 01  call   *0x10013b8
```

```

44:      8b 35 bc 13 00 01      mov     0x10013bc,%esi
4a:      8b f8                  mov     %eax,%edi
4c:      a1 e0 e2 05 01      mov     0x105e2e0,%eax
51:      3b 05 e4 e2 05 01      cmp     0x105e2e4,%eax
57:      75 12                  jne     0x6b
59:      53                    push   %ebx
5a:      6a 03                  push   $0x3
5c:      57                    push   %edi
5d:      ff d6                  call   *%esi

```

...

Yes, this is seems correctly disassembled piece of x86 code. The whole decrypted file can be downloaded [here](#).

In fact, this is text section from regedit.exe from Windows 7. But this example is based on a real case I encountered, so just executable is different (and key), algorithm is the same.

### 8.11.1 Other ideas to consider

What if I would fail with such simple frequency analysis? There are other ideas on how to measure correctness of decrypted/decompressed x86 code:

- Many modern compilers aligns functions on 0x10 border. So the space left before is filled with NOPs (0x90) or other NOP instructions with known opcodes: [.1.7 on page 1039](#).
- Perhaps, the most frequent pattern in any assembly language is function call: PUSH chain / CALL / ADD ESP, X. This sequence can easily detected and found. I've even gathered statistics about average number of function arguments: [11.2 on page 994](#). (Hence, this is average length of PUSH chain.)

Read more about incorrectly/correctly disassembled code: [5.11 on page 729](#).

## 8.12 SAP

### 8.12.1 About SAP client network traffic compression

(This article first appeared in my blog, in 13-Jul-2010.)

(Tracing the connection between the TDW\_NOCOMPRESS SAPGUI<sup>27</sup> environment variable and the pesky annoying pop-up window and the actual data compression routine.)

It is known that the network traffic between SAPGUI and SAP is not encrypted by default, but compressed (see here<sup>28</sup> and here<sup>29</sup>).

It is also known that by setting the environment variable *TDW\_NOCOMPRESS* to 1, it is possible to turn the network packet compression off.

But you will see an annoying pop-up window that cannot be closed:

<sup>27</sup>SAP GUI client

<sup>28</sup><http://go.yurichev.com/17221>

<sup>29</sup>[blog.yurichev.com](http://blog.yurichev.com)

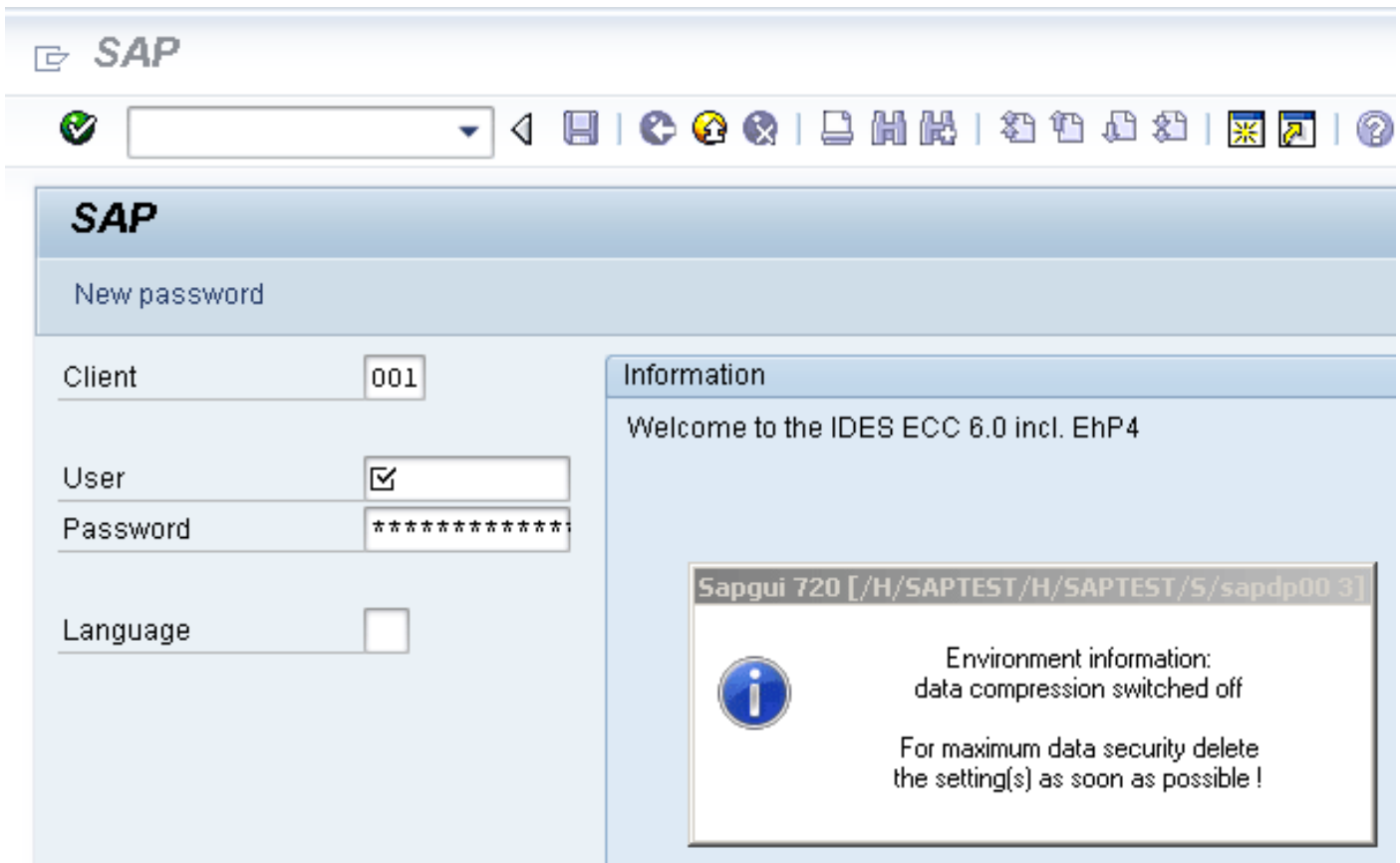

Figure 8.17: Screenshot

Let's see if we can remove the window somehow.

But before this, let's see what we already know.

First: we know that the environment variable *TDW\_NOCOMPRESS* is checked somewhere inside the SAPGUI client.

Second: a string like "data compression switched off" must be present somewhere in it.

With the help of the FAR file manager<sup>30</sup> we can find that both of these strings are stored in the SAPguilib.dll file.

So let's open SAPguilib.dll in IDA and search for the *TDW\_NOCOMPRESS* string. Yes, it is present and there is only one reference to it.

We see the following fragment of code (all file offsets are valid for SAPGUI 720 win32, SAPguilib.dll file version 7200,1,0,9009):

```
.text:6440D51B      lea    eax, [ebp+2108h+var_211C]
.text:6440D51E      push   eax                ; int
.text:6440D51F      push   offset aTdw_nocompress ; "TDW_NOCOMPRESS"
.text:6440D524      mov    byte ptr [edi+15h], 0
.text:6440D528      call  chk_env
.text:6440D52D      pop    ecx
.text:6440D52E      pop    ecx
.text:6440D52F      push   offset byte_64443AF8
.text:6440D534      lea    ecx, [ebp+2108h+var_211C]

; demangled name: int ATL::CStringT::Compare(char const *)const
.text:6440D537      call  ds:mfc90_1603
.text:6440D53D      test   eax, eax
.text:6440D53F      jz    short loc_6440D55A
.text:6440D541      lea    ecx, [ebp+2108h+var_211C]

; demangled name: const char* ATL::CStringT::operator PCWSTR
.text:6440D544      call  ds:mfc90_910
```

<sup>30</sup><http://go.yurichev.com/17347>

```

.text:6440D54A      push    eax                ; Str
.text:6440D54B      call   ds:atoi
.text:6440D551      test   eax, eax
.text:6440D553      setnz  al
.text:6440D556      pop    ecx
.text:6440D557      mov    [edi+15h], al

```

The string returned by `chk_env()` via its second argument is then handled by the MFC string functions and then `atoi()`<sup>31</sup> is called. After that, the numerical value is stored in `edi+15h`.

Also take a look at the `chk_env()` function (we gave this name to it manually):

```

.text:64413F20 ; int __cdecl chk_env(char *VarName, int)
.text:64413F20 chk_env      proc near
.text:64413F20
.text:64413F20 DstSize      = dword ptr -0Ch
.text:64413F20 var_8        = dword ptr -8
.text:64413F20 DstBuf       = dword ptr -4
.text:64413F20 VarName      = dword ptr 8
.text:64413F20 arg_4        = dword ptr 0Ch
.text:64413F20
.text:64413F20      push    ebp
.text:64413F21      mov     ebp, esp
.text:64413F23      sub     esp, 0Ch
.text:64413F26      mov     [ebp+DstSize], 0
.text:64413F2D      mov     [ebp+DstBuf], 0
.text:64413F34      push   offset unk_6444C88C
.text:64413F39      mov     ecx, [ebp+arg_4]

; (demangled name) ATL::CStringT::operator=(char const *)
.text:64413F3C      call   ds:mfc90_820
.text:64413F42      mov     eax, [ebp+VarName]
.text:64413F45      push   eax                ; VarName
.text:64413F46      mov     ecx, [ebp+DstSize]
.text:64413F49      push   ecx                ; DstSize
.text:64413F4A      mov     edx, [ebp+DstBuf]
.text:64413F4D      push   edx                ; DstBuf
.text:64413F4E      lea    eax, [ebp+DstSize]
.text:64413F51      push   eax                ; ReturnSize
.text:64413F52      call   ds:getenv_s
.text:64413F58      add     esp, 10h
.text:64413F5B      mov     [ebp+var_8], eax
.text:64413F5E      cmp    [ebp+var_8], 0
.text:64413F62      jz     short loc_64413F68
.text:64413F64      xor    eax, eax
.text:64413F66      jmp    short loc_64413FBC
.text:64413F68
.text:64413F68 loc_64413F68:
.text:64413F68      cmp    [ebp+DstSize], 0
.text:64413F6C      jnz    short loc_64413F72
.text:64413F6E      xor    eax, eax
.text:64413F70      jmp    short loc_64413FBC
.text:64413F72
.text:64413F72 loc_64413F72:
.text:64413F72      mov    ecx, [ebp+DstSize]
.text:64413F75      push   ecx
.text:64413F76      mov    ecx, [ebp+arg_4]

; demangled name: ATL::CStringT::Preallocate(int)
.text:64413F79      call   ds:mfc90_2691
.text:64413F7F      mov    [ebp+DstBuf], eax
.text:64413F82      mov    edx, [ebp+VarName]
.text:64413F85      push   edx                ; VarName
.text:64413F86      mov    eax, [ebp+DstSize]
.text:64413F89      push   eax                ; DstSize
.text:64413F8A      mov    ecx, [ebp+DstBuf]
.text:64413F8D      push   ecx                ; DstBuf
.text:64413F8E      lea    edx, [ebp+DstSize]
.text:64413F91      push   edx                ; ReturnSize

```

<sup>31</sup>standard C library function that converts the digits in a string to a number

```

.text:64413F92      call    ds:getenv_s
.text:64413F98      add     esp, 10h
.text:64413F9B      mov     [ebp+var_8], eax
.text:64413F9E      push   0FFFFFFFh
.text:64413FA0      mov     ecx, [ebp+arg_4]

; demangled name: ATL::CStringT::ReleaseBuffer(int)
.text:64413FA3      call    ds:mfc90_5835
.text:64413FA9      cmp     [ebp+var_8], 0
.text:64413FAD      jz     short loc_64413FB3
.text:64413FAF      xor     eax, eax
.text:64413FB1      jmp    short loc_64413FBC
.text:64413FB3
.text:64413FB3  loc_64413FB3:
.text:64413FB3      mov     ecx, [ebp+arg_4]

; demangled name: const char* ATL::CStringT::operator PCXSTR
.text:64413FB6      call    ds:mfc90_910
.text:64413FBC
.text:64413FBC  loc_64413FBC:
.text:64413FBC
.text:64413FBC      mov     esp, ebp
.text:64413FBE      pop     ebp
.text:64413FBF      retn
.text:64413FBF  chk_env      endp

```

Yes. The `getenv_s()`<sup>32</sup>

function is a Microsoft security-enhanced version of `getenv()`<sup>33</sup>.

There are also some MFC string manipulations.

Lots of other environment variables are checked as well. Here is a list of all variables that are being checked and what SAPGUI would write to its trace log when logging is turned on:

DPTRACE	"GUI-OPTION: Trace set to %d"
TDW_HEXDUMP	"GUI-OPTION: Hexdump enabled"
TDW_WORKDIR	"GUI-OPTION: working directory '%s'"
TDW_SPLASHSRCEENOFF	"GUI-OPTION: Splash Screen Off"
	"GUI-OPTION: Splash Screen On"
TDW_REPLYTIMEOUT	"GUI-OPTION: reply timeout %d milliseconds"
TDW_PLAYBACKTIMEOUT	"GUI-OPTION: PlaybackTimeout set to %d milliseconds"
TDW_NOCOMPRESS	"GUI-OPTION: no compression read"
TDW_EXPERT	"GUI-OPTION: expert mode"
TDW_PLAYBACKPROGRESS	"GUI-OPTION: PlaybackProgress"
TDW_PLAYBACKNETTRAFFIC	"GUI-OPTION: PlaybackNetTraffic"
TDW_PLAYLOG	"GUI-OPTION: /PlayLog is YES, file %s"
TDW_PLAYTIME	"GUI-OPTION: /PlayTime set to %d milliseconds"
TDW_LOGFILE	"GUI-OPTION: TDW_LOGFILE '%s'"
TDW_WAN	"GUI-OPTION: WAN - low speed connection enabled"
TDW_FULLMENU	"GUI-OPTION: FullMenu enabled"
SAP_CP / SAP_CODEPAGE	"GUI-OPTION: SAP_CODEPAGE '%d'"
UPDOWNLOAD_CP	"GUI-OPTION: UPDOWNLOAD_CP '%d'"
SNC_PARTNERNAME	"GUI-OPTION: SNC name '%s'"
SNC_QOP	"GUI-OPTION: SNC_QOP '%s'"
SNC_LIB	"GUI-OPTION: SNC is set to: %s"
SAPGUI_INPLACE	"GUI-OPTION: environment variable SAPGUI_INPLACE is on"

The settings for each variable are written in the array via a pointer in the EDI register. EDI is set before the function call:

```

.text:6440EE00      lea    edi, [ebp+2884h+var_2884] ; options here like +0x15...
.text:6440EE03      lea    ecx, [esi+24h]
.text:6440EE06      call   load_command_line
.text:6440EE0B      mov     edi, eax
.text:6440EE0D      xor     ebx, ebx
.text:6440EE0F      cmp     edi, ebx

```

<sup>32</sup>MSDN

<sup>33</sup>Standard C library returning environment variable

```
.text:6440EE11      jz      short loc_6440EE42
.text:6440EE13      push   edi
.text:6440EE14      push   offset aSapguiStoppedA ; "Sapgui stopped after
      cmdline interp"...
.text:6440EE19      push   dword_644F93E8
.text:6440EE1F      call   FEWTraceError
```

Now, can we find the *data record mode switched on* string?

Yes, and the only reference is in

CDwsGui::PrepareInfoWindow().

How do we get know the class/method names? There are a lot of special debugging calls that write to the log files, like:

```
.text:64405160      push   dword ptr [esi+2854h]
.text:64405166      push   offset aCdwsGuiPrepare ;
      "\nCDwsGui::PrepareInfoWindow: sapgui env"...
.text:6440516B      push   dword ptr [esi+2848h]
.text:64405171      call   dbg
.text:64405176      add    esp, 0Ch
```

...OR:

```
.text:6440237A      push   eax
.text:6440237B      push   offset aCClientStart_6 ; "CClient::Start: set shortcut
      user to '%"...
.text:64402380      push   dword ptr [edi+4]
.text:64402383      call   dbg
.text:64402388      add    esp, 0Ch
```

It is very useful.

So let's see the contents of this pesky annoying pop-up window's function:

```
.text:64404F4F CDwsGui__PrepareInfoWindow proc near
.text:64404F4F
.text:64404F4F pvParam      = byte ptr -3Ch
.text:64404F4F var_38      = dword ptr -38h
.text:64404F4F var_34      = dword ptr -34h
.text:64404F4F rc          = tagRECT ptr -2Ch
.text:64404F4F cy          = dword ptr -1Ch
.text:64404F4F h           = dword ptr -18h
.text:64404F4F var_14      = dword ptr -14h
.text:64404F4F var_10      = dword ptr -10h
.text:64404F4F var_4       = dword ptr -4
.text:64404F4F
.text:64404F4F      push   30h
.text:64404F51      mov    eax, offset loc_64438E00
.text:64404F56      call  __EH_prolog3
.text:64404F5B      mov    esi, ecx          ; ECX is pointer to object
.text:64404F5D      xor    ebx, ebx
.text:64404F5F      lea   ecx, [ebp+var_14]
.text:64404F62      mov    [ebp+var_10], ebx

; demangled name: ATL::CStringT(void)
.text:64404F65      call  ds:mfc90_316
.text:64404F6B      mov    [ebp+var_4], ebx
.text:64404F6E      lea   edi, [esi+2854h]
.text:64404F74      push  offset aEnvironmentInf ; "Environment information:\n"
.text:64404F79      mov    ecx, edi

; demangled name: ATL::CStringT::operator=(char const *)
.text:64404F7B      call  ds:mfc90_820
.text:64404F81      cmp    [esi+38h], ebx
.text:64404F84      mov    ebx, ds:mfc90_2539
.text:64404F8A      jbe   short loc_64404FA9
.text:64404F8C      push  dword ptr [esi+34h]
.text:64404F8F      lea   eax, [ebp+var_14]
```

```

.text:64404F92      push    offset aWorkingDirecto ; "working directory: '%s'\n"
.text:64404F97      push    eax

; demangled name: ATL::CStringT::Format(char const *,...)
.text:64404F98      call   ebx ; mfc90_2539
.text:64404F9A      add    esp, 0Ch
.text:64404F9D      lea   eax, [ebp+var_14]
.text:64404FA0      push  eax
.text:64404FA1      mov   ecx, edi

; demangled name: ATL::CStringT::operator+=(class ATL::CStringT<char, 1> const &)
.text:64404FA3      call   ds:mfc90_941
.text:64404FA9
.text:64404FA9 loc_64404FA9:
.text:64404FA9      mov   eax, [esi+38h]
.text:64404FAC      test  eax, eax
.text:64404FAE      jbe   short loc_64404FD3
.text:64404FB0      push  eax
.text:64404FB1      lea  eax, [ebp+var_14]
.text:64404FB4      push  offset aTraceLevelDAct ; "trace level %d activated\n"
.text:64404FB9      push  eax

; demangled name: ATL::CStringT::Format(char const *,...)
.text:64404FBA      call   ebx ; mfc90_2539
.text:64404FBC      add    esp, 0Ch
.text:64404FBF      lea   eax, [ebp+var_14]
.text:64404FC2      push  eax
.text:64404FC3      mov   ecx, edi

; demangled name: ATL::CStringT::operator+=(class ATL::CStringT<char, 1> const &)
.text:64404FC5      call   ds:mfc90_941
.text:64404FCB      xor   ebx, ebx
.text:64404FCD      inc   ebx
.text:64404FCE      mov   [ebp+var_10], ebx
.text:64404FD1      jmp   short loc_64404FD6
.text:64404FD3
.text:64404FD3 loc_64404FD3:
.text:64404FD3      xor   ebx, ebx
.text:64404FD5      inc   ebx
.text:64404FD6
.text:64404FD6 loc_64404FD6:
.text:64404FD6      cmp   [esi+38h], ebx
.text:64404FD9      jbe   short loc_64404FF1
.text:64404FDB      cmp   dword ptr [esi+2978h], 0
.text:64404FE2      jz    short loc_64404FF1
.text:64404FE4      push  offset aHexdumpInTrace ; "hexdump in trace activated\n"
.text:64404FE9      mov   ecx, edi

; demangled name: ATL::CStringT::operator+=(char const *)
.text:64404FEB      call   ds:mfc90_945
.text:64404FF1
.text:64404FF1 loc_64404FF1:
.text:64404FF1
.text:64404FF1      cmp   byte ptr [esi+78h], 0
.text:64404FF5      jz    short loc_64405007
.text:64404FF7      push  offset aLoggingActivat ; "logging activated\n"
.text:64404FFC      mov   ecx, edi

; demangled name: ATL::CStringT::operator+=(char const *)
.text:64404FFE      call   ds:mfc90_945
.text:64405004      mov   [ebp+var_10], ebx
.text:64405007
.text:64405007 loc_64405007:
.text:64405007      cmp   byte ptr [esi+3Dh], 0
.text:6440500B      jz    short bypass
.text:6440500D      push  offset aDataCompressio ;
      "data compression switched off\n"
.text:64405012      mov   ecx, edi

; demangled name: ATL::CStringT::operator+=(char const *)

```



```

.text:64405014      call    ds:mfc90_945
.text:6440501A      mov     [ebp+var_10], ebx
.text:6440501D      bypass:
.text:6440501D      mov     eax, [esi+20h]
.text:64405020      test   eax, eax
.text:64405022      jz     short loc_6440503A
.text:64405024      cmp    dword ptr [eax+28h], 0
.text:64405028      jz     short loc_6440503A
.text:6440502A      push   offset aDataRecordMode ; "data record mode switched on\n"
.text:6440502F      mov     ecx, edi

; demangled name: ATL::CStringT::operator+=(char const *)
.text:64405031      call    ds:mfc90_945
.text:64405037      mov     [ebp+var_10], ebx
.text:6440503A      loc_6440503A:
.text:6440503A      mov     ecx, edi
.text:6440503C      cmp    [ebp+var_10], ebx
.text:6440503F      jnz    loc_64405142
.text:64405045      push   offset aForMaximumData ;
"\nFor maximum data security delete\nthe s"...

; demangled name: ATL::CStringT::operator+=(char const *)
.text:6440504A      call    ds:mfc90_945
.text:64405050      xor     edi, edi
.text:64405052      push   edi ; fWinIni
.text:64405053      lea   eax, [ebp+pvParam]
.text:64405056      push   eax ; pvParam
.text:64405057      push   edi ; uiParam
.text:64405058      push   30h ; uiAction
.text:6440505A      call   ds:SystemParametersInfoA
.text:64405060      mov     eax, [ebp+var_34]
.text:64405063      cmp    eax, 1600
.text:64405068      jle    short loc_64405072
.text:6440506A      cdq
.text:6440506B      sub    eax, edx
.text:6440506D      sar    eax, 1
.text:6440506F      mov     [ebp+var_34], eax
.text:64405072      loc_64405072:
.text:64405072      push   edi ; hWnd
.text:64405073      mov     [ebp+cy], 0A0h
.text:6440507A      call   ds:GetDC
.text:64405080      mov     [ebp+var_10], eax
.text:64405083      mov     ebx, 12Ch
.text:64405088      cmp    eax, edi
.text:6440508A      jz     loc_64405113
.text:64405090      push   11h ; i
.text:64405092      call   ds:GetStockObject
.text:64405098      mov     edi, ds>SelectObject
.text:6440509E      push   eax ; h
.text:6440509F      push   [ebp+var_10] ; hdc
.text:644050A2      call   edi ; SelectObject
.text:644050A4      and    [ebp+rc.left], 0
.text:644050A8      and    [ebp+rc.top], 0
.text:644050AC      mov     [ebp+h], eax
.text:644050AF      push   401h ; format
.text:644050B4      lea   eax, [ebp+rc]
.text:644050B7      push   eax ; lprc
.text:644050B8      lea   ecx, [esi+2854h]
.text:644050BE      mov     [ebp+rc.right], ebx
.text:644050C1      mov     [ebp+rc.bottom], 0B4h

; demangled name: ATL::CStringT::GetLength(void)
.text:644050C8      call    ds:mfc90_3178
.text:644050CE      push   eax ; cchText
.text:644050CF      lea   ecx, [esi+2854h]

```

```

; demangled name: const char* ATL::CStringT::operator PCWSTR
.text:644050D5      call     ds:mfc90_910
.text:644050DB      push    eax                ; lpchText
.text:644050DC      push    [ebp+var_10]      ; hdc
.text:644050DF      call   ds:DrawTextA
.text:644050E5      push    4                 ; nIndex
.text:644050E7      call   ds:GetSystemMetrics
.text:644050ED      mov     ecx, [ebp+rc.bottom]
.text:644050F0      sub     ecx, [ebp+rc.top]
.text:644050F3      cmp     [ebp+h], 0
.text:644050F7      lea    eax, [eax+ecx+28h]
.text:644050FB      mov     [ebp+cy], eax
.text:644050FE      jz     short loc_64405108
.text:64405100      push   [ebp+h]           ; h
.text:64405103      push   [ebp+var_10]     ; hdc
.text:64405106      call   edi ; SelectObject
.text:64405108
.text:64405108 loc_64405108:
.text:64405108      push   [ebp+var_10]     ; hdc
.text:6440510B      push   0                ; hWnd
.text:6440510D      call   ds:ReleaseDC
.text:64405113
.text:64405113 loc_64405113:
.text:64405113      mov     eax, [ebp+var_38]
.text:64405116      push   80h              ; uFlags
.text:6440511B      push   [ebp+cy]         ; cy
.text:6440511E      inc    eax
.text:6440511F      push   ebx              ; cx
.text:64405120      push   eax              ; Y
.text:64405121      mov     eax, [ebp+var_34]
.text:64405124      add    eax, 0FFFFFFD4h
.text:64405129      cdq
.text:6440512A      sub    eax, edx
.text:6440512C      sar    eax, 1
.text:6440512E      push   eax              ; X
.text:6440512F      push   0                ; hWndInsertAfter
.text:64405131      push   dword ptr [esi+285Ch] ; hWnd
.text:64405137      call   ds:SetWindowPos
.text:6440513D      xor    ebx, ebx
.text:6440513F      inc    ebx
.text:64405140      jmp    short loc_6440514D
.text:64405142
.text:64405142 loc_64405142:
.text:64405142      push   offset byte_64443AF8

; demangled name: ATL::CStringT::operator=(char const *)
.text:64405147      call   ds:mfc90_820
.text:6440514D
.text:6440514D loc_6440514D:
.text:6440514D      cmp    dword_6450B970, ebx
.text:64405153      jl    short loc_64405188
.text:64405155      call   sub_6441C910
.text:6440515A      mov    dword_644F858C, ebx
.text:64405160      push  dword ptr [esi+2854h]
.text:64405166      push  offset aCdwsguiPrepare ;
"\nCwsgui::PrepareInfoWindow: sapgui env"...
.text:6440516B      push  dword ptr [esi+2848h]
.text:64405171      call  dbg
.text:64405176      add   esp, 0Ch
.text:64405179      mov   dword_644F858C, 2
.text:64405183      call  sub_6441C920
.text:64405188
.text:64405188 loc_64405188:
.text:64405188      or    [ebp+var_4], 0FFFFFFFh
.text:6440518C      lea   ecx, [ebp+var_14]

; demangled name: ATL::CStringT:: CStringT()
.text:6440518F      call  ds:mfc90_601
.text:64405195      call  __EH_epilog3
.text:6440519A      retn

```

```
.text:6440519A CDwsGui__PrepareInfoWindow endp
```

At the start of the function ECX has a pointer to the object (since it is a thiscall ( [3.21.1 on page 547](#))-type of function). In our case, the object obviously has class type of *CDwsGui*. Depending on the option turned on in the object, a specific message part is to be concatenated with the resulting message.

If the value at address `this+0x3D` is not zero, the compression is off:

```
.text:64405007 loc_64405007:
.text:64405007         cmp     byte ptr [esi+3Dh], 0
.text:6440500B         jz     short bypass
.text:6440500D         push   offset aDataCompressio ;
        "data compression switched off\n"
.text:64405012         mov     ecx, edi

; demangled name: ATL::CStringT::operator+=(char const *)
.text:64405014         call   ds:mfc90_945
.text:6440501A         mov     [ebp+var_10], ebx
.text:6440501D         bypass:
```

It is interesting that finally the `var_10` variable state defines whether the message is to be shown at all:

```
.text:6440503C         cmp     [ebp+var_10], ebx
.text:6440503F         jnz    exit ; bypass drawing

; add strings "For maximum data security delete" / "the setting(s) as soon as possible !":
.text:64405045         push   offset aForMaximumData ;
        "\nFor maximum data security delete\nthe s"...
.text:6440504A         call   ds:mfc90_945 ; ATL::CStringT::operator+=(char const *)
.text:64405050         xor     edi, edi
.text:64405052         push   edi ; fWinIni
.text:64405053         lea   eax, [ebp+pvParam]
.text:64405056         push   eax ; pvParam
.text:64405057         push   edi ; uiParam
.text:64405058         push   30h ; uiAction
.text:6440505A         call   ds:SystemParametersInfoA
.text:64405060         mov     eax, [ebp+var_34]
.text:64405063         cmp     eax, 1600
.text:64405068         jle    short loc_64405072
.text:6440506A         cdq
.text:6440506B         sub     eax, edx
.text:6440506D         sar     eax, 1
.text:6440506F         mov     [ebp+var_34], eax
.text:64405072 loc_64405072:

start drawing:

.text:64405072         push   edi ; hWnd
.text:64405073         mov     [ebp+cy], 0A0h
.text:6440507A         call   ds:GetDC
```

Let's check our theory on practice.

JNZ at this line ...

```
.text:6440503F         jnz    exit ; bypass drawing
```

...replace it with just JMP, and we get SAPGUI working without the pesky annoying pop-up window appearing!

Now let's dig deeper and find a connection between the `0x15` offset in the `load_command_line()` (we gave it this name) function and the `this+0x3D` variable in *CDwsGui::PrepareInfoWindow*. Are we sure the value is the same?

We are starting to search for all occurrences of the `0x15` value in code. For a small programs like SAPGUI, it sometimes works. Here is the first occurrence we've got:

```

.text:64404C19 sub_64404C19    proc near
.text:64404C19
.text:64404C19 arg_0          = dword ptr 4
.text:64404C19                push    ebx
.text:64404C1A                push    ebp
.text:64404C1B                push    esi
.text:64404C1C                push    edi
.text:64404C1D                mov     edi, [esp+10h+arg_0]
.text:64404C21                mov     eax, [edi]
.text:64404C23                mov     esi, ecx ; ESI/ECX are pointers to some unknown object.
.text:64404C25                mov     [esi], eax
.text:64404C27                mov     eax, [edi+4]
.text:64404C2A                mov     [esi+4], eax
.text:64404C2D                mov     eax, [edi+8]
.text:64404C30                mov     [esi+8], eax
.text:64404C33                lea    eax, [edi+0Ch]
.text:64404C36                push   eax
.text:64404C37                lea    ecx, [esi+0Ch]

; demangled name: ATL::CStringT::operator=(class ATL::CStringT ... &)
.text:64404C3A                call   ds:mfc90_817
.text:64404C40                mov     eax, [edi+10h]
.text:64404C43                mov     [esi+10h], eax
.text:64404C46                mov     al, [edi+14h]
.text:64404C49                mov     [esi+14h], al
.text:64404C4C                mov     al, [edi+15h] ; copy byte from 0x15 offset
.text:64404C4F                mov     [esi+15h], al ; to 0x15 offset in CDwsGui object

```

The function has been called from the function named *CDwsGui::CopyOptions!* And thanks again for debugging information.

But the real answer is in *CDwsGui::Init()*:

```

.text:6440B0BF loc_6440B0BF:
.text:6440B0BF                mov     eax, [ebp+arg_0]
.text:6440B0C2                push   [ebp+arg_4]
.text:6440B0C5                mov     [esi+2844h], eax
.text:6440B0CB                lea    eax, [esi+28h] ; ESI is pointer to CDwsGui object
.text:6440B0CE                push   eax
.text:6440B0CF                call   CDwsGui__CopyOptions

```

Finally, we understand: the array filled in the *load\_command\_line()* function is actually placed in the *CDwsGui* class, but at address *this+0x28*. *0x15 + 0x28* is exactly *0x3D*. OK, we found the point where the value is copied to.

Let's also find the rest of the places where the *0x3D* offset is used. Here is one of them in the *CDwsGui::SapguiRun* function (again, thanks to the debugging calls):

```

.text:64409D58                cmp     [esi+3Dh], bl ; ESI is pointer to CDwsGui object
.text:64409D5B                lea    ecx, [esi+2B8h]
.text:64409D61                setz   al
.text:64409D64                push   eax ; arg_10 of CConnectionContext::CreateNetwork
.text:64409D65                push   dword ptr [esi+64h]

; demangled name: const char* ATL::CStringT::operator PCXSTR
.text:64409D68                call   ds:mfc90_910
.text:64409D68                ; no arguments
.text:64409D6E                push   eax
.text:64409D6F                lea    ecx, [esi+2BCh]

; demangled name: const char* ATL::CStringT::operator PCXSTR
.text:64409D75                call   ds:mfc90_910
.text:64409D75                ; no arguments
.text:64409D7B                push   eax
.text:64409D7C                push   esi
.text:64409D7D                lea    ecx, [esi+8]
.text:64409D80                call   CConnectionContext__CreateNetwork

```

Let's check our findings.

Replace the `setz al` here with the `xor eax, eax / nop` instructions, clear the `TDW_NOCOMPRESS` environment variable and run SAPGUI. Wow! There pesky annoying window is no more (just as expected, because the variable is not set) but in Wireshark we can see that the network packets are not compressed anymore! Obviously, this is the point where the compression flag is to be set in the `CConnectionContext` object.

So, the compression flag is passed in the 5th argument of `CConnectionContext::CreateNetwork`. Inside the function, another one is called:

```
...
.text:64403476      push    [ebp+compression]
.text:64403479      push    [ebp+arg_C]
.text:6440347C      push    [ebp+arg_8]
.text:6440347F      push    [ebp+arg_4]
.text:64403482      push    [ebp+arg_0]
.text:64403485      call   CNetwork__CNetwork
```

The compression flag is passed here in the 5th argument to the `CNetwork::CNetwork` constructor.

And here is how the `CNetwork` constructor sets the flag in the `CNetwork` object according to its 5th argument *and* another variable which probably could also affect network packets compression.

```
.text:64411DF1      cmp     [ebp+compression], esi
.text:64411DF7      jz     short set_EAX_to_0
.text:64411DF9      mov    al, [ebx+78h] ; another value may affect compression?
.text:64411DFC      cmp    al, '3'
.text:64411DFE      jz     short set_EAX_to_1
.text:64411E00      cmp    al, '4'
.text:64411E02      jnz   short set_EAX_to_0
.text:64411E04      set_EAX_to_1:
.text:64411E04      xor    eax, eax
.text:64411E06      inc    eax ; EAX -> 1
.text:64411E07      jmp    short loc_64411E0B
.text:64411E09      set_EAX_to_0:
.text:64411E09      xor    eax, eax ; EAX -> 0
.text:64411E0B      loc_64411E0B:
.text:64411E0B      mov    [ebx+3A4h], eax ; EBX is pointer to CNetwork object
```

At this point we know the compression flag is stored in the `CNetwork` class at address `this+0x3A4`.

Now let's dig through `SAPguilib.dll` for the `0x3A4` value. And here is the second occurrence in `CDwsGui::OnClientMessageWrite` (endless thanks for the debugging information):

```
.text:64406F76      loc_64406F76:
.text:64406F76      mov    ecx, [ebp+7728h+var_7794]
.text:64406F79      cmp    dword ptr [ecx+3A4h], 1
.text:64406F80      jnz   compression_flag_is_zero
.text:64406F86      mov    byte ptr [ebx+7], 1
.text:64406F8A      mov    eax, [esi+18h]
.text:64406F8D      mov    ecx, eax
.text:64406F8F      test   eax, eax
.text:64406F91      ja    short loc_64406FFF
.text:64406F93      mov    ecx, [esi+14h]
.text:64406F96      mov    eax, [esi+20h]
.text:64406F99      loc_64406F99:
.text:64406F99      push  dword ptr [edi+2868h] ; int
.text:64406F9F      lea   edx, [ebp+7728h+var_77A4]
.text:64406FA2      push  edx ; int
.text:64406FA3      push  30000 ; int
.text:64406FA8      lea   edx, [ebp+7728h+Dst]
.text:64406FAB      push  edx ; Dst
.text:64406FAC      push  ecx ; int
.text:64406FAD      push  eax ; Src
```

```
.text:64406FAE      push    dword ptr [edi+28C0h] ; int
.text:64406FB4      call   sub_644055C5          ; actual compression routine
.text:64406FB9      add    esp, 1Ch
.text:64406FBC      cmp    eax, 0FFFFFFF6h
.text:64406FBF      jz     short loc_64407004
.text:64406FC1      cmp    eax, 1
.text:64406FC4      jz     loc_6440708C
.text:64406FCA      cmp    eax, 2
.text:64406FCD      jz     short loc_64407004
.text:64406FCF      push  eax
.text:64406FD0      push  offset aCompressionErr ;
      "compression error [rc = %d]- program wi"...
.text:64406FD5      push  offset aGui_err_compre ; "GUI_ERR_COMPRESS"
.text:64406FDA      push  dword ptr [edi+28D0h]
.text:64406FE0      call  SapPcTxtRead
```

Let's take a look in `sub_644055C5`. In it we can only see the call to `memcpy()` and another function named (by IDA) `sub_64417440`.

And, let's take a look inside `sub_64417440`. What we see is:

```
.text:6441747C      push  offset aErrorCsrcompre ;
      "\nERROR: CsRCompress: invalid handle"
.text:64417481      call  eax ; dword_644F94C8
.text:64417483      add  esp, 4
```

Voilà! We've found the function that actually compresses the data. As it was shown in past <sup>34</sup>, this function is used in SAP and also the open-source MaxDB project. So it is available in source form. Doing the last check here:

```
.text:64406F79      cmp    dword ptr [ecx+3A4h], 1
.text:64406F80      jnz   compression_flag_is_zero
```

Replace JNZ here for an unconditional JMP. Remove the environment variable `TDW_NOCOMPRESS`. Voilà! In Wireshark we see that the client messages are not compressed. The server responses, however, are compressed.

So we found exact connection between the environment variable and the point where data compression routine can be called or bypassed.

## 8.12.2 SAP 6.0 password checking functions

One time when the author of this book have returned again to his SAP 6.0 IDES installed in a VMware box, he figured out that he forgot the password for the SAP\* account, then he have recalled it, but then he got this error message «*Password logon no longer possible - too many failed attempts*», since he've made all these attempts in attempt to recall it.

The first extremely good news was that the full `disp+work.pdb` PDB file is supplied with SAP, and it contain almost everything: function names, structures, types, local variable and argument names, etc. What a lavish gift!

There is `TYPEINFODUMP`<sup>35</sup> utility for converting PDB files into something readable and grepable.

Here is an example of a function information + its arguments + its local variables:

```
FUNCTION ThVmcSysEvent
  Address:      10143190  Size:      675 bytes  Index:      60483  TypeIndex:   60484
  Type: int NEAR_C ThVmcSysEvent (unsigned int, unsigned char, unsigned short*)
Flags: 0
PARAMETER events
  Address: Reg335+288  Size:      4 bytes  Index:      60488  TypeIndex:   60489
  Type: unsigned int
Flags: d0
PARAMETER opcode
```

<sup>34</sup><http://go.yurichev.com/17312>

<sup>35</sup><http://go.yurichev.com/17038>

```

Address: Reg335+296 Size:      1 bytes Index:   60490 TypeIndex:   60491
Type: unsigned char
Flags: d0
PARAMETER serverName
Address: Reg335+304 Size:      8 bytes Index:   60492 TypeIndex:   60493
Type: unsigned short*
Flags: d0
STATIC_LOCAL_VAR func
Address:      12274af0 Size:      8 bytes Index:   60495 TypeIndex:   60496
Type: wchar_t*
Flags: 80
LOCAL_VAR admhead
Address: Reg335+304 Size:      8 bytes Index:   60498 TypeIndex:   60499
Type: unsigned char*
Flags: 90
LOCAL_VAR record
Address: Reg335+64 Size:     204 bytes Index:   60501 TypeIndex:   60502
Type: AD_RECORD
Flags: 90
LOCAL_VAR adlen
Address: Reg335+296 Size:      4 bytes Index:   60508 TypeIndex:   60509
Type: int
Flags: 90

```

And here is an example of some structure:

```

STRUCT DBSL_STMTID
Size: 120 Variables: 4 Functions: 0 Base classes: 0
MEMBER moduletype
Type: DBSL_MODULETYPE
Offset: 0 Index: 3 TypeIndex: 38653
MEMBER module
Type: wchar_t module[40]
Offset: 4 Index: 3 TypeIndex: 831
MEMBER stmtnum
Type: long
Offset: 84 Index: 3 TypeIndex: 440
MEMBER timestamp
Type: wchar_t timestamp[15]
Offset: 88 Index: 3 TypeIndex: 6612

```

Wow!

Another good news: *debugging* calls (there are plenty of them) are very useful.

Here you can also notice the *ct\_level* global variable<sup>36</sup>, that reflects the current trace level.

There are a lot of debugging inserts in the *disp+work.exe* file:

```

cmp     cs:ct_level, 1
jl     short loc_1400375DA
call   DpLock
lea    rcx, aDpxxtool4_c ; "dpxxtool4.c"
mov    edx, 4Eh          ; line
call   CTrcSaveLocation
mov    r8, cs:func_48
mov    rcx, cs:hdl      ; hdl
lea    rdx, aSDpreadmemvalu ; "%s: DpReadMemValue (%d)"
mov    r9d, ebx
call   DpTrcErr
call   DpUnlock

```

If the current trace level is bigger or equal to threshold defined in the code here, a debugging message is to be written to the log files like *dev\_w0*, *dev\_disp*, and other *dev\** files.

Let's try grepping in the file that we have got with the help of the TYPEINFODUMP utility:

```
cat "disp+work.pdb.d" | grep FUNCTION | grep -i password
```

<sup>36</sup>More about trace level: <http://go.yurichev.com/17039>

We have got:

```
FUNCTION rcui::AgiPassword::DiagISelection
FUNCTION ssf_password_encrypt
FUNCTION ssf_password_decrypt
FUNCTION password_logon_disabled
FUNCTION dySignSkipUserPassword
FUNCTION migrate_password_history
FUNCTION password_is_initial
FUNCTION rcui::AgiPassword::IsVisible
FUNCTION password_distance_ok
FUNCTION get_password_downwards_compatibility
FUNCTION dySignUnSkipUserPassword
FUNCTION rcui::AgiPassword::GetTypeNames
FUNCTION `rcui::AgiPassword::AgiPassword'::`1'::dtor$2
FUNCTION `rcui::AgiPassword::AgiPassword'::`1'::dtor$0
FUNCTION `rcui::AgiPassword::AgiPassword'::`1'::dtor$1
FUNCTION usm_set_password
FUNCTION rcui::AgiPassword::TraceTo
FUNCTION days_since_last_password_change
FUNCTION rsecgrp_generate_random_password
FUNCTION rcui::AgiPassword::~`scalar deleting destructor'
FUNCTION password_attempt_limit_exceeded
FUNCTION handle_incorrect_password
FUNCTION `rcui::AgiPassword::~`scalar deleting destructor'::`1'::dtor$1
FUNCTION calculate_new_password_hash
FUNCTION shift_password_to_history
FUNCTION rcui::AgiPassword::GetType
FUNCTION found_password_in_history
FUNCTION `rcui::AgiPassword::~`scalar deleting destructor'::`1'::dtor$0
FUNCTION rcui::AgiObj::IsaPassword
FUNCTION password_idle_check
FUNCTION SlicHwPasswordForDay
FUNCTION rcui::AgiPassword::IsaPassword
FUNCTION rcui::AgiPassword::AgiPassword
FUNCTION delete_user_password
FUNCTION usm_set_user_password
FUNCTION Password_API
FUNCTION get_password_change_for_SSO
FUNCTION password_in_USR40
FUNCTION rsec_agrp_abap_generate_random_password
```

Let's also try to search for debug messages which contain the words «password» and «locked». One of them is the string «user was locked by subsequently failed password logon attempts», referenced in function `password_attempt_limit_exceeded()`.

Other strings that this function can write to a log file are: «password logon attempt will be rejected immediately (preventing dictionary attacks)», «failed-logon lock: expired (but not removed due to 'read-only' operation)», «failed-logon lock: expired => removed».

After playing for a little with this function, we noticed that the problem is exactly in it. It is called from the `chkpass()` function —one of the password checking functions.

First, we would like to make sure that we are at the correct point:

Run [tracer](#):

```
tracer64.exe -a:disp+work.exe bpf=disp+work.exe!chkpass,args:3,unicode
```

```
PID=2236|TID=2248|(0) disp+work.exe!chkpass (0x202c770, L"Brewered1
  ↙   ", 0x41) (called from 0x1402f1060 (disp+work.exe!usrexist+0x3c0))
PID=2236|TID=2248|(0) disp+work.exe!chkpass -> 0x35
```

The call path is: `syssigni()` -> `DyISigni()` -> `dychkusr()` -> `usrexist()` -> `chkpass()`.

The number 0x35 is an error returned in `chkpass()` at that point:



```
.text:00000001402ED567 loc_1402ED567:          ; CODE XREF: chckpass+B4
.text:00000001402ED567          mov     rcx, rbx          ; usr02
.text:00000001402ED56A          call   password_idle_check
.text:00000001402ED56F          cmp     eax, 33h
.text:00000001402ED572          jz     loc_1402EDB4E
.text:00000001402ED578          cmp     eax, 36h
.text:00000001402ED57B          jz     loc_1402EDB3D
.text:00000001402ED581          xor     edx, edx          ; usr02_readonly
.text:00000001402ED583          mov     rcx, rbx          ; usr02
.text:00000001402ED586          call   password_attempt_limit_exceeded
.text:00000001402ED58B          test    al, al
.text:00000001402ED58D          jz     short loc_1402ED5A0
.text:00000001402ED58F          mov     eax, 35h
.text:00000001402ED594          add     rsp, 60h
.text:00000001402ED598          pop     r14
.text:00000001402ED59A          pop     r12
.text:00000001402ED59C          pop     rdi
.text:00000001402ED59D          pop     rsi
.text:00000001402ED59E          pop     rbx
.text:00000001402ED59F          retn
```

Fine, let's check:

```
tracer64.exe -a:disp+work.exe bpf=disp+work.exe!password_attempt_limit_exceeded,args:4,unicode,↵
↳ rt:0
```

```
PID=2744|TID=360|(0) disp+work.exe!password_attempt_limit_exceeded (0x202c770, 0, 0x257758, 0) ↵
↳ (called from 0x1402ed58b (disp+work.exe!chckpass+0xeb))
PID=2744|TID=360|(0) disp+work.exe!password_attempt_limit_exceeded -> 1
PID=2744|TID=360|We modify return value (EAX/RAX) of this function to 0
PID=2744|TID=360|(0) disp+work.exe!password_attempt_limit_exceeded (0x202c770, 0, 0, 0) (called ↵
↳ from 0x1402e9794 (disp+work.exe!chngpass+0xe4))
PID=2744|TID=360|(0) disp+work.exe!password_attempt_limit_exceeded -> 1
PID=2744|TID=360|We modify return value (EAX/RAX) of this function to 0
```

Excellent! We can successfully login now.

By the way, we can pretend we forgot the password, fixing the *chckpass()* function to return a value of 0 is enough to bypass the check:

```
tracer64.exe -a:disp+work.exe bpf=disp+work.exe!chckpass,args:3,unicode,rt:0
```

```
PID=2744|TID=360|(0) disp+work.exe!chckpass (0x202c770, L"bogus ↵
↳ ", 0x41) (called from 0x1402f1060 (disp+work.exe!usrexist+0x3c0))
PID=2744|TID=360|(0) disp+work.exe!chckpass -> 0x35
PID=2744|TID=360|We modify return value (EAX/RAX) of this function to 0
```

What also can be said while analyzing the *password\_attempt\_limit\_exceeded()* function is that at the very beginning of it, this call can be seen:

```
lea     rcx, aLoginFailed_us ; "login/failed_user_auto_unlock"
call    sapparam
test    rax, rax
jz      short loc_1402E19DE
movzx   eax, word ptr [rax]
cmp     ax, 'N'
jz      short loc_1402E19D4
cmp     ax, 'n'
jz      short loc_1402E19D4
cmp     ax, '0'
jnz     short loc_1402E19DE
```

Obviously, function *sappparam()* is used to query the value of some configuration parameter. This function can be called from 1768 different places. It seems that with the help of this information, we can easily find the places in code, the control flow of which can be affected by specific configuration parameters.

It is really sweet. The function names are very clear, much clearer than in the Oracle RDBMS.

It seems that the *disp+work* process is written in C++. Has it been rewritten some time ago?

## 8.13 Oracle RDBMS

### 8.13.1 V\$VERSION table in the Oracle RDBMS

Oracle RDBMS 11.2 is a huge program, its main module `oracle.exe` contain approx. 124,000 functions. For comparison, the Windows 7 x86 kernel (`ntoskrnl.exe`) contains approx. 11,000 functions and the Linux 3.9.8 kernel (with default drivers compiled)—31,000 functions.

Let's start with an easy question. Where does Oracle RDBMS get all this information, when we execute this simple statement in SQL\*Plus:

```
SQL> select * from V$VERSION;
```

And we get:

```
BANNER
-----
Oracle Database 11g Enterprise Edition Release 11.2.0.1.0 - Production
PL/SQL Release 11.2.0.1.0 - Production
CORE      11.2.0.1.0      Production
TNS for 32-bit Windows: Version 11.2.0.1.0 - Production
NLSRTL Version 11.2.0.1.0 - Production
```

Let's start. Where in the Oracle RDBMS can we find the string `V$VERSION`?

In the win32-version, `oracle.exe` file contains the string, it's easy to see. But we can also use the object (.o) files from the Linux version of Oracle RDBMS since, unlike the win32 version `oracle.exe`, the function names (and global variables as well) are preserved there.

So, the `kqf.o` file contains the `V$VERSION` string. The object file is in the main Oracle-library `libserver11.a`.

A reference to this text string can find in the `kqfviv` table stored in the same file, `kqf.o`:

Listing 8.10: `kqf.o`

```
.rodata:0800C4A0 kqfviv dd 0Bh      ; DATA XREF: kqfchk:loc_8003A6D
.rodata:0800C4A0                ; kqfgbn+34
.rodata:0800C4A4                dd offset _2__STRING_10102_0 ; "GV$WAITSTAT"
.rodata:0800C4A8                dd 4
.rodata:0800C4AC                dd offset _2__STRING_10103_0 ; "NULL"
.rodata:0800C4B0                dd 3
.rodata:0800C4B4                dd 0
.rodata:0800C4B8                dd 195h
.rodata:0800C4BC                dd 4
.rodata:0800C4C0                dd 0
.rodata:0800C4C4                dd 0FFFFFFC1CBh
.rodata:0800C4C8                dd 3
.rodata:0800C4CC                dd 0
.rodata:0800C4D0                dd 0Ah
.rodata:0800C4D4                dd offset _2__STRING_10104_0 ; "V$WAITSTAT"
.rodata:0800C4D8                dd 4
.rodata:0800C4DC                dd offset _2__STRING_10103_0 ; "NULL"
.rodata:0800C4E0                dd 3
.rodata:0800C4E4                dd 0
.rodata:0800C4E8                dd 4Eh
.rodata:0800C4EC                dd 3
.rodata:0800C4F0                dd 0
.rodata:0800C4F4                dd 0FFFFFFC003h
.rodata:0800C4F8                dd 4
.rodata:0800C4FC                dd 0
.rodata:0800C500                dd 5
.rodata:0800C504                dd offset _2__STRING_10105_0 ; "GV$BH"
```

```

.rodata:0800C508      dd 4
.rodata:0800C50C      dd offset _2__STRING_10103_0 ; "NULL"
.rodata:0800C510      dd 3
.rodata:0800C514      dd 0
.rodata:0800C518      dd 269h
.rodata:0800C51C      dd 15h
.rodata:0800C520      dd 0
.rodata:0800C524      dd 0FFFFFFC1EDh
.rodata:0800C528      dd 8
.rodata:0800C52C      dd 0
.rodata:0800C530      dd 4
.rodata:0800C534      dd offset _2__STRING_10106_0 ; "V$BH"
.rodata:0800C538      dd 4
.rodata:0800C53C      dd offset _2__STRING_10103_0 ; "NULL"
.rodata:0800C540      dd 3
.rodata:0800C544      dd 0
.rodata:0800C548      dd 0F5h
.rodata:0800C54C      dd 14h
.rodata:0800C550      dd 0
.rodata:0800C554      dd 0FFFFFFC1EEh
.rodata:0800C558      dd 5
.rodata:0800C55C      dd 0

```

By the way, often, while analyzing Oracle RDBMS's internals, you may ask yourself, why are the names of the functions and global variable so weird.

Probably, because Oracle RDBMS is a very old product and was developed in C in the 1980s.

And that was a time when the C standard guaranteed that the function names/variables can support only up to 6 characters inclusive: «6 significant initial characters in an external identifier»<sup>37</sup>

Probably, the table `kqfviw` contains most (maybe even all) views prefixed with `V$`, these are *fixed views*, present all the time. Superficially, by noticing the cyclic recurrence of data, we can easily see that each `kqfviw` table element has 12 32-bit fields. It is very simple to create a 12-elements structure in `IDA` and apply it to all table elements. As of Oracle RDBMS version 11.2, there are 1023 table elements, i.e., in it are described 1023 of all possible *fixed views*.

We are going to return to this number later.

As we can see, there is not much information in these numbers in the fields. The first field is always equals to the name of the view (without the terminating zero). This is correct for each element. But this information is not very useful.

We also know that the information about all fixed views can be retrieved from a *fixed view* named `V$FIXED_VIEW_DEFINITION` (by the way, the information for this view is also taken from the `kqfviw` and `kqfvip` tables.) Incidentally, there are 1023 elements in those too. Coincidence? No.

```
SQL> select * from V$FIXED_VIEW_DEFINITION where view_name='V$VERSION';
```

```

VIEW_NAME
-----
VIEW_DEFINITION
-----

V$VERSION
select  BANNER from GV$VERSION where inst_id = USERENV('Instance')

```

So, `V$VERSION` is some kind of a *thunk view* for another view, named `GV$VERSION`, which is, in turn:

```
SQL> select * from V$FIXED_VIEW_DEFINITION where view_name='GV$VERSION';
```

```

VIEW_NAME
-----
VIEW_DEFINITION
-----

GV$VERSION
select  inst_id, banner from x$version

```

<sup>37</sup>[Draft ANSI C Standard \(ANSI X3J11/88-090\) \(May 13, 1988\) \(yurichev.com\)](http://draft-ansi.org/ANSI_X3J11/88-090/)

The tables prefixed with X\$ in the Oracle RDBMS are service tables too, undocumented, cannot be changed by the user and are refreshed dynamically.

If we search for the text

```
select BANNER from GV$VERSION where inst_id =
USERENV('Instance')
```

... in the kqf.o file, we find it in the kqfvip table:

Listing 8.11: kqf.o

```
.rodata:080185A0 kqfvip dd offset _2_STRING_11126_0 ; DATA XREF: kqfgvcn+18
.rodata:080185A0 ; kqfgvt+F
.rodata:080185A0 ; "select inst_id,decode(indx,1,'data bloc"...
.rodata:080185A4 dd offset kqfv459_c_0
.rodata:080185A8 dd 0
.rodata:080185AC dd 0
...
.rodata:08019570 dd offset _2_STRING_11378_0 ;
"select BANNER from GV$VERSION where in"...
.rodata:08019574 dd offset kqfv133_c_0
.rodata:08019578 dd 0
.rodata:0801957C dd 0
.rodata:08019580 dd offset _2_STRING_11379_0 ;
"select inst_id,decode(bitand(cfflg,1),0)"...
.rodata:08019584 dd offset kqfv403_c_0
.rodata:08019588 dd 0
.rodata:0801958C dd 0
.rodata:08019590 dd offset _2_STRING_11380_0 ;
"select STATUS , NAME, IS_RECOVERY_DEST"...
.rodata:08019594 dd offset kqfv199_c_0
```

The table appear to have 4 fields in each element. By the way, there are 1023 elements in it, again, the number we already know.

The second field points to another table that contains the table fields for this *fixed view*. As for V\$VERSION, this table has only two elements, the first is 6 and the second is the BANNER string (the number 6 is this string's length) and after, a *terminating* element that contains 0 and a *null* C string:

Listing 8.12: kqf.o

```
.rodata:080BBAC4 kqfv133_c_0 dd 6 ; DATA XREF: .rodata:08019574
.rodata:080BBAC8 dd offset _2_STRING_5017_0 ; "BANNER"
.rodata:080BBACC dd 0
.rodata:080BBAD0 dd offset _2_STRING_0_0
```

By joining data from both kqfviv and kqfvip tables, we can get the SQL statements which are executed when the user wants to query information from a specific *fixed view*.

So we can write an oracle tables<sup>38</sup> program, to gather all this information from Oracle RDBMS for Linux's object files. For V\$VERSION, we find this:

Listing 8.13: Result of oracle tables

```
kqfviv_element.viewname: [V$VERSION]?: 0x3 0x43 0x1 0xffffc085 0x4
kqfvip_element.statement: [select BANNER from GV$VERSION where inst_id = USERENV('Instance')]
kqfvip_element.params:
[BANNER]
```

And:

<sup>38</sup>[yurichev.com](http://yurichev.com)

### Listing 8.14: Result of oracle tables

```
kqfviw_element.viewname: [GV$VERSION]?: 0x3 0x26 0x2 0xffffc192 0x1
kqfvip_element.statement: [select inst_id, banner from x$version]
kqfvip_element.params:
[INST_ID] [BANNER]
```

The `GV$VERSION` *fixed view* is different from `V$VERSION` only in that it has one more field with the identifier *instance*.

Anyway, we are going to stick with the `X$VERSION` table. Just like any other `X$`-table, it is undocumented, however, we can query it:

```
SQL> select * from x$version;

ADDR          INDX    INST_ID
-----
BANNER
-----

0DBAF574      0        1
Oracle Database 11g Enterprise Edition Release 11.2.0.1.0 - Production
...
```

This table has some additional fields, like `ADDR` and `INDX`.

While scrolling `kqf.o` in [IDA](#) we can spot another table that contains a pointer to the `X$VERSION` string, this is `kqftab`:

### Listing 8.15: kqf.o

```
.rodata:0803CAC0 dd 9 ; element number 0x1f6
.rodata:0803CAC4 dd offset _2__STRING_13113_0 ; "X$VERSION"
.rodata:0803CAC8 dd 4
.rodata:0803CACC dd offset _2__STRING_13114_0 ; "kqvt"
.rodata:0803CAD0 dd 4
.rodata:0803CAD4 dd 4
.rodata:0803CAD8 dd 0
.rodata:0803CADC dd 4
.rodata:0803CAE0 dd 0Ch
.rodata:0803CAE4 dd 0FFFFFFC075h
.rodata:0803CAE8 dd 3
.rodata:0803CAEC dd 0
.rodata:0803CAF0 dd 7
.rodata:0803CAF4 dd offset _2__STRING_13115_0 ; "X$KQFSZ"
.rodata:0803CAF8 dd 5
.rodata:0803CAFC dd offset _2__STRING_13116_0 ; "kqfsz"
.rodata:0803CB00 dd 1
.rodata:0803CB04 dd 38h
.rodata:0803CB08 dd 0
.rodata:0803CB0C dd 7
.rodata:0803CB10 dd 0
.rodata:0803CB14 dd 0FFFFFFC09Dh
.rodata:0803CB18 dd 2
.rodata:0803CB1C dd 0
```

There are a lot of references to the `X$`-table names, apparently, to all Oracle RDBMS 11.2 `X$`-tables. But again, we don't have enough information.

It's not clear what does the `kqvt` string stands for.

The `kq` prefix may mean *kernel* or *query*.

`v` apparently stands for *version* and `t`—*type*? Hard to say.

A table with a similar name can be found in `kqf.o`:

### Listing 8.16: kqf.o

```
.rodata:0808C360 kqvt_c_0 kqftap_param <4, offset _2__STRING_19_0, 917h, 0, 0, 0, 4, 0, 0>
.rodata:0808C360 ; DATA XREF: .rodata:08042680
.rodata:0808C360 ; "ADDR"
```

```

.rodata:0808C384      kqftap_param <4, offset _2__STRING_20_0, 0B02h, 0, 0, 0, 4, 0, 0> ;
      "INDX"
.rodata:0808C3A8      kqftap_param <7, offset _2__STRING_21_0, 0B02h, 0, 0, 0, 4, 0, 0> ;
      "INST_ID"
.rodata:0808C3CC      kqftap_param <6, offset _2__STRING_5017_0, 601h, 0, 0, 0, 50h, 0, 0> ↵
      ↵ ;
      "BANNER"
.rodata:0808C3F0      kqftap_param <0, offset _2__STRING_0_0, 0, 0, 0, 0, 0, 0, 0>

```

It contains information about all fields in the X\$VERSION table. The only reference to this table is in the kqftap table:

Listing 8.17: kqf.o

```

.rodata:08042680      kqftap_element <0, offset kqvt_c_0, offset kqvrow, 0> ; ↵
      ↵ element 0x1f6

```

It is interesting that this element here is 0x1f6th (502nd), just like the pointer to the X\$VERSION string in the kqftab table.

Probably, the kqftap and kqftab tables complement each other, just like kqfvip and kqfviw.

We also see a pointer to the kqvrow() function. Finally, we got something useful!

So we will add these tables to our oracle tables<sup>39</sup> utility too. For X\$VERSION we get:

Listing 8.18: Result of oracle tables

```

kqftab_element.name: [X$VERSION] ?: [kqvt] 0x4 0x4 0x4 0xc 0xffffc075 0x3
kqftap_param.name=[ADDR] ?: 0x917 0x0 0x0 0x0 0x4 0x0 0x0
kqftap_param.name=[INDX] ?: 0xb02 0x0 0x0 0x0 0x4 0x0 0x0
kqftap_param.name=[INST_ID] ?: 0xb02 0x0 0x0 0x0 0x4 0x0 0x0
kqftap_param.name=[BANNER] ?: 0x601 0x0 0x0 0x0 0x50 0x0 0x0
kqftap_element.fn1=kqvrow
kqftap_element.fn2=NULL

```

With the help of [tracer](#), it is easy to check that this function is called 6 times in row (from the qerfxFetch() function) while querying the X\$VERSION table.

Let's run [tracer](#) in cc mode (it comments each executed instruction):

```

tracer -a:oracle.exe bpf=oracle.exe!_kqvrow,trace:cc

```

```

_kqvrow_  proc near
var_7C   = byte ptr -7Ch
var_18   = dword ptr -18h
var_14   = dword ptr -14h
Dest     = dword ptr -10h
var_C    = dword ptr -0Ch
var_8    = dword ptr -8
var_4    = dword ptr -4
arg_8    = dword ptr 10h
arg_C    = dword ptr 14h
arg_14   = dword ptr 1Ch
arg_18   = dword ptr 20h

; FUNCTION CHUNK AT .text1:056C11A0 SIZE 00000049 BYTES

        push    ebp
        mov     ebp, esp
        sub     esp, 7Ch
        mov     eax, [ebp+arg_14] ; [EBP+1Ch]=1
        mov     ecx, TlsIndex    ; [69AEB08h]=0
        mov     edx, large fs:2Ch
        mov     edx, [edx+ecx*4] ; [EDX+ECX*4]=0xc98c938

```

<sup>39</sup>[yurichev.com](http://yurichev.com)

```

    cmp     eax, 2           ; EAX=1
    mov     eax, [ebp+arg_8] ; [EBP+10h]=0xcdfe554
    jz      loc_2CE1288
    mov     ecx, [eax]      ; [EAX]=0..5
    mov     [ebp+var_4], edi ; EDI=0xc98c938

loc_2CE10F6: ; CODE XREF: _kqvrow_+10A
             ; _kqvrow_+1A9
    cmp     ecx, 5         ; ECX=0..5
    ja      loc_56C11C7
    mov     edi, [ebp+arg_18] ; [EBP+20h]=0
    mov     [ebp+var_14], edx ; EDX=0xc98c938
    mov     [ebp+var_8], ebx ; EBX=0
    mov     ebx, eax       ; EAX=0xcdfe554
    mov     [ebp+var_C], esi ; ESI=0xcdfe248

loc_2CE110D: ; CODE XREF: _kqvrow_+29E00E6
    mov     edx, ds:off_628B09C[ecx*4] ; [ECX*4+628B09Ch]=0x2ce1116, 0x2ce11ac, 0x2ce11db,
0x2ce11f6, 0x2ce1236, 0x2ce127a
    jmp     edx             ; EDX=0x2ce1116, 0x2ce11ac, 0x2ce11db, 0x2ce11f6, 0x2ce1236,
0x2ce127a

loc_2CE1116: ; DATA XREF: .rdata:off_628B09C
    push   offset aXKqvvsnBuffer ; "x$kqvvsn buffer"
    mov     ecx, [ebp+arg_C] ; [EBP+14h]=0x8a172b4
    xor     edx, edx
    mov     esi, [ebp+var_14] ; [EBP-14h]=0xc98c938
    push   edx             ; EDX=0
    push   edx             ; EDX=0
    push   50h
    push   ecx             ; ECX=0x8a172b4
    push   dword ptr [esi+10494h] ; [ESI+10494h]=0xc98cd58
    call   _kghalf        ; tracing nested maximum level (1) reached, skipping this CALL
    mov     esi, ds:__imp__vsnum ; [59771A8h]=0x61bc49e0
    mov     [ebp+Dest], eax ; EAX=0xce2ffb0
    mov     [ebx+8], eax   ; EAX=0xce2ffb0
    mov     [ebx+4], eax   ; EAX=0xce2ffb0
    mov     edi, [esi]     ; [ESI]=0xb200100
    mov     esi, ds:__imp__vsnstr ; [597D6D4h]=0x65852148, "- Production"
    push   esi             ; ESI=0x65852148, "- Production"
    mov     ebx, edi       ; EDI=0xb200100
    shr     ebx, 18h       ; EBX=0xb200100
    mov     ecx, edi       ; EDI=0xb200100
    shr     ecx, 14h       ; ECX=0xb200100
    and     ecx, 0Fh       ; ECX=0xb2
    mov     edx, edi       ; EDI=0xb200100
    shr     edx, 0Ch       ; EDX=0xb200100
    movzx  edx, dl         ; DL=0
    mov     eax, edi       ; EDI=0xb200100
    shr     eax, 8         ; EAX=0xb200100
    and     eax, 0Fh       ; EAX=0xb2001
    and     edi, 0FFh      ; EDI=0xb200100
    push   edi             ; EDI=0
    mov     edi, [ebp+arg_18] ; [EBP+20h]=0
    push   eax             ; EAX=1
    mov     eax, ds:__imp__vsnbans ;
[597D6D8h]=0x65852100, "Oracle Database 11g Enterprise Edition Release %d.%d.%d.%d.%d %s"
    push   edx             ; EDX=0
    push   ecx             ; ECX=2
    push   ebx             ; EBX=0xb
    mov     ebx, [ebp+arg_8] ; [EBP+10h]=0xcdfe554
    push   eax             ;
EAX=0x65852100, "Oracle Database 11g Enterprise Edition Release %d.%d.%d.%d.%d %s"
    mov     eax, [ebp+Dest] ; [EBP-10h]=0xce2ffb0
    push   eax             ; EAX=0xce2ffb0
    call   ds:__imp__sprintf ; opl=MSVCR80.dll!sprintf tracing nested maximum level (1)
reached, skipping this CALL
    add     esp, 38h
    mov     dword ptr [ebx], 1

loc_2CE1192: ; CODE XREF: _kqvrow_+FB

```

```

    ; _kqvrow_+128 ...
    test    edi, edi        ; EDI=0
    jnz     __VInfreq_kqvrow
    mov     esi, [ebp+var_C] ; [EBP-0Ch]=0xcdfe248
    mov     edi, [ebp+var_4] ; [EBP-4]=0xc98c938
    mov     eax, ebx        ; EBX=0xcdfe554
    mov     ebx, [ebp+var_8] ; [EBP-8]=0
    lea     eax, [eax+4]    ; [EAX+4]=0xce2ffb0, "NLSRTL Version 11.2.0.1.0 - Production",
"Oracle Database 11g Enterprise Edition Release 11.2.0.1.0 - Production", "PL/SQL Release
11.2.0.1.0 - Production", "TNS for 32-bit Windows: Version 11.2.0.1.0 - Production"

```

```

loc_2CE11A8: ; CODE XREF: _kqvrow_+29E00F6
    mov     esp, ebp
    pop     ebp
    retn                                ; EAX=0xcdfe558

```

```

loc_2CE11AC: ; DATA XREF: .rdata:0628B0A0
    mov     edx, [ebx+8]      ; [EBX+8]=0xce2ffb0, "Oracle Database 11g Enterprise Edition
Release 11.2.0.1.0 - Production"
    mov     dword ptr [ebx], 2
    mov     [ebx+4], edx     ; EDX=0xce2ffb0, "Oracle Database 11g Enterprise Edition
Release 11.2.0.1.0 - Production"
    push    edx              ; EDX=0xce2ffb0, "Oracle Database 11g Enterprise Edition
Release 11.2.0.1.0 - Production"
    call    _kkxvsn         ; tracing nested maximum level (1) reached, skipping this CALL
    pop     ecx
    mov     edx, [ebx+4]     ; [EBX+4]=0xce2ffb0, "PL/SQL Release 11.2.0.1.0 - Production"
    movzx   ecx, byte ptr [edx] ; [EDX]=0x50
    test    ecx, ecx        ; ECX=0x50
    jnz     short loc_2CE1192
    mov     edx, [ebp+var_14]
    mov     esi, [ebp+var_C]
    mov     eax, ebx
    mov     ebx, [ebp+var_8]
    mov     ecx, [eax]
    jmp     loc_2CE10F6

```

```

loc_2CE11DB: ; DATA XREF: .rdata:0628B0A4
    push    0
    push    50h
    mov     edx, [ebx+8]     ; [EBX+8]=0xce2ffb0, "PL/SQL Release 11.2.0.1.0 - Production"
    mov     [ebx+4], edx     ; EDX=0xce2ffb0, "PL/SQL Release 11.2.0.1.0 - Production"
    push    edx              ; EDX=0xce2ffb0, "PL/SQL Release 11.2.0.1.0 - Production"
    call    _lmxver         ; tracing nested maximum level (1) reached, skipping this CALL
    add     esp, 0Ch
    mov     dword ptr [ebx], 3
    jmp     short loc_2CE1192

```

```

loc_2CE11F6: ; DATA XREF: .rdata:0628B0A8
    mov     edx, [ebx+8]     ; [EBX+8]=0xce2ffb0
    mov     [ebp+var_18], 50h
    mov     [ebx+4], edx     ; EDX=0xce2ffb0
    push    0
    call    _npinli         ; tracing nested maximum level (1) reached, skipping this CALL
    pop     ecx
    test    eax, eax        ; EAX=0
    jnz     loc_56C11DA
    mov     ecx, [ebp+var_14] ; [EBP-14h]=0xc98c938
    lea     edx, [ebp+var_18] ; [EBP-18h]=0x50
    push    edx              ; EDX=0xd76c93c
    push    dword ptr [ebx+8] ; [EBX+8]=0xce2ffb0
    push    dword ptr [ecx+13278h] ; [ECX+13278h]=0xacce190
    call    _nrtnsvrs       ; tracing nested maximum level (1) reached, skipping this CALL
    add     esp, 0Ch

```

```

loc_2CE122B: ; CODE XREF: _kqvrow_+29E0118
    mov     dword ptr [ebx], 4
    jmp     loc_2CE1192

```

```

loc_2CE1236: ; DATA XREF: .rdata:0628B0AC
    lea     edx, [ebp+var_7C] ; [EBP-7Ch]=1

```



```

    push    edx                ; EDX=0xd76c8d8
    push    0
    mov     esi, [ebx+8]      ; [EBX+8]=0xce2ffb0, "TNS for 32-bit Windows: Version
11.2.0.1.0 - Production"
    mov     [ebx+4], esi     ; ESI=0xce2ffb0, "TNS for 32-bit Windows: Version 11.2.0.1.0 -
Production"
    mov     ecx, 50h
    mov     [ebp+var_18], ecx ; ECX=0x50
    push    ecx                ; ECX=0x50
    push    esi                ; ESI=0xce2ffb0, "TNS for 32-bit Windows: Version 11.2.0.1.0 -
Production"
    call    _lxvers          ; tracing nested maximum level (1) reached, skipping this CALL
    add     esp, 10h
    mov     edx, [ebp+var_18] ; [EBP-18h]=0x50
    mov     dword ptr [ebx], 5
    test    edx, edx          ; EDX=0x50
    jnz     loc_2CE1192
    mov     edx, [ebp+var_14]
    mov     esi, [ebp+var_C]
    mov     eax, ebx
    mov     ebx, [ebp+var_8]
    mov     ecx, 5
    jmp     loc_2CE10F6

loc_2CE127A: ; DATA XREF: .rdata:0628B0B0
    mov     edx, [ebp+var_14] ; [EBP-14h]=0xc98c938
    mov     esi, [ebp+var_C] ; [EBP-0Ch]=0xcdfe248
    mov     edi, [ebp+var_4] ; [EBP-4]=0xc98c938
    mov     eax, ebx          ; EBX=0xcdfe554
    mov     ebx, [ebp+var_8] ; [EBP-8]=0

loc_2CE1288: ; CODE XREF: _kqvrow_+1F
    mov     eax, [eax+8]      ; [EAX+8]=0xce2ffb0, "NLSRTL Version 11.2.0.1.0 - Production"
    test    eax, eax          ; EAX=0xce2ffb0, "NLSRTL Version 11.2.0.1.0 - Production"
    jz     short loc_2CE12A7
    push    offset aXKqvvsnBuffer ; "x$kqvvsn buffer"
    push    eax                ; EAX=0xce2ffb0, "NLSRTL Version 11.2.0.1.0 - Production"
    mov     eax, [ebp+arg_C] ; [EBP+14h]=0x8a172b4
    push    eax                ; EAX=0x8a172b4
    push    dword ptr [edx+10494h] ; [EDX+10494h]=0xc98cd58
    call    _kghfrf          ; tracing nested maximum level (1) reached, skipping this CALL
    add     esp, 10h

loc_2CE12A7: ; CODE XREF: _kqvrow_+1C1
    xor     eax, eax
    mov     esp, ebp
    pop     ebp
    retn                                ; EAX=0
_kqvrow_ endp

```

Now it is easy to see that the row number is passed from outside. The function returns the string, constructing it as follows:

String 1	Using vsnstr, vsnnum, vsnban global variables. Calls sprintf().
String 2	Calls kkvvsn().
String 3	Calls lmxver().
String 4	Calls npinli(), nrtnsvrs().
String 5	Calls lxvers().

That's how the corresponding functions are called for determining each module's version.

### 8.13.2 X\$KSMLRU table in Oracle RDBMS

There is a mention of a special table in the *Diagnosing and Resolving Error ORA-04031 on the Shared Pool or Other Memory Pools [Video] [ID 146599.1]* note:

There is a fixed table called X\$KSMLRU that tracks allocations in the shared pool that

cause other objects in the shared pool to be aged out. This fixed table can be used to identify what is causing the large allocation.

If many objects are being periodically flushed from the shared pool then this will cause response time problems and will likely cause library cache latch contention problems when the objects are reloaded into the shared pool.

One unusual thing about the X\$KSMLRU fixed table is that the contents of the fixed table are erased whenever someone selects from the fixed table. This is done since the fixed table stores only the largest allocations that have occurred. The values are reset after being selected so that subsequent large allocations can be noted even if they were not quite as large as others that occurred previously. Because of this resetting, the output of selecting from this table should be carefully kept since it cannot be retrieved back after the query is issued.

However, as it can be easily checked, the contents of this table are cleared each time it's queried. Are we able to find why? Let's get back to tables we already know: kqftab and kqftap which were generated with oracle tables<sup>40</sup>'s help, that has all information about the X\$-tables. We can see here that the ksm\_lrs() function is called to prepare this table's elements:

Listing 8.19: Result of oracle tables

```
kqftab_element.name: [X$KSMLRU] ?: [ksmlr] 0x4 0x64 0x11 0xc 0xffffc0bb 0x5
kqftap_param.name=[ADDR] ?: 0x917 0x0 0x0 0x0 0x4 0x0 0x0
kqftap_param.name=[INDX] ?: 0xb02 0x0 0x0 0x0 0x4 0x0 0x0
kqftap_param.name=[INST_ID] ?: 0xb02 0x0 0x0 0x0 0x4 0x0 0x0
kqftap_param.name=[KSMLRIDX] ?: 0xb02 0x0 0x0 0x0 0x4 0x0 0x0
kqftap_param.name=[KSMLRDUR] ?: 0xb02 0x0 0x0 0x0 0x4 0x4 0x0
kqftap_param.name=[KSMLRSHRPOOL] ?: 0xb02 0x0 0x0 0x0 0x4 0x8 0x0
kqftap_param.name=[KSMLRCOM] ?: 0x501 0x0 0x0 0x0 0x14 0xc 0x0
kqftap_param.name=[KSMLRSIZ] ?: 0x2 0x0 0x0 0x0 0x4 0x20 0x0
kqftap_param.name=[KSMLRNUM] ?: 0x2 0x0 0x0 0x0 0x4 0x24 0x0
kqftap_param.name=[KSMLRHON] ?: 0x501 0x0 0x0 0x0 0x20 0x28 0x0
kqftap_param.name=[KSMLROHV] ?: 0xb02 0x0 0x0 0x0 0x4 0x48 0x0
kqftap_param.name=[KSMLRSES] ?: 0x17 0x0 0x0 0x0 0x4 0x4c 0x0
kqftap_param.name=[KSMLRADU] ?: 0x2 0x0 0x0 0x0 0x4 0x50 0x0
kqftap_param.name=[KSMLRNID] ?: 0x2 0x0 0x0 0x0 0x4 0x54 0x0
kqftap_param.name=[KSMLRNSD] ?: 0x2 0x0 0x0 0x0 0x4 0x58 0x0
kqftap_param.name=[KSMLRNCD] ?: 0x2 0x0 0x0 0x0 0x4 0x5c 0x0
kqftap_param.name=[KSMLRNED] ?: 0x2 0x0 0x0 0x0 0x4 0x60 0x0
kqftap_element.fn1=ksmlrs
kqftap_element.fn2=NULL
```

Indeed, with tracer's help it is easy to see that this function is called each time we query the X\$KSMLRU table.

Here we see a references to the ksm\_splu\_sp() and ksm\_splu\_jp() functions, each of them calls the ksm\_splu() at the end. At the end of the ksm\_splu() function we see a call to memset():

Listing 8.20: ksm.o

```
...
.text:00434C50 loc_434C50: ; DATA XREF: .rdata:off_5E50EA8
.text:00434C50 mov     edx, [ebp-4]
.text:00434C53 mov     [eax], esi
.text:00434C55 mov     esi, [edi]
.text:00434C57 mov     [eax+4], esi
.text:00434C5A mov     [edi], eax
.text:00434C5C add     edx, 1
.text:00434C5F mov     [ebp-4], edx
.text:00434C62 jnz    loc_434B7D
.text:00434C68 mov     ecx, [ebp+14h]
.text:00434C6B mov     ebx, [ebp-10h]
.text:00434C6E mov     esi, [ebp-0Ch]
.text:00434C71 mov     edi, [ebp-8]
```

<sup>40</sup>yurichev.com

```
.text:00434C74      lea    eax, [ecx+8Ch]
.text:00434C7A      push   370h          ; Size
.text:00434C7F      push   0             ; Val
.text:00434C81      push   eax           ; Dst
.text:00434C82      call   __intel_fast_memset
.text:00434C87      add    esp, 0Ch
.text:00434C8A      mov    esp, ebp
.text:00434C8C      pop    ebp
.text:00434C8D      retn
.text:00434C8D _ksmsplu endp
```

Constructions like `memset (block, 0, size)` are often used just to zero memory block. What if we take a risk, block the `memset()` call and see what happens?

Let's run `tracer` with the following options: set breakpoint at `0x434C7A` (the point where the arguments to `memset()` are to be passed), so that `tracer` will set program counter EIP to the point where the arguments passed to `memset()` are to be cleared (at `0x434C8A`) It can be said that we just simulate an unconditional jump from address `0x434C7A` to `0x434C8A`.

```
tracer -a:oracle.exe bpx=oracle.exe!0x00434C7A,set(eip,0x00434C8A)
```

(Important: all these addresses are valid only for the win32 version of Oracle RDBMS 11.2)

Indeed, now we can query the `X$KSMRLU` table as many times as we want and it is not being cleared anymore!

Just in case, do not try this on your production servers.

It is probably not a very useful or desired system behavior, but as an experiment for locating a piece of code that we need, it perfectly suits our needs!

### 8.13.3 V\$TIMER table in Oracle RDBMS

`V$TIMER` is another *fixed view* that reflects a rapidly changing value:

`V$TIMER` displays the elapsed time in hundredths of a second. Time is measured since the beginning of the epoch, which is operating system specific, and wraps around to 0 again whenever the value overflows four bytes (roughly 497 days).

(From Oracle RDBMS documentation <sup>41</sup>)

It is interesting that the periods are different for Oracle for win32 and for Linux. Will we be able to find the function that generates this value?

As we can see, this information is finally taken from the `X$KSUTM` table.

```
SQL> select * from V$FIXED_VIEW_DEFINITION where view_name='V$TIMER';

VIEW_NAME
-----
VIEW_DEFINITION
-----

V$TIMER
select  HSECS from GV$TIMER where inst_id = USERENV('Instance')

SQL> select * from V$FIXED_VIEW_DEFINITION where view_name='GV$TIMER';

VIEW_NAME
-----
VIEW_DEFINITION
-----

GV$TIMER
```

<sup>41</sup><http://go.yurichev.com/17088>

```
select inst_id,ksutmtim from x$ksutm
```

Now we are stuck in a small problem, there are no references to value generating function(s) in the tables kqftab/kqftap:

Listing 8.21: Result of oracle tables

```
kqftab_element.name: [X$KSUTM] ?: [ksutm] 0x1 0x4 0x4 0x0 0xffffc09b 0x3
kqftap_param.name=[ADDR] ?: 0x10917 0x0 0x0 0x0 0x4 0x0 0x0
kqftap_param.name=[INDX] ?: 0x20b02 0x0 0x0 0x0 0x4 0x0 0x0
kqftap_param.name=[INST_ID] ?: 0xb02 0x0 0x0 0x0 0x4 0x0 0x0
kqftap_param.name=[KSUTMTIM] ?: 0x1302 0x0 0x0 0x0 0x4 0x0 0x1e
kqftap_element.fn1=NULL
kqftap_element.fn2=NULL
```

When we try to find the string KSUTMTIM, we see it in this function:

```
kqfd_DRN_ksutm_c proc near      ; DATA XREF: .rodata:0805B4E8
arg_0    = dword ptr  8
arg_8    = dword ptr  10h
arg_C    = dword ptr  14h

        push    ebp
        mov     ebp, esp
        push   [ebp+arg_C]
        push   offset ksugtm
        push   offset _2_STRING_1263_0 ; "KSUTMTIM"
        push   [ebp+arg_8]
        push   [ebp+arg_0]
        call   kqfd_cfui_drain
        add    esp, 14h
        mov    esp, ebp
        pop    ebp
        retn
kqfd_DRN_ksutm_c endp
```

The kqfd\_DRN\_ksutm\_c() function is mentioned in the kqfd\_tab\_registry\_0 table:

```
dd offset _2_STRING_62_0 ; "X$KSUTM"
dd offset kqfd_OPN_ksutm_c
dd offset kqfd_tabl_fetch
dd 0
dd 0
dd offset kqfd_DRN_ksutm_c
```

There is a function ksugtm() referenced here. Let's see what's in it (Linux x86):

Listing 8.22: ksu.o

```
ksugtm proc near
var_1C   = byte ptr  -1Ch
arg_4    = dword ptr  0Ch

        push    ebp
        mov     ebp, esp
        sub    esp, 1Ch
        lea    eax, [ebp+var_1C]
        push   eax
        call   slgcs
        pop    ecx
        mov    edx, [ebp+arg_4]
```

```

    mov     [edx], eax
    mov     eax, 4
    mov     esp, ebp
    pop     ebp
    retn
ksugtm endp

```

The code in the win32 version is almost the same.

Is this the function we are looking for? Let's see:

```
tracer -a:oracle.exe bpf=oracle.exe!_ksugtm,args:2,dump_args:0x4
```

Let's try again:

```

SQL> select * from V$TIMER;

      HSECS
-----
27294929

SQL> select * from V$TIMER;

      HSECS
-----
27295006

SQL> select * from V$TIMER;

      HSECS
-----
27295167

```

Listing 8.23: [tracer](#) output

```

TID=2428|(0) oracle.exe!_ksugtm (0x0, 0xd76c5f0) (called from oracle.exe!__VInfreq__qerfxFetch
  ↳ +0xfad (0x56bb6d5))
Argument 2/2
0D76C5F0: 38 C9                                "8."
TID=2428|(0) oracle.exe!_ksugtm () -> 0x4 (0x4)
Argument 2/2 difference
00000000: D1 7C A0 01                                ".|.."
TID=2428|(0) oracle.exe!_ksugtm (0x0, 0xd76c5f0) (called from oracle.exe!__VInfreq__qerfxFetch
  ↳ +0xfad (0x56bb6d5))
Argument 2/2
0D76C5F0: 38 C9                                "8."
TID=2428|(0) oracle.exe!_ksugtm () -> 0x4 (0x4)
Argument 2/2 difference
00000000: 1E 7D A0 01                                ".}.."
TID=2428|(0) oracle.exe!_ksugtm (0x0, 0xd76c5f0) (called from oracle.exe!__VInfreq__qerfxFetch
  ↳ +0xfad (0x56bb6d5))
Argument 2/2
0D76C5F0: 38 C9                                "8."
TID=2428|(0) oracle.exe!_ksugtm () -> 0x4 (0x4)
Argument 2/2 difference
00000000: BF 7D A0 01                                ".}.."

```

Indeed—the value is the same we see in SQL\*Plus and it is returned via the second argument.

Let's see what is in `slgcs()` (Linux x86):

```

slgcs  proc near
var_4  = dword ptr -4

```

```

arg_0 = dword ptr 8

    push    ebp
    mov     ebp, esp
    push    esi
    mov     [ebp+var_4], ebx
    mov     eax, [ebp+arg_0]
    call    $+5
    pop     ebx
    nop
    mov     ebx, offset _GLOBAL_OFFSET_TABLE_
    mov     dword ptr [eax], 0
    call    sltrgatime64 ; PIC mode
    push    0
    push    0Ah
    push    edx
    push    eax
    call    __udivdi3 ; PIC mode
    mov     ebx, [ebp+var_4]
    add     esp, 10h
    mov     esp, ebp
    pop     ebp
    retn
_slgcs endp

```

(it is just a call to `sltrgatime64()`  
and division of its result by 10 ( [3.12 on page 500](#)))  
And win32-version:

```

_slgcs proc near ; CODE XREF: _dbgefgHtElResetCount+15
; _dbgerRunActions+1528
    db     66h
    nop
    push   ebp
    mov    ebp, esp
    mov    eax, [ebp+8]
    mov    dword ptr [eax], 0
    call  ds:__imp_GetTickCount@0 ; GetTickCount()
    mov    edx, eax
    mov    eax, 0CCCCCDh
    mul   edx
    shr   edx, 3
    mov    eax, edx
    mov    esp, ebp
    pop   ebp
    retn
_slgcs endp

```

It is just the result of `GetTickCount()`<sup>42</sup> divided by 10 ( [3.12 on page 500](#)).

Voilà! That's why the win32 version and the Linux x86 version show different results, because they are generated by different [OS](#) functions.

*Drain* apparently implies *connecting* a specific table column to a specific function.

We will add support of the table `kqfd_tab_registry_0` to oracle tables<sup>43</sup>, now we can see how the table column's variables are *connected* to a specific functions:

```

[X$KSUTM] [kqfd_OPN_ksutm_c] [kqfd_tabl_fetch] [NULL] [NULL] [kqfd_DRN_ksutm_c]
[X$KSUSGIF] [kqfd_OPN_ksusg_c] [kqfd_tabl_fetch] [NULL] [NULL] [kqfd_DRN_ksusg_c]

```

*OPN*, apparently stands for, *open*, and *DRN*, apparently, for *drain*.

<sup>42</sup>MSDN

<sup>43</sup>yurichev.com

## 8.14 Handwritten assembly code

### 8.14.1 EICAR test file

This .COM-file is intended for testing antivirus software, it is possible to run in in MS-DOS and it prints this string: “EICAR-STANDARD-ANTIVIRUS-TEST-FILE!”.

Its important property is that it consists entirely of printable ASCII-symbols, which, in turn, makes it possible to create it in any text editor:

```
X50!P%@AP[4\PZX54(P^)7CC)7}$EICAR-STANDARD-ANTIVIRUS-TEST-FILE!$H+H*
```

Let's decompile it:

```
; initial conditions: SP=0FFFEh, SS:[SP]=0
0100 58          pop     ax
; AX=0, SP=0
0101 35 4F 21    xor     ax, 214Fh
; AX = 214Fh and SP = 0
0104 50          push    ax
; AX = 214Fh, SP = FFFEh and SS:[FFFE] = 214Fh
0105 25 40 41    and     ax, 4140h
; AX = 140h, SP = FFFEh and SS:[FFFE] = 214Fh
0108 50          push    ax
; AX = 140h, SP = FFFCh, SS:[FFFC] = 140h and SS:[FFFE] = 214Fh
0109 5B          pop     bx
; AX = 140h, BX = 140h, SP = FFFEh and SS:[FFFE] = 214Fh
010A 34 5C        xor     al, 5Ch
; AX = 11Ch, BX = 140h, SP = FFFEh and SS:[FFFE] = 214Fh
010C 50          push    ax
010D 5A          pop     dx
; AX = 11Ch, BX = 140h, DX = 11Ch, SP = FFFEh and SS:[FFFE] = 214Fh
010E 58          pop     ax
; AX = 214Fh, BX = 140h, DX = 11Ch and SP = 0
010F 35 34 28    xor     ax, 2834h
; AX = 97Bh, BX = 140h, DX = 11Ch and SP = 0
0112 50          push    ax
0113 5E          pop     si
; AX = 97Bh, BX = 140h, DX = 11Ch, SI = 97Bh and SP = 0
0114 29 37        sub     [bx], si
0116 43          inc     bx
0117 43          inc     bx
0118 29 37        sub     [bx], si
011A 7D 24        jge     short near ptr word_10140
011C 45 49 43 ...  db 'EICAR-STANDARD-ANTIVIRUS-TEST-FILE!$'
0140 48 2B        word_10140 dw 2B48h ; CD 21 (INT 21) will be here
0142 48 2A        dw 2A48h ; CD 20 (INT 20) will be here
0144 0D          db 0Dh
0145 0A          db 0Ah
```

We will add comments about the registers and stack after each instruction.

Essentially, all these instructions are here only to execute this code:

```
B4 09      MOV AH, 9
BA 1C 01   MOV DX, 11Ch
CD 21      INT 21h
CD 20      INT 20h
```

INT 21h with 9th function (passed in AH) just prints a string, the address of which is passed in DS:DX. By the way, the string has to be terminated with the '\$' sign. Apparently, it's inherited from CP/M and this function was left in DOS for compatibility. INT 20h exits to DOS.

But as we can see, these instruction's opcodes are not strictly printable. So the main part of EICAR file is:

- preparing the register (AH and DX) values that we need;
- preparing INT 21 and INT 20 opcodes in memory;

- executing INT 21 and INT 20.

By the way, this technique is widely used in shellcode construction, when one have to pass x86 code in string form.

Here is also a list of all x86 instructions which have printable opcodes: [.1.6 on page 1038](#).

## 8.15 Demos

Demos (or demomaking) were an excellent exercise in mathematics, computer graphics programming and very tight x86 hand coding.

### 8.15.1 10 PRINT CHR\$(205.5+RND(1)); : GOTO 10

All examples here are MS-DOS .COM files.

In [Nick Montfort et al, *10 PRINT CHR\$(205.5+RND(1)); : GOTO 10*, (The MIT Press:2012)] <sup>44</sup>

we can read about one of the most simple possible random maze generators.

It just prints a slash or backslash characters randomly and endlessly, resulting in something like this:

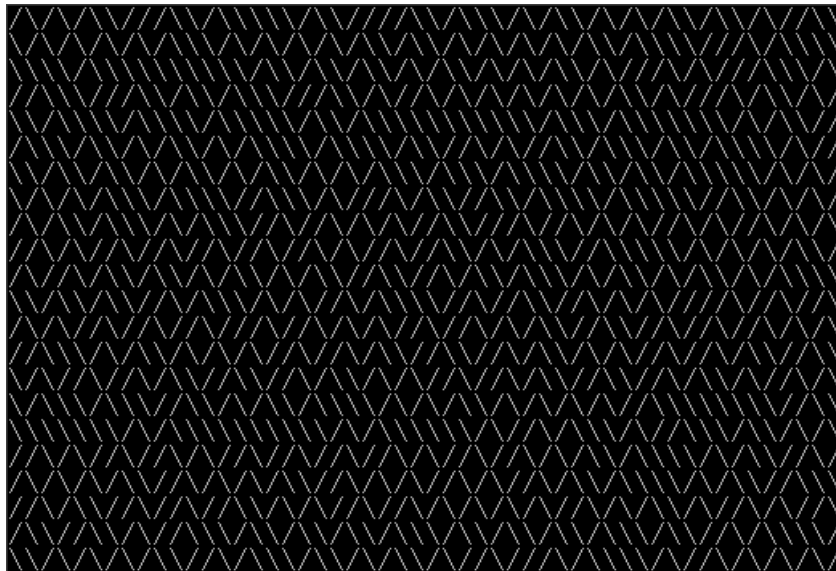

There are a few known implementations for 16-bit x86.

#### Trixter's 42 byte version

The listing was taken from his website<sup>45</sup>, but the comments are mine.

```

00000000: B001      mov     al,1      ; set 40x25 video mode
00000002: CD10      int     010
00000004: 30FF      xor     bh,bh     ; set video page for int 10h call
00000006: B9D007    mov     cx,007D0 ; 2000 characters to output
00000009: 31C0      xor     ax,ax
0000000B: 9C        pushf           ; push flags
; get random value from timer chip
0000000C: FA        cli             ; disable interrupts
0000000D: E643      out     043,al   ; write 0 to port 43h
; read 16-bit value from port 40h
0000000F: E440      in     al,040
00000011: 88C4      mov     ah,al
00000013: E440      in     al,040
00000015: 9D        popf           ; enable interrupts by restoring IF flag
00000016: 86C4      xchg   ah,al
; here we have 16-bit pseudorandom value
00000018: D1E8      shr     ax,1

```

<sup>44</sup>Also available as <http://go.yurichev.com/17286>

<sup>45</sup><http://go.yurichev.com/17305>



```

0000001A: D1E8      shr     ax,1
; CF currently have second bit from the value
0000001C: B05C      mov     al,05C ;'
; if CF=1, skip the next instruction
0000001E: 7202      jc     00000022
; if CF=0, reload AL register with another character
00000020: B02F      mov     al,02F ;'/'
; output character
00000022: B40E      mov     ah,00E
00000024: CD10      int     010
00000026: E2E1      loop   00000009 ; loop 2000 times
00000028: CD20      int     020      ; exit to DOS

```

The pseudo-random value here is in fact the time that has passed from the system's boot, taken from the 8253 time chip, the value increases by one 18.2 times per second.

By writing zero to port 43h, we send the command "select counter 0", "counter latch", "binary counter" (not a BCD value).

The interrupts are enabled back with the POPF instruction, which restores the IF flag as well.

It is not possible to use the IN instruction with registers other than AL, hence the shuffling.

### My attempt to reduce Trixter's version: 27 bytes

We can say that since we use the timer not to get a precise time value, but a pseudo-random one, we do not need to spend time (and code) to disable the interrupts.

Another thing we can say is that we need only one bit from the low 8-bit part, so let's read only it.

We can reduced the code slightly and we've got 27 bytes:

```

00000000: B9D007  mov     cx,007D0 ; limit output to 2000 characters
00000003: 31C0    xor     ax,ax      ; command to timer chip
00000005: E643    out     043,al
00000007: E440    in     al,040     ; read 8-bit of timer
00000009: D1E8    shr     ax,1      ; get second bit to CF flag
0000000B: D1E8    shr     ax,1
0000000D: B05C    mov     al,05C    ; prepare '\'
0000000F: 7202    jc     00000013
00000011: B02F    mov     al,02F    ; prepare '/'
; output character to screen
00000013: B40E    mov     ah,00E
00000015: CD10    int     010
00000017: E2EA    loop   00000003
; exit to DOS
00000019: CD20    int     020

```

### Taking random memory garbage as a source of randomness

Since it is MS-DOS, there is no memory protection at all, we can read from whatever address we want. Even more than that: a simple LODSB instruction reads a byte from the DS:SI address, but it's not a problem if the registers' values are not set up, let it read 1) random bytes; 2) from a random place in memory!

It is suggested in Trixter's webpage<sup>46</sup> to use LODSB without any setup.

It is also suggested that the SCASB instruction can be used instead, because it sets a flag according to the byte it reads.

Another idea to minimize the code is to use the INT 29h DOS syscall, which just prints the character stored in the AL register.

That is what Peter Ferrie did<sup>47</sup>:

Listing 8.24: Peter Ferrie: 10 bytes

```

; AL is random at this point
00000000: AE      scasb

```

<sup>46</sup><http://go.yurichev.com/17305>

<sup>47</sup><http://go.yurichev.com/17087>

```

; CF is set according subtracting random memory byte from AL.
; so it is somewhat random at this point
00000001: D6          setalc
; AL is set to 0xFF if CF=1 or to 0 if otherwise
00000002: 242D         and          al,02D ;'-'
; AL here is 0x2D or 0
00000004: 042F         add          al,02F ;'/'
; AL here is 0x5C or 0x2F
00000006: CD29         int          029      ; output AL to screen
00000008: EBF6         jmps         00000000 ; loop endlessly

```

So it is possible to get rid of conditional jumps at all. The [ASCII](#) code of backslash (“\”) is 0x5C and 0x2F for slash (“/”). So we have to convert one (pseudo-random) bit in the CF flag to a value of 0x5C or 0x2F.

This is done easily: by AND-ing all bits in AL (where all 8 bits are set or cleared) with 0x2D we have just 0 or 0x2D.

By adding 0x2F to this value, we get 0x5C or 0x2F.

Then we just output it to the screen.

## Conclusion

It is also worth mentioning that the result may be different in DOSBox, [Windows NT](#) and even MS-DOS, due to different conditions: the timer chip can be emulated differently and the initial register contents may be different as well.

## 8.15.2 Mandelbrot set

You know, if you magnify the coastline, it still looks like a coastline, and a lot of other things have this property. Nature has recursive algorithms that it uses to generate clouds and Swiss cheese and things like that.

Donald Knuth, interview (1993)

Mandelbrot set is a fractal, which exhibits self-similarity.

When you increase scale, you see that this characteristic pattern repeating infinitely.

Here is a demo<sup>48</sup> written by “Sir\_Lagsalot” in 2009, that draws the Mandelbrot set, which is just a x86 program with executable file size of only 64 bytes. There are only 30 16-bit x86 instructions.

Here it is what it draws:

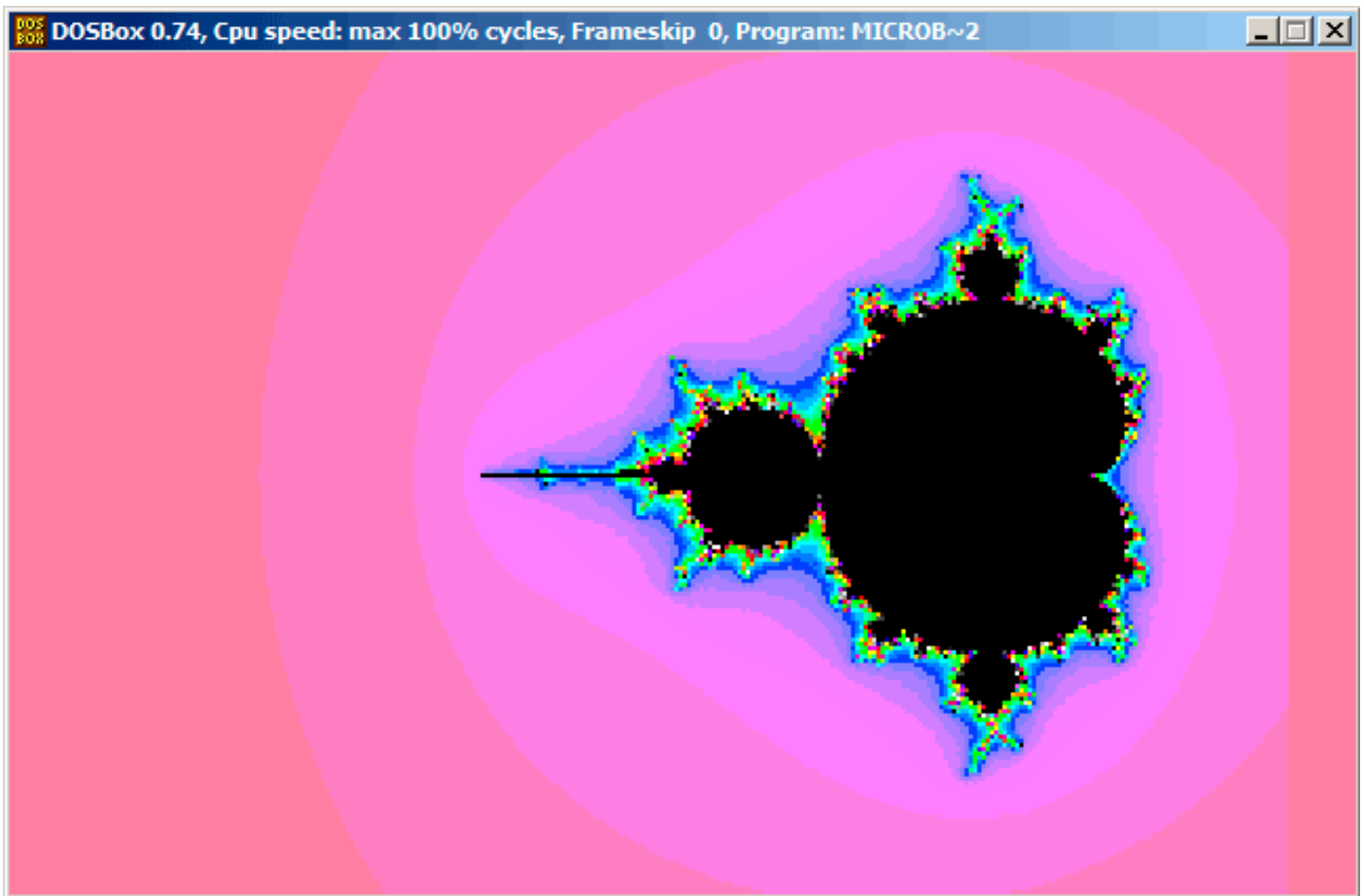

Let's try to understand how it works.

### Theory

#### A word about complex numbers

A complex number is a number that consists of two parts—real (Re) and imaginary (Im).

The complex plane is a two-dimensional plane where any complex number can be placed: the real part is one coordinate and the imaginary part is the other.

Some basic rules we have to keep in mind:

- Addition:  $(a + bi) + (c + di) = (a + c) + (b + d)i$

In other words:

$$\text{Re}(\text{sum}) = \text{Re}(a) + \text{Re}(b)$$

<sup>48</sup>Download it [here](#),

$$\text{Im}(\text{sum}) = \text{Im}(a) + \text{Im}(b)$$

- **Multiplication:**  $(a + bi)(c + di) = (ac - bd) + (bc + ad)i$

In other words:

$$\text{Re}(\text{product}) = \text{Re}(a) \cdot \text{Re}(c) - \text{Re}(b) \cdot \text{Re}(d)$$

$$\text{Im}(\text{product}) = \text{Im}(b) \cdot \text{Im}(c) + \text{Im}(a) \cdot \text{Im}(d)$$

- **Square:**  $(a + bi)^2 = (a + bi)(a + bi) = (a^2 - b^2) + (2ab)i$

In other words:

$$\text{Re}(\text{square}) = \text{Re}(a)^2 - \text{Im}(a)^2$$

$$\text{Im}(\text{square}) = 2 \cdot \text{Re}(a) \cdot \text{Im}(a)$$

## How to draw the Mandelbrot set

The Mandelbrot set is a set of points for which the  $z_{n+1} = z_n^2 + c$  recursive sequence (where  $z$  and  $c$  are complex numbers and  $c$  is the starting value) does not approach infinity.

In plain English language:

- Enumerate all points on screen.
- Check if the specific point is in the Mandelbrot set.
- Here is how to check it:
  - Represent the point as a complex number.
  - Calculate the square of it.
  - Add the starting value of the point to it.
  - Does it go off limits? If yes, break.
  - Move the point to the new place at the coordinates we just calculated.
  - Repeat all this for some reasonable number of iterations.
- The point is still in limits? Then draw the point.
- The point has eventually gone off limits?
  - (For a black-white image) do not draw anything.
  - (For a colored image) transform the number of iterations to some color. So the color shows the speed with which point has gone off limits.

Here is Pythonesque algorithm for both complex and integer number representations:

Listing 8.25: For complex numbers

```
def check_if_is_in_set(P):
    P_start=P
    iterations=0

    while True:
        if (P>bounds):
            break
        P=P^2+P_start
        if iterations > max_iterations:
            break
        iterations++

    return iterations

# black-white
for each point on screen P:
    if check_if_is_in_set (P) < max_iterations:
        draw point

# colored
for each point on screen P:
```

```
iterations = if check_if_is_in_set (P)
map iterations to color
draw color point
```

The integer version is where the operations on complex numbers are replaced with integer operations according to the rules which were explained above.

Listing 8.26: For integer numbers

```
def check_if_is_in_set(X, Y):
  X_start=X
  Y_start=Y
  iterations=0

  while True:
    if (X^2 + Y^2 > bounds):
      break
    new_X=X^2 - Y^2 + X_start
    new_Y=2*X*Y + Y_start
    if iterations > max_iterations:
      break
    iterations++

  return iterations

# black-white
for X = min_X to max_X:
  for Y = min_Y to max_Y:
    if check_if_is_in_set (X,Y) < max_iterations:
      draw point at X, Y

# colored
for X = min_X to max_X:
  for Y = min_Y to max_Y:
    iterations = if check_if_is_in_set (X,Y)
    map iterations to color
    draw color point at X,Y
```

Here is also a C# source which is present in the Wikipedia article<sup>49</sup>, but we'll modify it so it will print the iteration numbers instead of some symbol<sup>50</sup>:

```
using System;
using System.Collections.Generic;
using System.Linq;
using System.Text;

namespace Mnoj
{
  class Program
  {
    static void Main(string[] args)
    {
      double realCoord, imagCoord;
      double realTemp, imagTemp, realTemp2, arg;
      int iterations;
      for (imagCoord = 1.2; imagCoord >= -1.2; imagCoord -= 0.05)
      {
        for (realCoord = -0.6; realCoord <= 1.77; realCoord += 0.03)
        {
          iterations = 0;
          realTemp = realCoord;
          imagTemp = imagCoord;
          arg = (realCoord * realCoord) + (imagCoord * imagCoord);
          while ((arg < 2*2) && (iterations < 40))
          {
            realTemp2 = (realTemp * realTemp) - (imagTemp * imagTemp) - realCoord;
            imagTemp = (2 * realTemp * imagTemp) - imagCoord;
```

<sup>49</sup>[wikipedia](#)

<sup>50</sup>Here is also the executable file: [beginners.re](#)



There is a cool demo available at <http://go.yurichev.com/17309>, which shows visually how the point moves on the plane at each iteration for some specific point. Here are two screenshots.

First, we've clicked inside the yellow area and saw that the trajectory (green line) eventually swirls at some point inside:

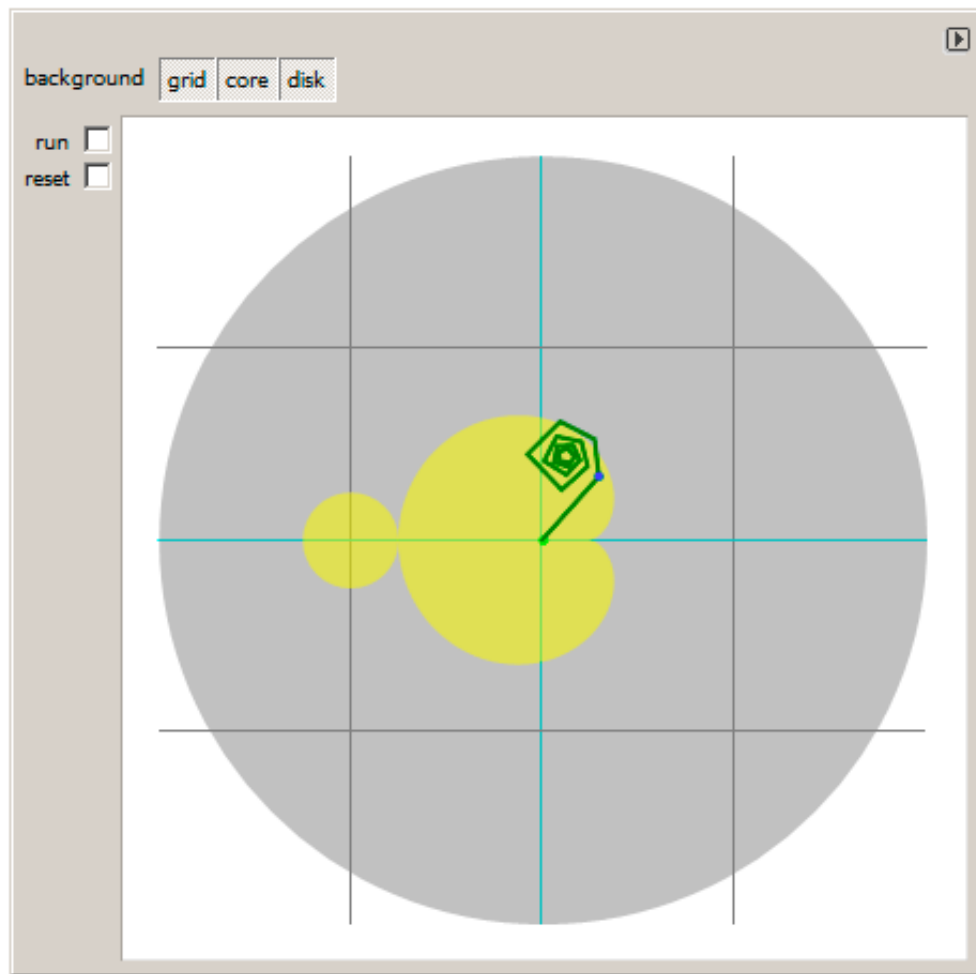

Figure 8.18: Click inside yellow area

This implies that the point we've clicked belongs to the Mandelbrot set.

Then we've clicked outside the yellow area and saw a much more chaotic point movement, which quickly went off bounds:

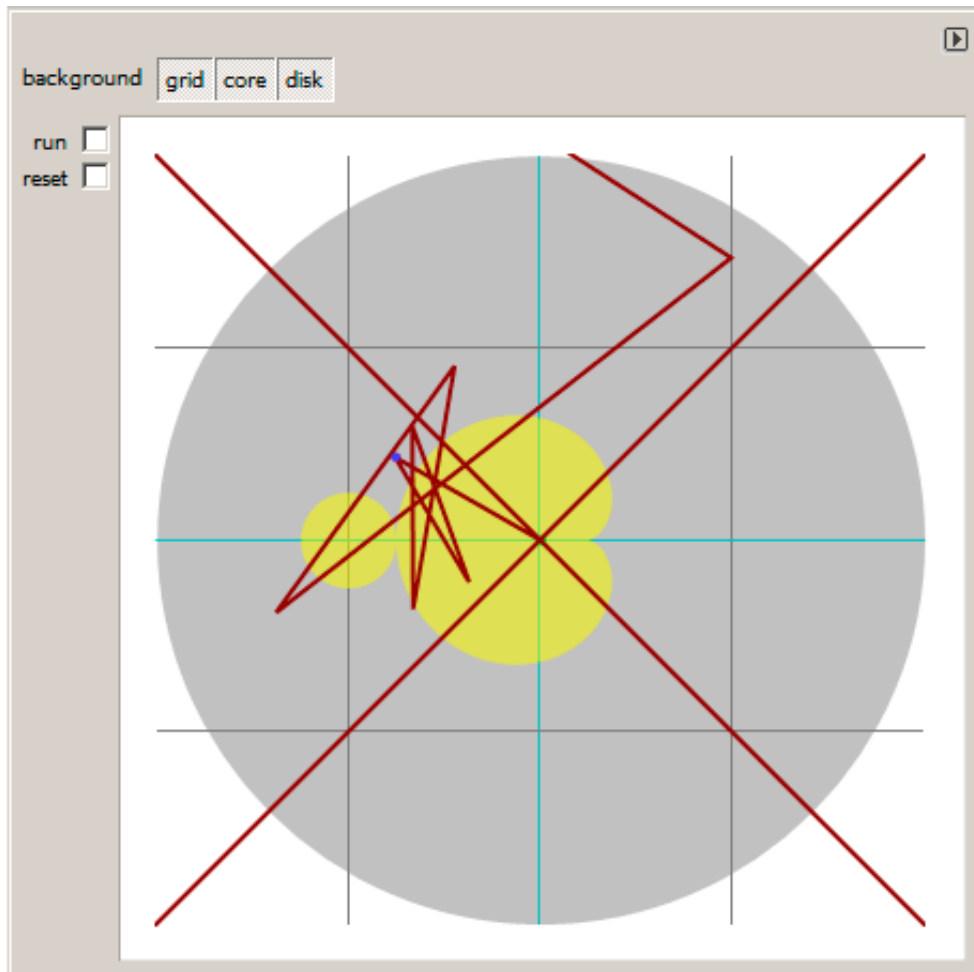

Figure 8.19: Click outside yellow area

This means the point doesn't belong to Mandelbrot set.

Another good demo is available here: <http://go.yurichev.com/17310>.



## Let's get back to the demo

The demo, although very tiny (just 64 bytes or 30 instructions), implements the common algorithm described here, but using some coding tricks.

The source code is easily downloadable, so here is it, but let's also add comments:

Listing 8.27: Commented source code

```
1 ; X is column on screen
2 ; Y is row on screen
3
4
5 ; X=0, Y=0 X=319, Y=0
6 ; +----->
7 ; |
8 ; |
9 ; |
10 ; |
11 ; |
12 ; |
13 ; v
14 ; X=0, Y=199 X=319, Y=199
15
16
17 ; switch to VGA 320*200*256 graphics mode
18 mov al,13h
19 int 10h
20 ; initial BX is 0
21 ; initial DI is 0xFFFFE
22 ; DS:BX (or DS:0) is pointing to Program Segment Prefix at this moment
23 ; ... first 4 bytes of which are CD 20 FF 9F
24 les ax,[bx]
25 ; ES:AX=9FFF:20CD
26
27 FillLoop:
28 ; set DX to 0. CWD works as: DX:AX = sign_extend(AX).
29 ; AX here 0x20CD (at startup) or less then 320 (when getting back after loop),
30 ; so DX will always be 0.
31 cwd
32 mov ax,di
33 ; AX is current pointer within VGA buffer
34 ; divide current pointer by 320
35 mov cx,320
36 div cx
37 ; DX (start_X) - remainder (column: 0..319); AX - result (row: 0..199)
38 sub ax,100
39 ; AX=AX-100, so AX (start_Y) now is in range -100..99
40 ; DX is in range 0..319 or 0x0000..0x013F
41 dec dh
42 ; DX now is in range 0xFF00..0x003F (-256..63)
43
44 xor bx,bx
45 xor si,si
46 ; BX (temp_X)=0; SI (temp_Y)=0
47
48 ; get maximal number of iterations
49 ; CX is still 320 here, so this is also maximal number of iteration
50 MandelLoop:
51 mov bp,si ; BP = temp_Y
52 imul si,bx ; SI = temp_X*temp_Y
53 add si,si ; SI = SI*2 = (temp_X*temp_Y)*2
54 imul bx,bx ; BX = BX^2 = temp_X^2
55 jo MandelBreak ; overflow?
56 imul bp,bp ; BP = BP^2 = temp_Y^2
57 jo MandelBreak ; overflow?
58 add bx,bp ; BX = BX+BP = temp_X^2 + temp_Y^2
59 jo MandelBreak ; overflow?
60 sub bx,bp ; BX = BX-BP = temp_X^2 + temp_Y^2 - temp_Y^2 = temp_X^2
61 sub bp,bp ; BP = BP-BP = temp_Y^2 - temp_Y^2
62
```

```

63 ; correct scale:
64 sar bx,6      ; BX=BX/64
65 add bx,dx     ; BX=BX+start_X
66 ; now temp_X = temp_X^2 - temp_Y^2 + start_X
67 sar si,6      ; SI=SI/64
68 add si,ax     ; SI=SI+start_Y
69 ; now temp_Y = (temp_X*temp_Y)*2 + start_Y
70
71 loop MandelLoop
72
73 MandelBreak:
74 ; CX=iterations
75 xchg ax,cx
76 ; AX=iterations. store AL to VGA buffer at ES:[DI]
77 stosb
78 ; stosb also increments DI, so DI now points to the next point in VGA buffer
79 ; jump always, so this is eternal loop here
80 jmp FillLoop

```

#### Algorithm:

- Switch to 320\*200 VGA video mode, 256 colors.  $320 * 200 = 64000$  (0xFA00).

Each pixel is encoded by one byte, so the buffer size is 0xFA00 bytes. It is addressed using the ES:DI registers pair.

ES must be 0xA000 here, because this is the segment address of the VGA video buffer, but storing 0xA000 to ES requires at least 4 bytes (PUSH 0A000h / POP ES). You can read more about the 16-bit MS-DOS memory model here: [11.6 on page 1000](#).

Assuming that BX is zero here, and the Program Segment Prefix is at the zeroth address, the 2-byte LES AX, [BX] instruction stores 0x20CD to AX and 0x9FFF to ES.

So the program starts to draw 16 pixels (or bytes) before the actual video buffer. But this is MS-DOS, there is no memory protection, so a write happens into the very end of conventional memory, and usually, there is nothing important. That's why you see a red strip 16 pixels wide at the right side. The whole picture is shifted left by 16 pixels. This is the price of saving 2 bytes.

- An infinite loop processes each pixel.

Probably, the most common way to enumerate all pixels on the screen is with two loops: one for the X coordinate, another for the Y coordinate. But then you'll need to multiply the coordinates to address a byte in the VGA video buffer.

The author of this demo decided to do it otherwise: enumerate all bytes in the video buffer by using one single loop instead of two, and get the coordinates of the current point using division. The resulting coordinates are: X in the range of  $-256..63$  and Y in the range of  $-100..99$ . You can see on the screenshot that the picture is somewhat shifted to the right part of screen.

That's because the biggest heart-shaped black hole usually appears on coordinates 0,0 and these are shifted here to right. Could the author just subtract 160 from the value to get X in the range of  $-160..159$ ? Yes, but the instruction SUB DX, 160 takes 4 bytes, while DEC DH—2 bytes (which subtracts 0x100 (256) from DX). So the whole picture is shifted for the cost of another 2 bytes of saved space.

- Check, if the current point is inside the Mandelbrot set. The algorithm is the one that has been described here.
- The loop is organized using the LOOP instruction, which uses the CX register as counter.

The author could set the number of iterations to some specific number, but he didn't: 320 is already present in CX (has been set at line 35), and this is good maximal iteration number anyway. We save here some space by not the reloading CX register with another value.

- IMUL is used here instead of MUL, because we work with signed values: keep in mind that the 0,0 coordinates has to be somewhere near the center of the screen.

It's the same with SAR (arithmetic shift for signed values): it's used instead of SHR.

- Another idea is to simplify the bounds check. We must check a coordinate pair, i.e., two variables. What the author does is to checks thrice for overflow: two squaring operations and one addition.

Indeed, we use 16-bit registers, which hold signed values in the range of -32768..32767, so if any of the coordinates is greater than 32767 during the signed multiplication, this point is definitely out of bounds: we jump to the MandelBreak label.

- There is also a division by 64 (SAR instruction). 64 sets scale.

Try to increase the value and you can get a closer look, or to decrease if for a more distant look.

- We are at the MandelBreak label, there are two ways of getting here: the loop ended with CX=0 (the point is inside the Mandelbrot set); or because an overflow has happened (CX still holds some value). Now we write the low 8-bit part of CX (CL) to the video buffer.

The default palette is rough, nevertheless, 0 is black: hence we see black holes in the places where the points are in the Mandelbrot set. The palette can be initialized at the program's start, but keep in mind, this is only a 64 bytes program!

- The program runs in an infinite loop, because an additional check where to stop, or any user interface will result in additional instructions.

Some other optimization tricks:

- The 1-byte CWD is used here for clearing DX instead of the 2-byte XOR DX, DX or even the 3-byte MOV DX, 0.
- The 1-byte XCHG AX, CX is used instead of the 2-byte MOV AX,CX. The current value of AX is not needed here anyway.
- DI (position in video buffer) is not initialized, and it is 0xFFFFE at the start <sup>51</sup>.

That's OK, because the program works for all DI in the range of 0..0xFFFF eternally, and the user can't notice that it is started off the screen (the last pixel of a 320\*200 video buffer is at address 0xF9FF). So some work is actually done off the limits of the screen.

Otherwise, you'll need an additional instructions to set DI to 0 and check for the video buffer's end.

## My "fixed" version

Listing 8.28: My "fixed" version

```
1  org 100h
2  mov al,13h
3  int 10h
4
5  ; set palette
6  mov dx, 3c8h
7  mov al, 0
8  out dx, al
9  mov cx, 100h
10 inc dx
11 l00:
12 mov al, cl
13 shl ax, 2
14 out dx, al ; red
15 out dx, al ; green
16 out dx, al ; blue
17 loop l00
18
19 push 0a000h
20 pop es
21
22 xor di, di
23
24 FillLoop:
25 cwd
26 mov ax,di
27 mov cx,320
28 div cx
29 sub ax,100
30 sub dx,160
31
32 xor bx,bx
```

<sup>51</sup>More information about initial register values: <http://go.yurichev.com/17004>

```

33 xor si,si
34
35 MandelLoop:
36 mov bp,si
37 imul si,bx
38 add si,si
39 imul bx,bx
40 jo MandelBreak
41 imul bp,bp
42 jo MandelBreak
43 add bx,bp
44 jo MandelBreak
45 sub bx,bp
46 sub bx,bp
47
48 sar bx,6
49 add bx,dx
50 sar si,6
51 add si,ax
52
53 loop MandelLoop
54
55 MandelBreak:
56 xchg ax,cx
57 stosb
58 cmp di, 0FA00h
59 jb FillLoop
60
61 ; wait for keypress
62 xor ax,ax
63 int 16h
64 ; set text video mode
65 mov ax, 3
66 int 10h
67 ; exit
68 int 20h

```

The author of these lines made an attempt to fix all these oddities: now the palette is smooth grayscale, the video buffer is at the correct place (lines 19..20), the picture is drawn on center of the screen (line 30), the program eventually ends and waits for the user's keypress (lines 58..68).

But now it's much bigger: 105 bytes (or 54 instructions) <sup>52</sup>.

<sup>52</sup>You can experiment by yourself: get DosBox and NASM and compile it as: `nasm file.asm -fbin -o file.com`

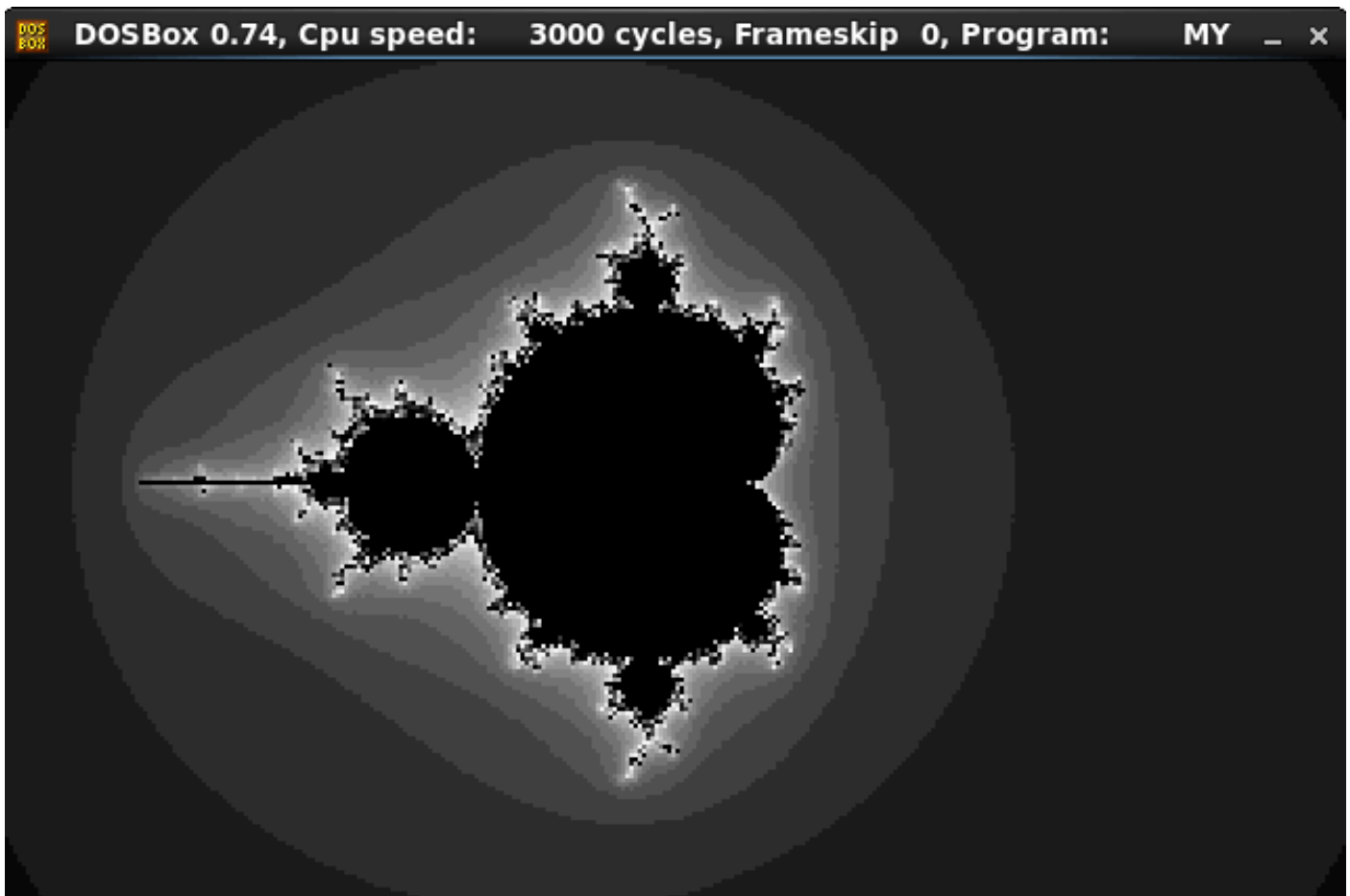

Figure 8.20: My “fixed” version

See also: small C program printing Mandelbrot set in ASCII: [https://people.sc.fsu.edu/~jburkardt/c\\_src/mandelbrot\\_ascii/mandelbrot\\_ascii.html](https://people.sc.fsu.edu/~jburkardt/c_src/mandelbrot_ascii/mandelbrot_ascii.html)  
<https://miyuki.github.io/2017/10/04/gcc-archaeology-1.html>.

## 8.16 A nasty bug in MSVCRT.DLL

This is the bug that costed me several hours of debugging.

In 2013 I was using MinGW, my C project seems to be very unstable and I saw the “Invalid parameter passed to C runtime function.” error message in debugger.

The error message was also visible using Sysinternals DebugView. And my project has no such error messages or strings. So I started to search it in the whole Windows and found in MSVCRT.DLL file. (Needless to say I was using Windows 7.)

So here it is, the error message in MSVCRT.DLL file supplied with Windows 7:

```
.text:6FFB69D0 OutputString      db 'Invalid parameter passed to C runtime function.',0Ah,0
.text:6FFB69D0                                     ; DATA XREF: sub_6FFB6930+83
```

Where it is referenced?

```
.text:6FFB6930 sub_6FFB6930      proc near                                     ; CODE XREF: _wfindfirst64+203FC
.text:6FFB6930                                                         ; sub_6FF62563+319AD
.text:6FFB6930
.text:6FFB6930 var_2D0          = dword ptr -2D0h
.text:6FFB6930 var_244          = word ptr -244h
.text:6FFB6930 var_240          = word ptr -240h
.text:6FFB6930 var_23C          = word ptr -23Ch
```

```

.text:6FFB6930 var_238      = word ptr -238h
.text:6FFB6930 var_234      = dword ptr -234h
.text:6FFB6930 var_230      = dword ptr -230h
.text:6FFB6930 var_22C      = dword ptr -22Ch
.text:6FFB6930 var_228      = dword ptr -228h
.text:6FFB6930 var_224      = dword ptr -224h
.text:6FFB6930 var_220      = dword ptr -220h
.text:6FFB6930 var_21C      = dword ptr -21Ch
.text:6FFB6930 var_218      = dword ptr -218h
.text:6FFB6930 var_214      = word ptr -214h
.text:6FFB6930 var_210      = dword ptr -210h
.text:6FFB6930 var_20C      = dword ptr -20Ch
.text:6FFB6930 var_208      = word ptr -208h
.text:6FFB6930 var_4        = dword ptr -4
.text:6FFB6930
.text:6FFB6930          mov     edi, edi
.text:6FFB6932          push   ebp
.text:6FFB6933          mov     ebp, esp
.text:6FFB6935          sub     esp, 2D0h
.text:6FFB693B          mov     eax, ___security_cookie
.text:6FFB6940          xor     eax, ebp
.text:6FFB6942          mov     [ebp+var_4], eax
.text:6FFB6945          mov     [ebp+var_220], eax
.text:6FFB694B          mov     [ebp+var_224], ecx
.text:6FFB6951          mov     [ebp+var_228], edx
.text:6FFB6957          mov     [ebp+var_22C], ebx
.text:6FFB695D          mov     [ebp+var_230], esi
.text:6FFB6963          mov     [ebp+var_234], edi
.text:6FFB6969          mov     [ebp+var_208], ss
.text:6FFB696F          mov     [ebp+var_214], cs
.text:6FFB6975          mov     [ebp+var_238], ds
.text:6FFB697B          mov     [ebp+var_23C], es
.text:6FFB6981          mov     [ebp+var_240], fs
.text:6FFB6987          mov     [ebp+var_244], gs
.text:6FFB698D          pushf
.text:6FFB698E          pop     [ebp+var_210]
.text:6FFB6994          mov     eax, [ebp+4]
.text:6FFB6997          mov     [ebp+var_218], eax
.text:6FFB699D          lea    eax, [ebp+4]
.text:6FFB69A0          mov     [ebp+var_2D0], 10001h
.text:6FFB69AA          mov     [ebp+var_20C], eax
.text:6FFB69B0          mov     eax, [eax-4]
.text:6FFB69B3          push   offset OutputString ; "Invalid parameter passed to C
runtime f"...
.text:6FFB69B8          mov     [ebp+var_21C], eax
.text:6FFB69BE          call   ds:OutputDebugStringA
.text:6FFB69C4          mov     ecx, [ebp+var_4]
.text:6FFB69C7          xor     ecx, ebp
.text:6FFB69C9          call   @__security_check_cookie@4 ; __security_check_cookie(x)
.text:6FFB69CE          leave
.text:6FFB69CF          retn
.text:6FFB69CF sub_6FFB6930  endp

```

The string it reported into debugger or DebugView utility using the standard `OutputDebugStringA()` function. How the `sub_6FFB6930` can be called? IDA shows at least 280 references.

Using my [tracer](#), I set a breakpoint at `sub_6FFB6930` to see, when it's called in my case:

```

tracer.exe -l:1.exe bpf=msvcrt.dll!0x6FFB6930 -s
...
PID=3560|New process 1.exe
(0) msvcrt.dll!0x6ffb6930() (called from msvcrt.dll!_ftol2_sse_excpt+0x1b467 (0x759ed222))
Call stack:
return address=0x401010 (1.exe!.text+0x10), arguments in stack: 0x12ff14, 0x401010, 0x403010("
↳ asd"), 0x0, 0x12ff88, 0x4010f8
return address=0x4010f8 (1.exe!0EP+0xe3), arguments in stack: 0x12ff88, 0x4010f8, 0x1, 0x2e0ea8
↳ , 0x2e1640, 0x403000

```

```

return address=0x75b6ef3c (KERNEL32.dll!BaseThreadInitThunk+0x12), arguments in stack: 0x12ff94
↳ , 0x75b6ef3c, 0x7ffdf000, 0x12ffd4, 0x77523688, 0x7ffdf000
return address=0x77523688 (ntdll.dll!RtlInitializeExceptionChain+0xef), arguments in stack: 0
↳ x12ffd4, 0x77523688, 0x7ffdf000, 0x74117ec7, 0x0, 0x0
return address=0x7752365b (ntdll.dll!RtlInitializeExceptionChain+0xc2), arguments in stack: 0
↳ x12ffec, 0x7752365b, 0x401015, 0x7ffdf000, 0x0, 0x0
(0) msvcrt.dll!0x6ffb6930() -> 0x12f94c
PID=3560|Process 1.exe exited. ExitCode=2147483647 (0x7fffffff)

```

I found that my code was calling stricmp() function with NULL as one argument. In fact, I made up this example when writing this:

```

#include <stdio.h>
#include <string.h>

int main()
{
    stricmp ("asd", NULL);
};

```

If this piece of code is compiled using old MinGW or old MSVC 6.0, it is linked against MSVCRT.DLL file. Which, as of Windows 7, silently sends the "Invalid parameter passed to C runtime function." error message to the debugger and then does nothing!

Let's see how stricmp() is implemented in MSVCRT.DLL:

```

.text:6FF5DB38 ; Exported entry 855. _strcmpi
.text:6FF5DB38 ; Exported entry 863. _stricmp
.text:6FF5DB38 ; ===== S U B R O U T I N E =====
.text:6FF5DB38 ; Attributes: bp-based frame
.text:6FF5DB38 ; int __cdecl strcmpi(const char *, const char *)
.text:6FF5DB38 public _strcmpi
.text:6FF5DB38 _strcmpi proc near ; CODE XREF: LocaleEnumProc-2B
.text:6FF5DB38 ; LocaleEnumProc+5E
.text:6FF5DB38 arg_0 = dword ptr 8
.text:6FF5DB38 arg_4 = dword ptr 0Ch
.text:6FF5DB38 ; FUNCTION CHUNK AT .text:6FF68CFD SIZE 00000012 BYTES
.text:6FF5DB38 ; FUNCTION CHUNK AT .text:6FF9D20D SIZE 00000022 BYTES
.text:6FF5DB38 mov edi, edi ; _strcmpi
.text:6FF5DB3A push ebp
.text:6FF5DB3B mov ebp, esp
.text:6FF5DB3D push esi
.text:6FF5DB3E xor esi, esi
.text:6FF5DB40 cmp dword_6FFF0000, esi
.text:6FF5DB46 jnz loc_6FF68CFD
.text:6FF5DB4C cmp [ebp+arg_0], esi ; is arg_0==NULL?
.text:6FF5DB4F jz loc_6FF9D20D
.text:6FF5DB55 cmp [ebp+arg_4], esi ; is arg_4==NULL?
.text:6FF5DB58 jz loc_6FF9D20D
.text:6FF5DB5E pop esi
.text:6FF5DB5F pop ebp
.text:6FF5DB5F _strcmpi endp ; sp-analysis failed

```

Actual strings comparison here:

```

.text:6FF5DB60 sub_6FF5DB60 proc near ; CODE XREF: _stricmp_l+16C7F
.text:6FF5DB60 ; sub_6FFD19CD+229
.text:6FF5DB60 arg_0 = dword ptr 8

```

```

.text:6FF5DB60 arg_4          = dword ptr 0Ch
.text:6FF5DB60
.text:6FF5DB60          push   ebp
.text:6FF5DB61          mov    ebp, esp
.text:6FF5DB63          push   edi
.text:6FF5DB64          push   esi
.text:6FF5DB65          push   ebx
.text:6FF5DB66          mov    esi, [ebp+arg_4]
.text:6FF5DB69          mov    edi, [ebp+arg_0]
.text:6FF5DB6C          mov    al, 0FFh
.text:6FF5DB6E          mov    edi, edi
.text:6FF5DB70
.text:6FF5DB70 loc_6FF5DB70:          ; CODE XREF: sub_6FF5DB60+20
.text:6FF5DB70          ; sub_6FF5DB60+40
.text:6FF5DB70          or     al, al
.text:6FF5DB72          jz     short loc_6FF5DBA6
.text:6FF5DB74          mov    al, [esi]
.text:6FF5DB76          add    esi, 1
.text:6FF5DB79          mov    ah, [edi]
.text:6FF5DB7B          add    edi, 1
.text:6FF5DB7E          cmp    ah, al
.text:6FF5DB80          jz     short loc_6FF5DB70
.text:6FF5DB82          sub    al, 41h
.text:6FF5DB84          cmp    al, 1Ah
.text:6FF5DB86          sbb   cl, cl
.text:6FF5DB88          and    cl, 20h
.text:6FF5DB8B          add    al, cl
.text:6FF5DB8D          add    al, 41h
.text:6FF5DB8F          xchg  ah, al
.text:6FF5DB91          sub    al, 41h
.text:6FF5DB93          cmp    al, 1Ah
.text:6FF5DB95          sbb   cl, cl
.text:6FF5DB97          and    cl, 20h
.text:6FF5DB9A          add    al, cl
.text:6FF5DB9C          add    al, 41h
.text:6FF5DB9E          cmp    al, ah
.text:6FF5DBA0          jz     short loc_6FF5DB70
.text:6FF5DBA2          sbb   al, al
.text:6FF5DBA4          sbb   al, 0FFh
.text:6FF5DBA6
.text:6FF5DBA6 loc_6FF5DBA6:          ; CODE XREF: sub_6FF5DB60+12
.text:6FF5DBA6          movsx  eax, al
.text:6FF5DBA9          pop    ebx
.text:6FF5DBAA          pop    esi
.text:6FF5DBAB          pop    edi
.text:6FF5DBAC          leave
.text:6FF5DBAD          retn
.text:6FF5DBAD sub_6FF5DB60          endp

.text:6FF68D0C loc_6FF68D0C:          ; CODE XREF: _strcmipi+3F6F2
.text:6FF68D0C          pop    esi
.text:6FF68D0D          pop    ebp
.text:6FF68D0E          retn

.text:6FF9D20D loc_6FF9D20D:          ; CODE XREF: _strcmipi+17
.text:6FF9D20D          ; _strcmipi+20
.text:6FF9D20D          call   near ptr _errno
.text:6FF9D212          push   esi
.text:6FF9D213          push   esi
.text:6FF9D214          push   esi
.text:6FF9D215          push   esi
.text:6FF9D216          push   esi
.text:6FF9D217          mov    dword ptr [eax], 16h
.text:6FF9D21D          call   _invalid_parameter
.text:6FF9D222          add    esp, 14h
.text:6FF9D225          mov    eax, 7FFFFFFFh
.text:6FF9D22A          jmp    loc_6FF68D0C

```

Now the `invalid_parameter()` function:



```
.text:6FFB6A06          public _invalid_parameter
.text:6FFB6A06 _invalid_parameter proc near          ; CODE XREF: sub_6FF5B494:loc_6FF5B618
.text:6FFB6A06                                         ; sub_6FF5CCFD:loc_6FF5C8A2
.text:6FFB6A06          mov     edi, edi
.text:6FFB6A08          push   ebp
.text:6FFB6A09          mov     ebp, esp
.text:6FFB6A0B          pop    ebp
.text:6FFB6A0C          jmp    sub_6FFB6930
.text:6FFB6A0C _invalid_parameter endp
```

The `invalid_parameter()` function eventually calls the function with `OutputDebugStringA()`: [8.16 on page 915](#).

You see, the `stricmp()` code is like:

```
int stricmp(const char *s1, const char *s2, size_t len)
{
    if (s1==NULL || s2==NULL)
    {
        // print error message AND exit:
        return 0x7FFFFFFFh;
    };
    // do comparison
};
```

How come this error is rare? Because newer MSVC versions links against `MSVCR120.DLL` file, etc (where 120 is version number).

Let's peek inside the newer `MSVCR120.DLL` from Windows 7:

```
.text:1002A0D4          public _stricmp_l
.text:1002A0D4 _stricmp_l          proc near          ; CODE XREF: _stricmp+18
.text:1002A0D4                                         ; _mbsicmp_l+47
.text:1002A0D4                                         ; DATA XREF: ...
.text:1002A0D4          var_10      = dword ptr -10h
.text:1002A0D4          var_8       = dword ptr -8
.text:1002A0D4          var_4       = byte ptr -4
.text:1002A0D4          arg_0       = dword ptr 8
.text:1002A0D4          arg_4       = dword ptr 0Ch
.text:1002A0D4          arg_8       = dword ptr 10h
.text:1002A0D4          ; FUNCTION CHUNK AT .text:1005AA7B SIZE 0000002A BYTES
.text:1002A0D4          push      ebp
.text:1002A0D5          mov     ebp, esp
.text:1002A0D7          sub     esp, 10h
.text:1002A0DA          lea    ecx, [ebp+var_10]
.text:1002A0DD          push    ebx
.text:1002A0DE          push    esi
.text:1002A0DF          push    edi
.text:1002A0E0          push    [ebp+arg_8]
.text:1002A0E3          call   sub_1000F764
.text:1002A0E8          mov     edi, [ebp+arg_0] ; arg==NULL?
.text:1002A0EB          test   edi, edi
.text:1002A0ED          jz     loc_1005AA7B
.text:1002A0F3          mov     ebx, [ebp+arg_4] ; arg==NULL?
.text:1002A0F6          test   ebx, ebx
.text:1002A0F8          jz     loc_1005AA7B
.text:1002A0FE          mov     eax, [ebp+var_10]
.text:1002A101          cmp    dword ptr [eax+0A8h], 0
.text:1002A108          jz     loc_1005AA95
.text:1002A10E          sub    edi, ebx
...

```

```

.text:1005AA7B loc_1005AA7B:                                ; CODE XREF: _stricmp_l+19
.text:1005AA7B                                           ; _stricmp_l+24
.text:1005AA7B      call    _errno
.text:1005AA80      mov     dword ptr [eax], 16h
.text:1005AA86      call   _invalid_parameter_noinfo
.text:1005AA8B      mov     esi, 7FFFFFFFh
.text:1005AA90      jmp    loc_1002A13B

...

.text:100A4670 _invalid_parameter_noinfo proc near          ; CODE XREF: sub_10013BEC-10F
.text:100A4670                                           ; sub_10016C0F-10F
.text:100A4670      xor     eax, eax
.text:100A4672      push   eax
.text:100A4673      push   eax
.text:100A4674      push   eax
.text:100A4675      push   eax
.text:100A4676      push   eax
.text:100A4677      call   _invalid_parameter
.text:100A467C      add     esp, 14h
.text:100A467F      retn
.text:100A467F _invalid_parameter_noinfo endp

...

.text:100A4645 _invalid_parameter proc near              ; CODE XREF: _invalid_parameter(ushort
      const *,ushort const *,ushort const *,uint,uint)
.text:100A4645                                           ; _invalid_parameter_noinfo+7
.text:100A4645      arg_0      = dword ptr 8
.text:100A4645      arg_4      = dword ptr 0Ch
.text:100A4645      arg_8      = dword ptr 10h
.text:100A4645      arg_C      = dword ptr 14h
.text:100A4645      arg_10     = dword ptr 18h
.text:100A4645      push    ebp
.text:100A4646      mov     ebp, esp
.text:100A4648      push   dword_100E0ED8 ; Ptr
.text:100A464E      call   ds:DecodePointer
.text:100A4654      test   eax, eax
.text:100A4656      jz     short loc_100A465B
.text:100A4658      pop    ebp
.text:100A4659      jmp    eax
.text:100A465B ; -----
.text:100A465B
.text:100A465B loc_100A465B:                                ; CODE XREF: _invalid_parameter+11
.text:100A465B      push   [ebp+arg_10]
.text:100A465E      push   [ebp+arg_C]
.text:100A4661      push   [ebp+arg_8]
.text:100A4664      push   [ebp+arg_4]
.text:100A4667      push   [ebp+arg_0]
.text:100A466A      call   _invoke_watson
.text:100A466F      int    3 ; Trap to Debugger
.text:100A466F _invalid_parameter endp

.text:100A469B _invoke_watson proc near                    ; CODE XREF: sub_1002CDB0+27068
.text:100A469B                                           ; sub_10029704+2A792
.text:100A469B      push   17h ; ProcessorFeature
.text:100A469D      call   IsProcessorFeaturePresent
.text:100A46A2      test   eax, eax
.text:100A46A4      jz     short loc_100A46AB
.text:100A46A6      push   5
.text:100A46A8      pop    ecx
.text:100A46A9      int    29h ; Win8: RtlFailFast(ecx)
.text:100A46AB ; -----
.text:100A46AB
.text:100A46AB loc_100A46AB:                                ; CODE XREF: _invoke_watson+9
.text:100A46AB      push   esi
.text:100A46AC      push   1
.text:100A46AE      mov    esi, 0C0000417h

```

```

.text:100A46B3      push     esi
.text:100A46B4      push     2
.text:100A46B6      call    sub_100A4519
.text:100A46BB      push     esi                ; uExitCode
.text:100A46BC      call    __crtTerminateProcess
.text:100A46C1      add     esp, 10h
.text:100A46C4      pop     esi
.text:100A46C5      retn
.text:100A46C5      _invoke_watson  endp

```

Now the `invalid_parameter()` function is rewritten in newer MSVCR\*.DLL version, it shows the message box, if you want to kill the process or call debugger. Of course, this is much better than silently return. Perhaps, Microsoft forgot to fix MSVCRT.DLL since then.

But how it was working in the era of Windows XP? It wasn't: MSVCRT.DLL from Windows XP doesn't check arguments against NULL. So under Windows XP my `stricmp("asd", NULL)` code will crash, and this is good.

My hypothesis: Microsoft upgraded MSVCR\*.DLL files (including MSVCRT.DLL) for Windows 7 by adding sanitizing checks everywhere. However, since MSVCRT.DLL wasn't used much since MSVS .NET (year 2002), it wasn't properly tested and the bug left here. But compilers like MinGW can still use this DLL.

What would I do without my reverse engineering skills?

The MSVCRT.DLL from Windows 8.1 has the same bug.

## 8.17 Other examples

An example about Z3 and manual decompilation was here. It is moved there: [https://yurichev.com/writings/SAT\\_SMT\\_by\\_example.pdf](https://yurichev.com/writings/SAT_SMT_by_example.pdf).

# Chapter 9

## Examples of reversing proprietary file formats

### 9.1 Primitive XOR-encryption

#### 9.1.1 Simplest ever XOR encryption

I once saw a software where all debugging messages has been encrypted using XOR by value of 3. In other words, two lowest bits of all characters has been flipped.

“Hello, world” would become “Kfool/#tlqog”:

```
#!/usr/bin/python
msg="Hello, world!"
print "".join(map(lambda x: chr(ord(x)^3), msg))
```

This is quite interesting encryption (or rather obfuscation), because it has two important properties: 1) single function for encryption/decryption, just apply it again; 2) resulting characters are also printable, so the whole string can be used in source code without escaping characters.

The second property exploits the fact that all printable characters organized in rows: 0x2x-0x7x, and when you flip two lowest bits, character *moving* 1 or 3 characters left or right, but never *moved* to another (maybe non-printable) row:

	0	1	2	3	4	5	6	7	8	9	A	B	C	D	E	F
0x	C-@	C-a	C-b	C-c	C-d	C-e	C-f	C-g	C-h	TAB	C-j	C-k	C-l	RET	C-n	C-o
1x	C-p	C-q	C-r	C-s	C-t	C-u	C-v	C-w	C-x	C-y	C-z	ESC	C-\	C-]	C-^	C-_
2x		!	"	#	\$	%	&	'	(	)	*	+	,	-	.	/
3x	0	1	2	3	4	5	6	7	8	9	:	;	<	=	>	?
4x	@	A	B	C	D	E	F	G	H	I	J	K	L	M	N	O
5x	P	Q	R	S	T	U	V	W	X	Y	Z	[	\	]	^	_
6x	`	a	b	c	d	e	f	g	h	i	j	k	l	m	n	o
7x	p	q	r	s	t	u	v	w	x	y	z	{		}	~	DEL

Figure 9.1: 7-bit ASCII table in Emacs

...with a single exception of 0x7F character.

For example, let's *encrypt* characters in A-Z range:

```
#!/usr/bin/python
msg="@ABCDEFGHijklmno"
```

```
print "".join(map(lambda x: chr(ord(x)^3), msg))
```

Result:

```
CBA@GFEDKJIHONML
```

It's like "@" and "C" characters has been swapped, and so are "B" and "a".

Yet again, this is interesting example of exploiting XOR properties, rather than encryption: the very same effect of *preserving printableness* can be achieved while flipping any of lowest 4 bits, in any combination.

### 9.1.2 Norton Guide: simplest possible 1-byte XOR encryption

Norton Guide was popular in the epoch of MS-DOS, it was a resident program that worked as a hypertext reference manual.

Norton Guide’s databases are files with the extension .ng, the contents of which look encrypted:

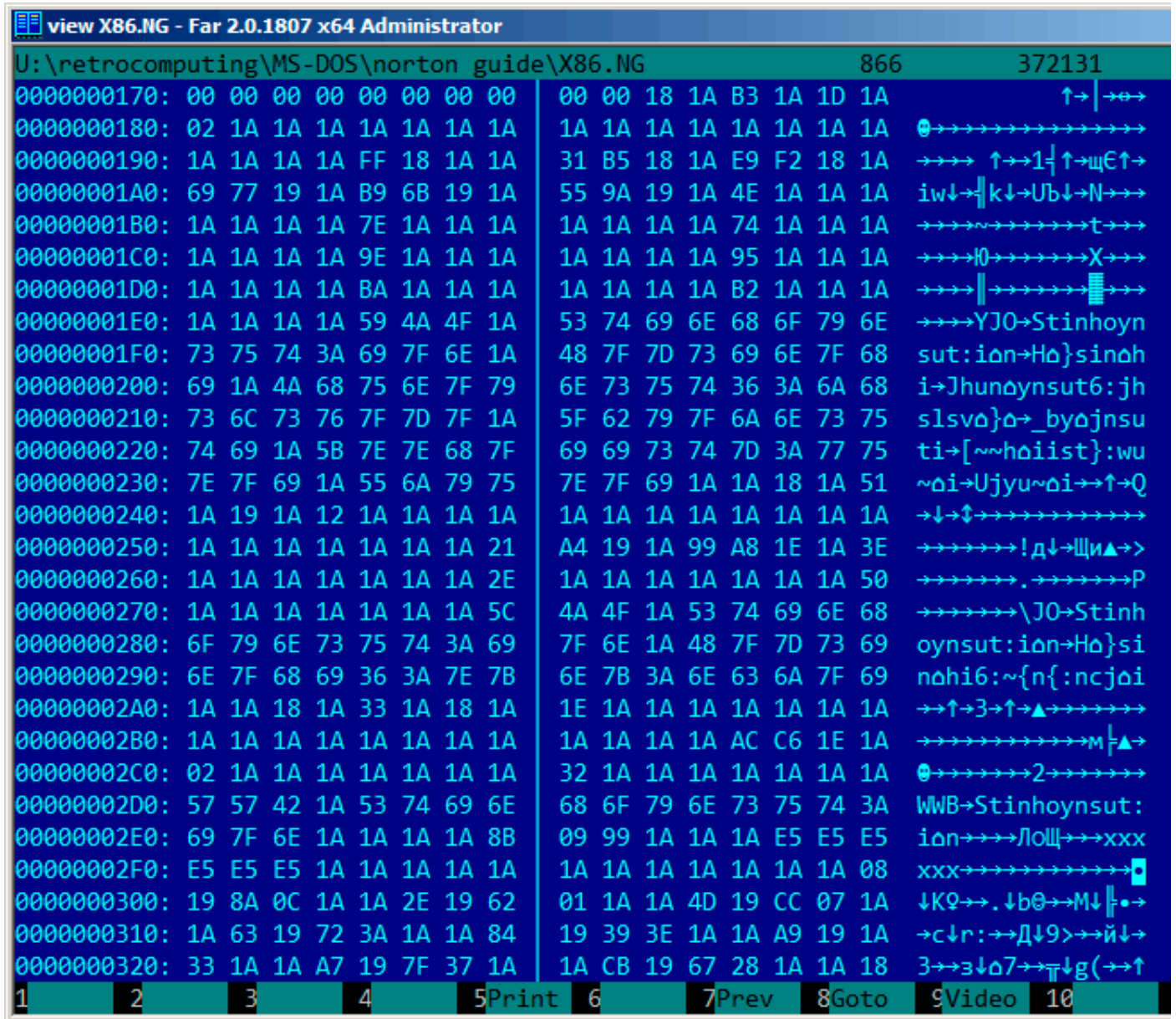

Figure 9.2: Very typical look

Why did we think that it’s encrypted but not compressed?

We see that the 0x1A byte (looking like “→”) occurs often, it would not be possible in a compressed file.

We also see long parts that consist only of Latin letters, and they look like strings in an unknown language.

Since the 0x1A byte occurs so often, we can try to decrypt the file, assuming that it's encrypted by the simplest XOR-encryption.

If we apply XOR with the 0x1A constant to each byte in Hiew, we can see familiar English text strings:

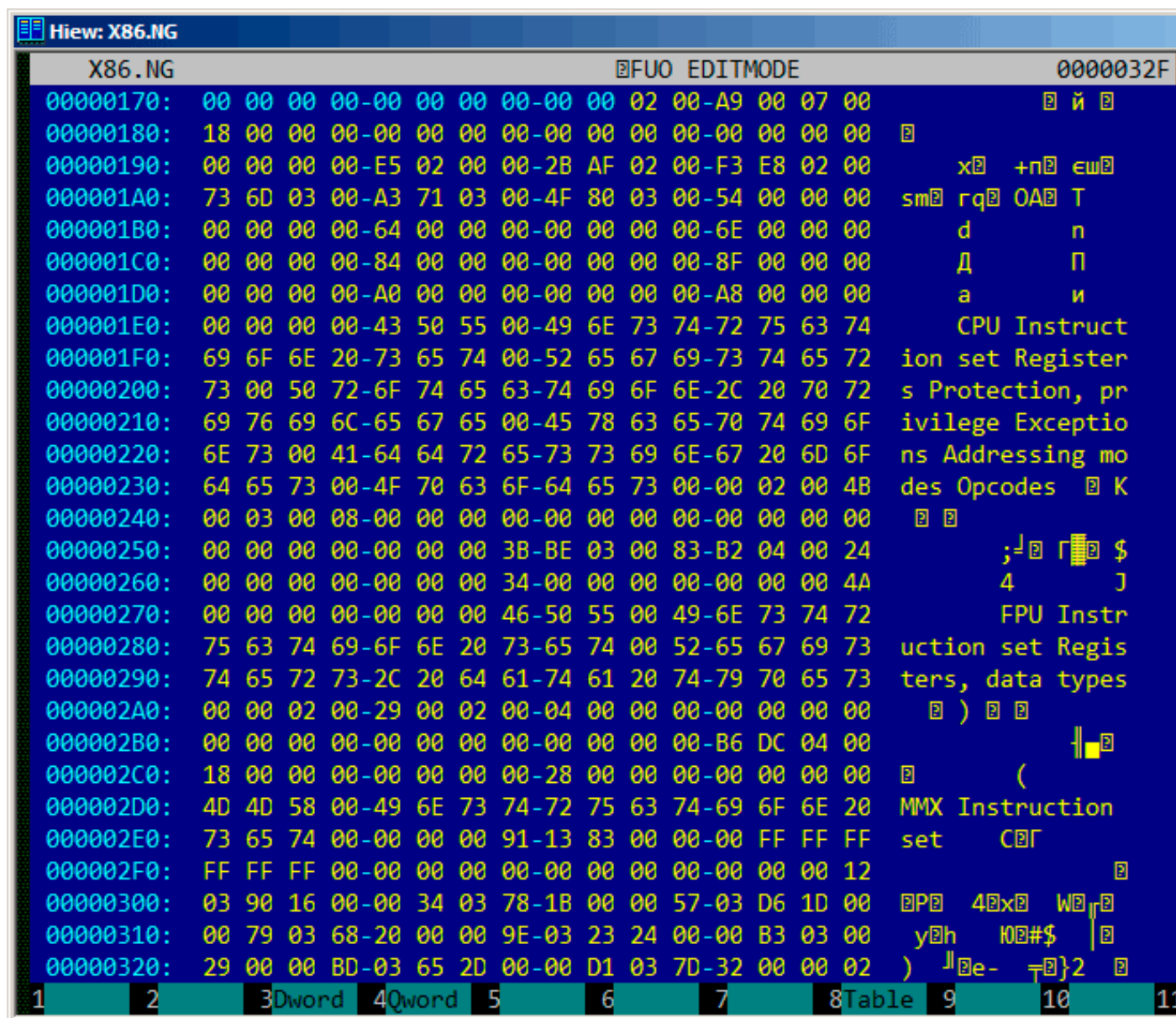

Figure 9.3: Hiew XORing with 0x1A

XOR encryption with one single constant byte is the simplest possible encryption method, which is, nevertheless, encountered sometimes.

Now we understand why the 0x1A byte is occurring so often: because there are so many zero bytes and they were replaced by 0x1A in encrypted form.

But the constant might be different. In this case, we could try every constant in the 0..255 range and look for something familiar in the decrypted file. 256 is not so much.

More about Norton Guide's file format: <http://go.yurichev.com/17317>.

## Entropy

A very important property of such primitive encryption systems is that the information entropy of the encrypted/decrypted block is the same.

Here is my analysis in Wolfram Mathematica 10.

### Listing 9.1: Wolfram Mathematica 10

```
In[1]:= input = BinaryReadList["X86.NG"];  
  
In[2]:= Entropy[2, input] // N  
Out[2]= 5.62724  
  
In[3]:= decrypted = Map[BitXor[#, 16^1A] &, input];  
  
In[4]:= Export["X86_decrypted.NG", decrypted, "Binary"];  
  
In[5]:= Entropy[2, decrypted] // N  
Out[5]= 5.62724  
  
In[6]:= Entropy[2, ExampleData[{"Text", "ShakespearesSonnets"}]] // N  
Out[6]= 4.42366
```

What we do here is load the file, get its entropy, decrypt it, save it and get the entropy again (the same!). Mathematica also offers some well-known English language texts for analysis.

So we also get the entropy of Shakespeare's sonnets, and it is close to the entropy of the file we just analyzed.

The file we analyzed consists of English language sentences, which are close to the language of Shakespeare.

And the XOR-ed bitwise English language text has the same entropy.

However, this is not true when the file is XOR-ed with a pattern larger than one byte.

The file we analyzed can be downloaded here: [http://beginners.re/examples/norton\\_guide/X86.NG](http://beginners.re/examples/norton_guide/X86.NG).

#### **One more word about base of entropy**

Wolfram Mathematica calculates entropy with base of  $e$  (base of the natural logarithm), and the UNIX *ent* utility<sup>1</sup> uses base 2.

So we set base 2 explicitly in Entropy command, so Mathematica will give us the same results as the *ent* utility.

---

<sup>1</sup><http://www.fourmilab.ch/random/>



### 9.1.3 Simplest possible 4-byte XOR encryption

If a longer pattern was used for XOR-encryption, for example a 4 byte pattern, it's easy to spot as well. For example, here is the beginning of the kernel32.dll file (32-bit version from Windows Server 2008):

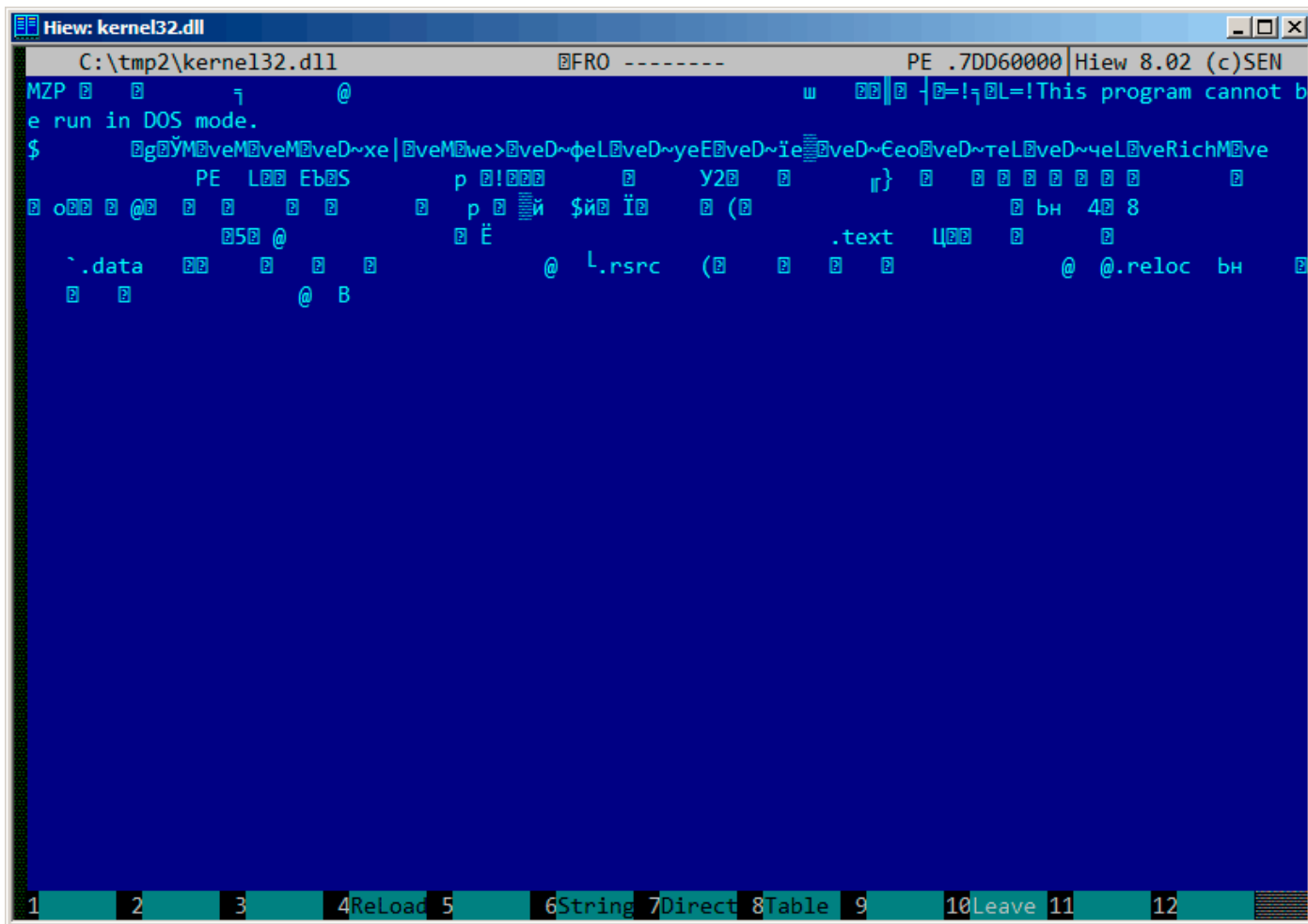

Figure 9.4: Original file

Here it is “encrypted” with a 4-byte key:

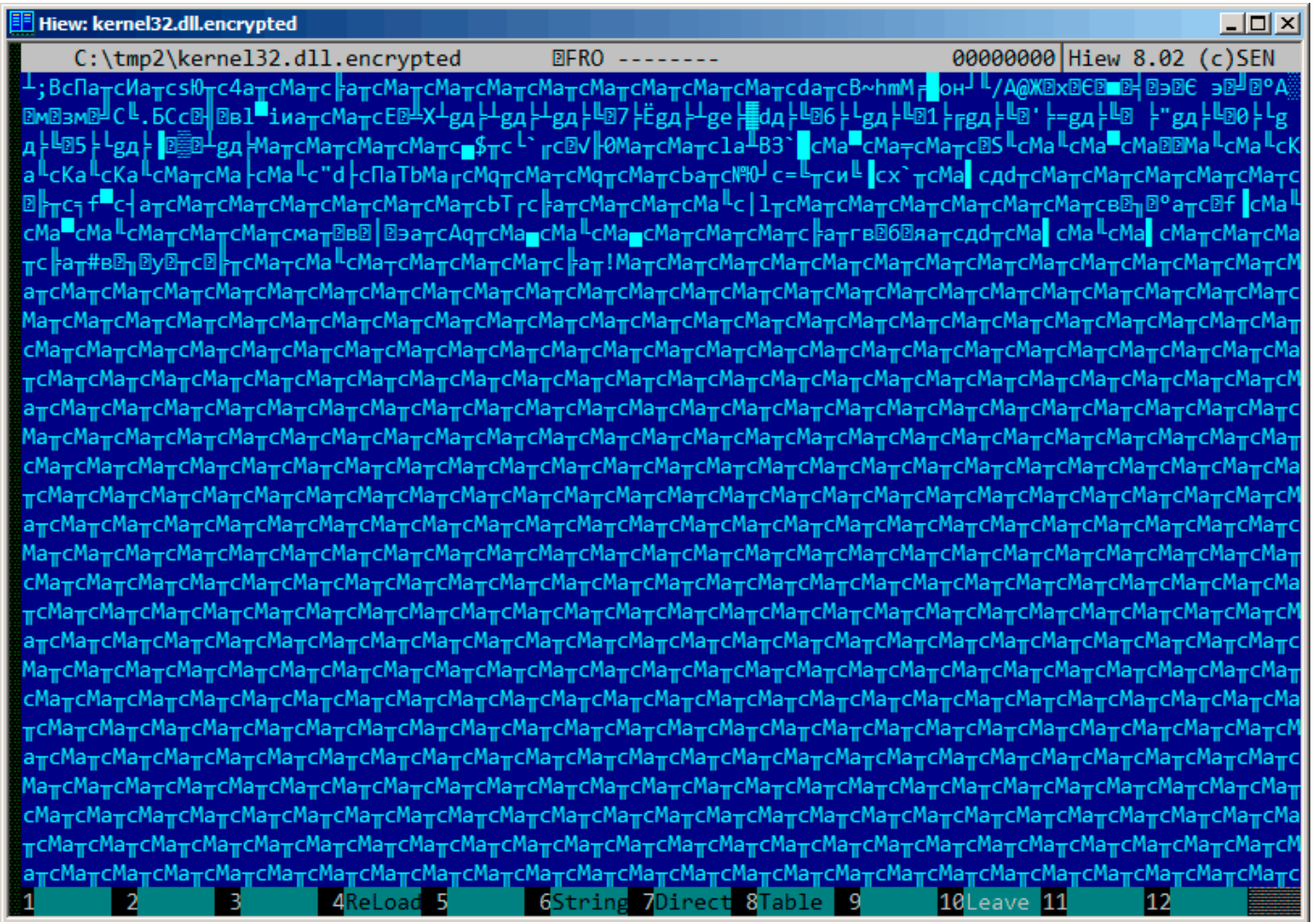

Figure 9.5: “Encrypted” file

It’s very easy to spot the recurring 4 symbols.

Indeed, the header of a PE-file has a lot of long zero areas, which are the reason for the key to become visible.

Here is the beginning of a PE-header in hexadecimal form:

```

Hiew: kernel32.dll
C:\tmp2\kernel32.dll  FRO ----- PE .7DD60290
.7DD600E0: 00 00 00 00-00 00 00 00-50 45 00 00-4C 01 04 00 PE L
.7DD600F0: 85 9A 15 53-00 00 00 00-00 00 00 00-E0 00 02 21 EбS р!
.7DD60100: 0B 01 09 00-00 00 0D 00-00 00 03 00-00 00 00 00
.7DD60110: 93 32 01 00-00 00 01 00-00 00 0D 00-00 00 D6 7D Y2 }
.7DD60120: 00 00 01 00-00 00 01 00-06 00 01 00-06 00 01 00
.7DD60130: 06 00 01 00-00 00 00 00-00 00 11 00-00 00 01 00
.7DD60140: AE 05 11 00-03 00 40 01-00 00 04 00-00 10 00 00 о @
.7DD60150: 00 00 10 00-00 10 00 00-00 00 00 00-10 00 00 00
.7DD60160: 70 FF 0B 00-B1 A9 00 00-24 A9 0C 00-F4 01 00 00 р й $й İ
.7DD60170: 00 00 0F 00-28 05 00 00-00 00 00 00-00 00 00 00
.7DD60180: 00 00 00 00-00 00 00 00-00 00 10 00-9C AD 00 00 б БН
.7DD60190: 34 07 0D 00-38 00 00 00-00 00 00 00-00 00 00 00 4 8
.7DD601A0: 00 00 00 00-00 00 00 00-00 00 00 00-00 00 00 00
.7DD601B0: 10 35 08 00-40 00 00 00-00 00 00 00-00 00 00 00 5 @
.7DD601C0: 00 00 01 00-F0 0D 00 00-00 00 00 00-00 00 00 00
.7DD601D0: 00 00 00 00-00 00 00 00-00 00 00 00-00 00 00 00
.7DD601E0: 2E 74 65 78-74 00 00 00-96 07 0C 00-00 00 01 00 .text Ц
.7DD601F0: 00 00 0D 00-00 00 01 00-00 00 00 00-00 00 00 00
.7DD60200: 00 00 00 00-20 00 00 60-2E 64 61 74-61 00 00 00 ~.data
.7DD60210: 0C 10 00 00-00 00 0E 00-00 00 01 00-00 00 0E 00
.7DD60220: 00 00 00 00-00 00 00 00-00 00 00 00-40 00 00 C0 @ L
.7DD60230: 2E 72 73 72-63 00 00 00-28 05 00 00-00 00 0F 00 .rsrc (
.7DD60240: 00 00 01 00-00 00 0F 00-00 00 00 00-00 00 00 00
.7DD60250: 00 00 00 00-40 00 00 40-2E 72 65 6C-6F 63 00 00 @ @.reloc
.7DD60260: 9C AD 00 00-00 00 10 00-00 00 01 00-00 00 10 00 БН
.7DD60270: 00 00 00 00-00 00 00 00-00 00 00 00-40 00 00 42 @ B
.7DD60280: 00 00 00 00-00 00 00 00-00 00 00 00-00 00 00 00
.7DD60290: 00 00 00 00-00 00 00 00-00 00 00 00-00 00 00 00
1Global 2FilBlk 3CryBlk 4ReLoad 5 6String 7Direct 8Table 9 10Leave 11

```

Figure 9.6: PE-header

Here it is “encrypted”:

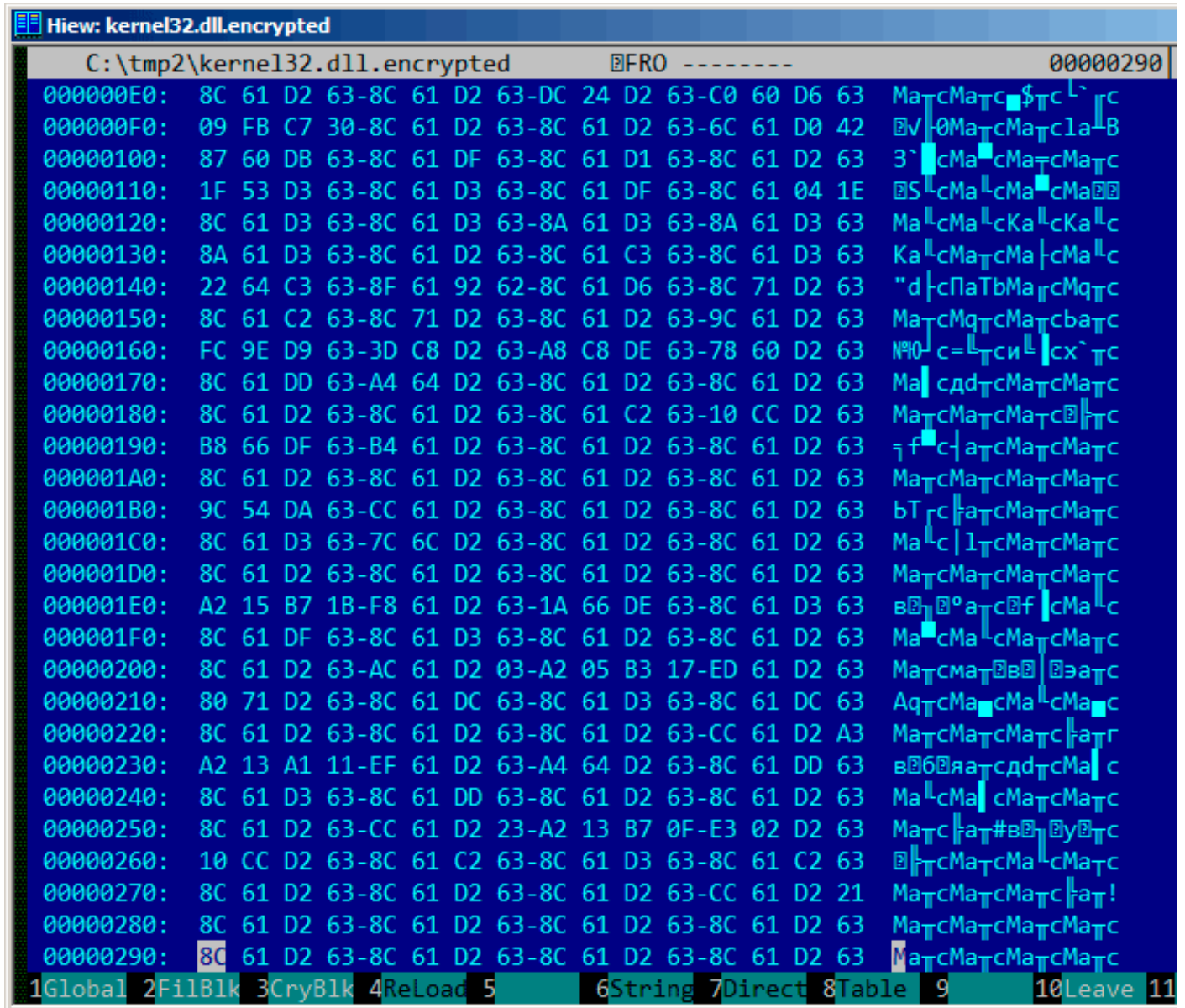

Figure 9.7: “Encrypted” PE-header

It’s easy to spot that the key is the following 4 bytes: 8C 61 D2 63.

With this information, it’s easy to decrypt the whole file.

So it is important to keep in mind these properties of PE-files: 1) PE-header has many zero-filled areas; 2) all PE-sections are padded with zeros at a page boundary (4096 bytes), so long zero areas are usually present after each section.

Some other file formats may contain long zero areas.

It’s typical for files used by scientific and engineering software.

For those who want to inspect these files on their own, they are downloadable here: <http://go.yurichev.com/17352>.

### Exercise

- <http://challenges.re/50>

## 9.1.4 Simple encryption using XOR mask

I've found an old interactive fiction game while diving deep into *if-archive*<sup>2</sup>:

```
The New Castle v3.5 - Text/Adventure Game
in the style of the original Infocom (tm)
type games, Zork, Colossal Cave (Adventure),
etc. Can you solve the mystery of the
abandoned castle?
Shareware from Software Customization.
Software Customization [ASP] Version 3.5 Feb. 2000
```

It's downloadable here: [https://beginners.re/current-tree/ff/XOR/mask\\_1/files/newcastle.tgz](https://beginners.re/current-tree/ff/XOR/mask_1/files/newcastle.tgz).

There is a file inside (named *castle.dbf*) which is clearly encrypted, but not by a real crypto algorithm, nor it's compressed, this is something rather simpler. I wouldn't even measure entropy level ( 9.2 on page 944) of the file, because I'm sure it's low. Here is how it looks like in Midnight Commander:

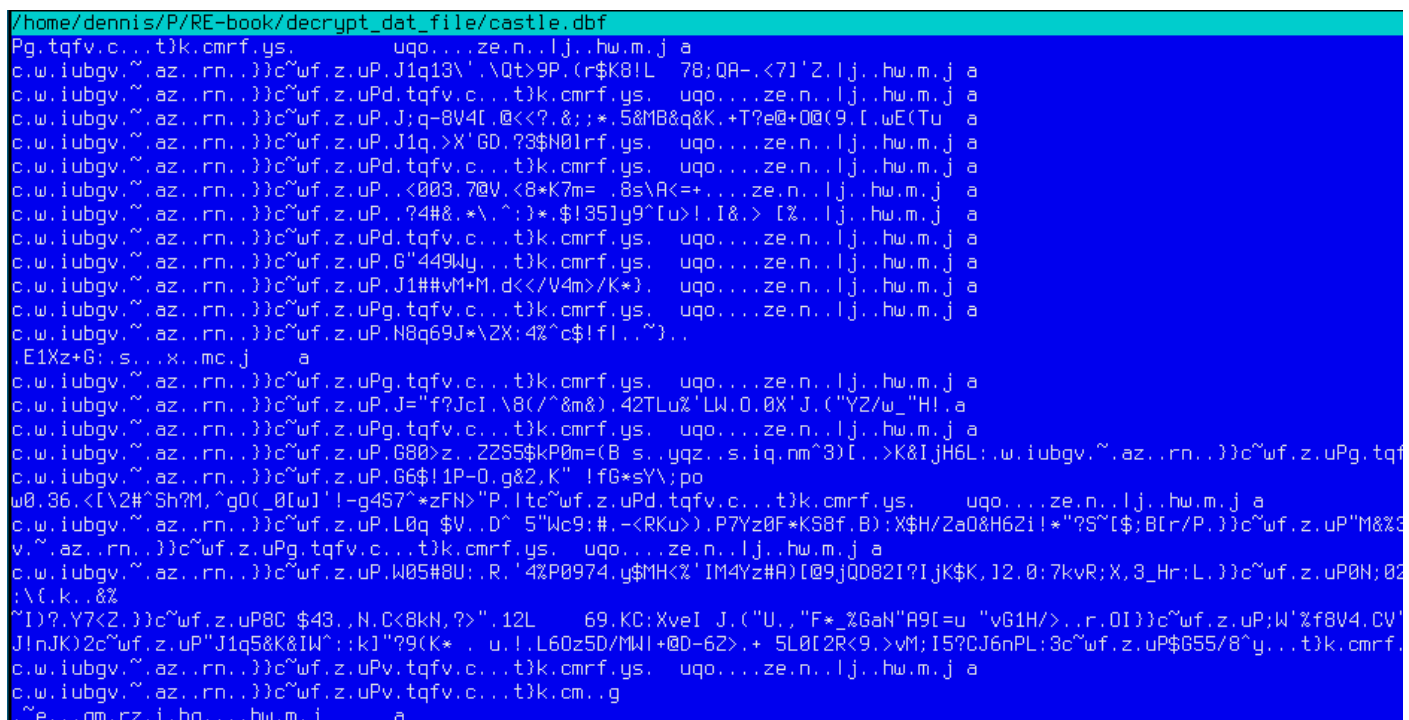

```
/home/dennis/P/RE-book/decrypt_dat_file/castle.dbf
Pg.tqfv.c...t)k.cmrf.ys.      uqo...ze.n..lj..hw.m.j a
c.w.iubgv.~.az..rn..})c~wf.z.uP.J1q13\'.\Qt>9P.(r$K8!L.78;QA-<7]'Z.|j..hw.m.j a
c.w.iubgv.~.az..rn..})c~wf.z.uPd.tqfv.c...t)k.cmrf.ys.      uqo...ze.n..lj..hw.m.j a
c.w.iubgv.~.az..rn..})c~wf.z.uP.J;q-8V4[.@<<?.&;*58MB&q&K.+T?e@+0@9[.wE(Tu a
c.w.iubgv.~.az..rn..})c~wf.z.uP.J1q.>X'GD.?3$N01rf.ys.      uqo...ze.n..lj..hw.m.j a
c.w.iubgv.~.az..rn..})c~wf.z.uPd.tqfv.c...t)k.cmrf.ys.      uqo...ze.n..lj..hw.m.j a
c.w.iubgv.~.az..rn..})c~wf.z.uP.<003.7@V.<@*K7m=.8s\A<+...ze.n..lj..hw.m.j a
c.w.iubgv.~.az..rn..})c~wf.z.uP.?.?4#&.*\.^:)*.$!35]y9^[u>!l&.> [%..lj..hw.m.j a
c.w.iubgv.~.az..rn..})c~wf.z.uPd.tqfv.c...t)k.cmrf.ys.      uqo...ze.n..lj..hw.m.j a
c.w.iubgv.~.az..rn..})c~wf.z.uP.G"449Wj...t)k.cmrf.ys.      uqo...ze.n..lj..hw.m.j a
c.w.iubgv.~.az..rn..})c~wf.z.uP.J1##vM+M.d<</V4m>/K*).      uqo...ze.n..lj..hw.m.j a
c.w.iubgv.~.az..rn..})c~wf.z.uPg.tqfv.c...t)k.cmrf.ys.      uqo...ze.n..lj..hw.m.j a
c.w.iubgv.~.az..rn..})c~wf.z.uP.N8q69J*\ZX:4%~c$!f!..~)..
.E1Xz+G;.s...x.mc.j a
c.w.iubgv.~.az..rn..})c~wf.z.uPg.tqfv.c...t)k.cmrf.ys.      uqo...ze.n..lj..hw.m.j a
c.w.iubgv.~.az..rn..})c~wf.z.uP.J="f?JcI.\8(/^&m&).42TLu%~LW.O.0X'J.("Y2/w_"H! a
c.w.iubgv.~.az..rn..})c~wf.z.uPg.tqfv.c...t)k.cmrf.ys.      uqo...ze.n..lj..hw.m.j a
c.w.iubgv.~.az..rn..})c~wf.z.uP.G80>z..2255$Kp0m=(B s..yqz;.s.iq.nm^3)[...K&IjH6L;.w.iubgv.~.az..rn..})c~wf.z.uPg.tqfv.c...t)k.cmrf.ys.      uqo...ze.n..lj..hw.m.j a
c.w.iubgv.~.az..rn..})c~wf.z.uP.G6$!1P-0.g&2,K" !fG*sY\;po
w0.36.<[ \2#^Sh?M.^g0[_0[w]'!-g457^*zFN>"P.ltc~wf.z.uPd.tqfv.c...t)k.cmrf.ys.      uqo...ze.n..lj..hw.m.j a
c.w.iubgv.~.az..rn..})c~wf.z.uP.L0q $V..D^ 5"Wc9:##.-<RKu>).P7Yz0F*K88f.B):X$H/Za0&H62i!*"?S"[$;B(r/P.))c~wf.z.uP"M&%3
v.~.az..rn..})c~wf.z.uPg.tqfv.c...t)k.cmrf.ys.      uqo...ze.n..lj..hw.m.j a
c.w.iubgv.~.az..rn..})c~wf.z.uP.W05#8U;.R. 4%P0974.y$MH<%~IM4Yz#A)[@9jQ082I?iJK$K.12.0:7kvr;X.3_Hr;L.))c~wf.z.uP0N;02
:\t.k..&%
~I)?..Y7<Z.))c~wf.z.uP8C $43..N.C<8kn.?)".12L      69.KC:XveI J.("U..F*_%GaN"A9[=u "v61H/>..r.OI))c~wf.z.uP;W'Zf8V4.CV'
J1nJK)2c~wf.z.uP"J1q5&K&IW^:;k]"9(K* .u.l.L60z5D/MWI+@0-6Z).+ 5L0[2R<9.>vM;I5?CJ6nPL:3c~wf.z.uP$655/8^y...t)k.cmrf.ys.
c.w.iubgv.~.az..rn..})c~wf.z.uPv.tqfv.c...t)k.cmrf.ys.      uqo...ze.n..lj..hw.m.j a
c.w.iubgv.~.az..rn..})c~wf.z.uPv.tqfv.c...t)k.cmrf.ys.      uqo...ze.n..lj..hw.m.j a
~e...qm.rz.i.bg...hw.m.j a
```

Figure 9.8: Encrypted file in Midnight Commander

The encrypted file can be downloaded here: [https://beginners.re/current-tree/ff/XOR/mask\\_1/files/castle.dbf.bz2](https://beginners.re/current-tree/ff/XOR/mask_1/files/castle.dbf.bz2).

Will it be possible to decrypt it without accessing to the program, using just this file?

There is a clearly visible pattern of repeating string. If a simple encryption by XOR mask was applied, such repeating strings is a prominent signature, because, probably, there were a long lacunas<sup>3</sup> of zero bytes, which, in turn, are present in many executable files as well as in binary data files.

Here I'll dump the file's beginning using *xxd* UNIX utility:

```
...
0000030: 09 61 0d 63 0f 77 14 69 75 62 67 76 01 7e 1d 61 .a.c.w.iubgv.~.a
0000040: 7a 11 0f 72 6e 03 05 7d 7d 63 7e 77 66 1e 7a 02 z..rn..})c~wf.z.
0000050: 75 50 02 4a 31 71 31 33 5c 27 08 5c 51 74 3e 39 uP.J1q13\'.\Qt>9
0000060: 50 2e 28 72 24 4b 38 21 4c 09 37 38 3b 51 41 2d P.(r$K8!L.78;QA-
0000070: 1c 3c 37 5d 27 5a 1c 7c 6a 10 14 68 77 08 6d 1a .<7]'Z.|j..hw.m.
```

<sup>2</sup><http://www.ifarchive.org/>

<sup>3</sup>As in [https://en.wikipedia.org/wiki/Lacuna\\_\(manuscripts\)](https://en.wikipedia.org/wiki/Lacuna_(manuscripts))

```

0000080: 6a 09 61 0d 63 0f 77 14 69 75 62 67 76 01 7e 1d j.a.c.w.iubgv.~.
0000090: 61 7a 11 0f 72 6e 03 05 7d 7d 63 7e 77 66 1e 7a az..rn..}}c~wf.z
00000a0: 02 75 50 64 02 74 71 66 76 19 63 08 13 17 74 7d .uPd.tqfv.c...t}
00000b0: 6b 19 63 6d 72 66 0e 79 73 1f 09 75 71 6f 05 04 k.cmrfsys..uqo..
00000c0: 7f 1c 7a 65 08 6e 0e 12 7c 6a 10 14 68 77 08 6d ..ze.n..|j..hw.m

00000d0: 1a 6a 09 61 0d 63 0f 77 14 69 75 62 67 76 01 7e .j.a.c.w.iubgv.~
00000e0: 1d 61 7a 11 0f 72 6e 03 05 7d 7d 63 7e 77 66 1e .az..rn..}}c~wf.
00000f0: 7a 02 75 50 01 4a 3b 71 2d 38 56 34 5b 13 40 3c z.uP.J;q-8V4[.@<
0000100: 3c 3f 19 26 3b 3b 2a 0e 35 26 4d 42 26 71 26 4b <?.&;*.5&MB&q&K
0000110: 04 2b 54 3f 65 40 2b 4f 40 28 39 10 5b 2e 77 45 .+T?e@+0@(9.[.wE

0000120: 28 54 75 09 61 0d 63 0f 77 14 69 75 62 67 76 01 (Tu.a.c.w.iubgv.
0000130: 7e 1d 61 7a 11 0f 72 6e 03 05 7d 7d 63 7e 77 66 ~.az..rn..}}c~wf
0000140: 1e 7a 02 75 50 02 4a 31 71 15 3e 58 27 47 44 17 .z.uP.Jlq.>X'GD.
0000150: 3f 33 24 4e 30 6c 72 66 0e 79 73 1f 09 75 71 6f ?3$N0lrf.sys..uqo
0000160: 05 04 7f 1c 7a 65 08 6e 0e 12 7c 6a 10 14 68 77 ....ze.n..|j..hw

...

```

Let's stick at visible repeating iubgv string. By looking at this dump, we can clearly see that the period of the string occurrence is 0x51 or 81. Probably, 81 is size of block? The size of the file is 1658961, and it can be divided evenly by 81 (and there are 20481 blocks then).

Now I'll use Mathematica to analyze, are there repeating 81-byte blocks in the file? I'll split input file by 81-byte blocks and then I'll use *Tally*<sup>4</sup> function which just counts, how many times some item has been occurred in the input list. Tally's output is not sorted, so I also add *Sort* function to sort it by number of occurrences in descending order.

```

input = BinaryReadList["/home/dennis/.../castle.dbf"];
blocks = Partition[input, 81];
stat = Sort[Tally[blocks], #1[[2]] > #2[[2]] &]

```

And here is output:

```

{{{80, 103, 2, 116, 113, 102, 118, 25, 99, 8, 19, 23, 116, 125, 107,
  25, 99, 109, 114, 102, 14, 121, 115, 31, 9, 117, 113, 111, 5, 4,
  127, 28, 122, 101, 8, 110, 14, 18, 124, 106, 16, 20, 104, 119, 8,
  109, 26, 106, 9, 97, 13, 99, 15, 119, 20, 105, 117, 98, 103, 118,
  1, 126, 29, 97, 122, 17, 15, 114, 110, 3, 5, 125, 125, 99, 126,
  119, 102, 30, 122, 2, 117}}, 1739},
{{80, 100, 2, 116, 113, 102, 118, 25, 99, 8, 19, 23, 116,
  125, 107, 25, 99, 109, 114, 102, 14, 121, 115, 31, 9, 117, 113,
  111, 5, 4, 127, 28, 122, 101, 8, 110, 14, 18, 124, 106, 16, 20,
  104, 119, 8, 109, 26, 106, 9, 97, 13, 99, 15, 119, 20, 105, 117,
  98, 103, 118, 1, 126, 29, 97, 122, 17, 15, 114, 110, 3, 5, 125,
  125, 99, 126, 119, 102, 30, 122, 2, 117}}, 1422},
{{80, 101, 2, 116, 113, 102, 118, 25, 99, 8, 19, 23, 116,
  125, 107, 25, 99, 109, 114, 102, 14, 121, 115, 31, 9, 117, 113,
  111, 5, 4, 127, 28, 122, 101, 8, 110, 14, 18, 124, 106, 16, 20,
  104, 119, 8, 109, 26, 106, 9, 97, 13, 99, 15, 119, 20, 105, 117,
  98, 103, 118, 1, 126, 29, 97, 122, 17, 15, 114, 110, 3, 5, 125,
  125, 99, 126, 119, 102, 30, 122, 2, 117}}, 1012},
{{80, 120, 2, 116, 113, 102, 118, 25, 99, 8, 19, 23, 116,
  125, 107, 25, 99, 109, 114, 102, 14, 121, 115, 31, 9, 117, 113,
  111, 5, 4, 127, 28, 122, 101, 8, 110, 14, 18, 124, 106, 16, 20,
  104, 119, 8, 109, 26, 106, 9, 97, 13, 99, 15, 119, 20, 105, 117,
  98, 103, 118, 1, 126, 29, 97, 122, 17, 15, 114, 110, 3, 5, 125,
  125, 99, 126, 119, 102, 30, 122, 2, 117}}, 377},

...

{{80, 2, 74, 49, 113, 21, 62, 88, 39, 71, 68, 23, 63, 51, 36, 78, 48,

```

<sup>4</sup><https://reference.wolfram.com/language/ref/Tally.html>

```

108, 114, 102, 14, 121, 115, 31, 9, 117, 113, 111, 5, 4, 127, 28,
122, 101, 8, 110, 14, 18, 124, 106, 16, 20, 104, 119, 8, 109, 26,
106, 9, 97, 13, 99, 15, 119, 20, 105, 117, 98, 103, 118, 1, 126,
29, 97, 122, 17, 15, 114, 110, 3, 5, 125, 125, 99, 126, 119, 102,
30, 122, 2, 117}, 1},
{{80, 1, 74, 59, 113, 45, 56, 86, 52, 91, 19, 64, 60, 60, 63,
25, 38, 59, 59, 42, 14, 53, 38, 77, 66, 38, 113, 38, 75, 4, 43, 84,
63, 101, 64, 43, 79, 64, 40, 57, 16, 91, 46, 119, 69, 40, 84, 117,
9, 97, 13, 99, 15, 119, 20, 105, 117, 98, 103, 118, 1, 126, 29,
97, 122, 17, 15, 114, 110, 3, 5, 125, 125, 99, 126, 119, 102, 30,
122, 2, 117}, 1},
{{80, 2, 74, 49, 113, 49, 51, 92, 39, 8, 92, 81, 116, 62, 57,
80, 46, 40, 114, 36, 75, 56, 33, 76, 9, 55, 56, 59, 81, 65, 45, 28,
60, 55, 93, 39, 90, 28, 124, 106, 16, 20, 104, 119, 8, 109, 26,
106, 9, 97, 13, 99, 15, 119, 20, 105, 117, 98, 103, 118, 1, 126,
29, 97, 122, 17, 15, 114, 110, 3, 5, 125, 125, 99, 126, 119, 102,
30, 122, 2, 117}, 1}}

```

Tally's output is a list of pairs, each pair has 81-byte block and number of times it has been occurred in the file. We see that the most frequent block is the first, it has been occurred 1739 times. The second one has been occurred 1422 times. There are others: 1012 times, 377 times, etc. 81-byte blocks which has been occurred just once are at the end of output.

Let's try to compare these blocks. The first and the second. Is there a function in Mathematica which compares lists/arrays? Certainly is, but for educational purposes, I'll use XOR operation for comparison. Indeed: if bytes in two input arrays are identical, XOR result is 0. If they are non-equal, result will be non-zero.

Let's compare first block (occurred 1739 times) and the second (occurred 1422 times):

```

In[]:= BitXor[stat[[1]][[1]], stat[[2]][[1]]]
Out[]:= {0, 3, 0, 0, 0, 0, 0, 0, 0, 0, 0, 0, 0, 0, 0, 0, 0, 0, \
0, 0, 0, 0, 0, 0, 0, 0, 0, 0, 0, 0, 0, 0, 0, 0, 0, 0, \
0, 0, 0, 0, 0, 0, 0, 0, 0, 0, 0, 0, 0, 0, 0, 0, 0, 0, \
0, 0, 0, 0, 0, 0, 0, 0, 0, 0, 0, 0, 0, 0, 0, 0, 0, 0}

```

They are differ only in the second byte.

Let's compare the second block (occurred 1422 times) and the third (occurred 1012 times):

```

In[]:= BitXor[stat[[2]][[1]], stat[[3]][[1]]]
Out[]:= {0, 1, 0, 0, 0, 0, 0, 0, 0, 0, 0, 0, 0, 0, 0, 0, 0, 0, \
0, 0, 0, 0, 0, 0, 0, 0, 0, 0, 0, 0, 0, 0, 0, 0, 0, 0, \
0, 0, 0, 0, 0, 0, 0, 0, 0, 0, 0, 0, 0, 0, 0, 0, 0, 0, \
0, 0, 0, 0, 0, 0, 0, 0, 0, 0, 0, 0, 0, 0, 0, 0, 0, 0}

```

They are also differ only in the second byte.

Anyway, let's try to use the most occurred block as a XOR key and try to decrypt four first 81-byte blocks in the file:

```

In[]:= key = stat[[1]][[1]]
Out[]:= {80, 103, 2, 116, 113, 102, 118, 25, 99, 8, 19, 23, 116, \
125, 107, 25, 99, 109, 114, 102, 14, 121, 115, 31, 9, 117, 113, 111, \
5, 4, 127, 28, 122, 101, 8, 110, 14, 18, 124, 106, 16, 20, 104, 119, \
8, 109, 26, 106, 9, 97, 13, 99, 15, 119, 20, 105, 117, 98, 103, 118, \
1, 126, 29, 97, 122, 17, 15, 114, 110, 3, 5, 125, 125, 99, 126, 119, \
102, 30, 122, 2, 117}

In[]:= ToASCII[val_] := If[val == 0, " ", FromCharacterCode[val, "PrintableASCII"]]

In[]:= DecryptBlockASCII[blk_] := Map[ToASCII[#] &, BitXor[key, blk]]

In[]:= DecryptBlockASCII[blocks[[1]]]
Out[]:= {" ", " ", " ", " ", " ", " ", " ", " ", " ", " ", " ", " ", " ", " ", " \
", " ", " ", " ", " ", " ", " ", " ", " ", " ", " ", " ", " ", " ", " ", " \

```





```

RE-book/decrypt_dat_file/tmp                                4011/1620K                                0%
.....eHE.WEED.OF
TTER.FRUIT.....fHO.KNOWS.WHAT.EVIL.LURKS.IN.THE.HE
.....eHE.sHADOW.KNOWS.....
.....x.HAVE.THE.HEART.OF.A.CHILD.....
P.IT.IN.A.GLASS.JAR.ON.MY.DESK.....uEVERON.....
.....fHERE.THE.sHADOW.LIES.....
.....pLL.POSITIONING.IS.relative.AND.NOT.absolute.....
.....eHIS.IS.A.KLUDGE.TO.MAKE.THIS.STUPID.THING.WORK.....
.....cELAX
Y.....cLOCK.TICKS.AWAY.....
.....uEBUGGING.pROGRAMS.IS.FUN...s
AD
K.WALLS.....
.....pND.FROM.WITHIN.THE.TOMB.OF.THE.UNDEAD..VAMPIRES.BEGAN.THEIR.FEA
..EORTURED.CRIES.RANG.OUT....tASTES.GREAT..lESS.FILLING.....
.....BUDDENL
RAITHLIKE.FIGURE.APPEARS.BEFORE.YOU..SEEMING.TO.....WLOAT.IN.THE.AIR...
MFUL.VOICE.HE.SAYS...aLAS..THE.VERY.....ATURE.OF.THE.WORLD.HAS.CHANGED
DN.CANNOT.BE.FOUND...aLL.....\UST.NOW.PASS.AWAY...rRAISING.HIS.OAKEN.STA
HE.FADES.INTO.....EHE.SPREADING.DARKNESS...in.HIS.PLACE.APPEARS.A.TASTEFU
GN.....CEADING.....

```

Figure 9.9: Decrypted file in Midnight Commander, 1st attempt

Looks like some kind of English phrases from some game, but something wrong. First of all, cases are inverted: phrases and some words are started with lowercase characters, while other characters are in upper case. Also, some phrases started with wrong letters. Take a look at the very first phrase: “eHE WEED OF CRIME BEARS BITTER FRUIT”. What is “eHE”? Isn’t “tHE” have to be here? Is it possible that our decryption key has wrong byte at this place?

Let’s look again at the second block in the file, at key and at decryption result:

```

In[]:= blocks[[2]]
Out[]= {80, 2, 74, 49, 113, 49, 51, 92, 39, 8, 92, 81, 116, 62, \
57, 80, 46, 40, 114, 36, 75, 56, 33, 76, 9, 55, 56, 59, 81, 65, 45, \
28, 60, 55, 93, 39, 90, 28, 124, 106, 16, 20, 104, 119, 8, 109, 26, \
106, 9, 97, 13, 99, 15, 119, 20, 105, 117, 98, 103, 118, 1, 126, 29, \
97, 122, 17, 15, 114, 110, 3, 5, 125, 125, 99, 126, 119, 102, 30, \
122, 2, 117}

In[]:= key
Out[]= {80, 103, 2, 116, 113, 102, 118, 25, 99, 8, 19, 23, 116, \
125, 107, 25, 99, 109, 114, 102, 14, 121, 115, 31, 9, 117, 113, 111, \
5, 4, 127, 28, 122, 101, 8, 110, 14, 18, 124, 106, 16, 20, 104, 119, \
8, 109, 26, 106, 9, 97, 13, 99, 15, 119, 20, 105, 117, 98, 103, 118, \
1, 126, 29, 97, 122, 17, 15, 114, 110, 3, 5, 125, 125, 99, 126, 119, \
102, 30, 122, 2, 117}

In[]:= BitXor[key, blocks[[2]]]
Out[]= {0, 101, 72, 69, 0, 87, 69, 69, 68, 0, 79, 70, 0, 67, 82, \
73, 77, 69, 0, 66, 69, 65, 82, 83, 0, 66, 73, 84, 84, 69, 82, 0, 70, \
82, 85, 73, 84, 14, 0, 0, 0, 0, 0, 0, 0, 0, 0, 0, 0, 0, 0, 0, \
0, 0, 0, 0, 0, 0, 0, 0, 0, 0, 0, 0, 0, 0, 0, 0, 0, 0, 0, 0, \
0, 0, 0}

```

Encrypted byte is 2, the byte from the key is 103,  $2 \oplus 103 = 101$  and 101 is ASCII code for “e” character. What byte of a key must be equal to, so the resulting ASCII code will be 116 (for “t” character)?  $2 \oplus 116 = 118$ , let’s put 118 in key at the second byte ...

```
key = {80, 118, 2, 116, 113, 102, 118, 25, 99, 8, 19, 23, 116, 125,
      107, 25, 99, 109, 114, 102, 14, 121, 115, 31, 9, 117, 113, 111, 5,
      4, 127, 28, 122, 101, 8, 110, 14, 18, 124, 106, 16, 20, 104, 119, 8,
      109, 26, 106, 9, 97, 13, 99, 15, 119, 20, 105, 117, 98, 103, 118,
      1, 126, 29, 97, 122, 17, 15, 114, 110, 3, 5, 125, 125, 99, 126, 119,
      102, 30, 122, 2, 117}
```

...and decrypt the whole file again.

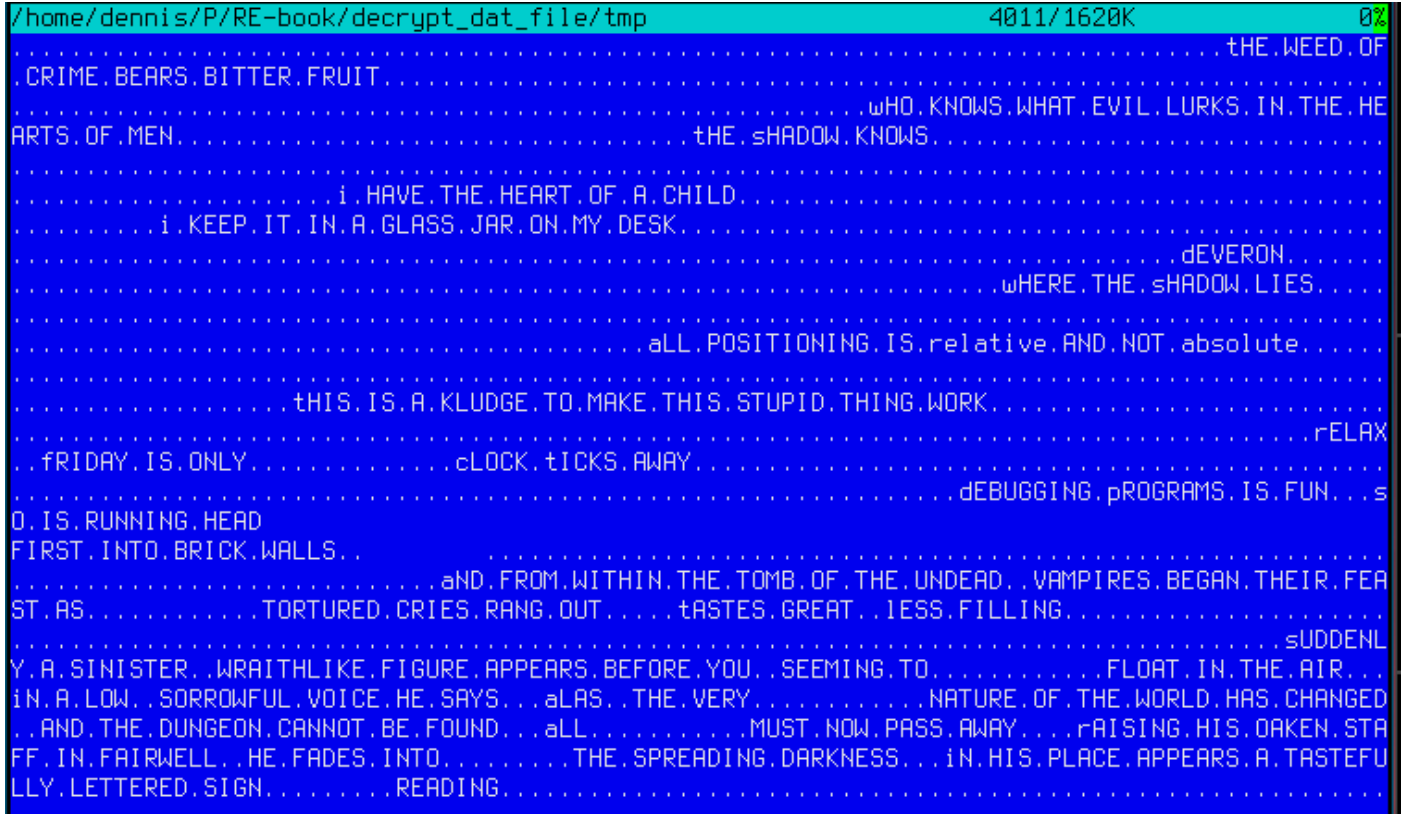

Figure 9.10: Decrypted file in Midnight Commander, 2nd attempt

Wow, now the grammar is correct, all phrases started with correct letters. But still, case inversion is suspicious. Why would game’s developer write them in such a manner? Maybe our key is still incorrect?

While observing ASCII table we can notice that uppercase and lowercase letter’s ASCII codes are differ in just one bit (6th bit starting at 1st, 0b100000):

Characters in the coded character set ascii.

	0	1	2	3	4	5	6	7	8	9	A	B	C	D	E	F
0x	C-@	C-a	C-b	C-c	C-d	C-e	C-f	C-g	C-h	TAB	C-j	C-k	C-l	RET	C-n	C-o
1x	C-p	C-q	C-r	C-s	C-t	C-u	C-v	C-w	C-x	C-y	C-z	ESC	C-\	C-]	C-^	C-_
2x	!	"	#	\$	%	&	'	(	)	*	+	,	-	.	/	
3x	0	1	2	3	4	5	6	7	8	9	:	;	<	=	>	?
4x	@	A	B	C	D	E	F	G	H	I	J	K	L	M	N	O
5x	P	Q	R	S	T	U	V	W	X	Y	Z	[	\	]	^	
6x	`	a	b	c	d	e	f	g	h	i	j	k	l	m	n	o
7x	p	q	r	s	t	u	v	w	x	y	z	{		}	~	DEL

Figure 9.11: 7-bit ASCII table in Emacs

6th bit set in a zero byte has decimal form of 32. But 32 is ASCII code for space!

Indeed, one can switch case just by XOR-ing ASCII character code with 32 (more about it: [3.19.3 on page 540](#)).

It is possible that the empty lacunas in the file are not zero bytes, but rather spaces? Let's modify XOR key one more time (I'll XOR each byte of key by 32):

```
(* "32" is scalar and "key" is vector, but that's OK *)
In[]:= key3 = BitXor[32, key]
Out[]= {112, 86, 34, 84, 81, 70, 86, 57, 67, 40, 51, 55, 84, 93, 75, \
57, 67, 77, 82, 70, 46, 89, 83, 63, 41, 85, 81, 79, 37, 36, 95, 60, \
90, 69, 40, 78, 46, 50, 92, 74, 48, 52, 72, 87, 40, 77, 58, 74, 41, \
65, 45, 67, 47, 87, 52, 73, 85, 66, 71, 86, 33, 94, 61, 65, 90, 49, \
47, 82, 78, 35, 37, 93, 93, 67, 94, 87, 70, 62, 90, 34, 85}
In[]:= DecryptBlock[blk_] := BitXor[key3, blk]
```

Let's decrypt the input file again:

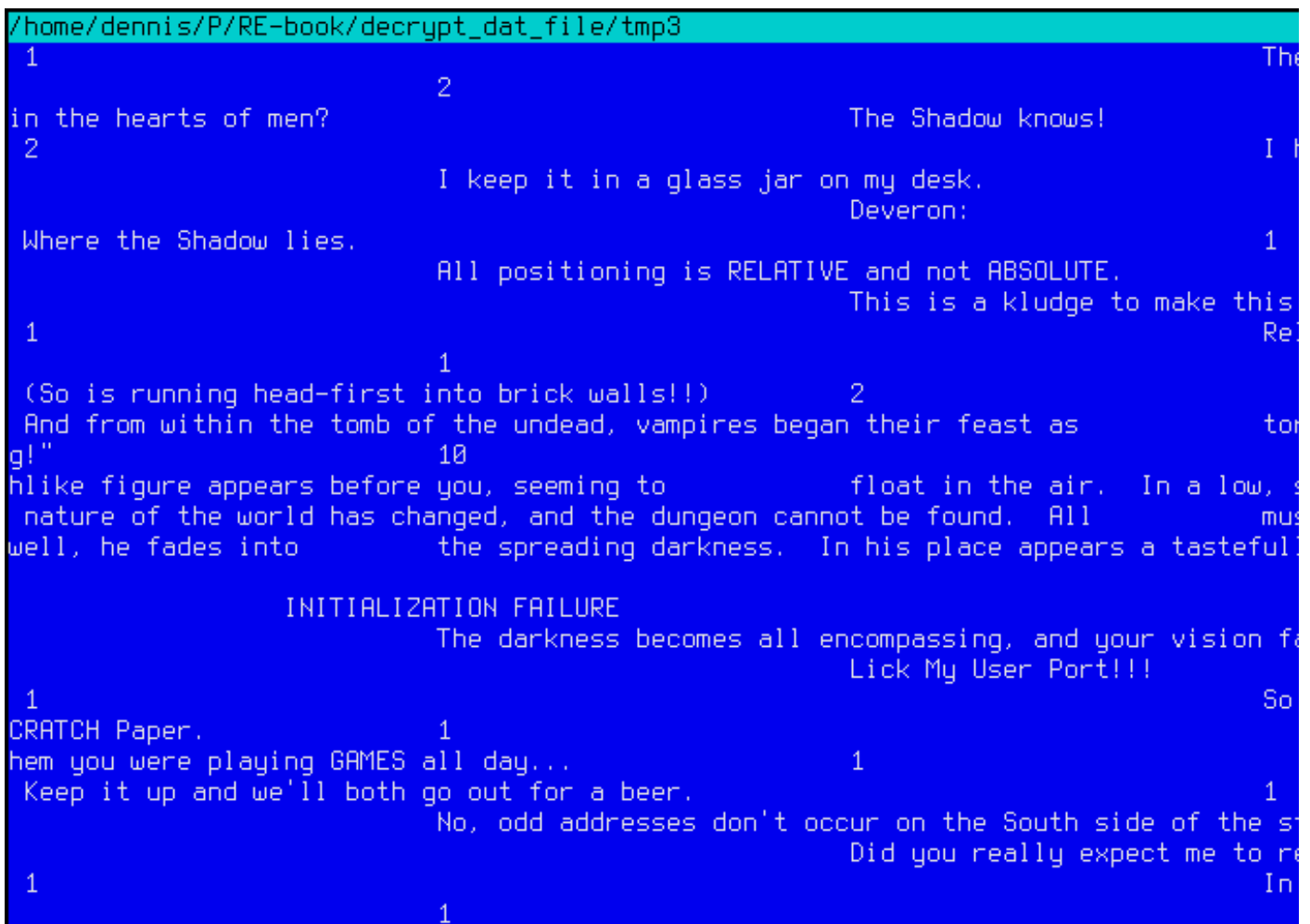

Figure 9.12: Decrypted file in Midnight Commander, final attempt

(Decrypted file is available here: [https://beginners.re/current-tree/ff/XOR/mask\\_1/files/decrypted.dat.bz2](https://beginners.re/current-tree/ff/XOR/mask_1/files/decrypted.dat.bz2).)

This is undoubtedly a correct source file. Oh, and we see numbers at the start of each block. It has to be a source of our erroneous XOR key. As it seems, the most occurred 81-byte block in the file is a block filled with spaces and containing "1" character at the place of second byte. Indeed, somehow, many blocks here are interleaved with this one. Maybe it's some kind of padding for short phrases/messages? Other frequently occurred 81-byte blocks are also space-filled blocks, but with different digit, hence, they are differ only at the second byte.

That's all! Now we can write an utility to encrypt the file back, and maybe modify it before.

Mathematica notebook file is downloadable here:

[https://beginners.re/current-tree/ff/XOR/mask\\_1/files/XOR\\_mask\\_1.nb](https://beginners.re/current-tree/ff/XOR/mask_1/files/XOR_mask_1.nb).

Summary: XOR encryption like that is not robust at all. It has been intended by game's developer(s), probably, just to prevent gamer(s) to peek into internals of game, nothing else more serious. Still, encryption like that is extremely popular due to its simplicity and many reverse engineers are usually familiar with it.

### 9.1.5 Simple encryption using XOR mask, case II

I've got another encrypted file, which is clearly encrypted by something simple, like XOR-ing:

```

/home/dennis/tmp/cipher.txt 0x00000000
00000000 DD D2 0F 70 1C E7 9E 8D E9 EC AC 3D 61 5A 15 95 .p.膊 =aZ.
00000010 5C F5 D3 0D 70 38 E7 94 DF F2 E2 BC 76 34 61 0F \ .p8 v4a.
00000020 98 5D FC D9 01 26 2A FD 82 DF E9 E2 BB 33 61 7B ] .&* 3a{
00000030 14 D9 45 F8 C5 01 3D 20 FD 95 96 EB E4 BC 7A 61 . E . = za
00000040 61 1B 8F 54 9D AA 54 20 20 E1 DB 8B ED EC BC 33 a. T T 3
00000050 61 7C 15 8D 11 F9 CE 47 22 2A FE 8E 9A EB F7 EF al. . G"*
00000060 39 22 71 1B 8A 58 FF CE 52 70 38 E7 9E 91 A5 EB 9"q. X Rp8
00000070 AA 76 36 73 09 D9 44 E0 80 40 3C 23 AF 95 96 E2 v6s. D @<#
00000080 EB 8B 7A 61 65 1B 8A 11 E3 C5 40 24 2A EB F6 F5 zae. . @$*
00000090 E4 F7 EF 22 29 77 5A 9B 43 F5 C1 4A 36 2E FC 8F ")wZ C J6.
000000A0 DF F1 E2 AD 3A 24 3C 5A B0 11 E3 D4 4E 3F 2B AF :$<Z . N?+
000000B0 8E 8F EA ED EF 22 29 77 5A 91 54 F1 D2 55 38 62 ")wZ T U8b
000000C0 FD 8E 98 A5 E2 A1 32 61 62 13 9A 5A F5 C4 01 25 2ab. Z .%
000000D0 3F AF 8F 97 E0 8E C5 25 35 7B 19 92 11 E7 C8 48 ? %5(. . H
000000E0 33 27 AF 94 8A F7 A3 B9 3F 32 7B 0E 96 43 B0 C8 3' ?2(. C
000000F0 40 34 6F E3 9E 99 F1 A3 AD 33 29 7B 14 9D 11 F8 @4o屮 3)(. .
00000100 C9 4C 70 3B E7 9E DF EB EA A8 3E 35 32 18 9C 57 Lp; >52. W
00000110 FF D2 44 7E 6F C6 8F DF F2 E2 BC 76 20 1F 70 9F D~o0 v .p
00000120 58 FE C5 0D 70 3B E7 92 9C EE A3 BF 3F 24 71 1F X .p;璠 冂 ?$q.
00000130 D9 5E F6 80 56 3F 20 EB D7 DF E7 F6 A3 34 2E 67 ^ V? 4.g
00000140 09 D4 59 F5 C1 45 35 2B A3 DB 90 E3 A3 BB 3E 24 . Y E5+ 茶 >$
00000150 32 09 96 43 E4 80 56 38 26 EC 93 DF EC F0 EF 3D 2. C V8& =
00000160 2F 7D 0D 97 11 F1 D3 2C 5A 2E AF D9 AF E0 ED AE /). . ,Z.
00000170 38 26 32 16 98 46 E9 C5 53 7E 6D AF B1 8A F6 F7 8&2. F S~m
00000180 EF 23 2F 76 1F 8B 11 E4 C8 44 70 27 EA 9A 9B A5 #/v. . Dp'.
00000190 F4 AE 25 61 73 5A 9B 43 FF C1 45 70 3C E6 97 89 %asZ C Ep<屮
000001A0 E0 F1 EF 34 20 7C 1E D9 5F F5 C1 53 3C 36 82 F1 4 l. _ S<6
000001B0 9E EB A3 A6 38 22 7A 5A 98 52 E2 CF 52 23 61 AF 孛 8"zZ R R#a
000001C0 D9 AB EA A3 85 37 2C 77 09 D9 7C FF D2 55 39 22 . 7,w. l U9"
000001D0 EA 89 D3 A5 CE E1 04 6F 51 54 AA 1F BC 80 47 22 ü .oQT . G"
000001E0 20 E2 DB 97 EC F0 EF 30 33 7B 1F 97 55 E3 80 4E 03(. U N
000001F0 36 6F FB 93 9A 88 89 8C 78 02 3C 32 D7 1D B2 80 6o x.<2 .

```

Figure 9.13: Encrypted file in Midnight Commander

The encrypted file can be downloaded [here](#).

ent Linux utility reports about ~7.5 bits per byte, and this is high level of entropy ( 9.2 on page 944), close to compressed or properly encrypted file. But still, we clearly see some pattern, there are some blocks with size of 17 bytes, and you can see some kind of ladder, shifting by 1 byte at each 16-byte line.

It's also known that the plain text is just English language text.

Now let's assume that this piece of text is encrypted by simple XOR-ing with 17-byte key.

I tried to find some repeating 17-byte blocks using Mathematica, like I did before in my previous example ( 9.1.4 on page 931):

### Listing 9.2: Mathematica

```
In[]:=input = BinaryReadList["/home/dennis/tmp/cipher.txt"];
In[]:=blocks = Partition[input, 17];
In[]:=Sort[Tally[blocks], #1[[2]] > #2[[2]] &]

Out[]:={{{248,128,88,63,58,175,159,154,232,226,161,50,97,127,3,217,80},1},
{{226,207,67,60,42,226,219,150,246,163,166,56,97,101,18,144,82},1},
{{228,128,79,49,59,250,137,154,165,236,169,118,53,122,31,217,65},1},
{{252,217,1,39,39,238,143,223,241,235,170,91,75,119,2,152,82},1},
{{244,204,88,112,59,234,151,147,165,238,170,118,49,126,27,144,95},1},
{{241,196,78,112,54,224,142,223,242,236,186,58,37,50,17,144,95},1},
{{176,201,71,112,56,230,143,151,234,246,187,118,44,125,8,156,17},1},
...
{{255,206,82,112,56,231,158,145,165,235,170,118,54,115,9,217,68},1},
{{249,206,71,34,42,254,142,154,235,247,239,57,34,113,27,138,88},1},
{{157,170,84,32,32,225,219,139,237,236,188,51,97,124,21,141,17},1},
{{248,197,1,61,32,253,149,150,235,228,188,122,97,97,27,143,84},1},
{{252,217,1,38,42,253,130,223,233,226,187,51,97,123,20,217,69},1},
{{245,211,13,112,56,231,148,223,242,226,188,118,52,97,15,152,93},1},
{{221,210,15,112,28,231,158,141,233,236,172,61,97,90,21,149,92},1}}
```

No luck, each 17-byte block is unique within the file and occurred only once. Perhaps, there are no 17-byte zero lacunas, or lacunas containing only spaces. It is possible indeed: such long space indentation and padding may be absent in tightly typeset text.

The first idea is to try all possible 17-byte keys and find those, which will result in readable text after decryption. Bruteforce is not an option, because there are  $256^{17}$  possible keys ( $\sim 10^{40}$ ), that's too much. But there are good news: who said we have to test 17-byte key as a whole, why can't we test each byte of key separately? It is possible indeed.

Now the algorithm is:

- try all 256 bytes for 1st byte of key;
- decrypt 1st byte of each 17-byte blocks in the file;
- are all decrypted bytes we got are printable? keep tabs on it;
- do so for all 17 bytes of key.

I've written the following Python script to check this idea:

### Listing 9.3: Python script

```
each_nth_byte=[""]*KEY_LEN

content=read_file(sys.argv[1])
# split input by 17-byte chunks:
all_chunks=chunks(content, KEY_LEN)
for c in all_chunks:
    for i in range(KEY_LEN):
        each_nth_byte[i]=each_nth_byte[i] + c[i]

# try each byte of key
for N in range(KEY_LEN):
    print "N=", N
    possible_keys=[]
    for i in range(256):
        tmp_key=chr(i)*len(each_nth_byte[N])
        tmp=xor_strings(tmp_key,each_nth_byte[N])
        # are all characters in tmp[] are printable?
        if is_string_printable(tmp)==False:
            continue
        possible_keys.append(i)
    print possible_keys, "len=", len(possible_keys)
```

(Full version of the source code is [here](#).)

Here is its output:

```
N= 0
[144, 145, 151] len= 3
N= 1
[160, 161] len= 2
N= 2
[32, 33, 38] len= 3
N= 3
[80, 81, 87] len= 3
N= 4
[78, 79] len= 2
N= 5
[142, 143] len= 2
N= 6
[250, 251] len= 2
N= 7
[254, 255] len= 2
N= 8
[130, 132, 133] len= 3
N= 9
[130, 131] len= 2
N= 10
[206, 207] len= 2
N= 11
[81, 86, 87] len= 3
N= 12
[64, 65] len= 2
N= 13
[18, 19] len= 2
N= 14
[122, 123] len= 2
N= 15
[248, 249] len= 2
N= 16
[48, 49] len= 2
```

So there are 2 or 3 possible bytes for each byte of 17-byte key. This is much better than 256 possible bytes for each byte, but still too much. There are up to 1 million of possible keys:

Listing 9.4: Mathematica

```
In[]:= 3*2*3*3*2*2*2*2*3*2*2*3*2*2*2*2*2
Out[]= 995328
```

It's possible to check all of them, but then we must check visually, if the decrypted text is looks like English language text.

Let's also take into consideration the fact that we deal with 1) natural language; 2) English language. Natural languages has some prominent statistical features. First of all, punctuation and word lengths. What is average word length in English language? Let's just count spaces in some well-known English language texts using Mathematica.

Here is "[The Complete Works of William Shakespeare](#)" text file from Gutenberg Library:

Listing 9.5: Mathematica

```
In[]:= input = BinaryReadList["/home/dennis/tmp/pg100.txt"];
In[]:= Tally[input]
Out[]= {{239, 1}, {187, 1}, {191, 1}, {84, 39878}, {104,
218875}, {101, 406157}, {32, 1285884}, {80, 12038}, {114,
209907}, {111, 282560}, {106, 2788}, {99, 67194}, {116,
291243}, {71, 11261}, {117, 115225}, {110, 216805}, {98,
46768}, {103, 57328}, {69, 42703}, {66, 15450}, {107, 29345}, {102,
69103}, {67, 21526}, {109, 95890}, {112, 46849}, {108, 146532}, {87,
```

```

16508}, {115, 215605}, {105, 199130}, {97, 245509}, {83,
34082}, {44, 83315}, {121, 85549}, {13, 124787}, {10, 124787}, {119,
73155}, {100, 134216}, {118, 34077}, {46, 78216}, {89, 9128}, {45,
8150}, {76, 23919}, {42, 73}, {79, 33268}, {82, 29040}, {73,
55893}, {72, 18486}, {68, 15726}, {58, 1843}, {65, 44560}, {49,
982}, {50, 373}, {48, 325}, {91, 2076}, {35, 3}, {93, 2068}, {74,
2071}, {57, 966}, {52, 107}, {70, 11770}, {85, 14169}, {78,
27393}, {75, 6206}, {77, 15887}, {120, 4681}, {33, 8840}, {60,
468}, {86, 3587}, {51, 343}, {88, 608}, {40, 643}, {41, 644}, {62,
440}, {39, 31077}, {34, 488}, {59, 17199}, {126, 1}, {95, 71}, {113,
2414}, {81, 1179}, {63, 10476}, {47, 48}, {55, 45}, {54, 73}, {64,
3}, {53, 94}, {56, 47}, {122, 1098}, {90, 532}, {124, 33}, {38,
21}, {96, 1}, {125, 2}, {37, 1}, {36, 2}

```

```

In[]:= Length[input]/1285884 // N
Out[]= 4.34712

```

There are 1285884 spaces in the whole file, and the frequency of space occurrence is 1 space per ~4.3 characters.

Now here is [Alice's Adventures in Wonderland, by Lewis Carroll](#) from the same library:

#### Listing 9.6: Mathematica

```

In[]:= input = BinaryReadList["/home/dennis/tmp/pg11.txt"];

In[]:= Tally[input]
Out[]:= {{239, 1}, {187, 1}, {191, 1}, {80, 172}, {114, 6398}, {111,
9243}, {106, 222}, {101, 15082}, {99, 2815}, {116, 11629}, {32,
27964}, {71, 193}, {117, 3867}, {110, 7869}, {98, 1621}, {103,
2750}, {39, 2885}, {115, 6980}, {65, 721}, {108, 5053}, {105,
7802}, {100, 5227}, {118, 911}, {87, 256}, {97, 9081}, {44,
2566}, {121, 2442}, {76, 158}, {119, 2696}, {67, 185}, {13,
3735}, {10, 3735}, {84, 571}, {104, 7580}, {66, 125}, {107,
1202}, {102, 2248}, {109, 2245}, {46, 1206}, {89, 142}, {112,
1796}, {45, 744}, {58, 255}, {68, 242}, {74, 13}, {50, 12}, {53,
13}, {48, 22}, {56, 10}, {91, 4}, {69, 313}, {35, 1}, {49, 68}, {93,
4}, {82, 212}, {77, 222}, {57, 11}, {52, 10}, {42, 88}, {83,
288}, {79, 234}, {70, 134}, {72, 309}, {73, 831}, {85, 111}, {78,
182}, {75, 88}, {86, 52}, {51, 13}, {63, 202}, {40, 76}, {41,
76}, {59, 194}, {33, 451}, {113, 135}, {120, 170}, {90, 1}, {122,
79}, {34, 135}, {95, 4}, {81, 85}, {88, 6}, {47, 24}, {55, 6}, {54,
7}, {37, 1}, {64, 2}, {36, 2}

In[]:= Length[input]/27964 // N
Out[]= 5.99049

```

The result is different probably because of different formatting of these texts (maybe indentation and/or padding).

OK, so let's assume the average frequency of space in English language is 1 space per 4..7 characters.

Now the good news again: we can measure frequency of spaces while decrypting our file gradually. Now I count spaces in each *slice* and throw away 1-byte keys which produce results with too small number of spaces (or too large, but this is almost impossible given so short key):

#### Listing 9.7: Python script

```

each_nth_byte=[""]*KEY_LEN

content=read_file(sys.argv[1])
# split input by 17-byte chunks:
all_chunks=chunks(content, KEY_LEN)
for c in all_chunks:
    for i in range(KEY_LEN):
        each_nth_byte[i]=each_nth_byte[i] + c[i]

# try each byte of key

```

```

for N in range(KEY_LEN):
    print "N=", N
    possible_keys=[]
    for i in range(256):
        tmp_key=chr(i)*len(each_Nth_byte[N])
        tmp=xor_strings(tmp_key,each_Nth_byte[N])
        # are all characters in tmp[] are printable?
        if is_string_printable(tmp)==False:
            continue
        # count spaces in decrypted buffer:
        spaces=tmp.count(' ')
        if spaces==0:
            continue
        spaces_ratio=len(tmp)/spaces
        if spaces_ratio<4:
            continue
        if spaces_ratio>7:
            continue
        possible_keys.append(i)
    print possible_keys, "len=", len(possible_keys)

```

(Full version of the source code is [here](#).)

This reports just one single possible byte for each byte of key:

```

N= 0
[144] len= 1
N= 1
[160] len= 1
N= 2
[33] len= 1
N= 3
[80] len= 1
N= 4
[79] len= 1
N= 5
[143] len= 1
N= 6
[251] len= 1
N= 7
[255] len= 1
N= 8
[133] len= 1
N= 9
[131] len= 1
N= 10
[207] len= 1
N= 11
[86] len= 1
N= 12
[65] len= 1
N= 13
[18] len= 1
N= 14
[122] len= 1
N= 15
[249] len= 1
N= 16
[49] len= 1

```

Let's check this key in Mathematica:

#### Listing 9.8: Mathematica

```

In[]:= input = BinaryReadList["/home/dennis/tmp/cipher.txt"];
In[]:= blocks = Partition[input, 17];

```



```
In[]:= key = {144, 160, 33, 80, 79, 143, 251, 255, 133, 131, 207, 86, 65, 18, 122, 249, 49};  
In[]:= EncryptBlock[blk_] := BitXor[key, blk]  
In[]:= encrypted = Map[EncryptBlock[#] &, blocks];  
In[]:= BinaryWrite["/home/dennis/tmp/plain2.txt", Flatten[encrypted]]  
In[]:= Close["/home/dennis/tmp/plain2.txt"]
```

And the plain text is:

```
Mr. Sherlock Holmes, who was usually very late in the mornings, save upon those not infrequent occasions when he was up all night, was seated at the breakfast table. I stood upon the hearth-rug and picked up the stick which our visitor had left behind him the night before. It was a fine, thick piece of wood, bulbous-headed, of the sort which is known as a "Penang lawyer." Just under the head was a broad silver band nearly an inch across. "To James Mortimer, M.R.C.S., from his friends of the C.C.H.," was engraved upon it, with the date "1884." It was just such a stick as the old-fashioned family practitioner used to carry--dignified, solid, and reassuring.
```

```
"Well, Watson, what do you make of it?"
```

```
Holmes was sitting with his back to me, and I had given him no sign of my occupation.
```

```
...
```

(Full version of the text is [here](#).)

The text looks correct. Yes, I made up this example and choose well-known text of Conan Doyle, but it's very close to what I had in my practice some time ago.

## Other ideas to consider

If we would fail with space counting, there are other ideas to try:

- Take into consideration the fact that lowercase letters are much more frequent than uppercase ones.
- Frequency analysis.
- There is also a good technique to detect language of a text: trigrams. Each language has some very frequent letter triplets, these may be "the" and "tha" for English. Read more about it: [N-Gram-Based Text Categorization](http://code.activestate.com/recipes/326576/), <http://code.activestate.com/recipes/326576/>. Interestingly enough, trigrams detection can be used when you decrypt a ciphertext gradually, like in this example (you just have to test 3 adjacent decrypted characters).

For non-Latin writing systems encoded in UTF-8, things may be easier. For example, Russian text encoded in UTF-8 has each byte interleaved with 0xD0/0xD1 byte. It is because Cyrillic characters are placed in 4th block of Unicode table. Other writing systems has their own blocks.

## 9.1.6 Homework

An ancient text adventure for MS-DOS, developed in the end of 1980's. To conceal game information from player, data files, most likely, XOR-ed with something: [https://beginners.re/homework/XOR\\_crypto\\_1/destiny.zip](https://beginners.re/homework/XOR_crypto_1/destiny.zip). Try to get into...

## 9.2 Information entropy

Entropy: The quantitative measure of disorder, which in turn relates to the thermodynamic functions, temperature, and heat.

Dictionary of Applied Math for Engineers and Scientists

For the sake of simplification, I would say, information entropy is a measure, how tightly some piece of data can be compressed. For example, it is usually not possible to compress already compressed archive file, so it has high entropy. On the other hand, 1MiB of zero bytes can be compressed to a tiny output file. Indeed, in plain English language, one million of zeros can be described just as “resulting file is one million zero bytes”. Compressed files are usually a list of instructions to decompressor, like this: “put 1000 zeros, then 0x23 byte, then 0x45 byte, then put a block of size 10 bytes which we’ve seen 500 bytes back, etc.”

Texts written in natural languages are also can be compressed tightly, because natural languages has a lot of redundancy (otherwise, a tiny typo will always lead to misunderstanding, like any toggled bit in compressed archive make decompression nearly impossible), some words are used very often, etc. In everyday speech, it’s possible to drop up to half of words and it still be recognizable.

Code for CPUs is also can be compressed, because some ISA instructions are used much more often than others. In x86, most used instructions are MOV/PUSH/CALL ( 5.11.2 on page 734).

Data compressors and ciphers tend to produce very high entropy results. Good PRNG also produce data which cannot be compressed (it is possible to measure their quality by this sign).

So, in other words, entropy is a measure which can help to probe contents of unknown data block.

### 9.2.1 Analyzing entropy in Mathematica

(This part has been first appeared in my blog at 13-May-2015. Some discussion: <https://news.ycombinator.com/item?id=9545276>.)

It is possible to slice a file by blocks, calculate entropy of each and draw a graph. I did this in Wolfram Mathematica for demonstration and here is a source code (Mathematica 10):

```
(* loading the file *)
input=BinaryReadList["file.bin"];

(* setting block sizes *)
BlockSize=4096;BlockSizeToShow=256;

(* slice blocks by 4k *)
blocks=Partition[input,BlockSize];

(* how many blocks we've got? *)
Length[blocks]

(* calculate entropy for each block. 2 in Entropy[] (base) is set with the intention so Entropy↵
↳ []
function will produce the same results as Linux ent utility does *)
entropies=Map[N[Entropy[2,#]]&,blocks];

(* helper functions *)
fBlockToShow[input_,offset_]:=Take[input,{1+offset,1+offset+BlockSizeToShow}]
fToASCII[val_]:=FromCharacterCode[val,"PrintableASCII"]
fToHex[val_]:=IntegerString[val,16]
fPutASCIIWindow[data_]:=Framed[Grid[Partition[Map[fToASCII,data],16]]]
fPutHexWindow[data_]:=Framed[Grid[Partition[Map[fToHex,data],16],Alignment->Right]]

(* that will be the main knob here *)
{Slider[Dynamic[offset],{0,Length[input]-BlockSize,BlockSize}],Dynamic[BaseForm[offset,16]]}

(* main UI part *)
Dynamic[{{ListLinePlot[entropies,GridLines->{{-1,offset/BlockSize,1}},Filling->Axis,AxesLabel->{↵
↳ "offset","entropy"}},
```

```
CurrentBlock=fBlockToShow[input,offset];
fPutHexWindow[CurrentBlock],
fPutASCIIWindow[CurrentBlock]}}
```

### GeoIP ISP database

Let's start with the [GeoIP](#) file (which assigns ISP to the block of IP addresses). This binary file *GeoIPISP.dat* has some tables (which are IP address ranges perhaps) plus some text blob at the end of the file (containing ISP names).

When I load it to Mathematica, I see this:

```
In[68]:= (* that will be the main knob here *)
Slider[Dynamic[offset], {0, Length[input] - BlockSize, BlockSize}]

Out[68]:= {Slider, f700016}

In[59]:= (* main UI part *)
Dynamic[{ListLinePlot[entropies, GridLines -> {{-1, offset/BlockSize}
CurrentBlock = fBlockToShow[input, offset];
fPutHexWindow[CurrentBlock], fPutASCIIWindow[CurrentBlock]}]}
```

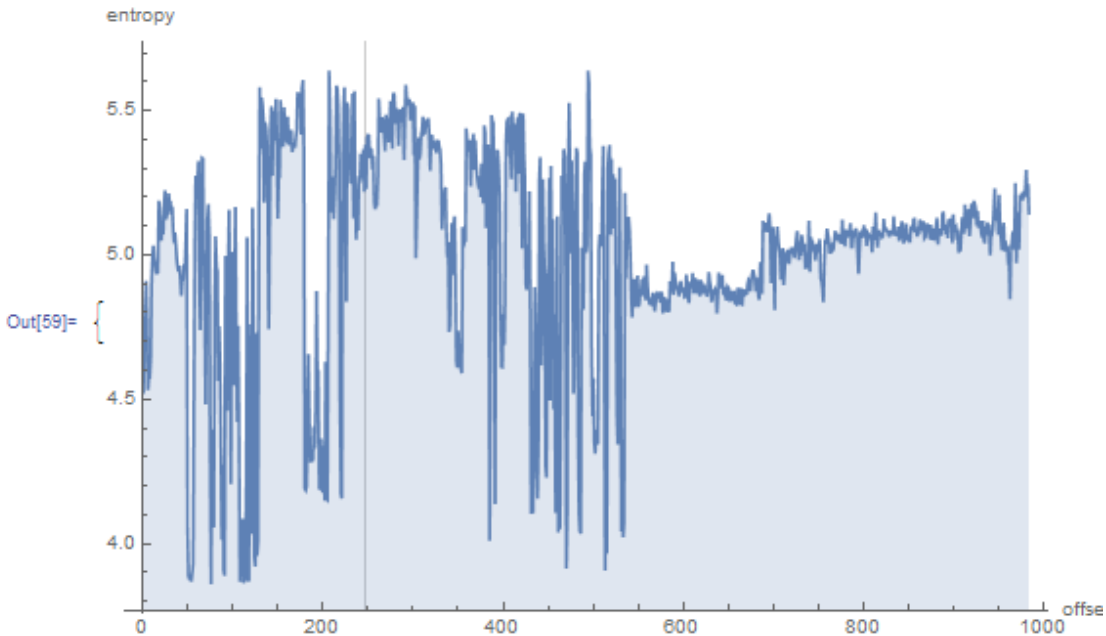

1 ee 1 0 76 eb 5 0 17 c0 5 0 f3 de 5 0	0 0 0 0 v 0 0 0 0 0 0 0 0 0 0 0 0
76 eb 5 0 3 ee 1 0 4 ee 1 0 5 ee 1 0	v 0 0 0 0 0 0 0 0 0 0 0 0 0 0 0 0
76 eb 5 0 aa 6c 6 0 fd 2c 4 0 64 59 14 0	v 0 0 0 0 1 0 0 0 , 0 0 d Y 0 0
7 ee 1 0 a ee 1 0 64 59 14 0 8 ee 1 0	0 0 0 0 0 0 0 0 d Y 0 0 0 0 0 0
64 59 14 0 9 ee 1 0 f0 3d 6 0 4c d3 6 0	d Y 0 0 0 0 0 0 0 0 = 0 0 L 0 0 0
b ee 1 0 e ee 1 0 c ee 1 0 d ee 1 0	0 0 0 0 0 0 0 0 0 0 0 0 0 0 0 0
4e bc 6 0 17 45 6 0 fd 2c 4 0 b6 ed 4 0	N 0 0 0 0 0 E 0 0 0 , 0 0 0 0 0 0
f ee 1 0 10 ee 1 0 fd 2c 4 0 f3 a3 5 0	0 0 0 0 0 0 0 0 0 0 , 0 0 0 0 0 0
8d df 5 0 2 dc 6 0 12 ee 1 0 2c ee 1 0	0 0 0 0 0 0 0 0 0 0 0 0 0 0 , 0 0 0
13 ee 1 0 1d ee 1 0 40 14 6 0 14 ee 1 0	0 0 0 0 0 0 0 0 0 0 @ 0 0 0 0 0 0
15 ee 1 0 19 ee 1 0 40 14 6 0 16 ee 1 0	0 0 0 0 0 0 0 0 0 0 @ 0 0 0 0 0 0
17 ee 1 0 18 ee 1 0 6 45 6 0 30 35 6 0	0 0 0 0 0 0 0 0 0 0 E 0 0 0 0 5 0
c 2f 6 0 d 44 6 0 1a ee 1 0 54 52 14 0	0 / 0 0 D 0 0 0 0 0 0 0 0 T R 0 0
1b ee 1 0 1c ee 1 0 e2 f8 6 0 fd 2c 4 0	0 0 0 0 0 0 0 0 0 0 0 0 0 0 , 0 0
28 c4 6 0 ee e0 5 0 1e ee 1 0 6b dc e 0	( 0 0 0 0 0 0 0 0 0 0 0 0 k 0 0 0
1f ee 1 0 25 ee 1 0 20 ee 1 0 22 ee 1 0	0 0 0 0 % 0 0 0 0 0 0 " 0 0 0 0

There are two parts in graph: first is somewhat chaotic, second is more steady.  
 0 in horizontal axis in graph means lowest entropy (the data which can be compressed very tightly, *ordered* in other words) and 8 is highest (cannot be compressed at all, *chaotic* or *random* in other words). Why 0

and 8? 0 means 0 bits per byte (byte as a container is not filled at all) and 8 means 8 bits per byte, i.e., the whole byte container is filled with the information tightly.

So I put slider to point in the middle of the first block, and I clearly see some array of 32-bit integers. Now I put slider in the middle of the second block and I see English text:

```
In[88]:= (* that will be the main knob here *)
         {Slider[Dynamic[offset], {0, Length[input] - BlockSize, BlockSize}]

Out[88]= { , 26d00016 }
```

```
In[59]:= (* main UI part *)
         Dynamic[{ListLinePlot[entropies, GridLines -> {{-1, offset/BlockSize}
         CurrentBlock = fBlockToShow[input, offset];
         fPutHexWindow[CurrentBlock], fPutASCIIWindow[CurrentBlock]]}]
```

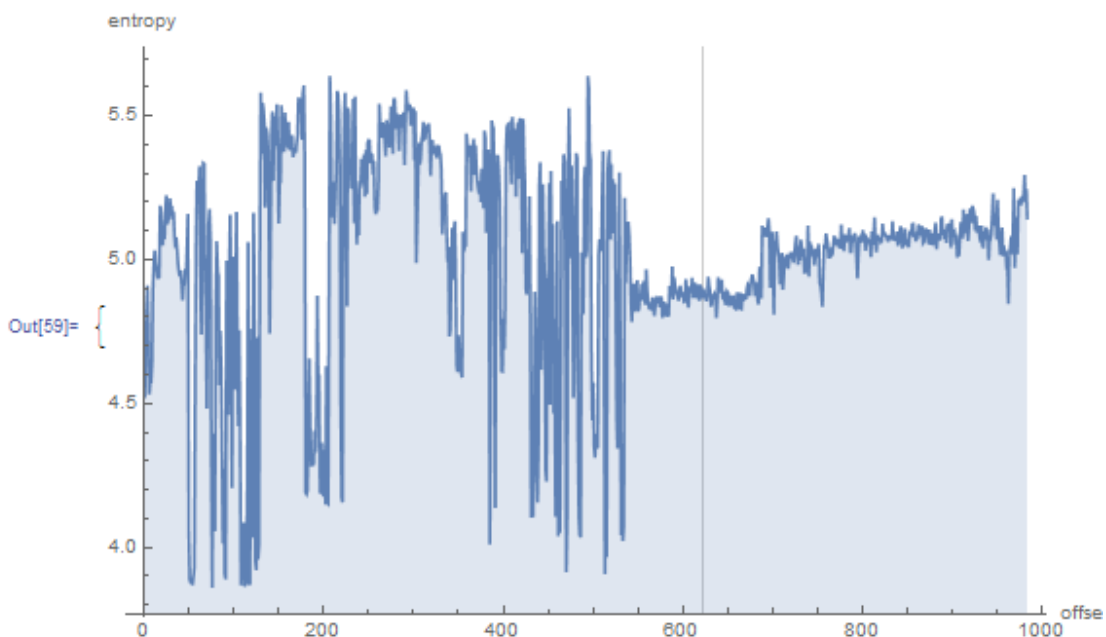

6c 69 73 68 69 6e 67 20 43 6f 6d 70 61 6e 79 0	l i s h i n g C o m p a n y
43 61 6e 76 61 73 20 54 65 63 68 6e 6f 6c 6f 67	C a n v a s T e c h n o l o g
79 0 43 6f 6c 75 6d 62 75 73 20 4d 69 64 64 6c	y C o l u m b u s M i d d l
65 20 53 63 68 6f 6f 6c 0 43 6f 61 73 74 61 6c	e S c h o o l C o a s t a l
20 57 69 72 65 20 26 20 43 61 62 6c 65 0 43 75	W i r e & C a b l e C u
72 72 65 6e 65 78 0 41 75 67 75 73 74 20 53 6f	r r e n e x A u g u s t S o
66 74 77 61 72 65 20 43 6f 72 70 6f 72 61 74 69	f t w a r e C o r p o r a t i
6f 6e 0 41 6d 65 72 69 63 61 6e 20 41 75 74 6f	o n A m e r i c a n A u t o
6d 6f 62 69 6c 65 20 41 73 73 6f 63 69 61 74 69	m o b i l e A s s o c i a t i
6f 6e 20 4e 61 74 6f 69 6e 61 6c 20 4f 66 66 69	o n N a t o i n a l O f f i
63 65 0 41 63 75 72 65 78 20 45 6e 76 69 72 6f	c e A c u r e x E n v i r o
6e 6d 65 6e 74 61 6c 20 43 6f 72 70 2e 0 50 72	n m e n t a l C o r p . P r
69 6e 63 65 20 43 6f 72 70 6f 72 61 74 69 6f 6e	i n c e C o r p o r a t i o n
0 47 6f 32 74 65 6c 2e 63 6f 6d 0 45 6d 70 6c	G o 2 t e l . c o m E m p l
6f 79 6d 65 6e 74 20 53 65 63 75 72 69 74 79 20	o y m e n t S e c u r i t y
43 6f 6d 6d 69 73 73 69 6f 6e 0 47 6c 6f 62 61	C o m m i s s i o n G l o b a

Indeed, this are names of ISPs. So, entropy of English text is 4.5-5.5 bits per byte? Yes, something like this. Wolfram Mathematica has some well-known English literature corpus embedded, and we can see entropy of Shakespeare's sonnets:

```
In[ ]:= Entropy[2,ExampleData[{"Text", "ShakespearesSonnets"}]]//N
Out[ ]= 4.42366
```

4.4 is close to what we've got (4.7-5.3). Of course, classic English literature texts are somewhat different from ISP names and other English texts we can find in binary files (debugging/logging/error messages), but this value is close.

## TP-Link WR941 firmware

Next example. I've got firmware for TP-Link WR941 router:

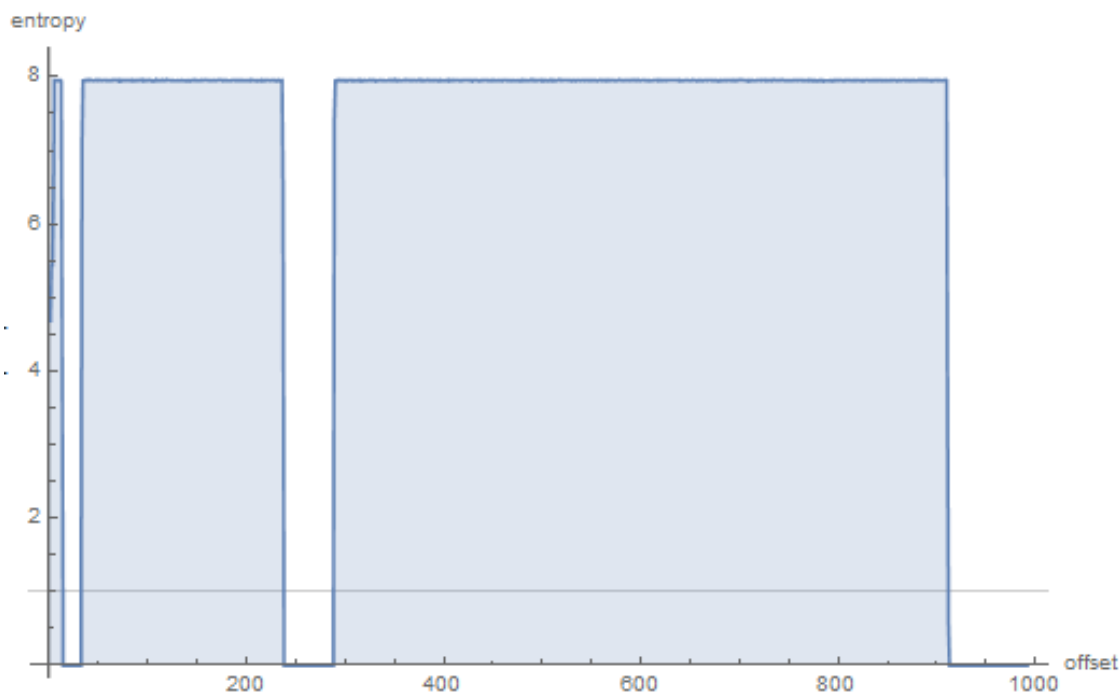

We see here 3 blocks with empty lacunas. Then the first block with high entropy (started at address 0) is small, second (address somewhere at 0x22000) is bigger and third (address 0x123000) is biggest. I can't be sure about exact entropy of the first block, but 2nd and 3rd has very high entropy, meaning that these blocks are either compressed and/or encrypted.

I tried [binwalk](#) for this firmware file:

DECIMAL	HEXADECIMAL	DESCRIPTION
0	0x0	TP-Link firmware header, firmware version: 0.-15221.3, image ↵ ↳ version: "", product ID: 0x0, product version: 155254789, kernel load address: 0x0, ↵ ↳ kernel entry point: 0x-7FFFE000, kernel offset: 4063744, kernel length: 512, rootfs ↵ ↳ offset: 837431, rootfs length: 1048576, bootloader offset: 2883584, bootloader length: 0
14832	0x39F0	U-Boot version string, "U-Boot 1.1.4 (Jun 27 2014 - 14:56:49)"
14880	0x3A20	CRC32 polynomial table, big endian
16176	0x3F30	uImage header, header size: 64 bytes, header CRC: 0x3AC66E95, ↵ ↳ created: 2014-06-27 06:56:50, image size: 34587 bytes, Data Address: 0x80010000, Entry ↵ ↳ Point: 0x80010000, data CRC: 0xDF2DBA0B, OS: Linux, CPU: MIPS, image type: Firmware Image ↵ ↳ , compression type: lzma, image name: "u-boot image"
16240	0x3F70	LZMA compressed data, properties: 0x5D, dictionary size: 33554432 ↵ ↳ bytes, uncompressed size: 90000 bytes
131584	0x20200	TP-Link firmware header, firmware version: 0.0.3, image version: ↵ ↳ "", product ID: 0x0, product version: 155254789, kernel load address: 0x0, kernel entry ↵ ↳ point: 0x-7FFFE000, kernel offset: 3932160, kernel length: 512, rootfs offset: 837431, ↵ ↳ rootfs length: 1048576, bootloader offset: 2883584, bootloader length: 0
132096	0x20400	LZMA compressed data, properties: 0x5D, dictionary size: 33554432 ↵ ↳ bytes, uncompressed size: 2388212 bytes
1180160	0x120200	Squashfs filesystem, little endian, version 4.0, compression:lzma ↵ ↳ , size: 2548511 bytes, 536 inodes, blocksize: 131072 bytes, created: 2014-06-27 07:06:52

Indeed: there are some stuff at the beginning, but two large LZMA compressed blocks are started at 0x20400 and 0x120200. These are roughly addresses we have seen in Mathematica. Oh, and by the way, binwalk can show entropy information as well (-E option):

DECIMAL	HEXADECIMAL	ENTROPY
0	0x0	Falling entropy edge (0.419187)

16384	0x4000	Rising entropy edge (0.988639)
51200	0xC800	Falling entropy edge (0.000000)
133120	0x20800	Rising entropy edge (0.987596)
968704	0xEC800	Falling entropy edge (0.508720)
1181696	0x120800	Rising entropy edge (0.989615)
3727360	0x38E000	Falling entropy edge (0.732390)

Rising edges are corresponding to rising edges of block on our graph. Falling edges are the points where empty lacunas are started.

Binwalk can also generate PNG graphs (-E -J):

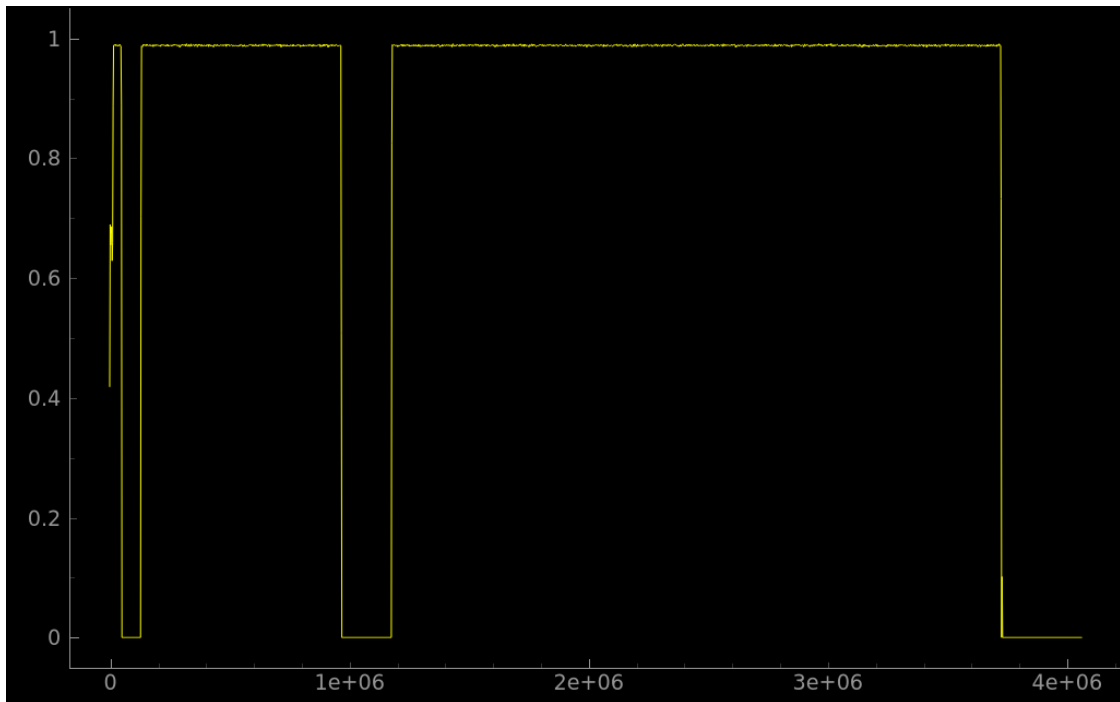

What can we say about lacunas? By looking in hex editor, we see that these are just filled with 0xFF bytes. Why developers put them? Perhaps, because they weren't able to calculate precise compressed blocks sizes, so they allocated space for them with some reserve.

### Notepad

Another example is notepad.exe I've picked in Windows 8.1:

```
In[72]:= (* that will be the main knob here *)
{Slider[Dynamic[offset], {0, Length[input] - BlockSize, BlockSize}],
```

```
Out[72]:= {  , 1900016 }
```

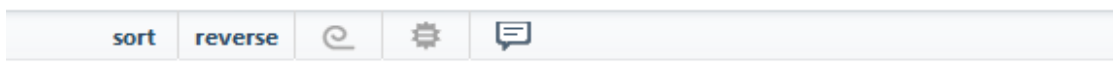

```
In[59]:= (* main UI part *)
```

```
Dynamic[{ListLinePlot[entropies, GridLines -> {{-1, offset/BlockSize},
CurrentBlock = fBlockToShow[input, offset];
fPutHexWindow[CurrentBlock], fPutASCIIWindow[CurrentBlock]]}
```

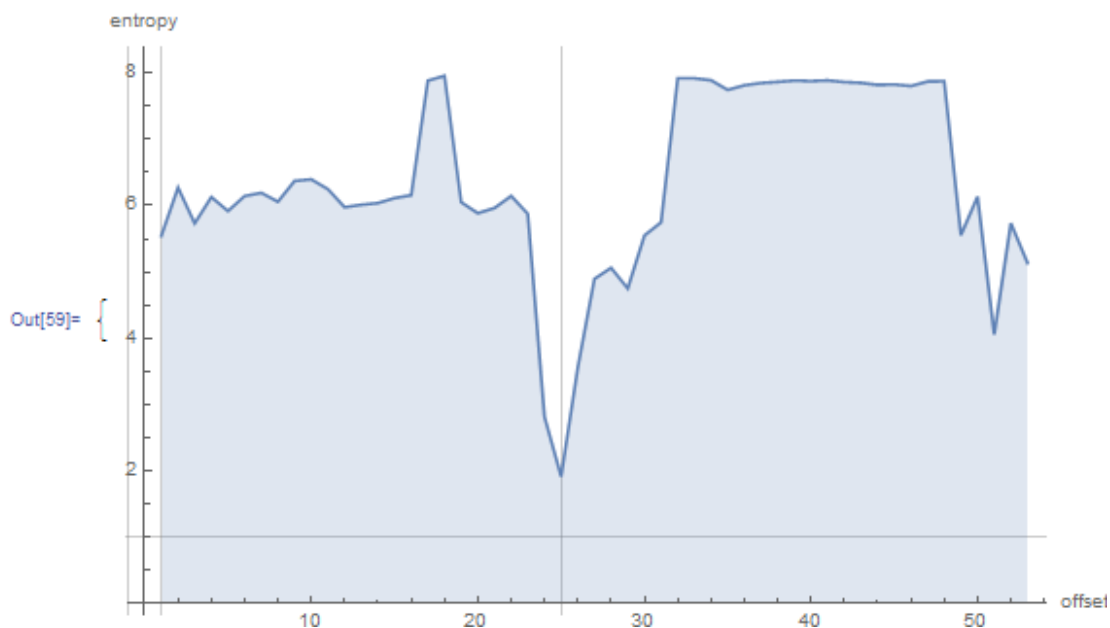

60	7f	1	0	d0	69	0	0	24	6a	0	0	8c	7f	1	0
24	6a	0	0	e0	6a	0	0	94	7f	1	0	e0	6a	0	0
a5	6b	0	0	14	7d	1	0	c0	6b	0	0	c	6c	0	0
c	7d	1	0	c	6c	0	0	5b	6c	0	0	9c	7f	1	0
5b	6c	0	0	a4	6c	0	0	15	c1	1	0	a4	6c	0	0
5f	6d	0	0	bc	7f	1	0	5f	6d	0	0	c0	6d	0	0
9d	c0	1	0	c0	6d	0	0	14	6e	0	0	28	7f	1	0
80	78	0	0	9e	78	0	0	bd	c1	1	0	9e	78	0	0
c4	78	0	0	f1	c0	1	0	c4	78	0	0	19	79	0	0
ed	c1	1	0	19	79	0	0	d7	81	0	0	31	c0	1	0
d7	81	0	0	d1	83	0	0	3d	c0	1	0	d1	83	0	0
b2	86	0	0	d	c0	1	0	b2	86	0	0	1f	87	0	0
69	c1	1	0	1f	87	0	0	3d	87	0	0	9	c1	1	0
3d	87	0	0	5a	87	0	0	15	c1	1	0	5a	87	0	0
83	87	0	0	85	c0	1	0	83	87	0	0	25	8a	0	0
61	c0	1	0	25	8a	0	0	36	8a	0	0	d5	c1	1	0

`	□	□	□	□	i	□	□	\$	j	□	□	□	□	□	□
\$	j	□	□	□	j	□	□	□	□	□	□	□	□	j	□
□	k	□	□	□	}	□	□	□	k	□	□	□	□	□	□
□	}	□	□	□	l	□	□	[	l	□	□	□	□	□	□
[	l	□	□	□	l	□	□	□	□	□	□	□	□	□	□
_	m	□	□	□	□	□	□	_	m	□	□	□	□	m	□
□	□	□	□	□	m	□	□	□	n	□	□	(	□	□	□
□	x	□	□	□	x	□	□	□	□	□	□	□	□	x	□
□	x	□	□	□	□	□	□	□	x	□	□	□	□	y	□
□	□	□	□	□	y	□	□	□	□	□	□	□	□	□	□
□	□	□	□	□	□	□	□	=	□	□	□	□	□	□	□
□	□	□	□	□	□	□	□	□	□	□	□	□	□	□	□
i	□	□	□	□	□	□	□	=	□	□	□	□	□	□	□
=	□	□	□	□	□	□	□	□	□	□	□	□	□	□	□
□	□	□	□	□	□	□	□	□	□	□	□	□	□	□	□
□	□	□	□	□	□	□	□	□	□	□	□	□	□	□	□
a	□	□	□	□	□	□	□	□	6	□	□	□	□	□	□

There is cavity at  $\approx 0x19000$  (absolute file offset). I've opened the executable file in hex editor and found imports table there (which has lower entropy than x86-64 code in the first half of graph).

There are also high entropy block started at  $\approx 0x20000$ :

```
In[72]:= (* that will be the main knob here *)
{Slider[Dynamic[offset], {0, Length[input] - BlockSize, BlockSize}]}
```

```
Out[72]:= {  , 2000016 }
```

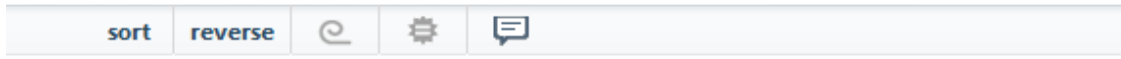

```
In[59]:= (* main UI part *)
Dynamic[{ListLinePlot[entropies, GridLines -> {{-1, offset/BlockSiz
CurrentBlock = fBlockToShow[input, offset];
fPutHexWindow[CurrentBlock], fPutASCIIWindow[CurrentBlock]}]}
```

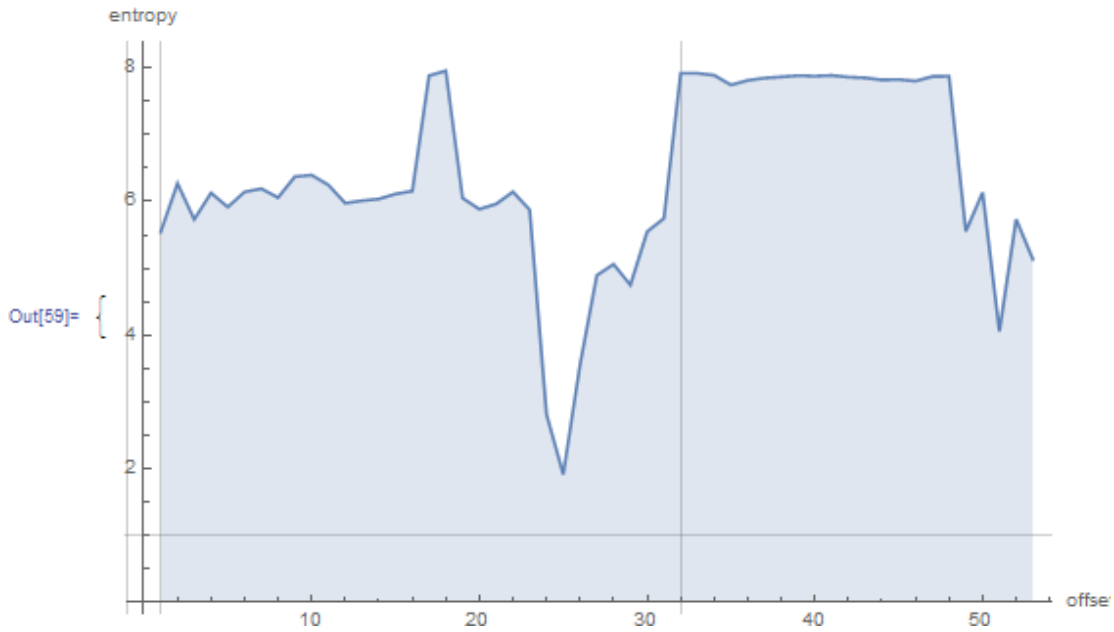

```
f5 d3 2 2 4f 6e 6 31 3a b9 86 33 4f 77 7e 3e
f4 b5 f fa df 4d b9 7d cd 8d 37 ad ff f3 25 97
9e ee f5 da eb 7 52 f2 b d7 1a ef cf de 83 5
19 d1 a3 1f 6b dd ba f0 ba 9b 6f 55 24 f1 c6 e8
e1 d3 f0 7e b6 da 4d 52 a8 6e ec 84 b7 df 4b 8f
7f cf a3 4f 1c 1e fe c1 98 41 8 25 9e cc af 5c
b8 6d 2b de 3f ff 91 24 90 50 6d 64 75 a3 d7 9b
6f 55 62 70 2a f0 ad 89 13 e2 31 3f b1 e 5e ff
73 53 da e4 ef c0 61 2c f4 3c 34 32 7c e0 9c 5
13 93 fd 87 8e 3a 30 76 da 7 1f b2 aa 82 f2 e6
17 f6 d4 26 88 e2 93 77 a7 cd 39 c1 d0 84 a3 dd
61 e9 f3 bb 38 79 5 86 c 2d 24 f0 6d c1 f4 43
7c 1e c0 3f a8 5b c6 c2 cc af bf f9 e6 ab 2f a1
0 48 0 34 34 3 c8 e7 b8 6 c6 26 49 41 c5 22
99 36 37 40 c6 4f 7a 1f b1 ff 66 59 b5 73 9f ec
38 76 4a ca 96 ac 90 51 33 e6 9 fe d8 64 c4 f8
```

```

O n 1 : 3 O w ~ >
M } 7  %
R  o U $
k  o U $
~  M R n  K
O  A % \
m + ? $ P m d u
o U b p * 1 ? ^
s S a , < 4 2 |
: 0 v
&  w 9
a 8 y - $ m C
| ? [  /
H 4 4  & I A "
6 7 @ 0 z  f Y s
8 v J  Q 3  d
```

In hex editor I can see PNG file here, embedded in the PE file resource section (it is a large image of notepad icon). PNG files are compressed, indeed.

### Unnamed dashcam

Now the most advanced example in this part is the firmware of some unnamed dashcam I've received from a friend:



```
In[83]:= (* that will be the main knob here *)
{Slider[Dynamic[offset], {0, Length[input] - BlockSize, BlockSize}],

Out[83]:= { , 3d00016 }
```

```
In[59]:= (* main UI part *)
Dynamic[{ListLinePlot[entropies, GridLines -> {{-1, offset/BlockSize}
CurrentBlock = fBlockToShow[input, offset];
fPutHexWindow[CurrentBlock], fPutASCIIWindow[CurrentBlock]]}
```

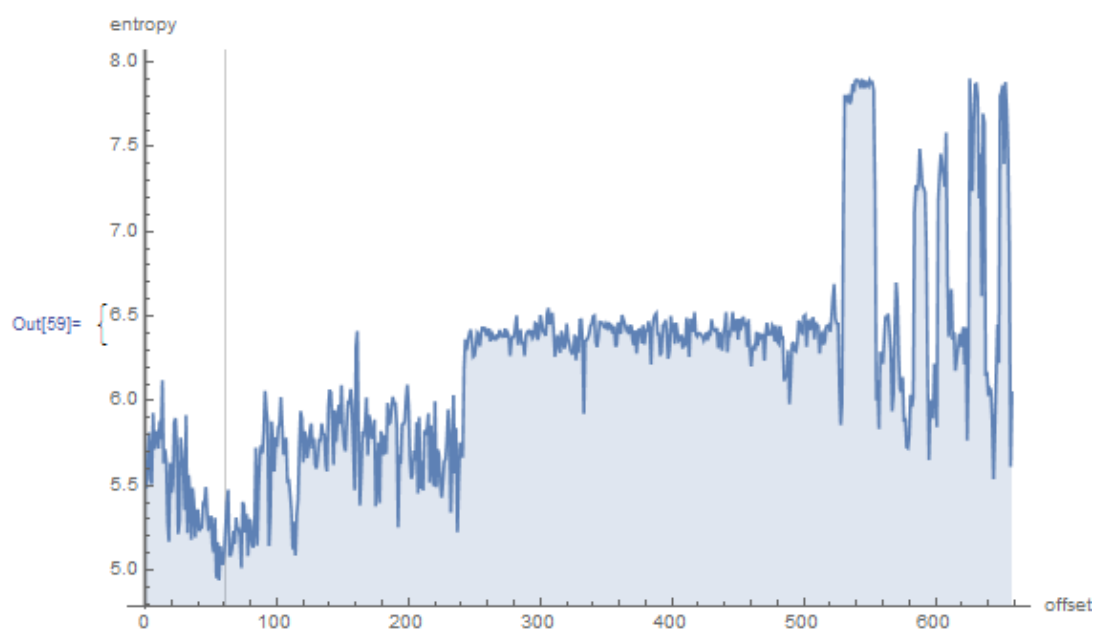

44 5f 53 50 49 5f 46 57 32 0 0 0 53 45 4d 49	D _ S P I _ F W 2 0 0 0 S E M I
44 5f 53 50 49 5f 46 57 33 0 0 0 53 45 4d 49	D _ S P I _ F W 3 0 0 0 S E M I
44 5f 53 50 49 5f 50 53 0 0 0 0 53 45 4d 49	D _ S P I _ P S 0 0 0 0 S E M I
44 5f 53 50 49 5f 50 53 32 0 0 0 53 45 4d 49	D _ S P I _ P S 2 0 0 0 S E M I
44 5f 53 50 49 5f 50 53 33 0 0 0 53 45 4d 49	D _ S P I _ P S 3 0 0 0 S E M I
44 5f 53 50 49 5f 46 41 54 0 0 0 53 45 4d 49	D _ S P I _ F A T 0 0 0 S E M I
44 5f 53 50 49 5f 46 41 54 32 0 0 53 45 4d 49	D _ S P I _ F A T 2 0 0 S E M I
44 5f 53 50 49 5f 46 41 54 33 0 0 5e 52 25 73	D _ S P I _ F A T 3 0 0 ^ R % s
3a 3a 25 73 28 29 3a 25 64 2d 45 52 52 3a 20 25	: : % s ( ) : % d - E R R : % }
73 3a 20 53 65 6e 4d 6f 64 65 28 25 64 29 20 6f	s : S e n M o d e ( % d ) o
75 74 20 6f 66 20 72 61 6e 67 65 21 21 21 d a	u t o f r a n g e ! ! !
0 0 0 0 41 52 30 33 33 30 0 0 5e 52 25 73	0 0 0 A R 0 3 3 0 0 0 ^ R % s
3a 3a 25 73 28 29 3a 25 64 2d 45 52 52 3a 20 45	: : % s ( ) : % d - E R R : E
72 72 6f 72 20 74 72 61 6e 73 6d 69 74 20 64 61	r r o r t r a n s m i t d a
74 61 20 28 77 72 69 74 65 20 61 64 64 72 29 21	t a ( w r i t e a d d r ) !
21 d a 0 5e 52 25 73 3a 3a 25 73 28 29 3a 25	! 0 ^ R % s : : % s ( ) : %

The cavity at the very beginning is an English text: debugging messages. I checked various ISAs and I found that the first third of the whole file (with the text segment inside) is in fact MIPS (little-endian) code.

For instance, this is very distinctive MIPS function epilogue:

```
ROM:000013B0      move    $sp, $fp
ROM:000013B4      lw      $ra, 0x1C($sp)
ROM:000013B8      lw      $fp, 0x18($sp)
ROM:000013BC      lw      $s1, 0x14($sp)
ROM:000013C0      lw      $s0, 0x10($sp)
ROM:000013C4      jr      $ra
ROM:000013C8      addiu   $sp, 0x20
```

From our graph we can see that MIPS code has entropy of 5-6 bits per byte. Indeed, I once measured various ISAs entropy and I've got these values:

- x86: .text section of ntoskrnl.exe file from Windows 2003: 6.6
- x64: .text section of ntoskrnl.exe file from Windows 7 x64: 6.5
- ARM (thumb mode), Angry Birds Classic: 7.05
- ARM (ARM mode) Linux Kernel 3.8.0: 6.03
- MIPS (little endian), .text section of user32.dll from Windows NT 4: 6.09

So the entropy of executable code is higher than of English text, but still can be compressed.

Now the second third is started at 0xF5000. I don't know what this is. I tried different ISAs but without success. The entropy of the block is looks even steadier than for executable one. Maybe some kind of data?

There is also a spike at  $\approx 0x213000$ . I checked it in hex editor and I found JPEG file there (which, of course, compressed)! I also don't know what is at the end. Let's try Binwalk for this file:

```
% binwalk FW96650A.bin
```

DECIMAL	HEXADECIMAL	DESCRIPTION
167698	0x28F12	Unix path: /15/20/24/25/30/60/120/240fps can be served..
280286	0x446DE	Copyright string: "Copyright (c) 2012 Novatek Microelectronic Corp."
2169199	0x21196F	JPEG image data, JFIF standard 1.01
2300847	0x231BAF	MySQL MISAM compressed data file Version 3

```
% binwalk -E FW96650A.bin
```

DECIMAL	HEXADECIMAL	ENTROPY
0	0x0	Falling entropy edge (0.579792)
2170880	0x212000	Rising entropy edge (0.967373)
2267136	0x229800	Falling entropy edge (0.802974)
2426880	0x250800	Falling entropy edge (0.846639)
2490368	0x260000	Falling entropy edge (0.849804)
2560000	0x271000	Rising entropy edge (0.974340)
2574336	0x274800	Rising entropy edge (0.970958)
2588672	0x278000	Falling entropy edge (0.763507)
2592768	0x279000	Rising entropy edge (0.951883)
2596864	0x27A000	Falling entropy edge (0.712814)
2600960	0x27B000	Rising entropy edge (0.968167)
2607104	0x27C800	Rising entropy edge (0.958582)
2609152	0x27D000	Falling entropy edge (0.760989)
2654208	0x288000	Rising entropy edge (0.954127)
2670592	0x28C000	Rising entropy edge (0.967883)
2676736	0x28D800	Rising entropy edge (0.975779)
2684928	0x28F800	Falling entropy edge (0.744369)

Yes, it found JPEG file and even MySQL data! But I'm not sure if it's true—I didn't check it yet.

It's also interesting to try clusterization in Mathematica:

```
In[84]:= (* let also take a look on clustering attempt of Mathematica *)
```

```
ListPlot[FindClusters[entropies]]
```

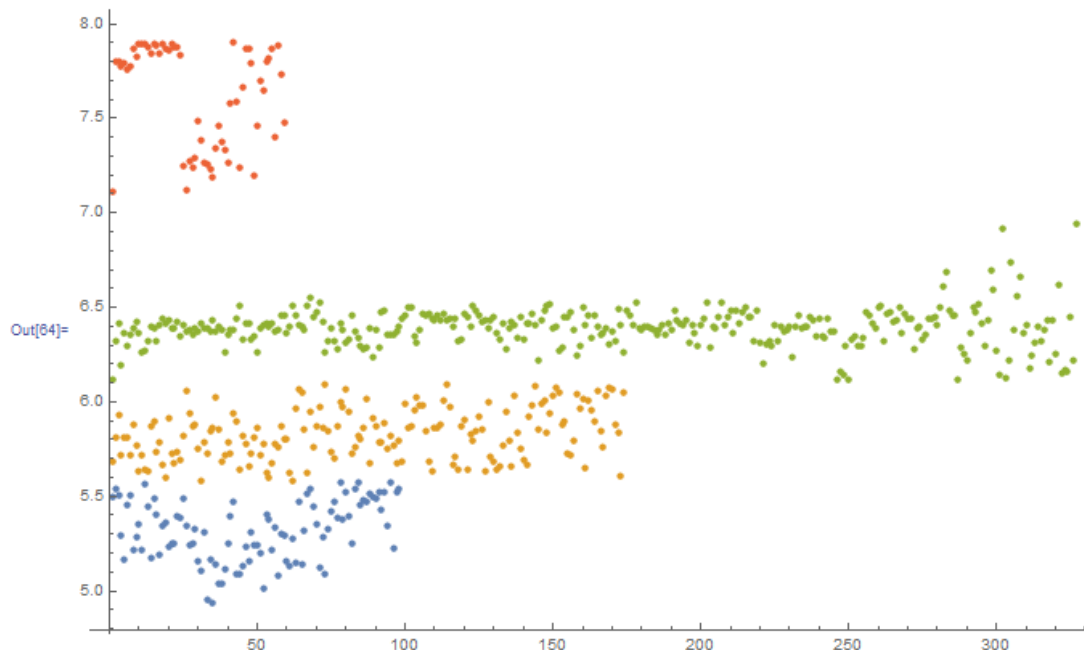

Here is an example of how Mathematica grouped various entropy values into distinctive groups. Indeed, there is something credible. Blue dots in range of 5.0-5.5 are supposedly related to English text. Yellow dots in 5.5-6 are MIPS code. A lot of green dots in 6.0-6.5 is the unknown second third. Orange dots close to 8.0 are related to compressed JPEG file. Other orange dots are supposedly related to the end of the firmware (unknown to us data).

## Links

Binary files used in this part:

<https://beginners.re/current-tree/ff/entropy/files/>.

Wolfram Mathematica notebook file:

[https://beginners.re/current-tree/ff/entropy/files/binary\\_file\\_entropy.nb](https://beginners.re/current-tree/ff/entropy/files/binary_file_entropy.nb)

(all cells must be evaluated to start things working).

## 9.2.2 Conclusion

Information entropy can be used as a quick-n-dirty method for inspecting unknown binary files. In particular, it is a very quick way to find compressed/encrypted pieces of data. Someone say it's possible to find [RSA<sup>5</sup>](#) (and other asymmetric cryptographic algorithms) public/private keys in executable code (keys has high entropy as well), but I didn't try this myself.

## 9.2.3 Tools

Handy Linux *ent* utility to measure entropy of a file<sup>6</sup>.

There is a great online entropy visualizer made by Aldo Cortesi, which I tried to mimic using Mathematica:

<http://binvis.io>. His articles about entropy visualization are worth reading: <http://corte.si/posts/visualisation/entropy/index.html>, <http://corte.si/posts/visualisation/malware/index.html>, <http://corte.si/posts/visualisation/binvis/index.html>.

radare2 framework has *#entropy* command for this.

A tool for IDA: IDAtropy<sup>7</sup>.

---

<sup>5</sup>Rivest Shamir Adleman

<sup>6</sup><http://www.fourmilab.ch/random/>

<sup>7</sup><https://github.com/danigargu/IDAtropy>

## 9.2.4 A word about primitive encryption like XORing

It's interesting that simple XOR encryption doesn't affect entropy of data. I've shown this in *Norton Guide* example in the book ( [9.1.2 on page 924](#)).

Generalizing: encryption by substitution cipher also doesn't affect entropy of data (and XOR can be viewed as substitution cipher). The reason of that is because entropy calculation algorithm view data on byte-level. On the other hand, the data encrypted by 2 or 4-byte XOR pattern will result in another level of entropy.

Nevertheless, low entropy is usually a good sign of weak amateur cryptography (which is also used in license keys/files, etc.).

## 9.2.5 More about entropy of executable code

It is quickly noticeable that probably a biggest source of high-entropy in executable code are relative offsets encoded in opcodes. For example, these two consequent instructions will have different relative offsets in their opcodes, while they are in fact pointing to the same function:

```
function proc
...
function endp

...

CALL function
...
CALL function
```

Ideal executable code compressor would encode information like this: *there is a CALL to a "function" at address X and the same CALL at address Y* without necessity to encode address of the *function* twice.

To deal with this, executable compressors are sometimes able to reduce entropy here. One example is UPX: <http://sourceforge.net/p/upx/code/ci/default/tree/doc/filter.txt>.

## 9.2.6 PRNG

When I run GnuPG to generate new private (secret) key, it asking for some entropy ...

```
We need to generate a lot of random bytes. It is a good idea to perform
some other action (type on the keyboard, move the mouse, utilize the
disks) during the prime generation; this gives the random number
generator a better chance to gain enough entropy.
```

```
Not enough random bytes available. Please do some other work to give
the OS a chance to collect more entropy! (Need 169 more bytes)
```

This means that good a [PRNG](#) produces long high-entropy results, and this is what the secret asymmetrical cryptographical key needs. But [CPRNG](#)<sup>8</sup> is tricky (because computer is highly deterministic device itself), so the GnuPG asking for some additional randomness from the user.

## 9.2.7 More examples

Here is a case where I try to calculate entropy of some blocks with unknown contents: [8.9 on page 851](#).

## 9.2.8 Entropy of various files

Entropy of random data is close to 8:

```
% dd bs=1M count=1 if=/dev/urandom | ent
Entropy = 7.999803 bits per byte.
```

<sup>8</sup>Cryptographically secure PseudoRandom Number Generator

This means, almost all available space inside of byte is filled with information.

256 bytes in range of 0..255 gives exact value of 8:

```
#!/usr/bin/env python
import sys

for i in range(256):
    sys.stdout.write(chr(i))
```

```
% python 1.py | ent
Entropy = 8.000000 bits per byte.
```

Order of bytes doesn't matter. This means, all available space inside of byte is filled.

Entropy of any block filled with zero bytes is 0:

```
% dd bs=1M count=1 if=/dev/zero | ent
Entropy = 0.000000 bits per byte.
```

Entropy of a string consisting of a single (any) byte is 0:

```
% echo -n "aaaaaaaaaaaaaaaaaaaa" | ent
Entropy = 0.000000 bits per byte.
```

Entropy of base64 string is the same as entropy of source data, but multiplied by  $\frac{3}{4}$ . This is because base64 encoding uses 64 symbols instead of 256.

```
% dd bs=1M count=1 if=/dev/urandom | base64 | ent
Entropy = 6.022068 bits per byte.
```

Perhaps, 6.02 is slightly bigger than 6 because padding symbols (=) spoils our statistics for a little.

Uuencode also uses 64 symbols:

```
% dd bs=1M count=1 if=/dev/urandom | uuencode - | ent
Entropy = 6.013162 bits per byte.
```

This means, any base64 and Uuencode strings can be transmitted using 6-bit bytes or characters.

Any random information in hexadecimal form has entropy of 4 bits per byte:

```
% openssl rand -hex $$$(( 2**16 )) | ent
Entropy = 4.000013 bits per byte.
```

Entropy of randomly picked English language text from Gutenberg library has entropy  $\approx 4.5$ . The reason of this is because English texts uses mostly 26 symbols, and  $\log_2(26) \approx 4.7$ , i.e., you would need 5-bit bytes to transmit uncompressed English texts, that would be enough (it was indeed so in teletype era).

Randomly chosen Russian language text from <http://lib.ru> library is F.M.Dostoevsky "Idiot"<sup>9</sup>, internally encoded in CP1251 encoding.

And this file has entropy of  $\approx 4.98$ . Russian language has 33 characters, and  $\log_2(33) \approx 5.04$ . But it has unpopular and rare "ë" character. And  $\log_2(32) = 5$  (Russian alphabet without this rare character)—now this close to what we've got.

However, the text we studying uses "ë" letter, but, probably, it's still rarely used there.

<sup>9</sup>[http://az.lib.ru/d/dostoewskij\\_f\\_m/text\\_0070.shtml](http://az.lib.ru/d/dostoewskij_f_m/text_0070.shtml)

The very same file transcoded from CP1251 to UTF-8 gave entropy of  $\approx 4.23$ . Each Cyrillic character encoded in UTF-8 is usually encoded as a pair, and the first byte is always one of: 0xD0 or 0xD1. Perhaps, this caused bias.

Let's generate random bits and output them as "T" and "F" characters:

```
#!/usr/bin/env python
import random, sys

rt=""
for i in range(102400):
    if random.randint(0,1)==1:
        rt=rt+"T"
    else:
        rt=rt+"F"
print rt
```

Sample: ...TTTFTFTTTFFFTTTFTTTTTFTTFFTTTFTTTFTTTFFFFF....

Entropy is very close to 1 (i.e., 1 bit per byte).

Let's generate random decimal digits:

```
#!/usr/bin/env python
import random, sys

rt=""
for i in range(102400):
    rt=rt+"%d" % random.randint(0,9)
print rt
```

Sample: ...52203466119390328807552582367031963888032....

Entropy will be close to 3.32, indeed, this is  $\log_2(10)$ .

### 9.2.9 Making lower level of entropy

The author of these lines once saw a software which stored each byte of encrypted data in 3 bytes: each has  $\approx \frac{\textit{byte}}{3}$  value, so reconstructing encrypted byte back involving summing up 3 consecutive bytes. Looks absurdly.

But some people say this was done in order to conceal the very fact the data has something encrypted inside: measuring entropy of such block will show much lower level of it.

## 9.3 Millenium game save file

The "Millenium Return to Earth" is an ancient DOS game (1991), that allows you to mine resources, build ships, equip them and send them on other planets, and so on<sup>10</sup>.

Like many other games, it allows you to save all game state into a file.

Let's see if we can find something in it.

---

<sup>10</sup>It can be downloaded for free [here](#)

So there is a mine in the game. Mines at some planets work faster, or slower on others. The set of resources is also different.

Here we can see what resources are mined at the time:



Figure 9.14: Mine: state 1

Let's save a game state. This is a file of size 9538 bytes.

Let's wait some "days" here in the game, and now we've got more resources from the mine:

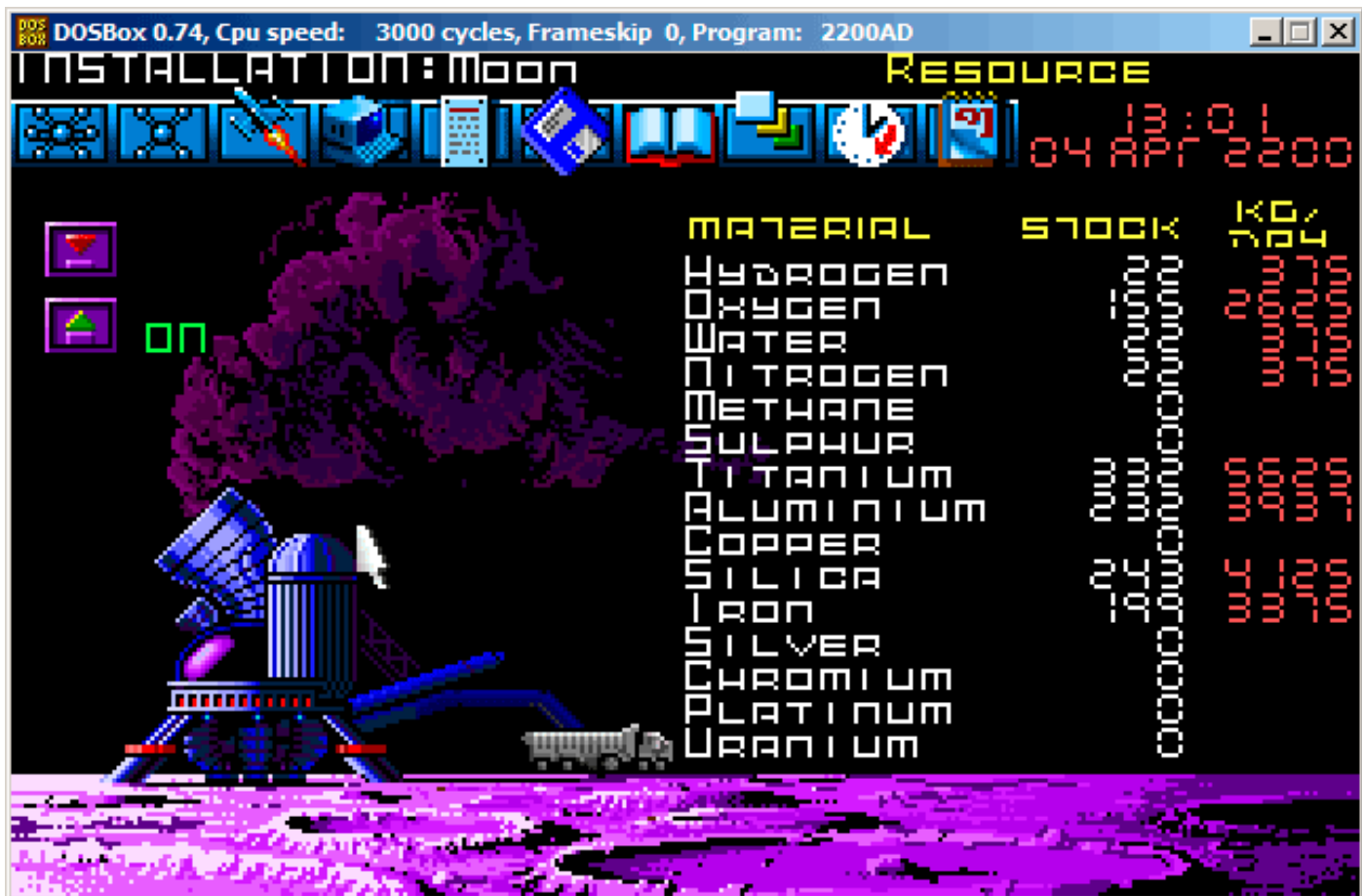

Figure 9.15: Mine: state 2

Let's save game state again.

Now let's try to just do binary comparison of the save files using the simple DOS/Windows FC utility:

```

...> FC /b 2200save.i.v1 2200SAVE.I.V2

Comparing files 2200save.i.v1 and 2200SAVE.I.V2
00000016: 0D 04
00000017: 03 04
0000001C: 1F 1E
00000146: 27 3B
00000BDA: 0E 16
00000BDC: 66 9B
00000BDE: 0E 16
00000BE0: 0E 16
00000BE6: DB 4C
00000BE7: 00 01
00000BE8: 99 E8
00000BEC: A1 F3
00000BEE: 83 C7
00000BFB: A8 28
00000BFD: 98 18
00000BFF: A8 28
00000C01: A8 28
00000C07: D8 58
00000C09: E4 A4
00000C0D: 38 B8
00000C0F: E8 68
...

```

The output is incomplete here, there are more differences, but we will cut result to show the most interesting.

In the first state, we have 14 "units" of hydrogen and 102 "units" of oxygen.



We have 22 and 155 “units” respectively in the second state. If these values are saved into the save file, we would see this in the difference. And indeed we do. There is 0x0E (14) at position 0xBDA and this value is 0x16 (22) in the new version of the file. This is probably hydrogen. There is 0x66 (102) at position 0xBDC in the old version and 0x9B (155) in the new version of the file. This seems to be the oxygen.

Both files are available on the website for those who wants to inspect them (or experiment) more: [beginners.re](#).

Here is the new version of file opened in Hiew, we marked the values related to the resources mined in the game:

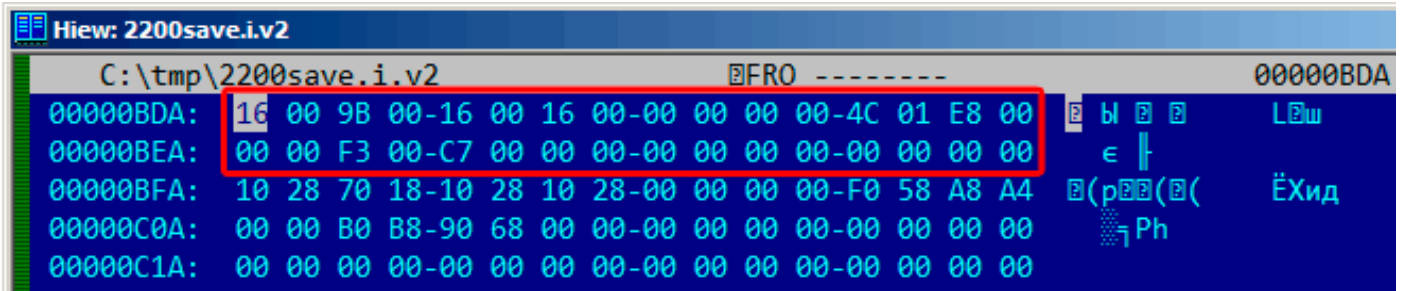

Figure 9.16: Hiew: state 1

Let's check each of them.

These are clearly 16-bit values: not a strange thing for 16-bit DOS software where the *int* type has 16-bit width.

Let's check our assumptions. We will write the 1234 (0x4D2) value at the first position (this must be hydrogen):

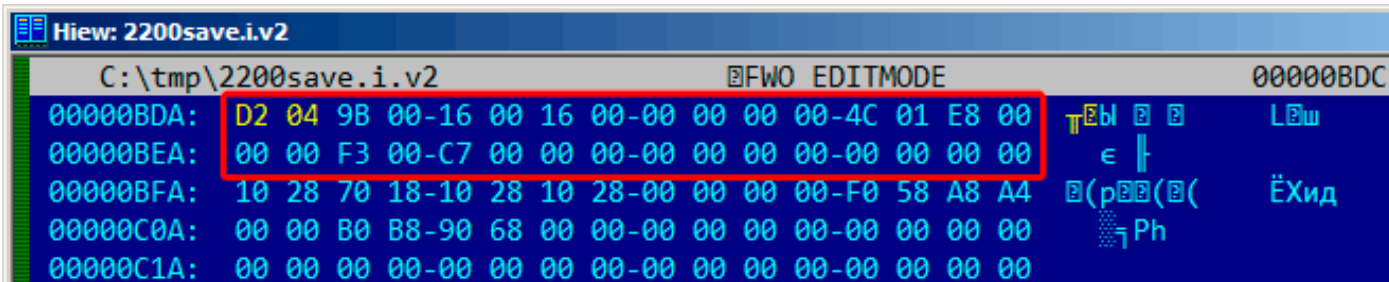

Figure 9.17: Hiew: let's write 1234 (0x4D2) there

Then we will load the changed file in the game and took a look at mine statistics:

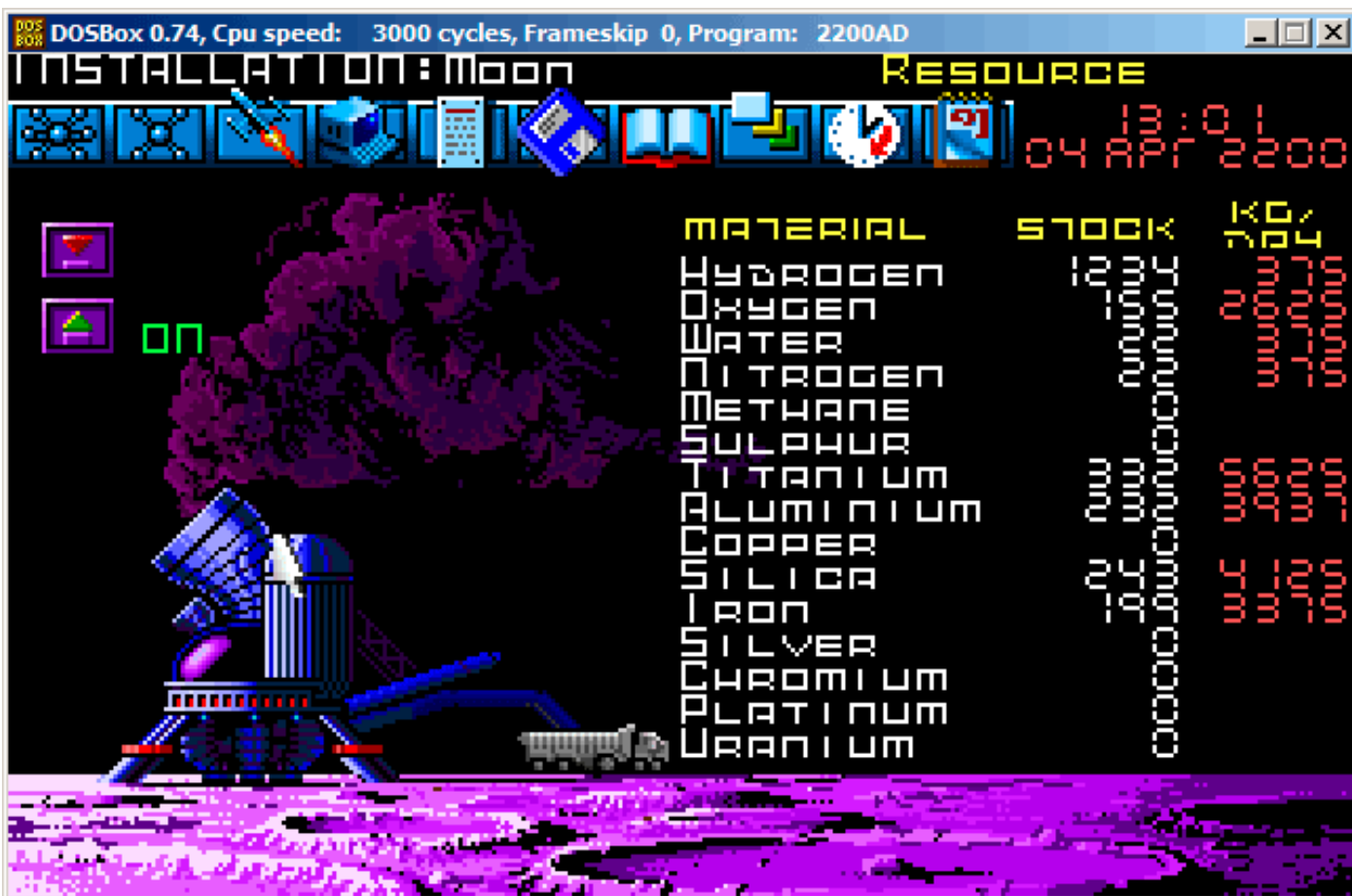

Figure 9.18: Let's check for hydrogen value

So yes, this is it.



Let's skip some "days" in the game and oops! We have a lower amount of some resources:



Figure 9.21: Resource variables overflow

That's just overflow.

The game's developer supposedly didn't think about such high amounts of resources, so there are probably no overflow checks, but the mine is "working" in the game, resources are added, hence the overflows. Apparently, it is a bad idea to be that greedy.

There are probably a lot of more values saved in this file.

So this is very simple method of cheating in games. High score files often can be easily patched like that. More about files and memory snapshots comparing: [5.10.2 on page 727](#).

## 9.4 fortune program indexing file

(This part was first appeared in my blog at 25-Apr-2015.)

*fortune* is well-known UNIX program which shows random phrase from a collection. Some geeks are often set up their system in such way, so *fortune* can be called after logging on. *fortune* takes phrases from the text files laying in */usr/share/games/fortunes* (as of Ubuntu Linux). Here is example ("fortunes" text file):

```
A day for firm decisions!!!! Or is it?
%
A few hours grace before the madness begins again.
%
A gift of a flower will soon be made to you.
%
A long-forgotten loved one will appear soon.

Buy the negatives at any price.
%
```

```
A tall, dark stranger will have more fun than you.
```

```
%  
...
```

So it is just phrases, sometimes multiline ones, divided by percent sign. The task of *fortune* program is to find random phrase and to print it. In order to achieve this, it must scan the whole text file, count phrases, choose random and print it. But the text file can get bigger, and even on modern computers, this naive algorithm is a bit uneconomical to computer resources. The straightforward way is to keep binary index file containing offset of each phrase in text file. With index file, *fortune* program can work much faster: just to choose random index element, take offset from there, set offset in text file and read phrase from it. This is actually done in *fortune* program. Let's inspect what is in its index file inside (these are .dat files in the same directory) in hexadecimal editor. This program is open-source of course, but intentionally, I will not peek into its source code.

```
% od -t x1 --address-radix=x fortunes.dat  
000000 00 00 00 02 00 00 01 af 00 00 00 bb 00 00 00 0f  
000010 00 00 00 00 25 00 00 00 00 00 00 00 00 00 2b  
000020 00 00 00 60 00 00 00 8f 00 00 00 df 00 00 01 14  
000030 00 00 01 48 00 00 01 7c 00 00 01 ab 00 00 01 e6  
000040 00 00 02 20 00 00 02 3b 00 00 02 7a 00 00 02 c5  
000050 00 00 03 04 00 00 03 3d 00 00 03 68 00 00 03 a7  
000060 00 00 03 e1 00 00 04 19 00 00 04 2d 00 00 04 7f  
000070 00 00 04 ad 00 00 04 d5 00 00 05 05 00 00 05 3b  
000080 00 00 05 64 00 00 05 82 00 00 05 ad 00 00 05 ce  
000090 00 00 05 f7 00 00 06 1c 00 00 06 61 00 00 06 7a  
0000a0 00 00 06 d1 00 00 07 0a 00 00 07 53 00 00 07 9a  
0000b0 00 00 07 f8 00 00 08 27 00 00 08 59 00 00 08 8b  
0000c0 00 00 08 a0 00 00 08 c4 00 00 08 e1 00 00 08 f9  
0000d0 00 00 09 27 00 00 09 43 00 00 09 79 00 00 09 a3  
0000e0 00 00 09 e3 00 00 0a 15 00 00 0a 4d 00 00 0a 5e  
0000f0 00 00 0a 8a 00 00 0a a6 00 00 0a bf 00 00 0a ef  
000100 00 00 0b 18 00 00 0b 43 00 00 0b 61 00 00 0b 8e  
000110 00 00 0b cf 00 00 0b fa 00 00 0c 3b 00 00 0c 66  
000120 00 00 0c 85 00 00 0c b9 00 00 0c d2 00 00 0d 02  
000130 00 00 0d 3b 00 00 0d 67 00 00 0d ac 00 00 0d e0  
000140 00 00 0e 1e 00 00 0e 67 00 00 0e a5 00 00 0e da  
000150 00 00 0e ff 00 00 0f 43 00 00 0f 8a 00 00 0f bc  
000160 00 00 0f e5 00 00 10 1e 00 00 10 63 00 00 10 9d  
000170 00 00 10 e3 00 00 11 10 00 00 11 46 00 00 11 6c  
000180 00 00 11 99 00 00 11 cb 00 00 11 f5 00 00 12 32  
000190 00 00 12 61 00 00 12 8c 00 00 12 ca 00 00 13 87  
0001a0 00 00 13 c4 00 00 13 fc 00 00 14 1a 00 00 14 6f  
0001b0 00 00 14 ae 00 00 14 de 00 00 15 1b 00 00 15 55  
0001c0 00 00 15 a6 00 00 15 d8 00 00 16 0f 00 00 16 4e  
...
```

Without any special aid we could see that there are four 4-byte elements on each 16-byte line. Perhaps, it's our index array. I'm trying to load the whole file in Wolfram Mathematica as 32-bit integer array:

```
In[]:= BinaryReadList["c:/tmp1/fortunes.dat", "UnsignedInteger32"]  
  
Out[]= {33554432, 2936078336, 3137339392, 251658240, 0, 37, 0, \  
721420288, 1610612736, 2399141888, 3741319168, 335609856, 1208025088, \  
2080440320, 2868969472, 3858825216, 537001984, 989986816, 2046951424, \  
3305242624, 67305472, 1023606784, 1745027072, 2801991680, 3775070208, \  
419692544, 755236864, 2130968576, 2902720512, 3573809152, 84213760, \  
990183424, 1678049280, 2181365760, 2902786048, 3456434176, \  
4144300032, 470155264, 1627783168, 2047213568, 3506831360, 168230912, \  
1392967680, 2584150016, 4161208320, 654835712, 1493696512, \  
2332557312, 2684878848, 3288858624, 3775397888, 4178051072, \  
...
```

Nope, something wrong. Numbers are suspiciously big. But let's back to *od* output: each 4-byte element has two zero bytes and two non-zero bytes, so the offsets (at least at the beginning of the file) are 16-bit at maximum. Probably different endianness is used in the file? Default endianness in Mathematica is little-endian, as used in Intel CPUs. Now I'm changing it to big-endian:

```
In[]:= BinaryReadList["c:/tmp1/fortunes.dat", "UnsignedInteger32",  
ByteOrdering -> 1]
```

```
Out[]= {2, 431, 187, 15, 0, 620756992, 0, 43, 96, 143, 223, 276, \  
328, 380, 427, 486, 544, 571, 634, 709, 772, 829, 872, 935, 993, \  
1049, 1069, 1151, 1197, 1237, 1285, 1339, 1380, 1410, 1453, 1486, \  
1527, 1564, 1633, 1658, 1745, 1802, 1875, 1946, 2040, 2087, 2137, \  
2187, 2208, 2244, 2273, 2297, 2343, 2371, 2425, 2467, 2531, 2581, \  
2637, 2654, 2698, 2726, 2751, 2799, 2840, 2883, 2913, 2958, 3023, \  
3066, 3131, 3174, 3205, 3257, 3282, 3330, 3387, 3431, 3500, 3552, \  
...
```

Yes, this is something readable. I choose random element (3066) which is 0xBFA in hexadecimal form. I'm opening 'fortunes' text file in hex editor, I'm setting 0xBFA as offset and I see this phrase:

```
% od -t x1 -c --skip-bytes=0xbfa --address-radix=x fortunes  
000bfa 44 6f 20 77 68 61 74 20 63 6f 6d 65 73 20 6e 61  
        D o w h a t c o m e s n a  
000c0a 74 75 72 61 6c 6c 79 2e 20 20 53 65 65 74 68 65  
        t u r a l l y . S e e t h e  
000c1a 20 61 6e 64 20 66 75 6d 65 20 61 6e 64 20 74 68  
        a n d f u m e a n d t h  
.....
```

Or:

```
Do what comes naturally. Seethe and fume and throw a tantrum.  
%
```

Other offset are also can be checked, yes, they are valid offsets.

I can also check in Mathematica that each subsequent element is bigger than previous. I.e., elements of array are ascending. In mathematics lingo, this is called *strictly increasing monotonic function*.

```
In[]:= Differences[input]
```

```
Out[]= {429, -244, -172, -15, 620756992, -620756992, 43, 53, 47, \  
80, 53, 52, 52, 47, 59, 58, 27, 63, 75, 63, 57, 43, 63, 58, 56, 20, \  
82, 46, 40, 48, 54, 41, 30, 43, 33, 41, 37, 69, 25, 87, 57, 73, 71, \  
94, 47, 50, 50, 21, 36, 29, 24, 46, 28, 54, 42, 64, 50, 56, 17, 44, \  
28, 25, 48, 41, 43, 30, 45, 65, 43, 65, 43, 31, 52, 25, 48, 57, 44, \  
69, 52, 62, 73, 62, 53, 37, 68, 71, 50, 41, 57, 69, 58, 70, 45, 54, \  
38, 45, 50, 42, 61, 47, 43, 62, 189, 61, 56, 30, 85, 63, 48, 61, 58, \  
81, 50, 55, 63, 83, 80, 49, 42, 94, 54, 67, 81, 52, 57, 68, 43, 28, \  
120, 64, 53, 81, 33, 82, 88, 29, 61, 32, 75, 63, 70, 47, 101, 60, 79, \  
33, 48, 65, 35, 59, 47, 55, 22, 43, 35, 102, 53, 80, 65, 45, 31, 29, \  
69, 32, 25, 38, 34, 35, 49, 59, 39, 41, 18, 43, 41, 83, 37, 31, 34, \  
59, 72, 72, 81, 77, 53, 53, 50, 51, 45, 53, 39, 70, 54, 103, 33, 70, \  
51, 95, 67, 54, 55, 65, 61, 54, 54, 53, 45, 100, 63, 48, 65, 71, 23, \  
28, 43, 51, 61, 101, 65, 39, 78, 66, 43, 36, 56, 40, 67, 92, 65, 61, \  
31, 45, 52, 94, 82, 82, 91, 46, 76, 55, 19, 58, 68, 41, 75, 30, 67, \  
92, 54, 52, 108, 60, 56, 76, 41, 79, 54, 65, 74, 112, 76, 47, 53, 61, \  
66, 53, 28, 41, 81, 75, 69, 89, 63, 60, 18, 18, 50, 79, 92, 37, 63, \  
88, 52, 81, 60, 80, 26, 46, 80, 64, 78, 70, 75, 46, 91, 22, 63, 46, \  
34, 81, 75, 59, 62, 66, 74, 76, 111, 55, 73, 40, 61, 55, 38, 56, 47, \  
78, 81, 62, 37, 41, 60, 68, 40, 33, 54, 34, 41, 36, 49, 44, 68, 51, \  
50, 52, 36, 53, 66, 46, 41, 45, 51, 44, 44, 33, 72, 40, 71, 57, 55, \  
39, 66, 40, 56, 68, 43, 88, 78, 30, 54, 64, 36, 55, 35, 88, 45, 56, \  
76, 61, 66, 29, 76, 53, 96, 36, 46, 54, 28, 51, 82, 53, 60, 77, 21, \  
84, 53, 43, 104, 85, 50, 47, 39, 66, 78, 81, 94, 70, 49, 67, 61, 37, \  
51, 91, 99, 58, 51, 49, 46, 68, 72, 40, 56, 63, 65, 41, 62, 47, 41, \  
43, 30, 43, 67, 78, 80, 101, 61, 73, 70, 41, 82, 69, 45, 65, 38, 41, \  
57, 82, 66}
```

As we can see, except of the very first 6 values (which is probably belongs to index file header), all numbers are in fact length of all text phrases (offset of the next phrase minus offset of the current phrase is in fact length of the current phrase).

It's very important to keep in mind that bit-endiannes can be confused with incorrect array start. Indeed, from *od* output we see that each element started with two zeros. But when shifted by two bytes in either side, we can interpret this array as little-endian:

```
% od -t x1 --address-radix=x --skip-bytes=0x32 fortunes.dat
000032 01 48 00 00 01 7c 00 00 01 ab 00 00 01 e6 00 00
000042 02 20 00 00 02 3b 00 00 02 7a 00 00 02 c5 00 00
000052 03 04 00 00 03 3d 00 00 03 68 00 00 03 a7 00 00
000062 03 e1 00 00 04 19 00 00 04 2d 00 00 04 7f 00 00
000072 04 ad 00 00 04 d5 00 00 05 05 00 00 05 3b 00 00
000082 05 64 00 00 05 82 00 00 05 ad 00 00 05 ce 00 00
000092 05 f7 00 00 06 1c 00 00 06 61 00 00 06 7a 00 00
0000a2 06 d1 00 00 07 0a 00 00 07 53 00 00 07 9a 00 00
0000b2 07 f8 00 00 08 27 00 00 08 59 00 00 08 8b 00 00
0000c2 08 a0 00 00 08 c4 00 00 08 e1 00 00 08 f9 00 00
0000d2 09 27 00 00 09 43 00 00 09 79 00 00 09 a3 00 00
0000e2 09 e3 00 00 0a 15 00 00 0a 4d 00 00 0a 5e 00 00
...
```

If we would interpret this array as little-endian, the first element is 0x4801, second is 0x7C01, etc. High 8-bit part of each of these 16-bit values are seems random to us, and the lowest 8-bit part is seems ascending.

But I'm sure that this is big-endian array, because the very last 32-bit element of the file is big-endian (00 00 5f c4 here):

```
% od -t x1 --address-radix=x fortunes.dat
...
000660 00 00 59 0d 00 00 59 55 00 00 59 7d 00 00 59 b5
000670 00 00 59 f4 00 00 5a 35 00 00 5a 5e 00 00 5a 9c
000680 00 00 5a cb 00 00 5a f4 00 00 5b 1f 00 00 5b 3d
000690 00 00 5b 68 00 00 5b ab 00 00 5b f9 00 00 5c 49
0006a0 00 00 5c ae 00 00 5c eb 00 00 5d 34 00 00 5d 7a
0006b0 00 00 5d a3 00 00 5d f5 00 00 5e 3a 00 00 5e 67
0006c0 00 00 5e a8 00 00 5e ce 00 00 5e f7 00 00 5f 30
0006d0 00 00 5f 82 00 00 5f c4
0006d8
```

Perhaps, *fortune* program developer had big-endian computer or maybe it was ported from something like it.

OK, so the array is big-endian, and, judging by common sense, the very first phrase in the text file must be started at zeroth offset. So zero value should be present in the array somewhere at the very beginning. We've got couple of zero elements at the beginning. But the second is most appealing: 43 is going right after it and 43 is valid offset to valid English phrase in the text file.

The last array element is 0x5FC4, and there are no such byte at this offset in the text file. So the last array element is pointing behind the end of file. It's supposedly done because phrase length is calculated as difference between offset to the current phrase and offset to the next phrase. This can be faster than traversing phrase string for percent character. But this wouldn't work for the last element. So the *dummy* element is also added at the end of array.

So the first 6 32-bit integer values are supposedly some kind of header.

Oh, I forgot to count phrases in text file:

```
% cat fortunes | grep % | wc -l
432
```

The number of phrases can be present in index, but may be not. In case of very simple index files, number of elements can be easily deduced from index file size. Anyway, there are 432 phrases in the text file. And we see something very familiar at the second element (value 431). I've checked other files (*literature.dat* and *riddles.dat* in Ubuntu Linux) and yes, the second 32-bit element is indeed number of phrases minus 1. Why *minus 1*? Perhaps, this is not number of phrases, but rather the number of the last phrase (starting at zero)?



And there are some other elements in the header. In Mathematica, I'm loading each of three available files and I'm taking a look on the header:

```
In[14]:= input = BinaryReadList["c:/tmp1/fortunes.dat", "UnsignedInteger32",  
    ByteOrdering -> 1];  
  
In[18]:= BaseForm[Take[input, {1, 6}], 16]  
Out[18]/BaseForm=  
    {216, 1af16, bb16, f16, 016, 2500000016}  
  
In[19]:= input = BinaryReadList["c:/tmp1/literature.dat", "UnsignedInteger32",  
    ByteOrdering -> 1];  
  
In[20]:= BaseForm[Take[input, {1, 6}], 16]  
Out[20]/BaseForm=  
    {216, 10616, 98316, 1a16, 016, 2500000016}  
  
In[21]:= input = BinaryReadList["c:/tmp1/riddles.dat", "UnsignedInteger32", ByteOrdering -> 1];  
  
In[22]:= BaseForm[Take[input, {1, 6}], 16]  
Out[22]/BaseForm=  
    {216, 8016, 7f216, 2416, 016, 2500000016}
```

I have no idea what other values mean, except the size of index file. Some fields are the same for all files, some are not. From my own experience, there could be:

- file signature;
- file version;
- checksum;
- some flags;
- maybe even text language identifier;
- text file timestamp, so the *fortune* program will regenerate index file if a user modified text file.

For example, Oracle .SYM files ( [9.5 on the next page](#)) which contain symbols table for DLL files, also contain timestamp of corresponding DLL file, so to be sure it is still valid.

On the other hand, text file and index file timestamps can gone out of sync after archiving/unarchiving/installing/deploying/etc.

But there are no timestamp, in my opinion. The most compact way of representing date and time is UNIX time value, which is big 32-bit number. We don't see any of such here. Other ways of representation are even less compact.

So here is algorithm, how *fortune* supposedly works:

- take number of last phrase from the second element;
- generate random number in range of 0..number\_of\_last\_phrase;
- find corresponding element in array of offsets, take also following offset;
- output to *stdout* all characters from the text file starting at the offset until the next offset minus 2 (so to ignore terminating percent sign and character of the following phrase).

### 9.4.1 Hacking

Let's try to check some of our assumptions. I will create this text file under the path and name */usr/share/games/fortunes/fortunes*:

```
Phrase one.  
%  
Phrase two.
```



_kpoal8()+2832	CALLrel	_opifch2()	EB1C8A8 1
_opiodr()+1248	CALLreg	00000000	89 5 EB1CC74
_ttcpip()+1051	CALLreg	00000000	5E 1C EB1F0A0
_opitsk()+1404	CALL???	00000000	5E 1C EB1F0A0 0
			C96C040 5E EB1F0A0 0 EB1ED30
			EB1F1CC 53E52E 0 EB1F1F8
_opiino()+980	CALLrel	_opitsk()	0 0
_opiodr()+1248	CALLreg	00000000	3C 4 EB1FBF4
_opidrv()+1201	CALLrel	_opiodr()	3C 4 EB1FBF4 0
_sou2o()+55	CALLrel	_opidrv()	3C 4 EB1FBF4
_opimai_real()+124	CALLrel	_sou2o()	EB1FC04 3C 4 EB1FBF4
_opimai()+125	CALLrel	_opimai_real()	2 EB1FC2C
_OracleThreadStart@	CALLrel	_opimai()	2 EB1FF6C 7C88A7F4 EB1FC34 0
4()+830			EB1FD04
77E6481C	CALLreg	00000000	E41FF9C 0 0 E41FF9C 0 EB1FFC4
00000000	CALL???	00000000	

But of course, Oracle RDBMS's executables must have some kind of debug information or map files with symbol information included or something like that.

Windows NT Oracle RDBMS has symbol information in files with .SYM extension, but the format is proprietary. (Plain text files are good, but needs additional parsing, hence offer slower access.)

Let's see if we can understand its format.

We will pick the shortest orawtc8.sym file that comes with the orawtc8.dll file in Oracle 8.1.7 <sup>12</sup>.

<sup>12</sup>We can chose an ancient Oracle RDBMS version intentionally due to the smaller size of its modules

Here is the file opened in Hiew:

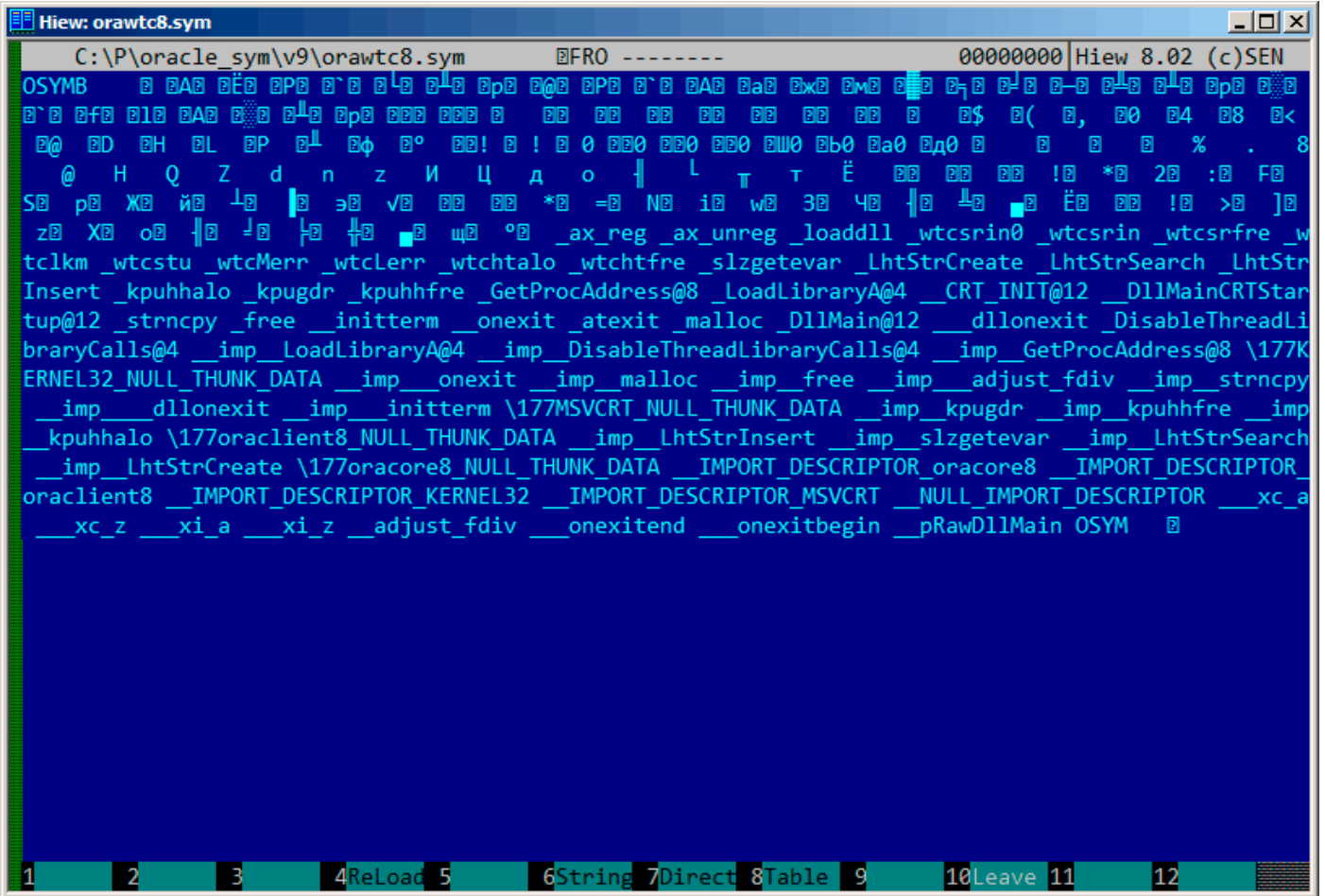

Figure 9.22: The whole file in Hiew

By comparing the file with other .SYM files, we can quickly see that OSYM is always header (and footer), so this is maybe the file's signature.

We also see that basically, the file format is: OSYM + some binary data + zero delimited text strings + OSYM. The strings are, obviously, function and global variable names.

We will mark the OSYM signatures and strings here:

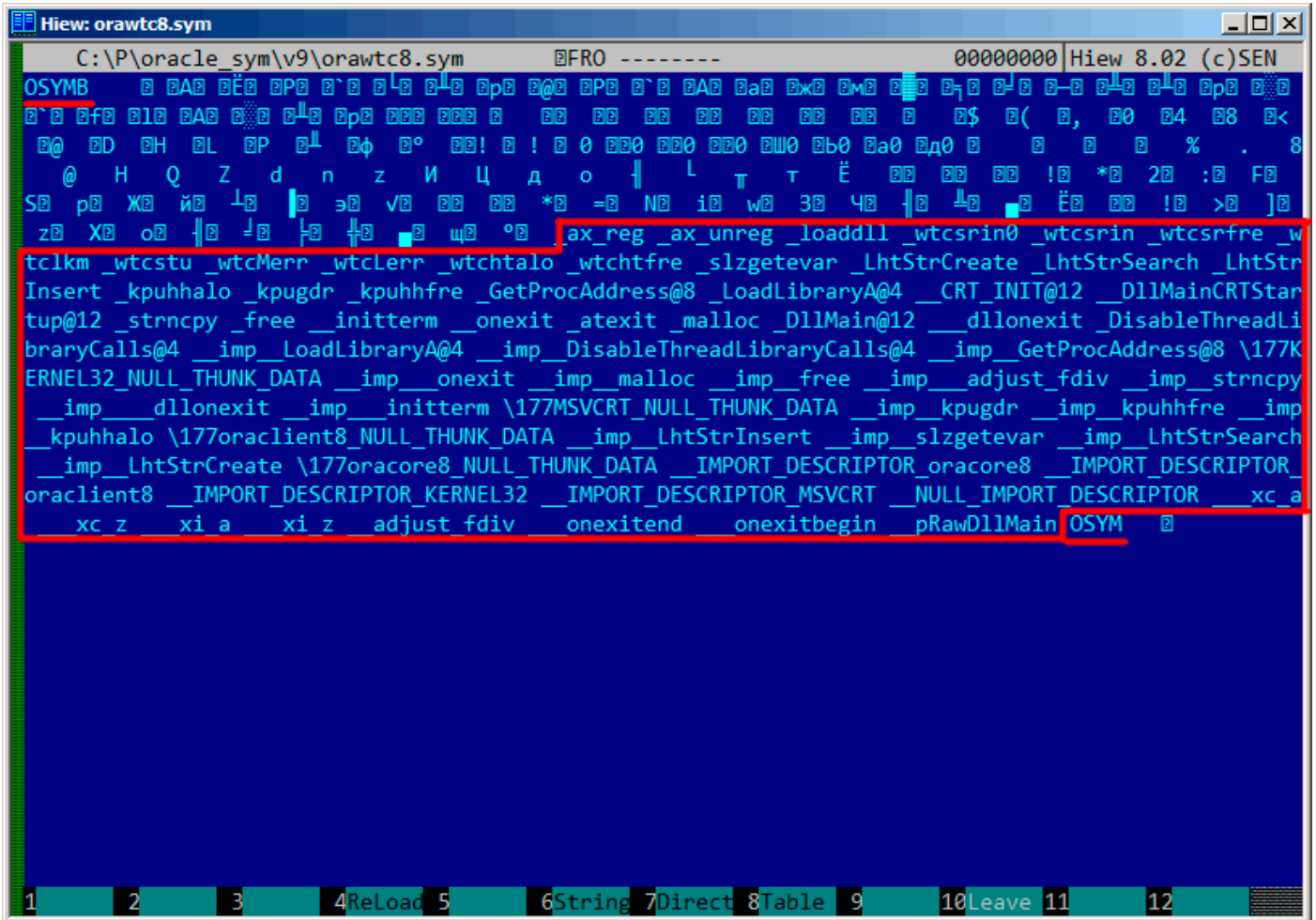

Figure 9.23: OSYM signature and text strings

Well, let's see. In Hiew, we will mark the whole strings block (except the trailing OSYM signatures) and put it into a separate file. Then we run UNIX *strings* and *wc* utilities to count the text strings:

```
strings strings_block | wc -l
66
```

So there are 66 text strings. Please note that number.

We can say, in general, as a rule, the number of *anything* is often stored separately in binary files.

It's indeed so, we can find the 66 value (0x42) at the file's start, right after the OSYM signature:

```
$ hexdump -C orawtc8.sym
00000000 4f 53 59 4d 42 00 00 00 00 10 00 10 80 10 00 10 |OSYMB.....|
00000010 f0 10 00 10 50 11 00 10 60 11 00 10 c0 11 00 10 |....P...`.....|
00000020 d0 11 00 10 70 13 00 10 40 15 00 10 50 15 00 10 |....p...@...P...|
00000030 60 15 00 10 80 15 00 10 a0 15 00 10 a6 15 00 10 |`.....|
....
```

Of course, 0x42 here is not a byte, but most likely a 32-bit value packed as little-endian, hence we see 0x42 and then at least 3 zero bytes.

Why do we believe it's 32-bit? Because, Oracle RDBMS's symbol files may be pretty big.

The oracle.sym file for the main oracle.exe (version 10.2.0.4) executable contains 0x3A38E (238478) symbols. A 16-bit value isn't enough here.

We can check other .SYM files like this and it proves our guess: the value after the 32-bit OSYM signature always reflects the number of text strings in the file.

It's a general feature of almost all binary files: a header with a signature plus some other information about the file.

Now let's investigate closer what this binary block is.

Using Hiew again, we put the block starting at address 8 (i.e., after the 32-bit *count* value) ending at the strings block, into a separate binary file.

Let's see the binary block in Hiew:

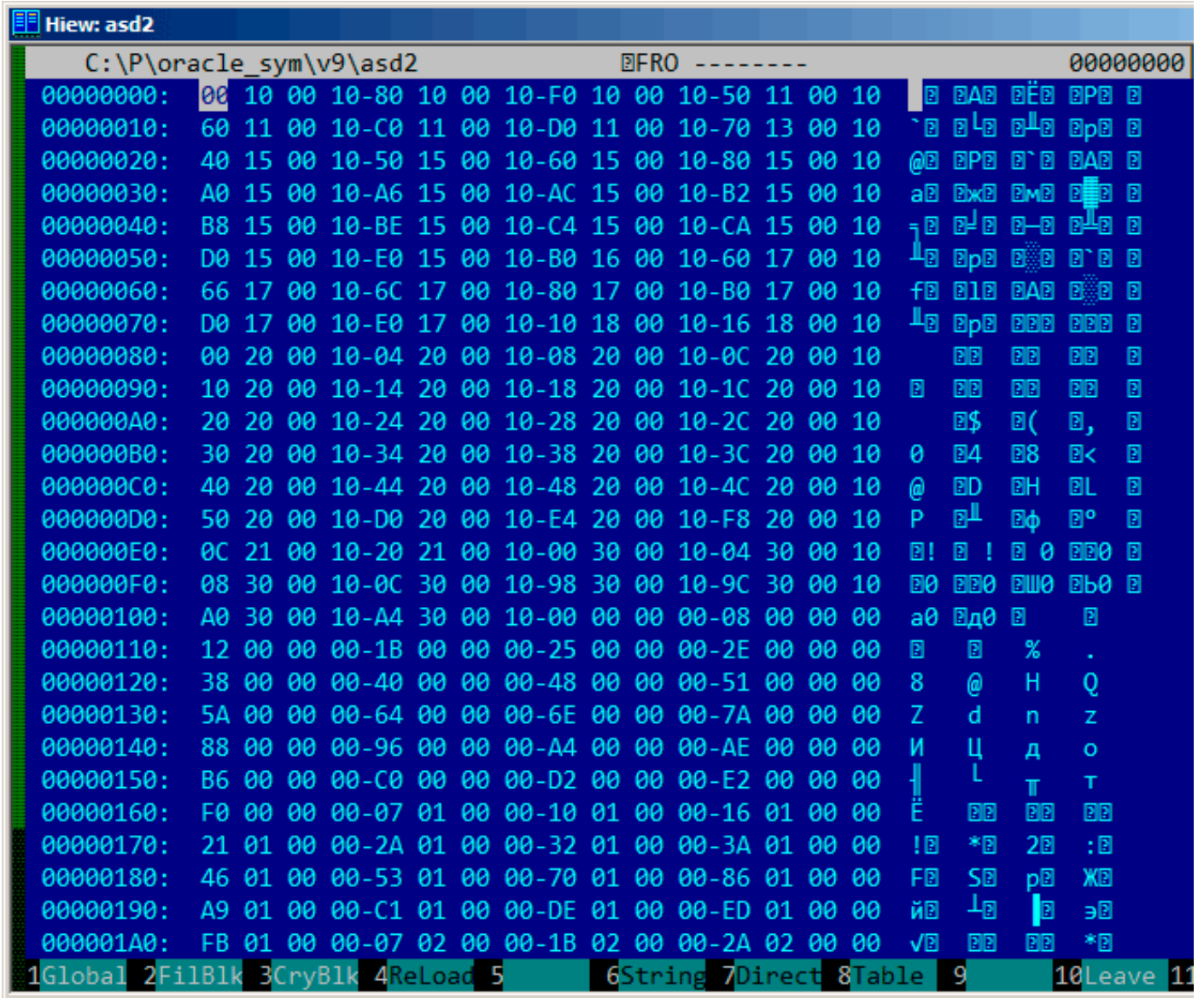

Figure 9.24: Binary block

There is a clear pattern in it.

We will add red lines to divide the block:

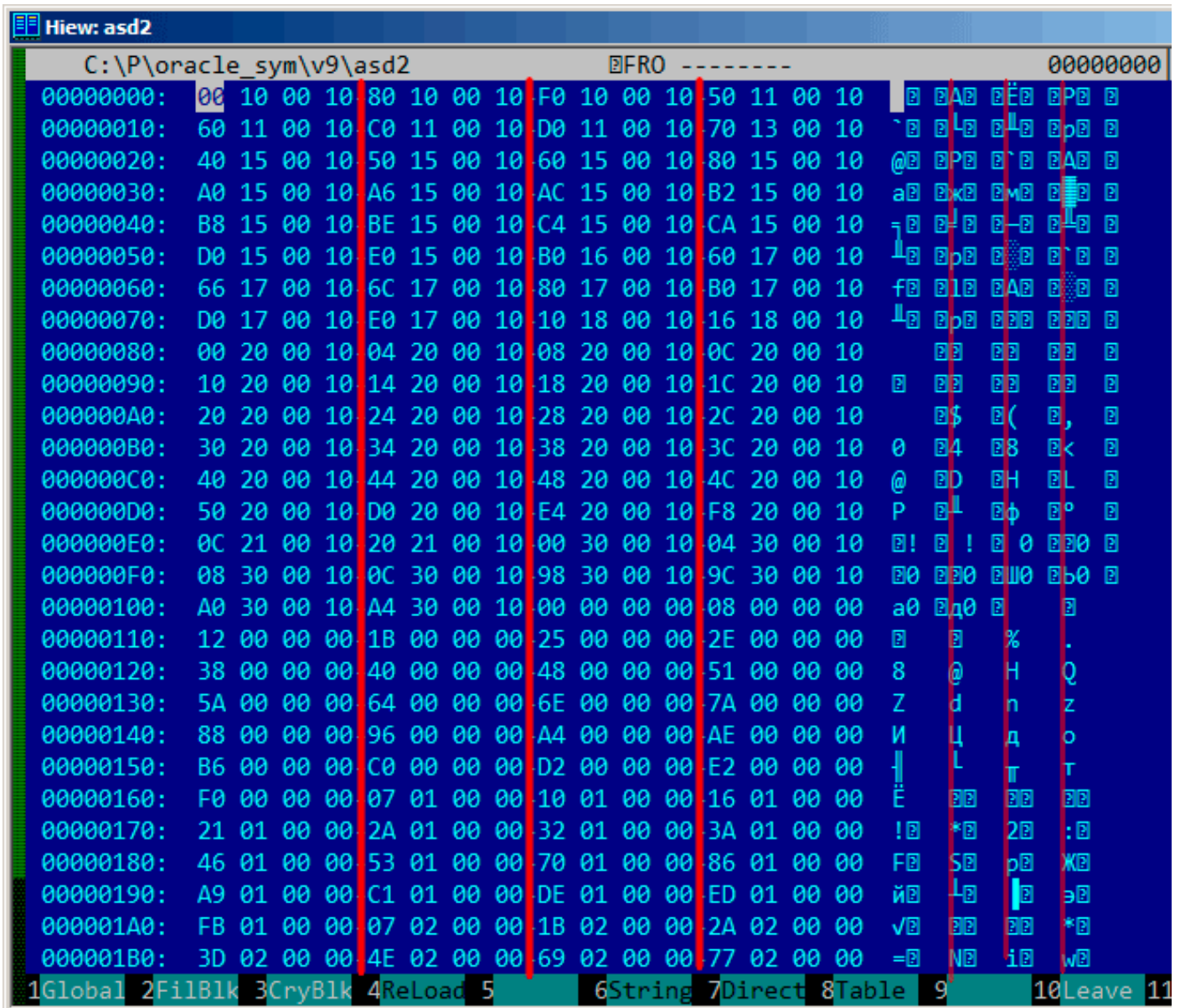

Figure 9.25: Binary block patterns

Hiew, like almost any other hexadecimal editor, shows 16 bytes per line. So the pattern is clearly visible: there are 4 32-bit values per line.

The pattern is visually visible because some values here (till address 0x104) are always in 0x1000xxxx form, started with 0x10 and zero bytes.

Other values (starting at 0x108) are in 0x0000xxxx form, so always started with two zero bytes.

Let's dump the block as an array of 32-bit values:

Listing 9.9: first column is address

```
$ od -v -t x4 binary_block
0000000 10001000 10001080 100010f0 10001150
0000020 10001160 100011c0 100011d0 10001370
0000040 10001540 10001550 10001560 10001580
0000060 100015a0 100015a6 100015ac 100015b2
0000100 100015b8 100015be 100015c4 100015ca
0000120 100015d0 100015e0 100016b0 10001760
0000140 10001766 1000176c 10001780 100017b0
0000160 100017d0 100017e0 10001810 10001816
0000200 10002000 10002004 10002008 1000200c
0000220 10002010 10002014 10002018 1000201c
```



```

0000240 10002020 10002024 10002028 1000202c
0000260 10002030 10002034 10002038 1000203c
0000300 10002040 10002044 10002048 1000204c
0000320 10002050 100020d0 100020e4 100020f8
0000340 1000210c 10002120 10003000 10003004
0000360 10003008 1000300c 10003098 1000309c
0000400 100030a0 100030a4 00000000 00000008
0000420 00000012 0000001b 00000025 0000002e
0000440 00000038 00000040 00000048 00000051
0000460 0000005a 00000064 0000006e 0000007a
0000500 00000088 00000096 000000a4 000000ae
0000520 000000b6 000000c0 000000d2 000000e2
0000540 000000f0 00000107 00000110 00000116
0000560 00000121 0000012a 00000132 0000013a
0000600 00000146 00000153 00000170 00000186
0000620 000001a9 000001c1 000001de 000001ed
0000640 000001fb 00000207 0000021b 0000022a
0000660 0000023d 0000024e 00000269 00000277
0000700 00000287 00000297 000002b6 000002ca
0000720 000002dc 000002f0 00000304 00000321
0000740 0000033e 0000035d 0000037a 00000395
0000760 000003ae 000003b6 000003be 000003c6
0001000 000003ce 000003dc 000003e9 000003f8
0001020

```

There are 132 values, that's 66\*2. Probably, there are two 32-bit values for each symbol, but maybe there are two arrays? Let's see.

Values starting with 0x1000 may be addresses.

This is a .SYM file for a DLL after all, and the default base address of win32 DLLs is 0x10000000, and the code usually starts at 0x10001000.

When we open the orawtc8.dll file in [IDA](#), the base address is different, but nevertheless, the first function is:

```

.text:60351000 sub_60351000    proc near
.text:60351000
.text:60351000 arg_0      = dword ptr 8
.text:60351000 arg_4      = dword ptr 0Ch
.text:60351000 arg_8      = dword ptr 10h
.text:60351000
.text:60351000         push   ebp
.text:60351001         mov    ebp, esp
.text:60351003         mov    eax, dword_60353014
.text:60351008         cmp    eax, 0FFFFFFFFh
.text:6035100B         jnz   short loc_6035104F
.text:6035100D         mov    ecx, hModule
.text:60351013         xor    eax, eax
.text:60351015         cmp    ecx, 0FFFFFFFFh
.text:60351018         mov    dword_60353014, eax
.text:6035101D         jnz   short loc_60351031
.text:6035101F         call  sub_603510F0
.text:60351024         mov    ecx, eax
.text:60351026         mov    eax, dword_60353014
.text:6035102B         mov    hModule, ecx
.text:60351031
.text:60351031 loc_60351031:    ; CODE XREF: sub_60351000+1D
.text:60351031         test   ecx, ecx
.text:60351033         jbe   short loc_6035104F
.text:60351035         push  offset ProcName ; "ax_reg"
.text:6035103A         push  ecx              ; hModule
.text:6035103B         call  ds:GetProcAddress
...

```

Wow, "ax\_reg" string sounds familiar.

It's indeed the first string in the strings block! So the name of this function seems to be "ax\_reg".

The second function is:

```

.text:60351080 sub_60351080    proc near
.text:60351080
.text:60351080 arg_0      = dword ptr  8
.text:60351080 arg_4      = dword ptr  0Ch
.text:60351080
.text:60351080         push   ebp
.text:60351081         mov    ebp, esp
.text:60351083         mov    eax, dword_60353018
.text:60351088         cmp    eax, 0FFFFFFFFh
.text:6035108B         jnz    short loc_603510CF
.text:6035108D         mov    ecx, hModule
.text:60351093         xor    eax, eax
.text:60351095         cmp    ecx, 0FFFFFFFFh
.text:60351098         mov    dword_60353018, eax
.text:6035109D         jnz    short loc_603510B1
.text:6035109F         call  sub_603510F0
.text:603510A4         mov    ecx, eax
.text:603510A6         mov    eax, dword_60353018
.text:603510AB         mov    hModule, ecx
.text:603510B1
.text:603510B1 loc_603510B1:    ; CODE XREF: sub_60351080+1D
.text:603510B1         test   ecx, ecx
.text:603510B3         jbe    short loc_603510CF
.text:603510B5         push  offset aAx_unreg ; "ax_unreg"
.text:603510BA         push  ecx              ; hModule
.text:603510BB         call  ds:GetProcAddress
...

```

The “ax\_unreg” string is also the second string in the strings block!

The starting address of the second function is 0x60351080, and the second value in the binary block is 10001080. So this is the address, but for a DLL with the default base address.

We can quickly check and be sure that the first 66 values in the array (i.e., the first half of the array) are just function addresses in the DLL, including some labels, etc. Well, what’s the other part of array then? The other 66 values that start with 0x0000? These seem to be in range [0..0x3F8]. And they do not look like bitfields: the series of numbers is increasing.

The last hexadecimal digit seems to be random, so, it’s unlikely the address of something (it would be divisible by 4 or maybe 8 or 0x10 otherwise).

Let’s ask ourselves: what else Oracle RDBMS’s developers would save here, in this file?

Quick wild guess: it could be the address of the text string (function name).

It can be quickly checked, and yes, each number is just the position of the first character in the strings block.

This is it! All done.

We will write an utility to convert these .SYM files into [IDA](#) script, so we can load the .idc script and it sets the function names:

```

#include <stdio.h>
#include <stdint.h>
#include <io.h>
#include <assert.h>
#include <malloc.h>
#include <fcntl.h>
#include <string.h>

int main (int argc, char *argv[])
{
    uint32_t sig, cnt, offset;
    uint32_t *d1, *d2;
    int      h, i, remain, file_len;
    char     *d3;
    uint32_t array_size_in_bytes;

    assert (argv[1]); // file name
    assert (argv[2]); // additional offset (if needed)

```

```

// additional offset
assert (sscanf (argv[2], "%X", &offset)==1);

// get file length
assert ((h=open (argv[1], _O_RDONLY | _O_BINARY, 0))!=-1);
assert ((file_len=lseek (h, 0, SEEK_END))!=-1);
assert (lseek (h, 0, SEEK_SET)!=-1);

// read signature
assert (read (h, &sig, 4)==4);
// read count
assert (read (h, &cnt, 4)==4);

assert (sig==0x4D59534F); // OSYM

// skip timedatestamp (for llg)
//_lseek (h, 4, 1);

array_size_in_bytes=cnt*sizeof(uint32_t);

// load symbol addresses array
d1=(uint32_t*)malloc (array_size_in_bytes);
assert (d1);
assert (read (h, d1, array_size_in_bytes)==array_size_in_bytes);

// load string offsets array
d2=(uint32_t*)malloc (array_size_in_bytes);
assert (d2);
assert (read (h, d2, array_size_in_bytes)==array_size_in_bytes);

// calculate strings block size
remain=file_len-(8+4)-(cnt*8);

// load strings block
assert (d3=(char*)malloc (remain));
assert (read (h, d3, remain)==remain);

printf ("#include <idc.idc>\n\n");
printf ("static main() {\n");

for (i=0; i<cnt; i++)
    printf ("\tMakeName(0x%08X, \"%s\");\n", offset + d1[i], &d3[d2[i]]);

printf ("}\n");

close (h);
free (d1); free (d2); free (d3);
};

```

Here is an example of its work:

```

#include <idc.idc>

static main() {
    MakeName(0x60351000, "_ax_reg");
    MakeName(0x60351080, "_ax_unreg");
    MakeName(0x603510F0, "_loaddll");
    MakeName(0x60351150, "_wtcsrino");
    MakeName(0x60351160, "_wtcsrino");
    MakeName(0x603511C0, "_wtcsrfr");
    MakeName(0x603511D0, "_wtclkm");
    MakeName(0x60351370, "_wtcstu");
    ...
}

```

The example files were used in this example are here: [beginners.re](http://beginners.re).

Oh, let's also try Oracle RDBMS for win64. There has to be 64-bit addresses instead, right? The 8-byte pattern is visible even easier here:

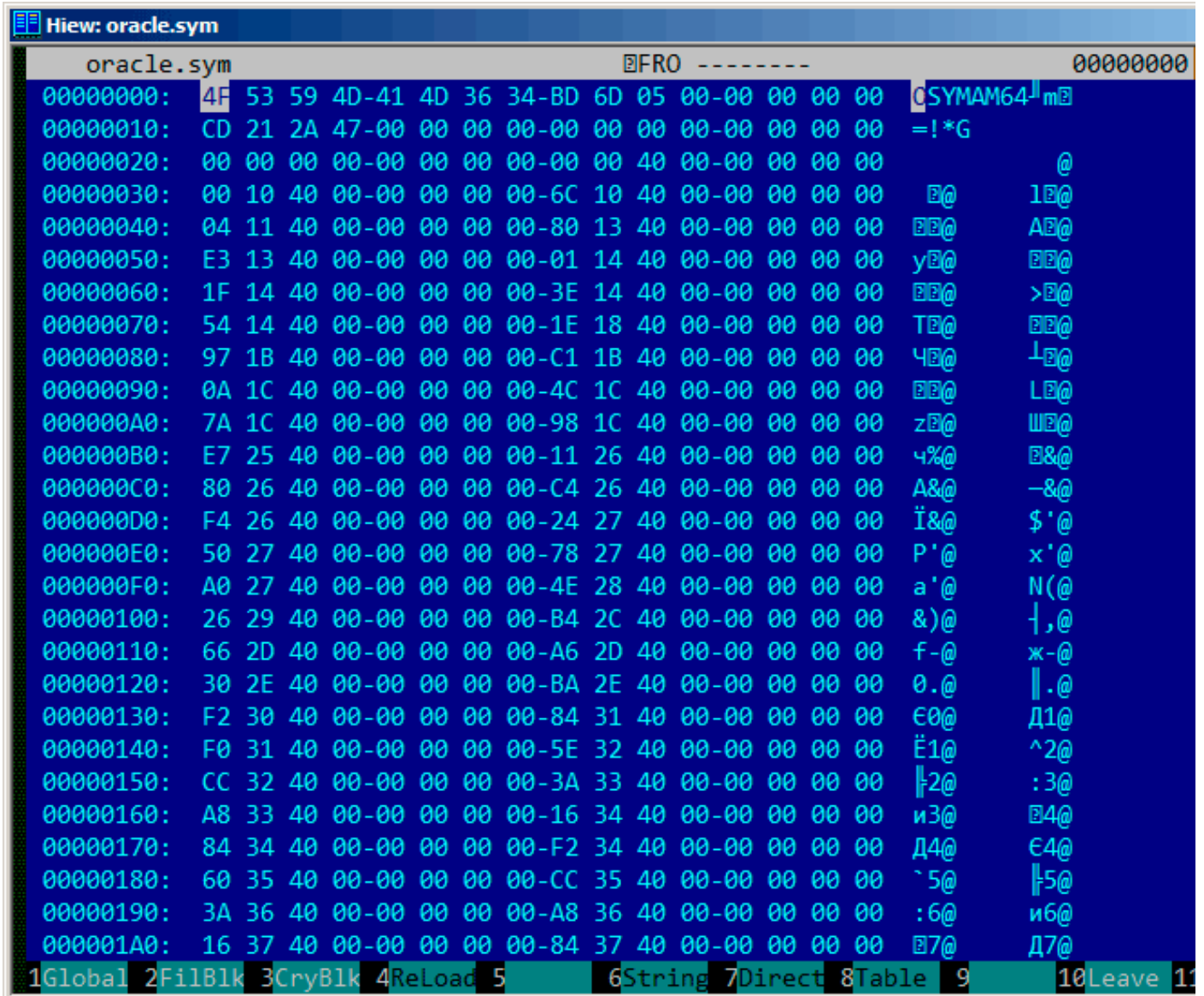

Figure 9.26: .SYM-file example from Oracle RDBMS for win64

So yes, all tables now have 64-bit elements, even string offsets! The signature is now OSYMM64, to distinguish the target platform, apparently. This is it!

Here is also library which has functions to access Oracle RDBMS.SYM-files: [GitHub](#).

## 9.6 Oracle RDBMS: .MSB-files

When working toward the solution of a problem, it always helps if you know the answer.

Murphy's Laws, Rule of Accuracy

This is a binary file that contains error messages with their corresponding numbers. Let's try to understand its format and find a way to unpack it.

There are Oracle RDBMS error message files in text form, so we can compare the text and packed binary files <sup>13</sup>.

This is the beginning of the ORAUS.MSG text file with some irrelevant comments stripped:

Listing 9.10: Beginning of ORAUS.MSG file without comments

```
00000, 00000, "normal, successful completion"
00001, 00000, "unique constraint (%s.%s) violated"
00017, 00000, "session requested to set trace event"
00018, 00000, "maximum number of sessions exceeded"
00019, 00000, "maximum number of session licenses exceeded"
00020, 00000, "maximum number of processes (%s) exceeded"
00021, 00000, "session attached to some other process; cannot switch session"
00022, 00000, "invalid session ID; access denied"
00023, 00000, "session references process private memory; cannot detach session"
00024, 00000, "logins from more than one process not allowed in single-process mode"
00025, 00000, "failed to allocate %s"
00026, 00000, "missing or invalid session ID"
00027, 00000, "cannot kill current session"
00028, 00000, "your session has been killed"
00029, 00000, "session is not a user session"
00030, 00000, "User session ID does not exist."
00031, 00000, "session marked for kill"
...
```

The first number is the error code. The second is perhaps maybe some additional flags.

<sup>13</sup>Open-source text files don't exist in Oracle RDBMS for every .MSB file, so that's why we will work on their file format

Now let's open the ORAUS.MSB binary file and find these text strings. And there are:

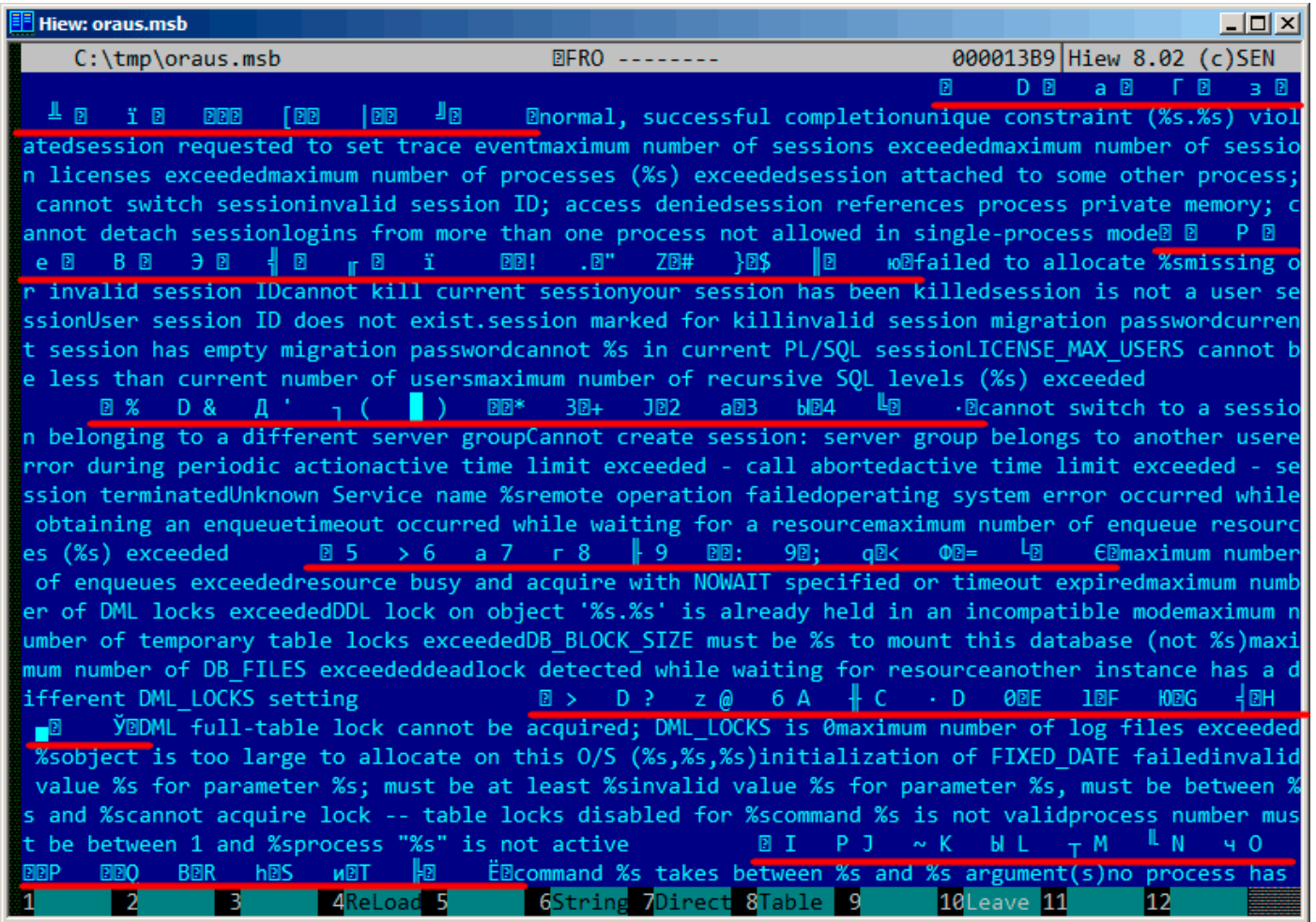

Figure 9.27: Hiew: first block

We see the text strings (including those from the beginning of the ORAUS.MSG file) interleaved with some binary values. By quick investigation, we can see that main part of the binary file is divided by blocks of size 0x200 (512) bytes.

Let's see the contents of the first block:

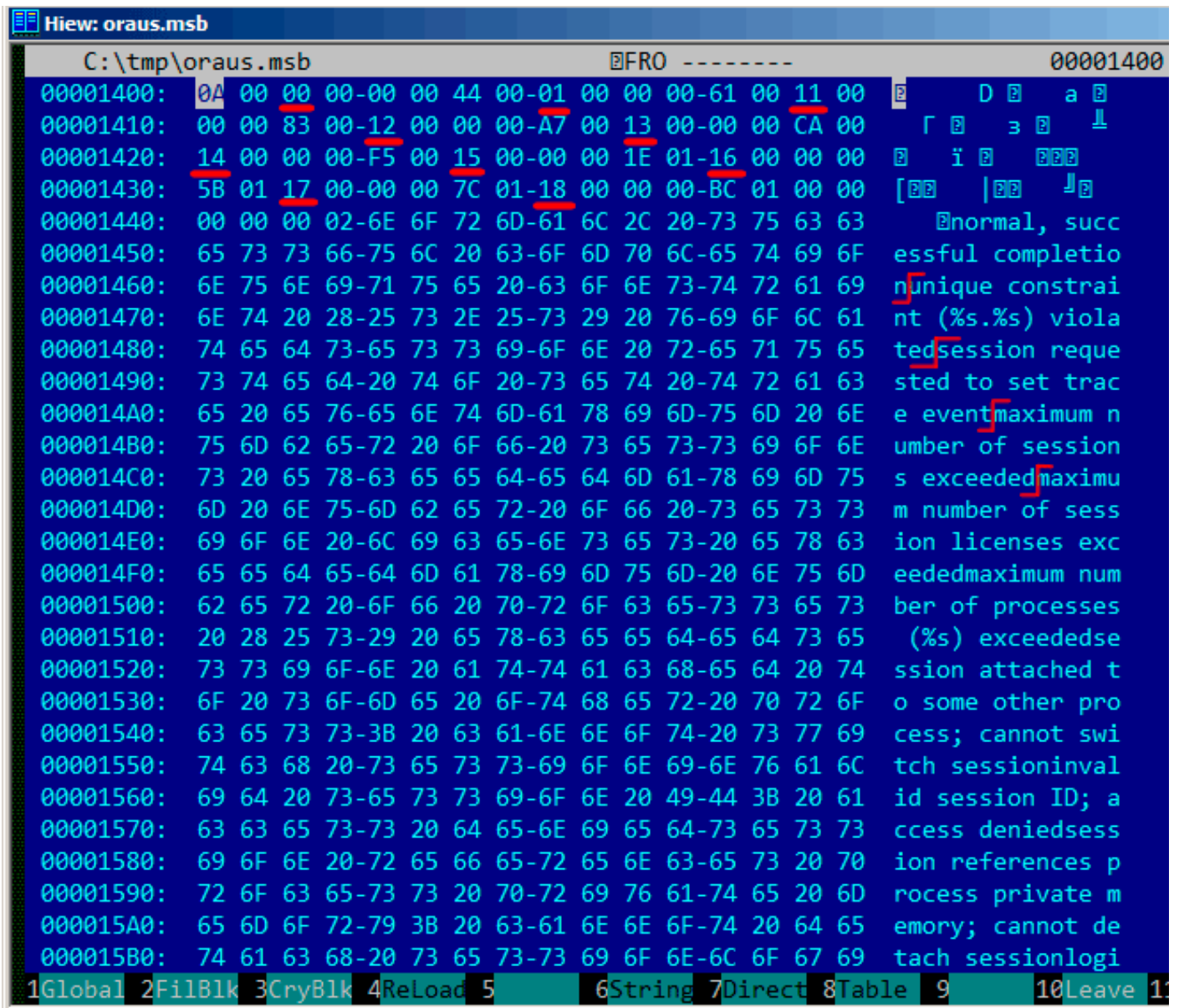

Figure 9.28: Hiew: first block

Here we see the texts of the first messages errors. What we also see is that there are no zero bytes between the error messages. This implies that these are not null-terminated C strings. As a consequence, the length of each error message must be encoded somehow. Let's also try to find the error numbers. The ORAUS.MSG files starts with these: 0, 1, 17 (0x11), 18 (0x12), 19 (0x13), 20 (0x14), 21 (0x15), 22 (0x16), 23 (0x17), 24 (0x18)... We will find these numbers at the beginning of the block and mark them with red lines. The period between error codes is 6 bytes.

This implies that there are probably 6 bytes of information allocated for each error message.

The first 16-bit value (0xA here or 10) means the number of messages in each block: this can be checked by investigating other blocks. Indeed: the error messages have arbitrary size. Some are longer, some are shorter. But block size is always fixed, hence, you never know how many text messages can be packed in each block.

As we already noted, since these are not null-terminated C strings, their size must be encoded somewhere. The size of the first string "normal, successful completion" is 29 (0x1D) bytes. The size of the second string "unique constraint (%s.%s) violated" is 34 (0x22) bytes. We can't find these values (0x1D or/and 0x22) in the block.

There is also another thing. Oracle RDBMS has to determine the position of the string it needs to load in the block, right? The first string "normal, successful completion" starts at position 0x1444 (if we count starting at the beginning of the file) or at 0x44 (from the block's start). The second string "unique constraint

(%s.%s) violated” starts at position 0x1461 (from the file’s start) or at 0x61 (from the at the block’s start). These numbers (0x44 and 0x61) are familiar somehow! We can clearly see them at the start of the block.

So, each 6-byte block is:

- 16-bit error number;
- 16-bit zero (maybe additional flags);
- 16-bit starting position of the text string within the current block.

We can quickly check the other values and be sure our guess is correct. And there is also the last “dummy” 6-byte block with an error number of zero and starting position beyond the last error message’s last character. Probably that’s how text message length is determined? We just enumerate 6-byte blocks to find the error number we need, then we get the text string’s position, then we get the position of the text string by looking at the next 6-byte block! This way we determine the string’s boundaries! This method allows to save some space by not saving the text string’s size in the file!

It’s not possible to say it saves a lot of space, but it’s a clever trick.



Let's back to the header of .MSB-file:

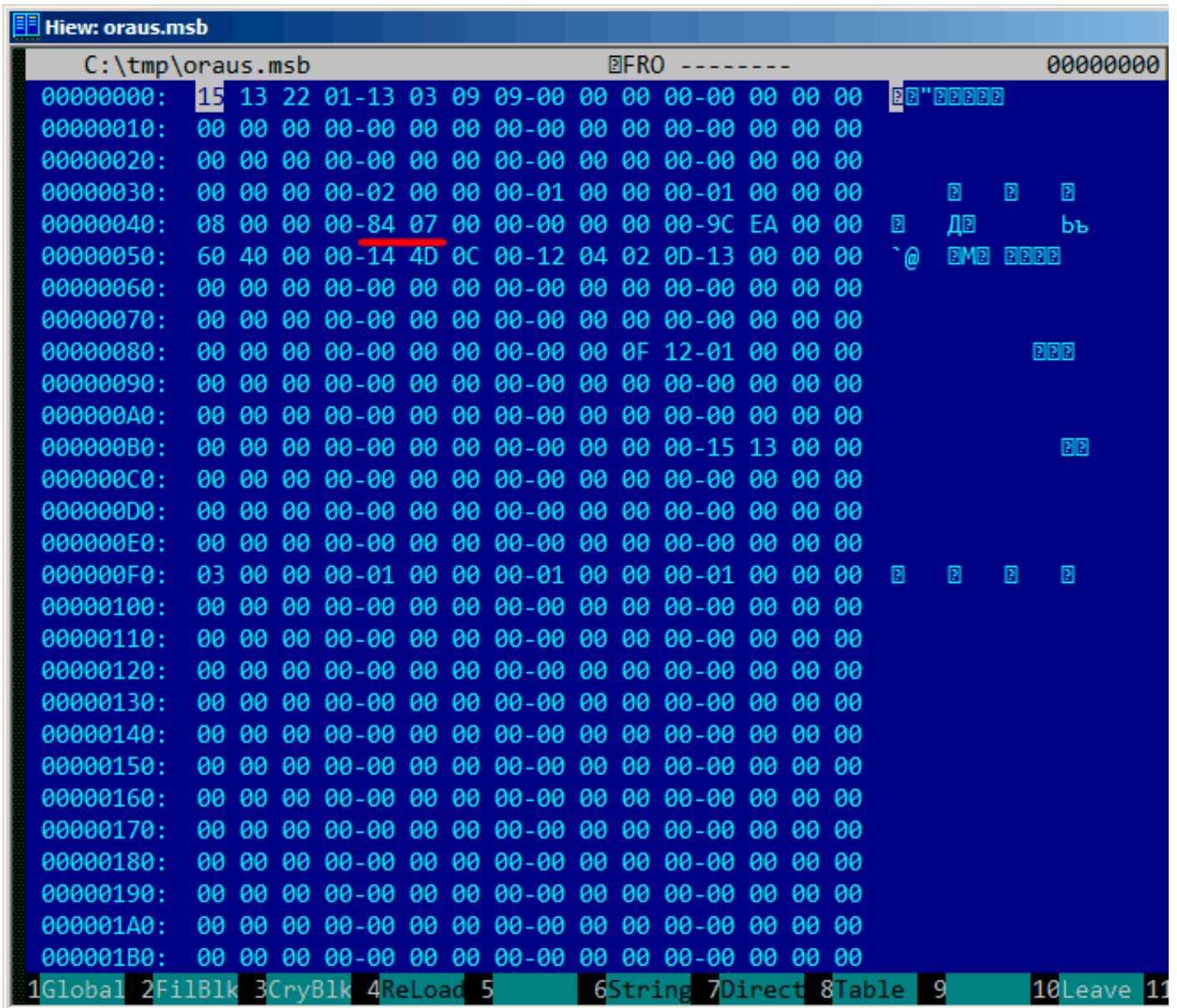

Figure 9.29: Hiew: file header

Now we can quickly find the number of blocks in the file (marked by red). We can checked other .MSB-files and we see that it's true for all of them.

There are a lot of other values, but we will not investigate them, since our job (an unpacking utility) is done.

If we have to write a .MSB file packer, we would probably have to understand the meaning of the other values.

There is also a table that came after the header which probably contains 16-bit values:

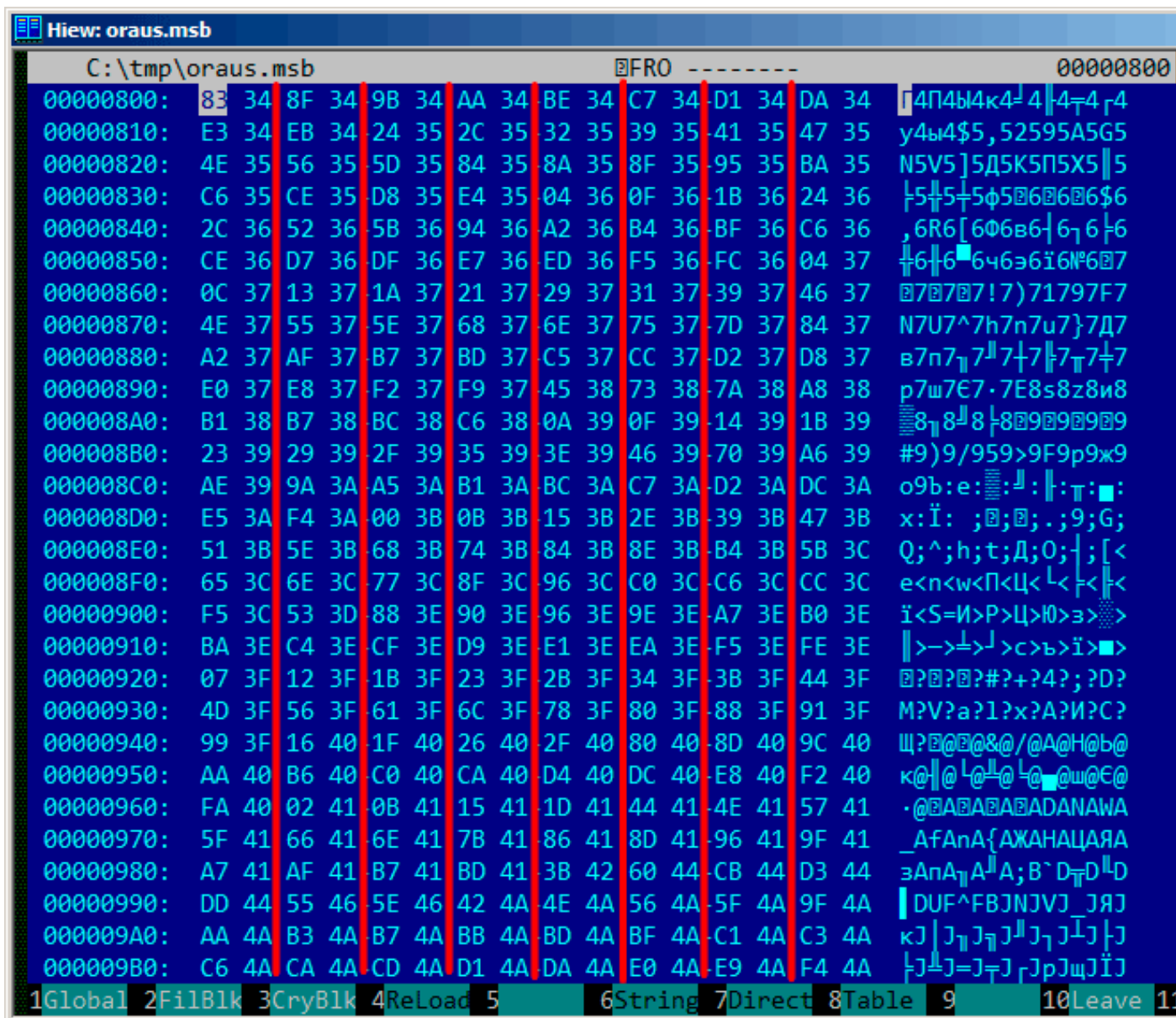

Figure 9.30: Hiew: last\_ernos table

Their size can be determined visually (red lines are drawn here).

While dumping these values, we have found that each 16-bit number is the last error code for each block.

So that's how Oracle RDBMS quickly finds the error message:

- load a table we will call last\_ernos (that contains the last error number for each block);
- find a block that contains the error code we need, assuming all error codes increase across each block and across the file as well;
- load the specific block;
- enumerate the 6-byte structures until the specific error number is found;
- get the position of the first character from the current 6-byte block;
- get the position of the last character from the next 6-byte block;
- load all characters of the message in this range.

This is C program that we wrote which unpacks .MSB-files: [beginners.re](#).

There are also the two files which were used in the example (Oracle RDBMS 11.1.0.6): [beginners.re](#), [beginners.re](#).

### 9.6.1 Summary

The method is probably too old-school for modern computers. Supposedly, this file format was developed in the mid-80's by someone who also coded for *big iron* with memory/disk space economy in mind. Nevertheless, it has been an interesting and yet easy task to understand a proprietary file format without looking into Oracle RDBMS's code.

## 9.7 Exercises

Try to reverse engineer of any binary files of your favorite game, including high-score files, resources, etc. There are also binary files with known structure: utmp/wtmp files, try to understand its structure without documentation.

The EXIF header in JPEG file is documented, but you can try to understand its structure without help, just shoot photos at various date/time, places, and try to find date/time and GPS location in EXIF. Try to patch GPS location, upload JPEG file to Facebook and see, how it will put your picture on the map.

Try to patch any information in MP3 file and see how your favorite MP3-player will react.

## 9.8 Further reading

[Pierre Capillon - Black-box cryptanalysis of home-made encryption algorithms: a practical case study.](#)  
[How to Hack an Expensive Camera and Not Get Killed by Your Wife.](#)

# Chapter 10

## Dynamic binary instrumentation

DBI tools can be viewed as highly advanced and fast debuggers.

### 10.1 Using PIN DBI for XOR interception

PIN from Intel is a DBI tool. That means, it takes compiled binary and inserts your instructions in it, where you want.

Let's try to intercept all XOR instructions. These are heavily used in cryptography, and we can try to run WinRAR archiver in encryption mode with a hope that some XOR instruction is indeed is used while encryption.

Here is the source code of my PIN tool: [https://beginners.re/current-tree/DBI/XOR/files//XOR\\_ins.cpp](https://beginners.re/current-tree/DBI/XOR/files//XOR_ins.cpp).

The code is almost self-explanatory: it scans input executable file for all XOR/PXOR instructions and inserts a call to our function before each. `log_info()` function first checks, if operands are different (since XOR is often used just to clear register, like XOR EAX, EAX), and if they are different, it increments a counter at this EIP/RIP, so the statistics will be gathered.

I have prepared two files for test: `test1.bin` (30720 bytes) and `test2.bin` (5547752 bytes), I'll compress them by RAR with password and see difference in statistics.

You'll also need to turn off [ASLR](#)<sup>1</sup>, so the PIN tool will report the same RIPs as in RAR executable.

Now let's run it:

```
c:\pin-3.2-81205-msvc-windows\pin.exe -t XOR_ins.dll -- rar a -pLongPassword tmp.rar test1.bin
c:\pin-3.2-81205-msvc-windows\pin.exe -t XOR_ins.dll -- rar a -pLongPassword tmp.rar test2.bin
```

Now here is statistics for the `test1.bin`:

[https://beginners.re/current-tree/DBI/XOR/files//XOR\\_ins.out.test1](https://beginners.re/current-tree/DBI/XOR/files//XOR_ins.out.test1). ... and for `test2.bin`: [https://beginners.re/current-tree/DBI/XOR/files//XOR\\_ins.out.test2](https://beginners.re/current-tree/DBI/XOR/files//XOR_ins.out.test2). So far, you can ignore all addresses other than `ip=0x1400xxxxx`, which are in other DLLs.

Now let's see a difference: [https://beginners.re/current-tree/DBI/XOR/files//XOR\\_ins.diff](https://beginners.re/current-tree/DBI/XOR/files//XOR_ins.diff).

Some XOR instructions are executed more often for `test2.bin` (which is bigger) than for `test1.bin` (which is smaller). So these are clearly related to file size!

The first block of differences is:

```
< ip=0x140017b21 count=0xd84
< ip=0x140017b48 count=0x81f
< ip=0x140017b59 count=0x858
< ip=0x140017b6a count=0xc13
< ip=0x140017b7b count=0xefc
< ip=0x140017b8a count=0xefd
< ip=0x140017b92 count=0xb86
```

<sup>1</sup><https://stackoverflow.com/q/9560993>

```

< ip=0x140017ba1 count=0xf01
---
> ip=0x140017b21 count=0x9eab5
> ip=0x140017b48 count=0x79863
> ip=0x140017b59 count=0x862e8
> ip=0x140017b6a count=0x99495
> ip=0x140017b7b count=0xa891c
> ip=0x140017b8a count=0xa89f4
> ip=0x140017b92 count=0x8ed72
> ip=0x140017ba1 count=0xa8a8a

```

This is indeed some kind of loop inside of RAR.EXE:

```

.text:0000000140017B21 loc_140017B21:
.text:0000000140017B21          xor     r11d, [rbx]
.text:0000000140017B24          mov     r9d, [rbx+4]
.text:0000000140017B28          add     rbx, 8
.text:0000000140017B2C          mov     eax, r9d
.text:0000000140017B2F          shr     eax, 18h
.text:0000000140017B32          movzx  edx, al
.text:0000000140017B35          mov     eax, r9d
.text:0000000140017B38          shr     eax, 10h
.text:0000000140017B3B          movzx  ecx, al
.text:0000000140017B3E          mov     eax, r9d
.text:0000000140017B41          shr     eax, 8
.text:0000000140017B44          mov     r8d, [rsi+rdx*4]
.text:0000000140017B48          xor     r8d, [rsi+rcx*4+400h]
.text:0000000140017B50          movzx  ecx, al
.text:0000000140017B53          mov     eax, r11d
.text:0000000140017B56          shr     eax, 18h
.text:0000000140017B59          xor     r8d, [rsi+rcx*4+800h]
.text:0000000140017B61          movzx  ecx, al
.text:0000000140017B64          mov     eax, r11d
.text:0000000140017B67          shr     eax, 10h
.text:0000000140017B6A          xor     r8d, [rsi+rcx*4+1000h]
.text:0000000140017B72          movzx  ecx, al
.text:0000000140017B75          mov     eax, r11d
.text:0000000140017B78          shr     eax, 8
.text:0000000140017B7B          xor     r8d, [rsi+rcx*4+1400h]
.text:0000000140017B83          movzx  ecx, al
.text:0000000140017B86          movzx  eax, r9b
.text:0000000140017B8A          xor     r8d, [rsi+rcx*4+1800h]
.text:0000000140017B92          xor     r8d, [rsi+rax*4+0C00h]
.text:0000000140017B9A          movzx  eax, r11b
.text:0000000140017B9E          mov     r11d, r8d
.text:0000000140017BA1          xor     r11d, [rsi+rax*4+1C00h]
.text:0000000140017BA9          sub     rdi, 1
.text:0000000140017BAD          jnz    loc_140017B21

```

What does it do? No idea yet.

The next:

```

< ip=0x14002c4f1 count=0x4fce
---
> ip=0x14002c4f1 count=0x4463be

```

0x4fce is 20430, which is close to size of test1.bin (30720 bytes). 0x4463be is 4481982 which is close to size of test2.bin (5547752 bytes). Not equal, but close.

This is a piece of code with that XOR instruction:

```

.text:000000014002C4EA loc_14002C4EA:
.text:000000014002C4EA          movzx  eax, byte ptr [r8]
.text:000000014002C4EE          shl     ecx, 5
.text:000000014002C4F1          xor     ecx, eax

```

```
.text:000000014002C4F3      and     ecx, 7FFFh
.text:000000014002C4F9      cmp     [r11+rcx*4], esi
.text:000000014002C4FD      jb     short loc_14002C507
.text:000000014002C4FF      cmp     [r11+rcx*4], r10d
.text:000000014002C503      ja     short loc_14002C507
.text:000000014002C505      inc     ebx
```

Loop body can be written as:

```
state = input_byte ^ (state<<5) & 0x7FFF}.
```

*state* is then used as index in some table. Is this some kind of [CRC<sup>2</sup>](#)? I don't know, but this could be a checksumming routine. Or maybe optimized [CRC](#) routine? Any ideas?

The next block:

```
< ip=0x14004104a count=0x367
< ip=0x140041057 count=0x367
---
> ip=0x14004104a count=0x24193
> ip=0x140041057 count=0x24193
```

```
.text:0000000140041039 loc_140041039:
.text:0000000140041039      mov     rax, r10
.text:000000014004103C      add     r10, 10h
.text:0000000140041040      cmp     byte ptr [rcx+1], 0
.text:0000000140041044      movdqu xmm0, xmmword ptr [rax]
.text:0000000140041048      jz     short loc_14004104E
.text:000000014004104A      pxor   xmm0, xmm1
.text:000000014004104E      loc_14004104E:
.text:000000014004104E      movdqu xmm1, xmmword ptr [rcx+18h]
.text:0000000140041053      movsxd r8, dword ptr [rcx+4]
.text:0000000140041057      pxor   xmm1, xmm0
.text:000000014004105B      cmp     r8d, 1
.text:000000014004105F      jle    short loc_14004107C
.text:0000000140041061      lea    rdx, [rcx+28h]
.text:0000000140041065      lea    r9d, [r8-1]
.text:0000000140041069      loc_140041069:
.text:0000000140041069      movdqu xmm0, xmmword ptr [rdx]
.text:000000014004106D      lea    rdx, [rdx+10h]
.text:0000000140041071      aesenc xmm1, xmm0
.text:0000000140041076      sub    r9, 1
.text:000000014004107A      jnz    short loc_140041069
.text:000000014004107C
```

This piece has both PXOR and AESENC instructions (the last is [AES<sup>3</sup>](#) encryption instruction). So yes, we found encryption function, RAR uses [AES](#).

There is also another big block of almost contiguous XOR instructions:

```
< ip=0x140043e10 count=0x23006
---
> ip=0x140043e10 count=0x23004
499c510
< ip=0x140043e56 count=0x22ffd
---
> ip=0x140043e56 count=0x23002
```

<sup>2</sup>Cyclic redundancy check

<sup>3</sup>Advanced Encryption Standard

But, its count is not very different during compressing/encrypting test1.bin/test2.bin. What is on these addresses?

```
.text:0000000140043E07      xor     ecx, r9d
.text:0000000140043E0A      mov     r11d, eax
.text:0000000140043E0D      and     ecx, r10d
.text:0000000140043E10      xor     ecx, r8d
.text:0000000140043E13      rol     eax, 8
.text:0000000140043E16      and     eax, esi
.text:0000000140043E18      ror     r11d, 8
.text:0000000140043E1C      add     edx, 5A827999h
.text:0000000140043E22      ror     r10d, 2
.text:0000000140043E26      add     r8d, 5A827999h
.text:0000000140043E2D      and     r11d, r12d
.text:0000000140043E30      or      r11d, eax
.text:0000000140043E33      mov     eax, ebx
```

Let's google 5A827999h constant... this looks like SHA-1! But why would RAR use SHA-1 during encryption?

Here is the answer:

```
In comparison, WinRAR uses its own key derivation scheme that requires (password length * 2 + ↵
↳ 11)*4096 SHA-1 transformations. 'Thats why it takes longer to brute-force attack ↵
↳ encrypted WinRAR archives.
```

( <http://www.tomshardware.com/reviews/password-recovery-gpu,2945-8.html> )

This is key scheduling: input password hashed many times and the hash is then used as AES key. This is why we see the count of XOR instruction is almost unchanged during we switched to bigger test file.

This is it, it took couple of hours for me to write this tool and to get at least 3 points: 1) probably check-summing; 2) AES encryption; 3) SHA-1 calculation. The first function is still unknown for me.

Still, this is impressive, because I didn't dig into RAR code (which is proprietary, of course). I didn't even peek into UnRAR source code (which is available).

The files, including test files and RAR executable I've used (win64, 5.40):  
<https://beginners.re/current-tree/DBI/XOR/files/>.

## 10.2 Cracking Minesweeper with PIN

In this book, I wrote about cracking Minesweeper for Windows XP: [8.4 on page 805](#).

The Minesweeper in Windows Vista and 7 is different: probably it was (re)written to C++, and a cell information is now stored not in global array, but rather in malloc'ed heap blocks.

This is a case when we can try PIN DBI tool.

### 10.2.1 Intercepting all rand() calls

First, since Minesweeper places mines randomly, it has to call rand() or similar function. Let's intercept all rand() calls: <https://beginners.re/current-tree/DBI/minesweeper/minesweeper1.cpp>.

Now we can run it:

```
c:\pin-3.2-81205-msvc-windows\pin.exe -t minesweeper1.dll -- C:\PATH\T0\MineSweeper.exe
```

During startup, PIN searches for all calls to rand() function and adds a hook right after each call. The hook is the RandAfter() function we defined: it is logging about return value and also about return address. Here is a log I got during run of standard 9\*9 configuration (10 mines): <https://beginners.re/current-tree/DBI/minesweeper/minesweeper1.out.10mines>. The rand() function was called many times from several places, but was called from 0x10002770d just 10 times. I switched Minesweeper to 16\*16 configuration (40 mines) and rand() was called from 0x10002770d 40 times. So yes, this is our point. When I load

minesweeper.exe (from Windows 7) into IDA and PDB from Microsoft website is fetched, the function which calls rand() at 0x10002770d called Board::placeMines().

### 10.2.2 Replacing rand() calls with our function

Let's now try to replace rand() function with our version, let it always return zero: <https://beginners.re/current-tree/DBI/minesweeper/minesweeper2.cpp>. During startup, PIN replaces all calls to rand() to calls to our function, which writes to log and returns zero. OK, I run it, and clicked on leftmost/topmost cell:

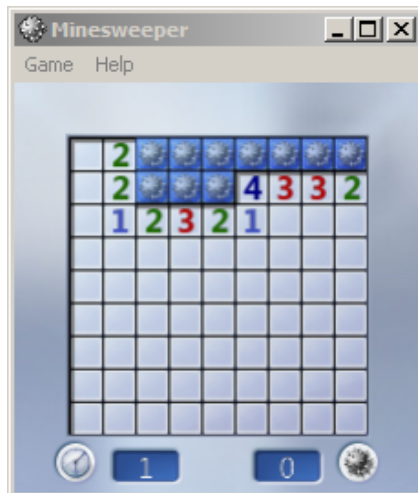

Yes, unlike Minesweeper from Windows XP, mines are placed randomly *after* user's click on cell, so to guarantee there is no mine at the cell user first clicked. So Minesweeper placed mines on cells other than leftmost/topmost (where I clicked).

Now I clicked on rightmost/topmost cell:

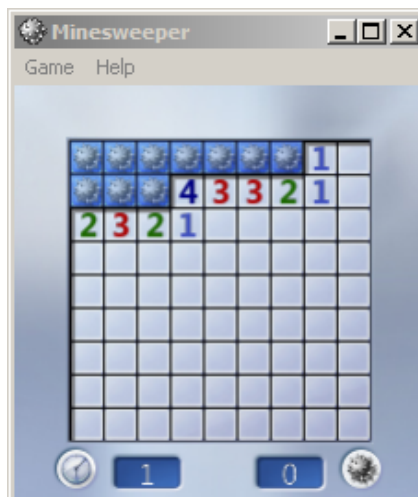

This can be some kind of practical joke? I don't know.

I clicked on 5th cell (right at the middle) at the 1st row:





This is nice, because Minesweeper can do some correct placement even with such a broken PRNG!

### 10.2.3 Peeking into placement of mines

How can we get information about where mines are placed? `rand()`'s result is seems to be useless: it returned zero all the time, but Minesweeper somehow managed to place mines in different cells, though, lined up.

This Minesweeper also written in C++ tradition, so it has no global arrays.

Let us put ourselves in the position of programmer. It has to be loop like:

```
for (int i; i<mines_total; i++)
{
    // get coordinates using rand()
    // put a cell: in other words, modify a block allocated in heap
};
```

How can we get information about heap block which gets modified at the 2nd step? What we need to do: 1) track all heap allocations by intercepting `malloc()/realloc()/free()`. 2) track all memory writes (slow). 3) intercept calls to `rand()`.

Now the algorithm: 1) mark all heap blocks gets modified between 1st and 2nd call to `rand()` from `0x10002770d`; 2) whenever heap block gets freed, dump its contents.

Tracking all memory writes is slow, but after 2nd call to `rand()`, we don't need to track it (since we've got already a list of blocks of interest at this point), so we turn it off.

Now the code: <https://beginners.re/current-tree/DBI/minesweeper/minesweeper3.cpp>.

As it turns out, only 4 heap blocks gets modified between first two `rand()` calls, this is how they looks like:

```
free(0x20aa6360)
free(): we have this block in our records, size=0x28
0x20AA6360: 36 00 00 00 4E 00 00 00-2D 00 00 00 29 00 00 00 "6...N...-...)..."
0x20AA6370: 06 00 00 00 37 00 00 00-35 00 00 00 19 00 00 00 "...7...5....."
0x20AA6380: 46 00 00 00 0B 00 00 00- "F....."

...

free(0x20af9d10)
free(): we have this block in our records, size=0x18
0x20AF9D10: 0A 00 00 00 0A 00 00 00-0A 00 00 00 00 00 00 "....."
0x20AF9D20: 60 63 AA 20 00 00 00 00- "`c. ...."

...

free(0x20b28b20)
free(): we have this block in our records, size=0x140
```

```

0x20B28B20: 02 00 00 00 03 00 00 00-04 00 00 00 05 00 00 00 "....."
0x20B28B30: 07 00 00 00 08 00 00 00-0C 00 00 00 0D 00 00 00 "....."
0x20B28B40: 0E 00 00 00 0F 00 00 00-10 00 00 00 11 00 00 00 "....."
0x20B28B50: 12 00 00 00 13 00 00 00-14 00 00 00 15 00 00 00 "....."
0x20B28B60: 16 00 00 00 17 00 00 00-18 00 00 00 1A 00 00 00 "....."
0x20B28B70: 1B 00 00 00 1C 00 00 00-1D 00 00 00 1E 00 00 00 "....."
0x20B28B80: 1F 00 00 00 20 00 00 00-21 00 00 00 22 00 00 00 ".....!"
0x20B28B90: 23 00 00 00 24 00 00 00-25 00 00 00 26 00 00 00 "#...$.%...&..."
0x20B28BA0: 27 00 00 00 28 00 00 00-2A 00 00 00 2B 00 00 00 "'...(.*...+..."
0x20B28BB0: 2C 00 00 00 2E 00 00 00-2F 00 00 00 30 00 00 00 ",...../...0..."
0x20B28BC0: 31 00 00 00 32 00 00 00-33 00 00 00 34 00 00 00 "1...2...3...4..."
0x20B28BD0: 38 00 00 00 39 00 00 00-3A 00 00 00 3B 00 00 00 "8...9...:...;..."
0x20B28BE0: 3C 00 00 00 3D 00 00 00-3E 00 00 00 3F 00 00 00 "<...=...>...?..."
0x20B28BF0: 40 00 00 00 41 00 00 00-42 00 00 00 43 00 00 00 "@...A...B...C..."
0x20B28C00: 44 00 00 00 45 00 00 00-47 00 00 00 48 00 00 00 "D...E...G...H..."
0x20B28C10: 49 00 00 00 4A 00 00 00-4B 00 00 00 4C 00 00 00 "I...J...K...L..."
0x20B28C20: 4D 00 00 00 4F 00 00 00-50 00 00 00 50 00 00 00 "M...O...P...P..."
0x20B28C30: 50 00 00 00 50 00 00 00-50 00 00 00 50 00 00 00 "P...P...P...P..."
0x20B28C40: 50 00 00 00 50 00 00 00-50 00 00 00 50 00 00 00 "P...P...P...P..."
0x20B28C50: 50 00 00 00 00 00 00 00-00 00 00 00 00 00 00 "P....."

```

...

```

free(0x20af9cf0)
free(): we have this block in our records, size=0x18
0x20AF9CF0: 43 00 00 00 50 00 00 00-10 00 00 00 20 00 74 00 "C...P..... .t."
0x20AF9D00: 20 8B B2 20 00 00 00 00-          " .. .... "

```

We can easily see that the biggest blocks (with size 0x28 and 0x140) are just arrays of values up to  $\approx$  0x50. Wait... 0x50 is 80 in decimal representation. And  $9*9=81$  (standard minesweeper configuration).

After quick investigation, I've found that each 32-bit element is indeed cell coordinate. A cell is represented using a single number, it's a number inside of 2D-array. Row and column of each mine is decoded like that:  $row=n / WIDTH$ ;  $col=n \% HEIGHT$ ;

So when I tried to decode these two biggest blocks, I've got these cell maps:

```

try_to_dump_cells(). unique elements=0xa
.....*..
..*.....
.....*.
.....
.....*..
*.....*
**.....
.....*.
.....*..
...

try_to_dump_cells(). unique elements=0x44
*..****.**
..*****
*****.*
*****
*****.***
.*****.
..*****
*****.*
*****.**

```

It seems that the first block is just a list of mines placed, while the second block is a list of free cells, but, the second is somewhat out of sync with the first one, and it's negative version of the first one coincides only partially. Nevertheless, the first map is correct - we can peek into it in log file when Minesweeper is still loaded and almost all cells are hidden, and click safely on cells marked as dots here.

So it seems, when user first clicked somewhere, Minesweeper places 10 mines, than destroys the block with a list of it (perhaps, it copies all the data to another block before?), so we can see it during free() call.

Another fact: the method `Array<NodeType>::Add(NodeType)` modifies blocks we observed, and is called from various places, including `Board::placeMines()`. But what is cool: I never got into its details, everything has been resolved using just PIN.

The files: <https://beginners.re/current-tree/DBI/minesweeper>.

### 10.2.4 Exercise

Try to understand how `rand()`'s result being converted into coordinate(s). As a practical joke, make `rand()` to output such results, so mines will be placed in shape of some symbol or figure.

## 10.3 Building Pin

Building Pin for Windows may be tricky. This is my working recipe.

- Unpack latest Pin to, say, `C:\pin-3.7\`
- Install latest Cygwin, to, say, `c:\cygwin64`
- Install MSVC 2015 or newer.
- Open file `C:\pin-3.7\source\tools\Config\makefile.default.rules`, replace `mkdir -p $@` to `/bin/mkdir -p $@`
- (If needed) in `C:\pin-3.7\source\tools\SimpleExamples\makefile.rules`, add your pintool to the `TEST_TOOL_ROOTS` list.
- Open "VS2015 x86 Native Tools Command Prompt". Type:

```
cd c:\pin-3.7\source\tools\SimpleExamples
c:\cygwin64\bin\make all TARGET=ia32
```

Now pintools are in `c:\pin-3.7\source\tools\SimpleExamples\obj-ia32`

- For winx64, use "x64 Native Tools Command Prompt" and run:

```
c:\cygwin64\bin\make all TARGET=intel64
```

- Run pintool:

```
c:\pin-3.7\pin.exe -t C:\pin-3.7\source\tools\SimpleExamples\obj-ia32\XOR_ins.dll -- ↵
↳ program.exe arguments
```

## 10.4 Why "instrumentation"?

Perhaps, this is a term of code profiling. There are at least two methods: 1) "sampling": you break into running code as many times as possible (hundreds per second), and see, where it is executed at the moment; 2) "instrumentation": compiled code is interleaved with other code, which can increment counters, etc.

Perhaps, [DBI](#) tools inherited the term?

# Chapter 11

## Other things

### 11.1 Executable files patching

#### 11.1.1 x86 code

Frequent patching tasks are:

- One of the most frequent jobs is to disable some instruction. It is often done by filling it using byte 0x90 (**NOP**).
- Conditional jumps, which have an opcode like 74 xx (**JZ**), can be filled with two **NOPs**.  
It is also possible to disable a conditional jump by writing 0 at the second byte (*jump offset*).
- Another frequent job is to make a conditional jump to always trigger: this can be done by writing 0xEB instead of the opcode, which stands for **JMP**.
- A function's execution can be disabled by writing **RETN** (0xC3) at its beginning. This is true for all functions excluding **stdcall** ( [6.1.2 on page 735](#)). While patching **stdcall** functions, one has to determine the number of arguments (for example, by finding **RETN** in this function), and use **RETN** with a 16-bit argument (0xC2).
- Sometimes, a disabled functions has to return 0 or 1. This can be done by **MOV EAX, 0** or **MOV EAX, 1**, but it's slightly verbose.  
A better way is **XOR EAX, EAX** (2 bytes 0x31 0xC0) or **XOR EAX, EAX / INC EAX** (3 bytes 0x31 0xC0 0x40).

A software may be protected against modifications.

This protection is often done by reading the executable code and calculating a checksum. Therefore, the code must be read before protection is triggered.

This can be determined by setting a breakpoint on reading memory.

**tracer** has the **BPM** option for this.

PE executable file relocs ( [6.5.2 on page 761](#)) must not to be touched while patching, because the Windows loader may overwrite your new code. (They are grayed in Hiew, for example: [fig.1.22](#)).

As a last resort, it is possible to write jumps that circumvent the relocs, or you will have to edit the relocs table.

### 11.2 Function arguments number statistics

I've always been interesting in what is average number of function arguments.

I've analyzed many Windows 7 32-bit DLLs (crypt32.dll, mfc71.dll, msvcrt100.dll, shell32.dll, user32.dll, d3d11.dll, mshtml.dll, msxml6.dll, sqlncli11.dll, wininet.dll, mfc120.dll, msvbvm60.dll, ole32.dll, themeui.dll, wmp.dll) (because they use *stdcall* convention, and so it is easy to *grep* disassembly output just by **RETN X**).

- no arguments:  $\approx 29\%$
- 1 argument:  $\approx 23\%$

- 2 arguments:  $\approx 20\%$
- 3 arguments:  $\approx 11\%$
- 4 arguments:  $\approx 7\%$
- 5 arguments:  $\approx 3\%$
- 6 arguments:  $\approx 2\%$
- 7 arguments:  $\approx 1\%$

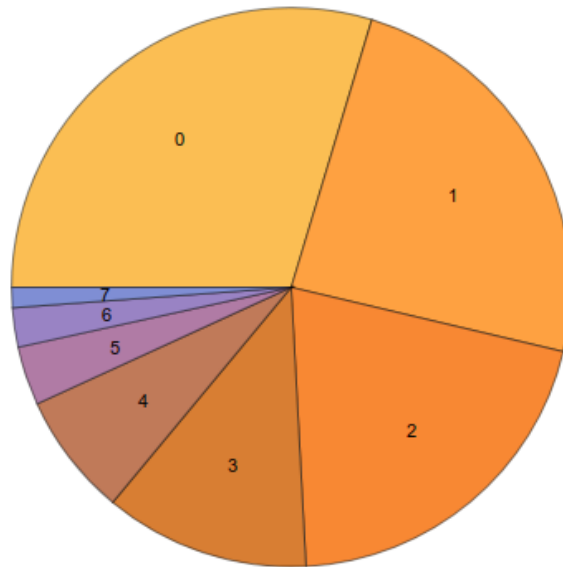

Figure 11.1: Function arguments number statistics

This is heavily dependent on programming style and may be very different for other software products.

## 11.3 Compiler intrinsic

A function specific to a compiler which is not an usual library function. The compiler generates a specific machine code instead of a call to it. It is often a pseudofunction for specific CPU instruction.

For example, there are no cyclic shift operations in C/C++ languages, but they are present in most CPUs. For programmer's convenience, at least MSVC has pseudofunctions `_rotl()` and `_rotr()`<sup>1</sup> which are translated by the compiler directly to the ROL/ROR x86 instructions.

Another example are functions to generate SSE-instructions right in the code.

Full list of MSVC intrinsics: [MSDN](#).

## 11.4 Compiler's anomalies

### 11.4.1 Oracle RDBMS 11.2 and Intel C++ 10.1

Intel C++ 10.1, which was used for Oracle RDBMS 11.2 Linux86 compilation, may emit two JZ in row, and there are no references to the second JZ. The second JZ is thus meaningless.

Listing 11.1: kdli.o from libserver11.a

```
.text:08114CF1          loc_8114CF1: ; CODE XREF: __PG0SF539_kdlimemSer+89A
.text:08114CF1          ; __PG0SF539_kdlimemSer+3994
.text:08114CF1 8B 45 08          mov     eax, [ebp+arg_0]
```

<sup>1</sup>[MSDN](#)

```

.text:08114CF4 0F B6 50 14      movzx  edx, byte ptr [eax+14h]
.text:08114CF8 F6 C2 01      test   dl, 1
.text:08114CFB 0F 85 17 08 00 00  jnz    loc_8115518
.text:08114D01 85 C9      test   ecx, ecx
.text:08114D03 0F 84 8A 00 00 00  jz     loc_8114D93
.text:08114D09 0F 84 09 08 00 00  jz     loc_8115518
.text:08114D0F 8B 53 08      mov    edx, [ebx+8]
.text:08114D12 89 55 FC      mov    [ebp+var_4], edx
.text:08114D15 31 C0      xor    eax, eax
.text:08114D17 89 45 F4      mov    [ebp+var_C], eax
.text:08114D1A 50      push  eax
.text:08114D1B 52      push  edx
.text:08114D1C E8 03 54 00 00  call  len2nbytes
.text:08114D21 83 C4 08      add    esp, 8

```

Listing 11.2: from the same code

```

.text:0811A2A5      loc_811A2A5: ; CODE XREF: kdliSerLengths+11C
.text:0811A2A5      ; kdliSerLengths+1C1
.text:0811A2A5 8B 7D 08      mov    edi, [ebp+arg_0]
.text:0811A2A8 8B 7F 10      mov    edi, [edi+10h]
.text:0811A2AB 0F B6 57 14  movzx  edx, byte ptr [edi+14h]
.text:0811A2AF F6 C2 01      test   dl, 1
.text:0811A2B2 75 3E      jnz    short loc_811A2F2
.text:0811A2B4 83 E0 01      and    eax, 1
.text:0811A2B7 74 1F      jz     short loc_811A2D8
.text:0811A2B9 74 37      jz     short loc_811A2F2
.text:0811A2BB 6A 00      push  0
.text:0811A2BD FF 71 08      push  dword ptr [ecx+8]
.text:0811A2C0 E8 5F FE FF FF  call  len2nbytes

```

It is supposedly a code generator bug that was not found by tests, because resulting code works correctly anyway.

Another example from Oracle RDBMS 11.1.0.6.0 for win32.

```

.text:0051FBF8 85 C0      test   eax, eax
.text:0051FBFA 0F 84 8F 00 00 00  jz     loc_51FC8F
.text:0051FC00 74 1D      jz     short loc_51FC1F

```

## 11.4.2 MSVC 6.0

Just found in some old code:

```

      fabs
      fild    [esp+50h+var_34]
      fabs
      fxch   st(1) ; first instruction
      fxch   st(1) ; second instruction
      faddp  st(1), st
      fcomp  [esp+50h+var_3C]
      fnstsw ax
      test   ah, 41h
      jz     short loc_100040B7

```

The first FXCH instruction swaps ST(0) and ST(1), the second do the same, so both do nothing. This is a program uses MFC42.dll, so it could be MSVC 6.0, 5.0 or maybe even MSVC 4.2 from 1990s.

This pair do nothing, so it probably wasn't caught by MSVC compiler tests. Or maybe I wrong?

## 11.4.3 ftol2() in MSVC 2012

Just found this in ftol2() standard C/C++ library function (float-to-long conversion routine) in Microsoft Visual Studio 2012.

```

.text:00000036      public __ftol2
.text:00000036      __ftol2          proc near          ; CODE XREF: $$000000+7
.text:00000036                                     ; __ftol2_sse_excpt+7
.text:00000036          push     ebp
.text:00000037          mov     ebp, esp
.text:00000039          sub     esp, 20h
.text:0000003C          and     esp, 0FFFFFF0h
.text:0000003F          fld     st
.text:00000041          fst     dword ptr [esp+18h]
.text:00000045          fistp  qword ptr [esp+10h]
.text:00000049          fld     qword ptr [esp+10h]
.text:0000004D          mov     edx, [esp+18h]
.text:00000051          mov     eax, [esp+10h]
.text:00000055          test   eax, eax
.text:00000057          jz     short integer_QNaN_or_zero
.text:00000059
.text:00000059 arg_is_not_integer_QNaN:          ; CODE XREF: __ftol2+69
.text:00000059          fsubp  st(1), st
.text:0000005B          test   edx, edx
.text:0000005D          jns    short positive
.text:0000005F          fstp   dword ptr [esp]
.text:00000062          mov     ecx, [esp]
.text:00000065          xor     ecx, 80000000h
.text:0000006B          add     ecx, 7FFFFFFFh
.text:00000071          adc     eax, 0
.text:00000074          mov     edx, [esp+14h]
.text:00000078          adc     edx, 0
.text:0000007B          jmp    short localexit
.text:0000007D ; -----
.text:0000007D
.text:0000007D positive:          ; CODE XREF: __ftol2+27
.text:0000007D          fstp   dword ptr [esp]
.text:00000080          mov     ecx, [esp]
.text:00000083          add     ecx, 7FFFFFFFh
.text:00000089          sbb    eax, 0
.text:0000008C          mov     edx, [esp+14h]
.text:00000090          sbb    edx, 0
.text:00000093          jmp    short localexit
.text:00000095 ; -----
.text:00000095
.text:00000095 integer_QNaN_or_zero:          ; CODE XREF: __ftol2+21
.text:00000095          mov     edx, [esp+14h]
.text:00000099          test   edx, 7FFFFFFFh
.text:0000009F          jnz    short arg_is_not_integer_QNaN
.text:000000A1          fstp   dword ptr [esp+18h] ; first
.text:000000A5          fstp   dword ptr [esp+18h] ; second
.text:000000A9
.text:000000A9 localexit:          ; CODE XREF: __ftol2+45
.text:000000A9                                     ; __ftol2+5D
.text:000000A9          leave
.text:000000AA          retn
.text:000000AA      __ftol2          endp

```

Note two identical FSTP-s (float store with pop) at the end. First I thought it was compiler anomaly (I'm collecting such cases just as someone do with butterflies), but it seems, it's handwritten assembler piece, in msvcrt.lib there is an object file with this function in it, and we can find this string in it: f:\dd\vctools\crt\_bld\SELF\_X86\crt\prebuild\tran\i386\ftol2.asm — that was probably a path to the file on developer's computer where msvcrt.lib was built.

So, bug, text editor-induced typo, or feature?

#### 11.4.4 Summary

Other compiler anomalies here in this book: [1.28.2 on page 316](#), [3.10.3 on page 497](#), [3.18.7 on page 535](#), [1.26.7 on page 301](#), [1.18.4 on page 147](#), [1.28.5 on page 333](#).

Such cases are demonstrated here in this book, to show that such compilers errors are possible and

sometimes one should not rack one's brain while thinking why did the compiler generate such strange code.

## 11.5 Itanium

Although almost failed, Intel Itanium (IA64) is a very interesting architecture.

While OOE CPUs decides how to rearrange their instructions and execute them in parallel, EPIC<sup>2</sup> was an attempt to shift these decisions to the compiler: to let it group the instructions at the compile stage.

This resulted in notoriously complex compilers.

Here is one sample of IA64 code: simple cryptographic algorithm from the Linux kernel:

Listing 11.3: Linux kernel 3.2.0.4

```
#define TEA_ROUNDS          32
#define TEA_DELTA          0x9e3779b9

static void tea_encrypt(struct crypto_tfm *tfm, u8 *dst, const u8 *src)
{
    u32 y, z, n, sum = 0;
    u32 k0, k1, k2, k3;
    struct tea_ctx *ctx = crypto_tfm_ctx(tfm);
    const __le32 *in = (const __le32 *)src;
    __le32 *out = (__le32 *)dst;

    y = le32_to_cpu(in[0]);
    z = le32_to_cpu(in[1]);

    k0 = ctx->KEY[0];
    k1 = ctx->KEY[1];
    k2 = ctx->KEY[2];
    k3 = ctx->KEY[3];

    n = TEA_ROUNDS;

    while (n-- > 0) {
        sum += TEA_DELTA;
        y += ((z << 4) + k0) ^ (z + sum) ^ ((z >> 5) + k1);
        z += ((y << 4) + k2) ^ (y + sum) ^ ((y >> 5) + k3);
    }

    out[0] = cpu_to_le32(y);
    out[1] = cpu_to_le32(z);
}
```

Here is how it was compiled:

Listing 11.4: Linux Kernel 3.2.0.4 for Itanium 2 (McKinley)

```
0090|          tea_encrypt:
0090|08 80 80 41 00 21      adds r16 = 96, r32          // ptr to ctx->KEY[2]
0096|80 C0 82 00 42 00      adds r8 = 88, r32          // ptr to ctx->KEY[0]
009C|00 00 04 00           nop.i 0
00A0|09 18 70 41 00 21      adds r3 = 92, r32          // ptr to ctx->KEY[1]
00A6|F0 20 88 20 28 00      ld4 r15 = [r34], 4         // load z
00AC|44 06 01 84           adds r32 = 100, r32;;      // ptr to ctx->KEY[3]
00B0|08 98 00 20 10 10      ld4 r19 = [r16]           // r19=k2
00B6|00 01 00 00 42 40      mov r16 = r0              // r0 always contain zero
00BC|00 08 CA 00           mov.i r2 = ar.lc          // save lc register
00C0|05 70 00 44 10 10      ld4 r14 = [r34]           // load y
          9E FF FF FF 7F 20      ld4 r14 = [r34]           // load y
00CC|92 F3 CE 6B          movl r17 = 0xFFFFFFFF9E3779B9;; // TEA_DELTA
00D0|08 00 00 00 01 00      nop.m 0
00D6|50 01 20 20 20 00      ld4 r21 = [r8]            // r21=k0
00DC|F0 09 2A 00           mov.i ar.lc = 31          // TEA_ROUNDS is 32
00E0|0A A0 00 06 10 10      ld4 r20 = [r3];;         // r20=k1
00E6|20 01 80 20 20 00      ld4 r18 = [r32]          // r18=k3
```

<sup>2</sup>Explicitly Parallel Instruction Computing



```

00EC|00 00 04 00      nop.i 0
00F0|
00F0|                loc_F0:
00F0|09 80 40 22 00 20  add r16 = r16, r17      // r16=sum, r17=TEA_DELTA
00F6|D0 71 54 26 40 80  shladd r29 = r14, 4, r21 // r14=y, r21=k0
00FC|A3 70 68 52      extr.u r28 = r14, 5, 27;;
0100|03 F0 40 1C 00 20  add r30 = r16, r14
0106|B0 E1 50 00 40 40  add r27 = r28, r20;;    // r20=k1
010C|D3 F1 3C 80      xor r26 = r29, r30;;
0110|0B C8 6C 34 0F 20  xor r25 = r27, r26;;
0116|F0 78 64 00 40 00  add r15 = r15, r25     // r15=z
011C|00 00 04 00      nop.i 0;;
0120|00 00 00 00 01 00  nop.m 0
0126|80 51 3C 34 29 60  extr.u r24 = r15, 5, 27
012C|F1 98 4C 80      shladd r11 = r15, 4, r19 // r19=k2
0130|0B B8 3C 20 00 20  add r23 = r15, r16;;
0136|A0 C0 48 00 40 00  add r10 = r24, r18     // r18=k3
013C|00 00 04 00      nop.i 0;;
0140|0B 48 28 16 0F 20  xor r9 = r10, r11;;
0146|60 B9 24 1E 40 00  xor r22 = r23, r9
014C|00 00 04 00      nop.i 0;;
0150|11 00 00 00 01 00  nop.m 0
0156|E0 70 58 00 40 A0  add r14 = r14, r22
015C|A0 FF FF 48      br.cloop.sptk.few loc_F0;;
0160|09 20 3C 42 90 15  st4 [r33] = r15, 4    // store z
0166|00 00 00 02 00 00  nop.m 0
016C|20 08 AA 00      mov.i ar.lc = r2;;     // restore lc register
0170|11 00 38 42 90 11  st4 [r33] = r14     // store y
0176|00 00 00 02 00 80  nop.i 0
017C|08 00 84 00      br.ret.sptk.many b0;;

```

First of all, all [IA64](#) instructions are grouped into 3-instruction bundles.

Each bundle has a size of 16 bytes (128 bits) and consists of template code (5 bits) + 3 instructions (41 bits for each).

[IDA](#) shows the bundles as 6+6+4 bytes —you can easily spot the pattern.

All 3 instructions from each bundle usually executes simultaneously, unless one of instructions has a “stop bit”.

Supposedly, Intel and HP engineers gathered statistics on most frequent instruction patterns and decided to bring bundle types ([AKA](#) “templates”): a bundle code defines the instruction types in the bundle. There are 12 of them.

For example, the zeroth bundle type is MII, which implies the first instruction is Memory (load or store), the second and third ones are I (integer instructions).

Another example is the bundle of type 0x1d: MFB: the first instruction is Memory (load or store), the second one is Float ([FPU](#) instruction), and the third is Branch (branch instruction).

If the compiler cannot pick a suitable instruction for the relevant bundle slot, it may insert a [NOP](#): you can see here the `nop.i` instructions ([NOP](#) at the place where the integer instruction might be) or `nop.m` (a memory instruction might be at this slot).

[NOPs](#) are inserted automatically when one uses assembly language manually.

And that is not all. Bundles are also grouped.

Each bundle may have a “stop bit”, so all the consecutive bundles with a terminating bundle which has the “stop bit” can be executed simultaneously.

In practice, Itanium 2 can execute 2 bundles at once, resulting in the execution of 6 instructions at once.

So all instructions inside a bundle and a bundle group cannot interfere with each other (i.e., must not have data hazards).

If they do, the results are to be undefined.

Each stop bit is marked in assembly language as two semicolons (;;) after the instruction.

So, the instructions at [90-ac] may be executed simultaneously: they do not interfere. The next group is [b0-cc].

We also see a stop bit at 10c. The next instruction at 110 has a stop bit too.

This implies that these instructions must be executed isolated from all others (as in [CISC](#)).

Indeed: the next instruction at 110 uses the result from the previous one (the value in register r26), so they cannot be executed at the same time.

Apparently, the compiler was not able to find a better way to parallelize the instructions, in other words, to load [CPU](#) as much as possible, hence too much stop bits and [NOPs](#).

Manual assembly programming is a tedious job as well: the programmer has to group the instructions manually.

The programmer is still able to add stop bits to each instructions, but this will degrade the performance that Itanium was made for.

An interesting examples of manual [IA64](#) assembly code can be found in the Linux kernel's sources:

<http://go.yurichev.com/17322>.

Another introductory paper on Itanium assembly: [Mike Burrell, *Writing Efficient Itanium 2 Assembly Code* (2010)]<sup>3</sup>, [papasutra of haquebright, *WRITING SHELLCODE FOR IA-64* (2001)]<sup>4</sup>.

Another very interesting Itanium feature is the *speculative execution* and the NaT ("not a thing") bit, somewhat resembling [NaN](#) numbers:

[MSDN](#).

## 11.6 8086 memory model

When dealing with 16-bit programs for MS-DOS or Win16 ( [8.8.3 on page 846](#) or [3.34.5 on page 654](#)), we can see that the pointers consist of two 16-bit values. What do they mean? Oh yes, that is another weird MS-DOS and 8086 artifact.

8086/8088 was a 16-bit CPU, but was able to address 20-bit address in RAM (thus being able to access 1MB of external memory).

The external memory address space was divided between [RAM](#) (640KB max), [ROM](#), windows for video memory, EMS cards, etc.

Let's also recall that 8086/8088 was in fact an inheritor of the 8-bit 8080 CPU.

The 8080 has a 16-bit memory space, i.e., it was able to address only 64KB.

And probably because of reason of old software porting<sup>5</sup>, 8086 can support many 64KB windows simultaneously, placed within the 1MB address space.

This is some kind of a toy-level virtualization.

All 8086 registers are 16-bit, so to address more, special segment registers (CS, DS, ES, SS) were introduced.

Each 20-bit pointer is calculated using the values from a segment register and an address register pair (e.g. DS:BX) as follows:

$$real\_address = (segment\_register \ll 4) + address\_register$$

For example, the graphics ([EGA](#)<sup>6</sup>, [VGA](#)<sup>7</sup>) video [RAM](#) window on old IBM PC-compatibles has a size of 64KB.

To access it, a value of 0xA000 has to be stored in one of the segment registers, e.g. into DS.

Then DS:0 will address the first byte of video [RAM](#) and DS:0xFFFF — the last byte of RAM.

The real address on the 20-bit address bus, however, will range from 0xA0000 to 0xAFFFF.

The program may contain hard-coded addresses like 0x1234, but the [OS](#) may need to load the program at arbitrary addresses, so it recalculates the segment register values in a way that the program does not have to care where it's placed in the RAM.

So, any pointer in the old MS-DOS environment in fact consisted of the segment address and the address inside segment, i.e., two 16-bit values. 20-bit was enough for that, though, but we needed to recalculate

<sup>3</sup>Also available as <http://yurichev.com/mirrors/RE/itanium.pdf>

<sup>4</sup>Also available as <http://phrack.org/issues/57/5.html>

<sup>5</sup>The author is not 100% sure here

<sup>6</sup>Enhanced Graphics Adapter

<sup>7</sup>Video Graphics Array

the addresses very often: passing more information on the stack seemed a better space/convenience balance.

By the way, because of all this it was not possible to allocate a memory block larger than 64KB.

The segment registers were reused at 80286 as selectors, serving a different function.

When the 80386 CPU and computers with bigger RAM were introduced, MS-DOS was still popular, so the DOS extenders emerged: these were in fact a step toward a “serious” OS, switching the CPU in protected mode and providing much better memory APIs for the programs which still needed to run under MS-DOS.

Widely popular examples include DOS/4GW (the DOOM video game was compiled for it), Phar Lap, PMODE.

By the way, the same way of addressing memory was used in the 16-bit line of Windows 3.x, before Win32.

## 11.7 Basic blocks reordering

### 11.7.1 Profile-guided optimization

This optimization method can move some basic blocks to another section of the executable binary file.

Obviously, there are parts of a function which are executed more frequently (e.g., loop bodies) and less often (e.g., error reporting code, exception handlers).

The compiler adds instrumentation code into the executable, then the developer runs it with a lot of tests to collect statistics.

Then the compiler, with the help of the statistics gathered, prepares final the executable file with all infrequently executed code moved into another section.

As a result, all frequently executed function code is compacted, and that is very important for execution speed and cache usage.

An example from Oracle RDBMS code, which was compiled with Intel C++:

Listing 11.5: orageneric11.dll (win32)

```
public _skgfsync
_skgfsync    proc near
; address 0x6030D86A

        db      66h
        nop
        push   ebp
        mov    ebp, esp
        mov    edx, [ebp+0Ch]
        test   edx, edx
        jz    short loc_6030D884
        mov    eax, [edx+30h]
        test   eax, 400h
        jnz   __VInfreq__skgfsync ; write to log
continue:
        mov    eax, [ebp+8]
        mov    edx, [ebp+10h]
        mov    dword ptr [eax], 0
        lea   eax, [edx+0Fh]
        and   eax, 0FFFFFFFh
        mov    ecx, [eax]
        cmp   ecx, 45726963h
        jnz   error ; exit with error
        mov    esp, ebp
        pop   ebp
        retn
_skgfsync    endp

...

; address 0x60B953F0
__VInfreq__skgfsync:
        mov    eax, [edx]
```

```

    test    eax, eax
    jz     continue
    mov    ecx, [ebp+10h]
    push  ecx
    mov    ecx, [ebp+8]
    push  ecx
    push  edx
    push  ecx
    push  offset ... ; "skgfsync(se=0x%x, ctx=0x%x, iov=0x%x)\n"
    push  dword ptr [edx+4]
    call  dword ptr [eax] ; write to log
    add   esp, 14h
    jmp   continue

error:
    mov    edx, [ebp+8]
    mov    dword ptr [edx], 69AAh ; 27050 "function called with invalid FIB/IOV
structure"
    mov    eax, [eax]
    mov    [edx+4], eax
    mov    dword ptr [edx+8], 0FA4h ; 4004
    mov    esp, ebp
    pop   ebp
    retn
; END OF FUNCTION CHUNK FOR _skgfsync

```

The distance of addresses between these two code fragments is almost 9 MB.

All infrequently executed code was placed at the end of the code section of the DLL file, among all function parts.

This part of the function was marked by the Intel C++ compiler with the `VInfreq` prefix.

Here we see that a part of the function that writes to a log file (presumably in case of error or warning or something like that) which was probably not executed very often when Oracle's developers gathered statistics (if it was executed at all).

The writing to log basic block eventually returns the control flow to the "hot" part of the function.

Another "infrequent" part is the [basic block](#) returning error code 27050.

In Linux ELF files, all infrequently executed code is moved by Intel C++ into the separate `text.unlikely` section, leaving all "hot" code in the `text.hot` section.

From a reverse engineer's perspective, this information may help to split the function into its core and error handling parts.

## 11.8 My experience with Hex-Rays 2.2.0

### 11.8.1 Bugs

There are couple of bugs.

First of all, Hex-Rays is getting lost when `FPU` instructions are interleaved (by compiler codegenerator) with others.

For example, this:

```

f      proc    near

    lea    eax, [esp+4]
    fild  dword ptr [eax]
    lea    eax, [esp+8]
    fild  dword ptr [eax]
    fabs
    fcompp
    fnstsw ax
    test  ah, 1
    jz    l01

    mov    eax, 1

```

```

    retn
l01:
    mov     eax, 2
    retn
f
    endp

```

...will be correctly decompiled to:

```

signed int __cdecl f(signed int a1, signed int a2)
{
    signed int result; // eax@2

    if ( fabs((double)a2) >= (double)a1 )
        result = 2;
    else
        result = 1;
    return result;
}

```

But let's comment one of the instructions at the end:

```

...
l01:
    ;mov eax, 2
    retn
...

```

...we getting an obvious bug:

```

void __cdecl f(char a1, char a2)
{
    fabs((double)a2);
}

```

This is another bug:

```

extrn f1:dword
extrn f2:dword

f
    proc    near

        fld     dword ptr [esp+4]
        fadd   dword ptr [esp+8]
        fst     dword ptr [esp+12]
        fcomp  ds:const_100
        fld     dword ptr [esp+16] ; comment this instruction and it will be OK
        fnstsw ax
        test   ah, 1

        jnz    short l01

        call   f1
        retn

l01:
        call   f2
        retn

f
    endp

...

const_100    dd 42C80000h ; 100.0

```

Result:

```
int __cdecl f(float a1, float a2, float a3, float a4)
{
    double v5; // st7@1
    char v6; // c0@1
    int result; // eax@2

    v5 = a4;
    if ( v6 )
        result = f2(v5);
    else
        result = f1(v5);
    return result;
}
```

`v6` variable has `char` type and if you'll try to compile this code, compiler will warn you about variable usage before assignment.

Another bug: `FPATAN` instruction is correctly decompiled into `atan2()`, but arguments are swapped.

### 11.8.2 Odd peculiarities

Hex-Rays too often promotes 32-bit `int` to 64-bit one. Here is example:

```
f          proc    near

            mov     eax, [esp+4]
            cdq
            xor     eax, edx
            sub     eax, edx
            ; EAX=abs(a1)

            sub     eax, [esp+8]
            ; EAX=EAX-a2

            ; EAX at this point somehow gets promoted to 64-bit (RAX)

            cdq
            xor     eax, edx
            sub     eax, edx
            ; EAX=abs(abs(a1)-a2)

            retn

f          endp
```

Result:

```
int __cdecl f(int a1, int a2)
{
    __int64 v2; // rax@1

    v2 = abs(a1) - a2;
    return (HIDWORD(v2) ^ v2) - HIDWORD(v2);
}
```

Perhaps, this is result of `CDQ` instruction? I'm not sure. Anyway, whenever you see `__int64` type in 32-bit code, pay attention.

This is also weird:

```

f          proc    near

          mov     esi, [esp+4]

          lea   ebx, [esi+10h]
          cmp   esi, ebx
          jge   short l00

          cmp   esi, 1000
          jg    short l00

          mov   eax, 2
          retn

l00:
          mov   eax, 1
          retn

f          endp

```

Result:

```

signed int __cdecl f(signed int a1)
{
    signed int result; // eax@3

    if ( __OFSUB__(a1, a1 + 16) ^ 1 && a1 <= 1000 )
        result = 2;
    else
        result = 1;
    return result;
}

```

The code is correct, but needs manual intervention.

Sometimes, Hex-Rays doesn't fold (or reduce) division by multiplication code:

```

f          proc    near

          mov     eax, [esp+4]
          mov     edx, 2AAAAAABh
          imul   edx
          mov     eax, edx

          retn

f          endp

```

Result:

```

int __cdecl f(int a1)
{
    return (unsigned __int64)(715827883i64 * a1) >> 32;
}

```

This can be folded (rewritten) manually.

Many of these peculiarities can be solved by manual reordering of instructions, recompiling assembly code, and then feeding it to Hex-Rays again.

### 11.8.3 Silence

```

extrn some_func:dword

f                proc    near

                mov     ecx, [esp+4]
                mov     eax, [esp+8]
                push   eax
                call   some_func
                add     esp, 4

                ; use ECX
                mov     eax, ecx

                retn

f                endp

```

Result:

```

int __cdecl f(int a1, int a2)
{
    int v2; // ecx@1

    some_func(a2);
    return v2;
}

```

v2 variable (from ECX) is lost ...Yes, this code is incorrect (ECX value doesn't saved during call to another function), but it would be good for Hex-Rays to give a warning.

Another one:

```

extrn some_func:dword

f                proc    near

                call   some_func
                jnz    l01

                mov     eax, 1
                retn

l01:
                mov     eax, 2
                retn

f                endp

```

Result:

```

signed int f()
{
    char v0; // zf@1
    signed int result; // eax@2

    some_func();
    if ( v0 )
        result = 1;
    else
        result = 2;
    return result;
}

```

Again, warning would be great.



Anyway, whenever you see variable of *char* type, or variable which is used without initialization, this is clear sign that something went wrong and needs manual intervention.

### 11.8.4 Comma

Comma in C/C++ has a bad fame, because it can lead to a confusing code.

Quick quiz, what does this C/C++ function return?

```
int f()
{
    return 1, 2;
};
```

It's 2: when compiler encounters comma-expression, it generates code which executes all sub-expressions, and *returns* value of the last sub-expression.

I've seen something like that in production code:

```
if (cond)
    return global_var=123, 456; // 456 is returned
else
    return global_var=789, 321; // 321 is returned
```

Apparently, programmer wanted to make code slightly shorter without additional curly brackets. In other words, comma allows to pack couple of expressions into one, without forming statement/code block inside of curly brackets.

Comma in C/C++ is close to begin in Scheme/Racket: <https://docs.racket-lang.org/guide/begin.html>.

Perhaps, the only widely accepted usage of comma is in *for()* statements:

```
char *s="hello, world";
for(int i=0; *s; s++, i++);
// i = string length
```

Both *s++* and *i++* are executed at each loop iteration.

Read more: <https://stackoverflow.com/q/52550>.

I'm writing all this because Hex-Rays produces (at least in my case) code which is rich with both commas and short-circuit expressions. For example, this is real output from Hex-Rays:

```
if ( a >= b || (c = a, (d[a] - e) >> 2 > f) )
{
    ...
}
```

This is correct, it compiles and works, and let god help you to understand it. Here is it rewritten:

```
if (cond1 || (comma_expr, cond2))
{
    ...
}
```

Short-circuit is effective here: first *cond1* is checked, if it's *true*, *if()* body is executed, the rest of *if()* expression is ignored completely. If *cond1* is *false*, *comma\_expr* is executed (in the previous example, *a* gets copied to *c*), then *cond2* is checked. If *cond2* is *true*, *if()* body gets executed, or not. In other words, *if()* body gets executed if *cond1* is *true* or *cond2* is *true*, but if the latter is *true*, *comma\_expr* is also executed.

Now you can see why comma is so notorious.

**A word about short-circuit.** A common beginner's misconception is that sub-conditions are checked in some unspecified order, which is not true. In a `a | b | c` expression, `a`, `b` and `c` gets evaluated in unspecified order, so that is why `||` has also been added to C/C++, to apply short-circuit explicitly.

### 11.8.5 Data types

Data types is a problem for decompilers.

Hex-Rays can be blind to arrays in local stack, if they weren't set correctly before decompilation. Same story about global arrays.

Another problem is too big functions, where a single slot in local stack can be used by several variables across function's execution. It's not a rare case when a slot is used for *int*-variable, then for pointer, then for *float*-variable. Hex-Rays correctly decompiles it: it creates a variable with some type, then cast it to another type in various parts of functions. This problem has been solved by me by manual splitting big function into several smaller. Just make local variables as global ones, etc, etc. And don't forget about tests.

### 11.8.6 Long and messed expressions

Sometimes, during rewriting, you can end up with long and hard to understand expressions in *if()* constructs, like:

```
if ((!(v38 && v30 <= 5 && v27 != -1)) && ((!(v38 && v30 <= 5) && v27 != -1) || (v24 >= 5 || ↵
    ↵ v26)) && v25)
{
...
}
```

Wolfram Mathematica can minimize some of them, using `BooleanMinimize[]` function:

```
In[1]:= BooleanMinimize[!(v38 && v30 <= 5 && v27 != -1) && v38 && v30 <= 5 && v25 == 0]
Out[1]:= v38 && v25 == 0 && v27 == -1 && v30 <= 5
```

There is even better way, to find common subexpressions:

```
In[2]:= Experimental`OptimizeExpression[!(v38 && v30 <= 5 &&
    v27 != -1) && ((!(v38 && v30 <= 5) &&
    v27 != -1) || (v24 >= 5 || v26)) && v25]
Out[2]= Experimental`OptimizedExpression[
Block[{Compile`$1, Compile`$2}, Compile`$1 = v30 <= 5;
Compile`$2 =
    v27 != -1; ! (v38 && Compile`$1 &&
    Compile`$2) && ((!(v38 && Compile`$1) && Compile`$2) ||
    v24 >= 5 || v26) && v25]]
```

Mathematica has added two new variables: `Compile`$1` and `Compile`$2`, values of which are to be used several times in expression. So we can add two additional variables.

### 11.8.7 De Morgan's laws and decompilation

Sometimes a compiler's optimizer can use De Morgan's laws to make code shorter/faster.

For example, this:

```
void f(int a, int b, int c, int d)
{
    if (a>0 && b>0)
        printf ("both a and b are positive\n");
    else if (c>0 && d>0)
```

```

        printf ("both c and d are positive\n");
    else
        printf ("something else\n");
};

```

... looks pretty innocent, when compiled by optimizing GCC 5.4.0 x64:

```

; int __fastcall f(int a, int b, int c, int d)
f      public f
      proc near
      test    edi, edi
      jle    short loc_8
      test    esi, esi
      jg     short loc_30

loc_8:
      test    edx, edx
      jle    short loc_20
      test    ecx, ecx
      jle    short loc_20
      mov     edi, offset s ; "both c and d are positive"
      jmp    puts

loc_20:
      mov     edi, offset aSomethingElse ; "something else"
      jmp    puts

loc_30:
      mov     edi, offset aAAndBPositive ; "both a and b are positive"

loc_35:
      jmp    puts
f      endp

```

... also looks innocent, but Hex-Rays 2.2.0 cannot clearly see that both AND operations were actually used in the source code:

```

int __fastcall f(int a, int b, int c, int d)
{
    int result;

    if ( a > 0 && b > 0 )
    {
        result = puts("both a and b are positive");
    }
    else if ( c <= 0 || d <= 0 )
    {
        result = puts("something else");
    }
    else
    {
        result = puts("both c and d are positive");
    }
    return result;
}

```

The  $c \leq 0 \ || \ d \leq 0$  expression is inversion of  $c > 0 \ \&\& \ d > 0$  since  $\overline{A \cup B} = \overline{A} \cap \overline{B}$  and  $\overline{A \cap B} = \overline{A} \cup \overline{B}$ , in other words,  $!(cond1 \ || \ cond2) == !cond1 \ \&\& \ !cond2$  and  $!(cond1 \ \&\& \ cond2) == !cond1 \ || \ !cond2$ .

These rules are worth to be kept in mind, since this compiler optimization is used heavily almost everywhere.

Sometimes it's good idea to invert a condition, in order to understand a code better. This is a piece of a real code decompiled by Hex-Rays:

```

for (int i=0; i<12; i++)
{
    if (v1[i-12] != 0.0 || v1[i] != 0.0)
    {
        v108=min(v108, (float)v0[i*24 -2]);
        v113=max(v113, (float)v0[i*24]);
    };
}

```

... it can be rewritten like:

```

for (int i=0; i<12; i++)
{
    if (v1[i-12] == 0.0 && v1[i] == 0.0)
        continue;

    v108=min(v108, (float)v0[i*24 -2]);
    v113=max(v113, (float)v0[i*24]);
}

```

Which is better? I don't know yet, but for better understanding, it's great to take a look on both.

### 11.8.8 My plan

- Split big functions (and don't forget about tests). Sometimes it's very helpful to form new functions out of big loop bodies.
- Check/set data type of variables, arrays, etc.
- If you see odd result, *dangling* variable (which used before initialization), try to swap instructions manually, recompile it and feed to Hex-Rays again.

### 11.8.9 Summary

Nevertheless, quality of Hex-Rays 2.2.0 is very, very good. It makes life way easier.

## 11.9 Cyclomatic complexity

The term is used to measure complexity of a function. Complex functions are usually evil, because they are hard to maintain, hard to test, etc.

There are several heuristics to measure it.

For example, we can find in Linux kernel coding style<sup>8</sup>:

Now, some people will claim that having 8-character indentations makes the code move too far to the right, and makes it hard to read on a 80-character terminal screen. The answer to that is that if you need more than 3 levels of indentation, you're screwed anyway, and should fix your program.

...

Functions should be short and sweet, and do just one thing. They should fit on one or two screenfuls of text (the ISO/ANSI screen size is 80x24, as we all know), and do one thing and do that well.

The maximum length of a function is inversely proportional to the complexity and indentation level of that function. So, if you have a conceptually simple function that is just one long (but simple) case-statement, where you have to do lots of small things for a lot of different cases, it's OK to have a longer function.

However, if you have a complex function, and you suspect that a less-than-gifted first-year high-school student might not even understand what the function is all about, you

<sup>8</sup><https://www.kernel.org/doc/html/v4.10/process/coding-style.html>

should adhere to the maximum limits all the more closely. Use helper functions with descriptive names (you can ask the compiler to in-line them if you think it's performance-critical, and it will probably do a better job of it than you would have done).

Another measure of the function is the number of local variables. They shouldn't exceed 5-10, or you're doing something wrong. Re-think the function, and split it into smaller pieces. A human brain can generally easily keep track of about 7 different things, anything more and it gets confused. You know you're brilliant, but maybe you'd like to understand what you did 2 weeks from now.

In JPL Institutional Coding Standard for the C Programming Language <sup>9</sup>:

Functions should be no longer than 60 lines of text and define no more than 6 parameters. A function should not be longer than what can be printed on a single sheet of paper in a standard reference format with one line per statement and one line per declaration. Typically, this means no more than about 60 lines of code per function. Long lists of function parameters similarly compromise code clarity and should be avoided.

Each function should be a logical unit in the code that is understandable and verifiable as a unit. It is much harder to understand a logical unit that spans multiple screens on a computer display or multiple pages when printed. Excessively long functions are often a sign of poorly structured code.

Now let's back to cyclomatic complexity.

Without diving deep into graph theory: there are basic blocks and links between them. For example, this is how IDA shows BB<sup>10</sup>s and links (as arrows). Just click space and you'll see this: [1.18 on page 89](#). Each BB is also called vertex or node in graph theory. Each link - edge.

There are at least two popular ways to calculate cyclomatic complexity: 1) edges - nodes + 2 2) edges - nodes + number of exits (RET instructions)

As of IDA example below, there are 4 BBs, so that is 4 nodes. But there are also 4 links and 1 return instruction. By 1st rule, this is 2, by the second: 1.

The bigger the number, the more complex your function and things go from bad to worse. As you can see, additional exit (return instructions) make things even worse, as well as additional links between nodes (including additional goto's).

I wrote the simple IDAPython script (<https://beginners.re/current-tree/other/cyclomatic/cyclomatic.py>) to measure it. Here is result for Linux kernel 4.11 (most complex functions in it):

```
1829c0 do_check edges=937 nodes=574 rets=1 E-N+2=365 E-N+rets=364
2effe0 ext4_fill_super edges=862 nodes=568 rets=1 E-N+2=296 E-N+rets=295
5d92e0 wm5110_readable_register edges=661 nodes=369 rets=2 E-N+2=294 E-N+rets=294
277650 do_blockdev_direct_IO edges=771 nodes=507 rets=1 E-N+2=266 E-N+rets=265
10f7c0 load_module edges=711 nodes=465 rets=1 E-N+2=248 E-N+rets=247
787730 dev_ethtool edges=559 nodes=315 rets=1 E-N+2=246 E-N+rets=245
84e440 do_ipv6_setsockopt edges=468 nodes=237 rets=1 E-N+2=233 E-N+rets=232
72c3c0 mmc_init_card edges=593 nodes=365 rets=1 E-N+2=230 E-N+rets=229
...
```

( Full list: [https://beginners.re/current-tree/other/cyclomatic/linux\\_4.11\\_sorted.txt](https://beginners.re/current-tree/other/cyclomatic/linux_4.11_sorted.txt) )

This is source code of some of them: [do\\_check\(\)](#), [ext4\\_fill\\_super\(\)](#), [do\\_blockdev\\_direct\\_IO\(\)](#), [do\\_jit\(\)](#).

Most complex functions in Windows 7 ntoskrnl.exe file:

```
140569400 sub_140569400 edges=3070 nodes=1889 rets=1 E-N+2=1183 E-N+rets=1182
14007c640 MmAccessFault edges=2256 nodes=1424 rets=1 E-N+2=834 E-N+rets=833
1401a0410 FsRtlMdlReadCompleteDevEx edges=1241 nodes=752 rets=1 E-N+2=491 E-N+rets=490
14008c190 MmProbeAndLockPages edges=983 nodes=623 rets=1 E-N+2=362 E-N+rets=361
14037fd10 ExpQuerySystemInformation edges=995 nodes=671 rets=1 E-N+2=326 E-N+rets=325
140197260 MmProbeAndLockSelectedPages edges=875 nodes=551 rets=1 E-N+2=326 E-N+rets=325
```

<sup>9</sup>[https://yurichev.com/mirrors/C/JPL\\_Coding\\_Standard\\_C.pdf](https://yurichev.com/mirrors/C/JPL_Coding_Standard_C.pdf)

<sup>10</sup>Basic Block

```
140362a50 NtSetInformationProcess edges=880 nodes=586 rets=1 E-N+2=296 E-N+rets=295
....
```

( Full list: [https://beginners.re/current-tree/other/cyclomatic/win7\\_ntoskrnl\\_sorted.txt](https://beginners.re/current-tree/other/cyclomatic/win7_ntoskrnl_sorted.txt) )

From a bug hunter's standpoint, complex functions are prone to have bugs, so an attention should be paid to them.

Read more about it: [https://en.wikipedia.org/wiki/Cyclomatic\\_complexity](https://en.wikipedia.org/wiki/Cyclomatic_complexity), <http://wiki.c2.com/?CyclomaticComplexityMetric>.

Measuring cyclomatic complexity in MSVS (C#): <https://blogs.msdn.microsoft.com/zainnab/2011/05/17/code-metrics-cyclomatic-complexity/>.

Couple of other Python scripts for measuring cyclomatic complexity in IDA: [http://www.openrce.org/articles/full\\_view/11](http://www.openrce.org/articles/full_view/11), <https://github.com/mxmssh/IDAMetrics> (incl. other metrics).

GCC plugin: [https://github.com/ephox-gcc-plugins/cyclomatic\\_complexity](https://github.com/ephox-gcc-plugins/cyclomatic_complexity).

# Chapter 12

## Books/blogs worth reading

### 12.1 Books and other materials

#### 12.1.1 Reverse Engineering

- Eldad Eilam, *Reversing: Secrets of Reverse Engineering*, (2005)
- Bruce Dang, Alexandre Gazet, Elias Bachaalany, Sebastien Josse, *Practical Reverse Engineering: x86, x64, ARM, Windows Kernel, Reversing Tools, and Obfuscation*, (2014)
- Michael Sikorski, Andrew Honig, *Practical Malware Analysis: The Hands-On Guide to Dissecting Malicious Software*, (2012)
- Chris Eagle, *IDA Pro Book*, (2011)
- Reginald Wong, *Mastering Reverse Engineering: Re-engineer your ethical hacking skills*, (2018)

(Outdated, but still interesting) Pavol Cerven, *Crackproof Your Software: Protect Your Software Against Crackers*, (2002).

Also, Kris Kaspersky's books.

#### 12.1.2 Windows

- Mark Russinovich, *Microsoft Windows Internals*
- Peter Ferrie - The "Ultimate" Anti-Debugging Reference<sup>1</sup>

Blogs:

- [Microsoft: Raymond Chen](#)
- [nynaeve.net](#)

#### 12.1.3 C/C++

- Brian W. Kernighan, Dennis M. Ritchie, *The C Programming Language*, 2ed, (1988)
- *ISO/IEC 9899:TC3 (C C99 standard)*, (2007)<sup>2</sup>
- Bjarne Stroustrup, *The C++ Programming Language*, 4th Edition, (2013)
- C++11 standard<sup>3</sup>
- Agner Fog, *Optimizing software in C++* (2015)<sup>4</sup>
- Marshall Cline, *C++ FAQ*<sup>5</sup>
- Dennis Yurichev, *C/C++ programming language notes*<sup>6</sup>

<sup>1</sup><http://pferrie.host22.com/papers/antidebug.pdf>

<sup>2</sup>Also available as <http://go.yurichev.com/17274>

<sup>3</sup>Also available as <http://www.open-std.org/jtc1/sc22/wg21/docs/papers/2013/n3690.pdf>.

<sup>4</sup>Also available as [http://agner.org/optimize/optimizing\\_cpp.pdf](http://agner.org/optimize/optimizing_cpp.pdf).

<sup>5</sup>Also available as <http://go.yurichev.com/17291>

<sup>6</sup>Also available as <http://yurichev.com/C-book.html>

- JPL Institutional Coding Standard for the C Programming Language<sup>7</sup>

### 12.1.4 x86 / x86-64

- Intel manuals<sup>8</sup>
- AMD manuals<sup>9</sup>
- Agner Fog, *The microarchitecture of Intel, AMD and VIA CPUs*, (2016)<sup>10</sup>
- Agner Fog, *Calling conventions* (2015)<sup>11</sup>
- *Intel® 64 and IA-32 Architectures Optimization Reference Manual*, (2014)
- *Software Optimization Guide for AMD Family 16h Processors*, (2013)

Somewhat outdated, but still interesting to read:

Michael Abrash, *Graphics Programming Black Book*, 1997<sup>12</sup> (he is known for his work on low-level optimization for such projects as Windows NT 3.1 and id Quake).

### 12.1.5 ARM

- ARM manuals<sup>13</sup>
- *ARM(R) Architecture Reference Manual, ARMv7-A and ARMv7-R edition*, (2012)
- [*ARM Architecture Reference Manual, ARMv8, for ARMv8-A architecture profile*, (2013)]<sup>14</sup>
- Advanced RISC Machines Ltd, *The ARM Cookbook*, (1994)<sup>15</sup>

### 12.1.6 Assembly language

Richard Blum — Professional Assembly Language.

### 12.1.7 Java

[Tim Lindholm, Frank Yellin, Gilad Bracha, Alex Buckley, *The Java(R) Virtual Machine Specification / Java SE 7 Edition*] <sup>16</sup>.

### 12.1.8 UNIX

Eric S. Raymond, *The Art of UNIX Programming*, (2003)

### 12.1.9 Programming in general

- Brian W. Kernighan, Rob Pike, *Practice of Programming*, (1999)
- Henry S. Warren, *Hacker's Delight*, (2002). Some people say tricks and hacks from the book are not relevant today because they were good only for RISC CPUs, where branching instructions are expensive. Nevertheless, these can help immensely to understand boolean algebra and what all the mathematics near it.

<sup>7</sup>Also available as [https://yurichev.com/mirrors/C/JPL\\_Coding\\_Standard\\_C.pdf](https://yurichev.com/mirrors/C/JPL_Coding_Standard_C.pdf)

<sup>8</sup>Also available as <http://www.intel.com/content/www/us/en/processors/architectures-software-developer-manuals.html>

<sup>9</sup>Also available as <http://developer.amd.com/resources/developer-guides-manuals/>

<sup>10</sup>Also available as <http://agner.org/optimize/microarchitecture.pdf>

<sup>11</sup>Also available as [http://www.agner.org/optimize/calling\\_conventions.pdf](http://www.agner.org/optimize/calling_conventions.pdf)

<sup>12</sup>Also available as <https://github.com/jagregory/abrash-black-book>

<sup>13</sup>Also available as <http://infocenter.arm.com/help/index.jsp?topic=/com.arm.doc.subset.architecture.reference/index.html>

<sup>14</sup>Also available as [http://yurichev.com/mirrors/ARMv8-A\\_Architecture\\_Reference\\_Manual\\_\(Issue\\_A.a\).pdf](http://yurichev.com/mirrors/ARMv8-A_Architecture_Reference_Manual_(Issue_A.a).pdf)

<sup>15</sup>Also available as <http://go.yurichev.com/17273>

<sup>16</sup>Also available as <https://docs.oracle.com/javase/specs/jvms/se7/jvms7.pdf>; <http://docs.oracle.com/javase/specs/jvms/se7/html/>



### 12.1.10 Cryptography

- Bruce Schneier, *Applied Cryptography*, (John Wiley & Sons, 1994)
- (Free) Ivh, *Crypto 101*<sup>17</sup>
- (Free) Dan Boneh, Victor Shoup, *A Graduate Course in Applied Cryptography*<sup>18</sup>.

---

<sup>17</sup>Also available as <https://www.crypto101.io/>

<sup>18</sup>Also available as <https://crypto.stanford.edu/~dabo/cryptobook/>

# Chapter 13

## Communities

There are two excellent [RE](#)<sup>1</sup>-related subreddits on reddit.com: [reddit.com/r/ReverseEngineering/](https://reddit.com/r/ReverseEngineering/) and [reddit.com/r/remath](https://reddit.com/r/remath) (on the topics for the intersection of [RE](#) and mathematics).

There is also a [RE](#) part of the Stack Exchange website: [reverseengineering.stackexchange.com](https://reverseengineering.stackexchange.com).

On IRC there are [##re](#) and [##asm](#) channels on FreeNode<sup>2</sup>.

---

<sup>1</sup>Reverse Engineering

<sup>2</sup>[freenode.net](https://freenode.net)

# **Afterword**

## 13.1 Questions?

Do not hesitate to mail any questions to the author:

<first at last dot com> or <first dot last at gmail dot com>. Do you have any suggestion on new content for to the book? Please do not hesitate to send any corrections (including grammar (you see how horrible my English is?)), etc.

The author is working on the book a lot, so the page and listing numbers, etc., are changing very rapidly. Please do not refer to page and listing numbers in your emails to me. There is a much simpler method: make a screenshot of the page, in a graphics editor underline the place where you see the error, and send it to the author. He'll fix it much faster. And if you familiar with git and  $\text{\LaTeX}$  you can fix the error right in the source code:

[GitHub](#).

Do not worry to bother me while writing me about any petty mistakes you found, even if you are not very confident. I'm writing for beginners, after all, so beginners' opinions and comments are crucial for my job.

# **Appendix**

# .1 x86

## .1.1 Terminology

Common for 16-bit (8086/80286), 32-bit (80386, etc.), 64-bit.

**byte** 8-bit. The DB assembly directive is used for defining variables and arrays of bytes. Bytes are passed in the 8-bit part of registers: AL/BL/CL/DL/AH/BH/CH/DH/SIL/DIL/R\*L.

**word** 16-bit. DW assembly directive —"—. Words are passed in the 16-bit part of the registers: AX/BX/CX/DX/SI/DI/R\*W.

**double word** ("dword") 32-bit. DD assembly directive —"—. Double words are passed in registers (x86) or in the 32-bit part of registers (x64). In 16-bit code, double words are passed in 16-bit register pairs.

**quad word** ("qword") 64-bit. DQ assembly directive —"—. In 32-bit environment, quad words are passed in 32-bit register pairs.

**tbyte** (10 bytes) 80-bit or 10 bytes (used for IEEE 754 FPU registers).

**paragraph** (16 bytes)—term was popular in MS-DOS environment.

Data types of the same width (BYTE, WORD, DWORD) are also the same in Windows [API](#).

## .1.2 General purpose registers

It is possible to access many registers by byte or 16-bit word parts. .

It is all inheritance from older Intel CPUs (up to the 8-bit 8080) still supported for backward compatibility. Older 8-bit CPUs (8080) had 16-bit registers divided by two.

Programs written for 8080 could access the low byte part of 16-bit registers, high byte part or the whole 16-bit register.

Perhaps, this feature was left in 8086 as a helper for easier porting.

This feature is usually not present in [RISC](#) CPUs.

Registers prefixed with R- appeared in x86-64, and those prefixed with E—in 80386.

Thus, R-registers are 64-bit, and E-registers—32-bit.

8 more [GPR](#)'s were added in x86-86: R8-R15. .

N.B.: In the Intel manuals the byte parts of these registers are prefixed by *L*, e.g.: *R8L*, but [IDA](#) names these registers by adding the *B* suffix, e.g.: *R8B*.

### RAX/EAX/AX/AL

Byte number:							
7th	6th	5th	4th	3rd	2nd	1st	0th
RAX <sup>x64</sup>							
						EAX	
						AX	
						AH	AL

[AKA](#) accumulator. The result of a function is usually returned via this register.

### RBX/EBX/BX/BL

Byte number:							
7th	6th	5th	4th	3rd	2nd	1st	0th
RBX <sup>x64</sup>							
						EBX	
						BX	
						BH	BL

## RCX/ECX/CX/CL

Byte number:							
7th	6th	5th	4th	3rd	2nd	1st	0th
RCX <sup>x64</sup>							
						ECX	
						CX	
						CH	CL

AKA counter: in this role it is used in REP prefixed instructions and also in shift instructions (SHL/SHR/RxL/RxR).

## RDX/EDX/DX/DL

Byte number:							
7th	6th	5th	4th	3rd	2nd	1st	0th
RDX <sup>x64</sup>							
						EDX	
						DX	
						DH	DL

## RSI/ESI/SI/SIL

Byte number:							
7th	6th	5th	4th	3rd	2nd	1st	0th
RSI <sup>x64</sup>							
						ESI	
						SI	
						SIL <sup>x64</sup>	

AKA "source index". Used as source in the instructions REP MOV<sub>S</sub>x, REP CMPS<sub>x</sub>.

## RDI/EDI/DI/DIL

Byte number:							
7th	6th	5th	4th	3rd	2nd	1st	0th
RDI <sup>x64</sup>							
						EDI	
						DI	
						DIL <sup>x64</sup>	

AKA "destination index". Used as a pointer to the destination in the instructions REP MOV<sub>S</sub>x, REP STOS<sub>x</sub>.

## R8/R8D/R8W/R8L

Byte number:							
7th	6th	5th	4th	3rd	2nd	1st	0th
R8							
						R8D	
						R8W	
						R8L	

## R9/R9D/R9W/R9L

Byte number:							
7th	6th	5th	4th	3rd	2nd	1st	0th
R9							
						R9D	
						R9W	
						R9L	

**R10/R10D/R10W/R10L**

Byte number:							
7th	6th	5th	4th	3rd	2nd	1st	0th
R10							
				R10D			
						R10W	
							R10L

**R11/R11D/R11W/R11L**

Byte number:							
7th	6th	5th	4th	3rd	2nd	1st	0th
R11							
				R11D			
						R11W	
							R11L

**R12/R12D/R12W/R12L**

Byte number:							
7th	6th	5th	4th	3rd	2nd	1st	0th
R12							
				R12D			
						R12W	
							R12L

**R13/R13D/R13W/R13L**

Byte number:							
7th	6th	5th	4th	3rd	2nd	1st	0th
R13							
				R13D			
						R13W	
							R13L

**R14/R14D/R14W/R14L**

Byte number:							
7th	6th	5th	4th	3rd	2nd	1st	0th
R14							
				R14D			
						R14W	
							R14L

**R15/R15D/R15W/R15L**

Byte number:							
7th	6th	5th	4th	3rd	2nd	1st	0th
R15							
				R15D			
						R15W	
							R15L

**RSP/ESP/SP/SPL**

Byte number:							
7th	6th	5th	4th	3rd	2nd	1st	0th
RSP							
				ESP			
						SP	
							SPL

[AKA stack pointer](#). Usually points to the current stack except in those cases when it is not yet initialized.



## RBP/EBP/BP/BPL

Byte number:							
7th	6th	5th	4th	3rd	2nd	1st	0th
RBP							
				EBP			
						BP	
							BPL

[AKA](#) frame pointer. Usually used for local variables and accessing the arguments of the function. More about it: ( [1.12.1 on page 69](#)).

## RIP/EIP/IP

Byte number:							
7th	6th	5th	4th	3rd	2nd	1st	0th
RIP <sup>x64</sup>							
				EIP			
							IP

[AKA](#) “instruction pointer”<sup>3</sup>. Usually always points to the instruction to be executed right now. Cannot be modified, however, it is possible to do this (which is equivalent):

```
MOV EAX, ...
JMP EAX
```

Or:

```
PUSH value
RET
```

## CS/DS/ES/SS/FS/GS

16-bit registers containing code selector (CS), data selector (DS), stack selector (SS).

FS in win32 points to [TLS](#), GS took this role in Linux. It is made so for faster access to the [TLS](#) and other structures like the [TIB](#).

In the past, these registers were used as segment registers ( [11.6 on page 1000](#)).

## Flags register

[AKA](#) EFLAGS.

---

<sup>3</sup>Sometimes also called “program counter”

Bit (mask)	Abbreviation (meaning)	Description
0 (1)	CF (Carry)	The CLC/STC/CMC instructions are used for setting/resetting/toggling this flag
2 (4)	PF (Parity)	( <a href="#">1.25.7 on page 232</a> ).
4 (0x10)	AF (Adjust)	Exist solely for work with BCD-numbers
6 (0x40)	ZF (Zero)	Setting to 0 if the last operation's result is equal to 0.
7 (0x80)	SF (Sign)	
8 (0x100)	TF (Trap)	Used for debugging. If turned on, an exception is to be generated after each instruction's execution.
9 (0x200)	IF (Interrupt enable)	Are interrupts enabled. The CLI/STI instructions are used for setting/resetting the flag
10 (0x400)	DF (Direction)	A direction is set for the REP MOVSB/CMPSB/LODSB/SCASB instructions. The CLD/STD instructions are used for setting/resetting the flag See also: <a href="#">3.26 on page 629</a> .
11 (0x800)	OF (Overflow)	
12, 13 (0x3000)	IOPL (I/O privilege level) <sup>i286</sup>	
14 (0x4000)	NT (Nested task) <sup>i286</sup>	
16 (0x10000)	RF (Resume) <sup>i386</sup>	Used for debugging. The CPU ignores the hardware breakpoint in DRx if the flag is set.
17 (0x20000)	VM (Virtual 8086 mode) <sup>i386</sup>	
18 (0x40000)	AC (Alignment check) <sup>i486</sup>	
19 (0x80000)	VIF (Virtual interrupt) <sup>i586</sup>	
20 (0x100000)	VIP (Virtual interrupt pending) <sup>i586</sup>	
21 (0x200000)	ID (Identification) <sup>i586</sup>	

All the rest flags are reserved.

### .1.3 FPU registers

8 80-bit registers working as a stack: ST(0)-ST(7). N.B.: IDA calls ST(0) as just ST. Numbers are stored in the IEEE 754 format.

*long double* value format:



( S — sign, I — integer part )

#### Control Word

Register controlling the behavior of the FPU.

Bit	Abbreviation (meaning)	Description
0	IM (Invalid operation Mask)	
1	DM (Denormalized operand Mask)	
2	ZM (Zero divide Mask)	
3	OM (Overflow Mask)	
4	UM (Underflow Mask)	
5	PM (Precision Mask)	
7	IEM (Interrupt Enable Mask)	Exceptions enabling, 1 by default (disabled)
8, 9	PC (Precision Control)	00 — 24 bits (REAL4) 10 — 53 bits (REAL8) 11 — 64 bits (REAL10)
10, 11	RC (Rounding Control)	00 — (by default) round to nearest 01 — round toward $-\infty$ 10 — round toward $+\infty$ 11 — round toward 0
12	IC (Infinity Control)	0 — (by default) treat $+\infty$ and $-\infty$ as unsigned 1 — respect both $+\infty$ and $-\infty$

The PM, UM, OM, ZM, DM, IM flags define if to generate exception in the case of a corresponding error.

### Status Word

Read-only register.

Bit	Abbreviation (meaning)	Description
15	B (Busy)	Is FPU do something (1) or results are ready (0)
14	C3	
13, 12, 11	TOP	points to the currently zeroth register
10	C2	
9	C1	
8	C0	
7	IR (Interrupt Request)	
6	SF (Stack Fault)	
5	P (Precision)	
4	U (Underflow)	
3	O (Overflow)	
2	Z (Zero)	
1	D (Denormalized)	
0	I (Invalid operation)	

The SF, P, U, O, Z, D, I bits signal about exceptions.

About the C3, C2, C1, C0 you can read more here: ([1.25.7 on page 232](#)).

N.B.: When ST(x) is used, the FPU adds  $x$  to TOP (by modulo 8) and that is how it gets the internal register's number.

### Tag Word

The register has current information about the usage of numbers registers.

Bit	Abbreviation (meaning)
15, 14	Tag(7)
13, 12	Tag(6)
11, 10	Tag(5)
9, 8	Tag(4)
7, 6	Tag(3)
5, 4	Tag(2)
3, 2	Tag(1)
1, 0	Tag(0)

Each tag contains information about a physical FPU register (R(x)), not logical (ST(x)).

For each tag:

- 00 — The register contains a non-zero value

- 01 — The register contains 0
- 10 — The register contains a special value (NAN<sup>4</sup>, ∞, or denormal)
- 11 — The register is empty

## .1.4 SIMD registers

### MMX registers

8 64-bit registers: MM0..MM7.

### SSE and AVX registers

SSE: 8 128-bit registers: XMM0..XMM7. In the x86-64 8 more registers were added: XMM8..XMM15.

AVX is the extension of all these registers to 256 bits .

## .1.5 Debugging registers

Used for hardware breakpoints control.

- DR0 — address of breakpoint #1
- DR1 — address of breakpoint #2
- DR2 — address of breakpoint #3
- DR3 — address of breakpoint #4
- DR6 — a cause of break is reflected here
- DR7 — breakpoint types are set here

### DR6

Bit (mask)	Description
0 (1)	B0 — breakpoint #1 has been triggered
1 (2)	B1 — breakpoint #2 has been triggered
2 (4)	B2 — breakpoint #3 has been triggered
3 (8)	B3 — breakpoint #4 has been triggered
13 (0x2000)	BD — modification attempt of one of the DRx registers. may be raised if GD is enabled
14 (0x4000)	BS — single step breakpoint (TF flag has been set in EFLAGS). Highest priority. Other bits may also be set.
15 (0x8000)	BT (task switch flag)

N.B. A single step breakpoint is a breakpoint which occurs after each instruction. It can be enabled by setting TF in EFLAGS ( [.1.2 on page 1023](#)).

### DR7

Breakpoint types are set here.

---

<sup>4</sup>Not a Number

Bit (mask)	Description
0 (1)	L0 — enable breakpoint #1 for the current task
1 (2)	G0 — enable breakpoint #1 for all tasks
2 (4)	L1 — enable breakpoint #2 for the current task
3 (8)	G1 — enable breakpoint #2 for all tasks
4 (0x10)	L2 — enable breakpoint #3 for the current task
5 (0x20)	G2 — enable breakpoint #3 for all tasks
6 (0x40)	L3 — enable breakpoint #4 for the current task
7 (0x80)	G3 — enable breakpoint #4 for all tasks
8 (0x100)	LE — not supported since P6
9 (0x200)	GE — not supported since P6
13 (0x2000)	GD — exception is to be raised if any MOV instruction tries to modify one of the DRx registers
16,17 (0x30000)	breakpoint #1: R/W — type
18,19 (0xC0000)	breakpoint #1: LEN — length
20,21 (0x300000)	breakpoint #2: R/W — type
22,23 (0xC00000)	breakpoint #2: LEN — length
24,25 (0x3000000)	breakpoint #3: R/W — type
26,27 (0xC000000)	breakpoint #3: LEN — length
28,29 (0x30000000)	breakpoint #4: R/W — type
30,31 (0xC0000000)	breakpoint #4: LEN — length

The breakpoint type is to be set as follows (R/W):

- 00 — instruction execution
- 01 — data writes
- 10 — I/O reads or writes (not available in user-mode)
- 11 — on data reads or writes

N.B.: breakpoint type for data reads is absent, indeed.

Breakpoint length is to be set as follows (LEN):

- 00 — one-byte
- 01 — two-byte
- 10 — undefined for 32-bit mode, eight-byte in 64-bit mode
- 11 — four-byte

## .1.6 Instructions

Instructions marked as (M) are not usually generated by the compiler: if you see one of them, it is probably a hand-written piece of assembly code, or a compiler intrinsic ( [11.3 on page 995](#)).

Only the most frequently used instructions are listed here. You can read [12.1.4 on page 1014](#) for a full documentation.

Do you have to know all instruction's opcodes by heart? No, only those which are used for code patching ( [11.1.1 on page 994](#)). All the rest of the opcodes don't need to be memorized.

### Prefixes

**LOCK** forces CPU to make exclusive access to the RAM in multiprocessor environment. For the sake of simplification, it can be said that when an instruction with this prefix is executed, all other CPUs in a multiprocessor system are stopped. Most often it is used for critical sections, semaphores, mutexes. Commonly used with ADD, AND, BTR, BTS, CMPXCHG, OR, XADD, XOR. You can read more about critical sections here ( [6.5.4 on page 789](#)).

**REP** is used with the MOVsx and STOSx instructions: execute the instruction in a loop, the counter is located in the CX/ECX/RCX register. For a detailed description, read more about the MOVsx ( [.1.6 on page 1030](#)) and STOSx ( [.1.6 on page 1032](#)) instructions.

The instructions prefixed by REP are sensitive to the DF flag, which is used to set the direction.

**REPE/REPNE** (AKA REPZ/REPNZ) used with CMPSx and SCASx instructions: execute the last instruction in a loop, the count is set in the CX/ECX/RCX register. It terminates prematurely if ZF is 0 (REPE) or if ZF is 1 (REPNE).

For a detailed description, you can read more about the CMPSx ([.1.6 on page 1033](#)) and SCASx ([.1.6 on page 1031](#)) instructions.

Instructions prefixed by REPE/REPNE are sensitive to the DF flag, which is used to set the direction.

## Most frequently used instructions

These can be memorized in the first place.

**ADC** (*add with carry*) add values, [increment](#) the result if the CF flag is set. ADC is often used for the addition of large values, for example, to add two 64-bit values in a 32-bit environment using two ADD and ADC instructions. For example:

```
; work with 64-bit values: add val1 to val2.
; .lo means lowest 32 bits, .hi means highest.
ADD val1.lo, val2.lo
ADC val1.hi, val2.hi ; use CF that was set or cleared at the previous instruction
```

One more example: [1.34 on page 395](#).

**ADD** add two values

**AND** logical “and”

**CALL** call another function:

```
PUSH address_after_CALL_instruction; JMP label
```

**CMP** compare values and set flags, the same as SUB but without writing the result

**DEC** [decrement](#). Unlike other arithmetic instructions, DEC doesn’t modify CF flag.

**IMUL** signed multiply IMUL often used instead of MUL, read more about it: [2.2.1 on page 454](#).

**INC** [increment](#). Unlike other arithmetic instructions, INC doesn’t modify CF flag.

**JCXZ, JECXZ, JRCXZ** (M) jump if CX/ECX/RCX=0

**JMP** jump to another address. The opcode has a [jump offset](#).

**Jcc** (where cc — condition code)

A lot of these instructions have synonyms (denoted with AKA), this was done for convenience. Synonymous instructions are translated into the same opcode. The opcode has a [jump offset](#).

**JAE** [AKA](#) JNC: jump if above or equal (unsigned): CF=0

**JA** [AKA](#) JNBE: jump if greater (unsigned): CF=0 and ZF=0

**JBE** jump if lesser or equal (unsigned): CF=1 or ZF=1

**JB** [AKA](#) JC: jump if below (unsigned): CF=1

**JC** [AKA](#) JB: jump if CF=1

**JE** [AKA](#) JZ: jump if equal or zero: ZF=1

**JGE** jump if greater or equal (signed): SF=OF

**JG** jump if greater (signed): ZF=0 and SF=OF

**JLE** jump if lesser or equal (signed): ZF=1 or SF≠OF

**JL** jump if lesser (signed): SF≠OF

**JNAE** [AKA](#) JC: jump if not above or equal (unsigned) CF=1

**JNA** jump if not above (unsigned) CF=1 and ZF=1

**JNBE** jump if not below or equal (unsigned): CF=0 and ZF=0

**JNB** [AKA](#) JNC: jump if not below (unsigned): CF=0

**JNC** [AKA](#) JAE: jump CF=0 synonymous to JNB.

**JNE** [AKA](#) JNZ: jump if not equal or not zero: ZF=0

**JNGE** jump if not greater or equal (signed): SF≠OF  
**JNG** jump if not greater (signed): ZF=1 or SF≠OF  
**JNLE** jump if not lesser (signed): ZF=0 and SF=OF  
**JNL** jump if not lesser (signed): SF=OF  
**JNO** jump if not overflow: OF=0  
**JNS** jump if SF flag is cleared  
**JNZ** *AKA* JNE: jump if not equal or not zero: ZF=0  
**JO** jump if overflow: OF=1  
**JPO** jump if PF flag is cleared (Jump Parity Odd)  
**JP** *AKA* JPE: jump if PF flag is set  
**JS** jump if SF flag is set  
**JZ** *AKA* JE: jump if equal or zero: ZF=1

**LAHF** copy some flag bits to AH:

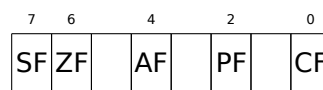

This instruction is often used in [FPU](#)-related code.

**LEAVE** equivalent of the MOV ESP, EBP and POP EBP instruction pair — in other words, this instruction sets the [stack pointer](#) (ESP) back and restores the EBP register to its initial state.

**LEA** (*Load Effective Address*) form an address

This instruction was intended not for summing values and multiplication but for forming an address, e.g., for calculating the address of an array element by adding the array address, element index, with multiplication of element size<sup>5</sup>.

So, the difference between MOV and LEA is that MOV forms a memory address and loads a value from memory or stores it there, but LEA just forms an address.

But nevertheless, it is can be used for any other calculations.

LEA is convenient because the computations performed by it does not alter [CPU](#) flags. This may be very important for [OOE](#) processors (to create less data dependencies).

Aside from this, starting at least at Pentium, LEA instruction is executed in 1 cycle.

```
int f(int a, int b)
{
    return a*8+b;
};
```

Listing 1: Optimizing MSVC 2010

```
_a$ = 8      ; size = 4
_b$ = 12     ; size = 4
_f          PROC
    mov     eax, DWORD PTR _b$[esp-4]
    mov     ecx, DWORD PTR _a$[esp-4]
    lea    eax, DWORD PTR [eax+ecx*8]
    ret     0
_f          ENDP
```

Intel C++ uses LEA even more:

<sup>5</sup>See also: [wikipedia](#)

```
int f1(int a)
{
    return a*13;
};
```

Listing 2: Intel C++ 2011

```
_f1 PROC NEAR
mov     ecx, DWORD PTR [4+esp]      ; ecx = a
lea     edx, DWORD PTR [ecx+ecx*8]  ; edx = a*9
lea     eax, DWORD PTR [edx+ecx*4]  ; eax = a*9 + a*4 = a*13
ret
```

These two instructions performs faster than one IMUL.

**MOVSB/MOVSW/MOVSD/MOVSQ** copy byte/ 16-bit word/ 32-bit word/ 64-bit word from the address which is in SI/ESI/RSI into the address which is in DI/EDI/RDI.

Together with the REP prefix, it is to be repeated in a loop, the count is to be stored in the CX/ECX/RCX register: it works like memcpy() in C. If the block size is known to the compiler in the compile stage, memcpy() is often inlined into a short code fragment using REP MOVSt, sometimes even as several instructions.

The memcpy(EDI, ESI, 15) equivalent is:

```
; copy 15 bytes from ESI to EDI
CLD      ; set direction to forward
MOV ECX, 3
REP MOVSD ; copy 12 bytes
MOVSW    ; copy 2 more bytes
MOVSB    ; copy remaining byte
```

( Supposedly, it works faster than copying 15 bytes using just one REP MOVSB).

**MOVSX** load with sign extension see also: ( [1.23.1 on page 201](#))

**MOVZX** load and clear all other bits see also: ( [1.23.1 on page 202](#))

**MOV** load value. this instruction name is misnomer, resulting in some confusion (data is not moved but copied), in other architectures the same instructions is usually named "LOAD" and/or "STORE" or something like that.

One important thing: if you set the low 16-bit part of a 32-bit register in 32-bit mode, the high 16 bits remains as they were. But if you modify the low 32-bit part of the register in 64-bit mode, the high 32 bits of the register will be cleared.

Supposedly, it was done to simplify porting code to x86-64.

**MUL** unsigned multiply. IMUL often used instead of MUL, read more about it: [2.2.1 on page 454](#).

**NEG** negation:  $op = -op$  Same as NOT op / ADD op, 1.

**NOP** **NOP**. Its opcode is 0x90, it is in fact the XCHG EAX, EAX idle instruction. This implies that x86 does not have a dedicated **NOP** instruction (as in many **RISC**). This book has at least one listing where GDB shows NOP as 16-bit XCHG instruction: [1.11.1 on page 49](#).

More examples of such operations: ( [.1.7 on page 1039](#)).

**NOP** may be generated by the compiler for aligning labels on a 16-byte boundary. Another very popular usage of **NOP** is to replace manually (patch) some instruction like a conditional jump to **NOP** in order to disable its execution.

**NOT** op1:  $op1 = \neg op1$ . logical inversion Important feature—the instruction doesn't change flags.

**OR** logical "or"

**POP** get a value from the stack: value=SS:[ESP]; ESP=ESP+4 (or 8)

**PUSH** push a value into the stack: ESP=ESP-4 (or 8); SS:[ESP]=value



**RET** return from subroutine: POP tmp; JMP tmp.

In fact, RET is an assembly language macro, in Windows and \*NIX environment it is translated into RETN (“return near”) or, in MS-DOS times, where the memory was addressed differently ( 11.6 on page 1000), into RETF (“return far”).

RET can have an operand. Then it works like this:

POP tmp; ADD ESP op1; JMP tmp. RET with an operand usually ends functions in the *stdcall* calling convention, see also: 6.1.2 on page 735.

**SAHF** copy bits from AH to CPU flags:

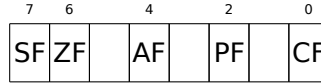

This instruction is often used in FPU-related code.

**SBB** (*subtraction with borrow*) subtract values, **decrement** the result if the CF flag is set. SBB is often used for subtraction of large values, for example, to subtract two 64-bit values in 32-bit environment using two SUB and SBB instructions. For example:

```

; work with 64-bit values: subtract val2 from val1.
; .lo means lowest 32 bits, .hi means highest.
SUB val1.lo, val2.lo
SBB val1.hi, val2.hi ; use CF that was set or cleared at the previous instruction

```

One more example: 1.34 on page 395.

**SCASB/SCASW/SCASD/SCASQ** (M) compare byte/ 16-bit word/ 32-bit word/ 64-bit word that’s stored in AX/EAX/RAX with a variable whose address is in DI/EDI/RDI. Set flags as CMP does.

This instruction is often used with the REPNE prefix: continue to scan the buffer until a special value stored in AX/EAX/RAX is found. Hence “NE” in REPNE: continue to scan while the compared values are not equal and stop when equal.

It is often used like the strlen() C standard function, to determine an ASCII string’s length:

Example:

```

lea    edi, string
mov    ecx, 0FFFFFFFFh ; scan 232-1 bytes, i.e., almost infinitely
xor    eax, eax        ; 0 is the terminator
repne scasb
add    edi, 0FFFFFFFFh ; correct it

; now EDI points to the last character of the ASCII string.

; lets determine string length
; current ECX = -1-strlen

not    ecx
dec    ecx

; now ECX contain string length

```

If we use a different AX/EAX/RAX value, the function acts like the memchr() standard C function, i.e., it finds a specific byte.

**SHL** shift value left

**SHR** shift value right:

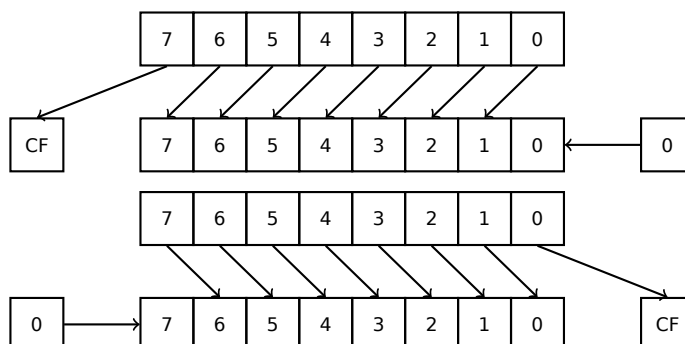

These instructions are frequently used for multiplication and division by  $2^n$ . Another very frequent application is processing bit fields: [1.28 on page 305](#).

**SHRD** op1, op2, op3: shift value in op2 right by op3 bits, taking bits from op1.

Example: [1.34 on page 395](#).

**STOSB/STOSW/STOSD/STOSQ** store byte/ 16-bit word/ 32-bit word/ 64-bit word from AX/EAX/RAX into the address which is in DI/EDI/RDI.

Together with the REP prefix, it is to be repeated in a loop, the counter is in the CX/ECX/RCX register: it works like memset() in C. If the block size is known to the compiler on compile stage, memset() is often inlined into a short code fragment using REP MOVSB, sometimes even as several instructions.

memset(EDI, 0xAA, 15) equivalent is:

```
; store 15 0xAA bytes to EDI
CLD                ; set direction to forward
MOV EAX, 0AAAAAAAh
MOV ECX, 3
REP STOSD          ; write 12 bytes
STOSW              ; write 2 more bytes
STOSB              ; write remaining byte
```

( Supposedly, it works faster than storing 15 bytes using just one REP STOSB).

**SUB** subtract values. A frequently occurring pattern is SUB reg, reg, which implies zeroing of reg.

**TEST** same as AND but without saving the result, see also: [1.28 on page 305](#)

**XOR** op1, op2: XOR<sup>6</sup> values.  $op1 = op1 \oplus op2$ . A frequently occurring pattern is XOR reg, reg, which implies zeroing of reg. See also: [2.6 on page 461](#).

### Less frequently used instructions

**BSF** bit scan forward, see also: [1.36.2 on page 420](#)

**BSR** bit scan reverse

**BSWAP** (byte swap), change value [endianness](#).

**BTC** bit test and complement

**BTR** bit test and reset

**BTS** bit test and set

**BT** bit test

**CBW/CWD/CWDE/CDQ/CDQE** Sign-extend value:

**CBW** convert byte in AL to word in AX

**CWD** convert word in AX to doubleword in DX:AX

**CWDE** convert word in AX to doubleword in EAX

**CDQ** convert doubleword in EAX to quadword in EDX:EAX

**CDQE** (x64) convert doubleword in EAX to quadword in RAX

These instructions consider the value's sign, extending it to high part of the newly constructed value. See also: [1.34.5 on page 404](#).

Interestingly to know these instructions was initially named as SEX (*Sign EXtend*), as Stephen P. Morse (one of Intel 8086 CPU designers) wrote in [Stephen P. Morse, *The 8086 Primer*, (1980)]<sup>7</sup>:

The process of stretching numbers by extending the sign bit is called sign extension. The 8086 provides instructions (Fig. 3.29) to facilitate the task of sign extension. These instructions were initially named SEX (sign extend) but were later renamed to the more conservative CBW (convert byte to word) and CWD (convert word to double word).

**CLD** clear DF flag.

<sup>6</sup>eXclusive OR

<sup>7</sup>Also available as <https://archive.org/details/The8086Primer>

**CLI** (M) clear IF flag.

**CMC** (M) toggle CF flag

**CMOVcc** conditional MOV: load if the condition is true. The condition codes are the same as in the Jcc instructions ( [.1.6 on page 1028](#)).

**CMPSB/CMPSW/CMPSD/CMPSQ** (M) compare byte/ 16-bit word/ 32-bit word/ 64-bit word from the address which is in SI/ESI/RSI with the variable at the address stored in DI/EDI/RDI. Set flags as CMP does.

Together with the REP prefix, it is to be repeated in a loop, the counter is stored in the CX/ECX/RCX register, the process will run until the ZF flag is zero (e.g., until the compared values are equal to each other, hence “E” in REPE).

It works like memcmp() in C.

Example from the Windows NT kernel ([WRK v1.2](#)):

Listing 3: base\ntos\rtl\i386\movemem.asm

```
; ULONG
; RtlCompareMemory (
; IN PVOID Source1,
; IN PVOID Source2,
; IN ULONG Length
; )
;
; Routine Description:
;
; This function compares two blocks of memory and returns the number
; of bytes that compared equal.
;
; Arguments:
;
; Source1 (esp+4) - Supplies a pointer to the first block of memory to
; compare.
;
; Source2 (esp+8) - Supplies a pointer to the second block of memory to
; compare.
;
; Length (esp+12) - Supplies the Length, in bytes, of the memory to be
; compared.
;
; Return Value:
;
; The number of bytes that compared equal is returned as the function
; value. If all bytes compared equal, then the length of the original
; block of memory is returned.
;
;--

RcmSource1    equ    [esp+12]
RcmSource2    equ    [esp+16]
RcmLength     equ    [esp+20]

CODE_ALIGNMENT
cPublicProc _RtlCompareMemory,3
cPublicFpo 3,0

        push    esi                ; save registers
        push    edi                ;
        cld                        ; clear direction
        mov     esi,RcmSource1     ; (esi) -> first block to compare
        mov     edi,RcmSource2     ; (edi) -> second block to compare

;
; Compare dwords, if any.
;

rcm10:    mov     ecx,RcmLength     ; (ecx) = length in bytes
        shr     ecx,2              ; (ecx) = length in dwords
```

```

        jz      rcm20                ; no dwords, try bytes
        repe   cmpsd                ; compare dwords
        jnz    rcm40                ; mismatch, go find byte
;
; Compare residual bytes, if any.
;
rcm20:  mov     ecx,RcmLength        ; (ecx) = length in bytes
        and     ecx,3                ; (ecx) = length mod 4
        jz      rcm30                ; 0 odd bytes, go do dwords
        repe   cmpsb                ; compare odd bytes
        jnz    rcm50                ; mismatch, go report how far we got
;
; All bytes in the block match.
;
rcm30:  mov     eax,RcmLength        ; set number of matching bytes
        pop     edi                  ; restore registers
        pop     esi                  ;
        stdRET  _RtlCompareMemory
;
; When we come to rcm40, esi (and edi) points to the dword after the
; one which caused the mismatch. Back up 1 dword and find the byte.
; Since we know the dword didn't match, we can assume one byte won't.
;
rcm40:  sub     esi,4                ; back up
        sub     edi,4                ; back up
        mov     ecx,5                ; ensure that ecx doesn't count out
        repe   cmpsb                ; find mismatch byte
;
; When we come to rcm50, esi points to the byte after the one that
; did not match, which is TWO after the last byte that did match.
;
rcm50:  dec     esi                  ; back up
        sub     esi,RcmSource1       ; compute bytes that matched
        mov     eax,esi              ;
        pop     edi                  ; restore registers
        pop     esi                  ;
        stdRET  _RtlCompareMemory
stdENDP _RtlCompareMemory

```

N.B.: this function uses a 32-bit word comparison (CMPSD) if the block size is a multiple of 4, or per-byte comparison (CMPSB) otherwise.

**CPUID** get information about the CPU's features. see also: ( [1.30.6 on page 369](#)).

**DIV** unsigned division

**IDIV** signed division

**INT** (M): INT x is analogous to PUSHF; CALL dword ptr [x\*4] in 16-bit environment. It was widely used in MS-DOS, functioning as a syscall vector. The registers AX/BX/CX/DX/SI/DI were filled with the arguments and then the flow jumped to the address in the Interrupt Vector Table (located at the beginning of the address space). It was popular because INT has a short opcode (2 bytes) and the program which needs some MS-DOS services is not bother to determine the address of the service's entry point. The interrupt handler returns the control flow to caller using the IRET instruction.

The most busy MS-DOS interrupt number was 0x21, serving a huge part of its [API](#). See also: [Ralf Brown *Ralf Brown's Interrupt List*], for the most comprehensive interrupt lists and other MS-DOS information.

In the post-MS-DOS era, this instruction was still used as syscall both in Linux and Windows ( [6.3 on page 749](#)), but was later replaced by the SYSENTER or SYSCALL instructions.

**INT 3 (M):** this instruction is somewhat close to INT, it has its own 1-byte opcode (0xCC), and is actively used while debugging. Often, the debuggers just write the 0xCC byte at the address of the breakpoint to be set, and when an exception is raised, the original byte is restored and the original instruction at this address is re-executed.

As of [Windows NT](#), an EXCEPTION\_BREAKPOINT exception is to be raised when the CPU executes this instruction. This debugging event may be intercepted and handled by a host debugger, if one is loaded. If it is not loaded, Windows offers to run one of the registered system debuggers. If [MSVS<sup>8</sup>](#) is installed, its debugger may be loaded and connected to the process. In order to protect from [reverse engineering](#), a lot of anti-debugging methods check integrity of the loaded code.

MSVC has [compiler intrinsic](#) for the instruction: `__debugbreak()`<sup>9</sup>.

There is also a win32 function in kernel32.dll named `DebugBreak()`<sup>10</sup>, which also executes INT 3.

**IN (M)** input data from port. The instruction usually can be seen in OS drivers or in old MS-DOS code, for example ( [8.8.3 on page 846](#)).

**IRET :** was used in the MS-DOS environment for returning from an interrupt handler after it was called by the INT instruction. Equivalent to `POP tmp; POPF; JMP tmp`.

**LOOP (M)** [decrement](#) CX/ECX/RCX, jump if it is still not zero.

LOOP instruction was often used in DOS-code which works with external devices. To add small delay, this was done:

```

MOV     CX, nnnn
LABEL: LOOP LABEL

```

Drawback is obvious: length of delay depends on CPU speed.

**OUT (M)** output data to port. The instruction usually can be seen in OS drivers or in old MS-DOS code, for example ( [8.8.3 on page 846](#)).

**POPA (M)** restores values of (R|E)DI, (R|E)SI, (R|E)BP, (R|E)BX, (R|E)DX, (R|E)CX, (R|E)AX registers from the stack.

**POPCNT** population count. Counts the number of 1 bits in the value.

See: [2.7 on page 464](#).

**POPF** restore flags from the stack ([AKA](#) EFLAGS register)

**PUSHA (M)** pushes the values of the (R|E)AX, (R|E)CX, (R|E)DX, (R|E)BX, (R|E)BP, (R|E)SI, (R|E)DI registers to the stack.

**PUSHF** push flags ([AKA](#) EFLAGS register)

**RCL (M)** rotate left via CF flag:

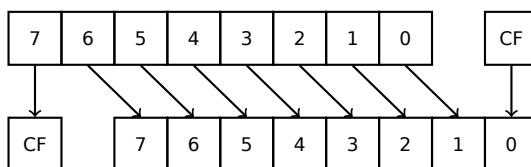

**RCR (M)** rotate right via CF flag:

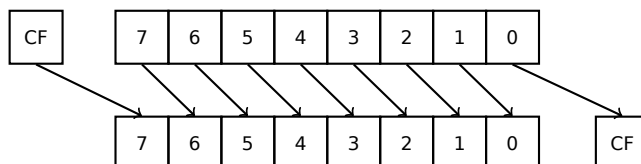

**ROL/ROR (M)** cyclic shift

ROL: rotate left:

<sup>8</sup>Microsoft Visual Studio

<sup>9</sup>MSDN

<sup>10</sup>MSDN

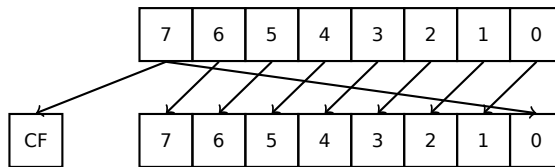

ROR: rotate right:

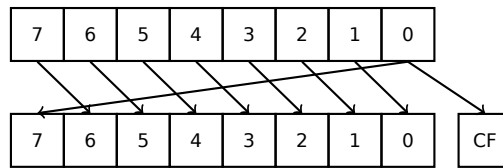

Despite the fact that almost all CPUs have these instructions, there are no corresponding operations in C/C++, so the compilers of these PLs usually do not generate these instructions.

For the programmer's convenience, at least MSVC has the pseudofunctions (compiler intrinsics) `_rotl()` and `_rotr()`<sup>11</sup>, which are translated by the compiler directly to these instructions.

**SAL** Arithmetic shift left, synonymous to SHL

**SAR** Arithmetic shift right

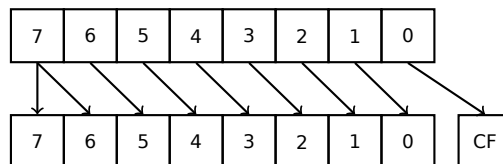

Hence, the sign bit always stays at the place of the MSB.

**SETcc** op: load 1 to operand (byte only) if the condition is true or zero otherwise. The condition codes are the same as in the Jcc instructions ( .1.6 on page 1028).

**STC** (M) set CF flag

**STD** (M) set DF flag. This instruction is not generated by compilers and generally rare. For example, it can be found in the `ntoskrnl.exe` Windows kernel file, in the hand-written memory copy routines.

**STI** (M) set IF flag

**SYSCALL** (AMD) call syscall ( 6.3 on page 749)

**SYSENTER** (Intel) call syscall ( 6.3 on page 749)

**UD2** (M) undefined instruction, raises exception. Used for testing.

**XCHG** (M) exchange the values in the operands

This instruction is rare: compilers don't generate it, because starting at Pentium, XCHG with address in memory in operand executes as if it has LOCK prefix ([Michael Abrash, *Graphics Programming Black Book*, 1997chapter 19]). Perhaps, Intel engineers did so for compatibility with synchronizing primitives. Hence, XCHG starting at Pentium can be slow. On the other hand, XCHG was very popular in assembly language programmers. So if you see XCHG in code, it can be a sign that this piece of code is written manually. However, at least Borland Delphi compiler generates this instruction.

## FPU instructions

-R suffix in the mnemonic usually implies that the operands are reversed, -P suffix implies that one element is popped from the stack after the instruction's execution, -PP suffix implies that two elements are popped.

-P instructions are often useful when we do not need the value in the FPU stack to be present anymore after the operation.

**FABS** replace value in ST(0) by absolute value in ST(0)

**FADD** op:  $ST(0) = op + ST(0)$

**FADD** ST(0), ST(i):  $ST(0) = ST(0) + ST(i)$

**FADDP** ST(1)=ST(0)+ST(1); pop one element from the stack, i.e., the values in the stack are replaced by their sum

<sup>11</sup>MSDN

**FCHS**  $ST(0) = -ST(0)$

**FCOM** compare  $ST(0)$  with  $ST(1)$

**FCOM** op: compare  $ST(0)$  with op

**FCOMP** compare  $ST(0)$  with  $ST(1)$ ; pop one element from the stack

**FCOMPP** compare  $ST(0)$  with  $ST(1)$ ; pop two elements from the stack

**FDIVR** op:  $ST(0) = op / ST(0)$

**FDIVR**  $ST(i), ST(j)$ :  $ST(i) = ST(j) / ST(i)$

**FDIVRP** op:  $ST(0) = op / ST(0)$ ; pop one element from the stack

**FDIVRP**  $ST(i), ST(j)$ :  $ST(i) = ST(j) / ST(i)$ ; pop one element from the stack

**FDIV** op:  $ST(0) = ST(0) / op$

**FDIV**  $ST(i), ST(j)$ :  $ST(i) = ST(i) / ST(j)$

**FDIVP**  $ST(1) = ST(0) / ST(1)$ ; pop one element from the stack, i.e., the dividend and divisor values in the stack are replaced by quotient

**FILD** op: convert integer and push it to the stack.

**FIST** op: convert  $ST(0)$  to integer op

**FISTP** op: convert  $ST(0)$  to integer op; pop one element from the stack

**FLD1** push 1 to stack

**FLDCW** op: load FPU control word ( [.1.3 on page 1024](#)) from 16-bit op.

**FLDZ** push zero to stack

**FLD** op: push op to the stack.

**FMUL** op:  $ST(0) = ST(0) * op$

**FMUL**  $ST(i), ST(j)$ :  $ST(i) = ST(i) * ST(j)$

**FMULP** op:  $ST(0) = ST(0) * op$ ; pop one element from the stack

**FMULP**  $ST(i), ST(j)$ :  $ST(i) = ST(i) * ST(j)$ ; pop one element from the stack

**FSINCOS** :  $tmp = ST(0)$ ;  $ST(1) = \sin(tmp)$ ;  $ST(0) = \cos(tmp)$

**FSQRT** :  $ST(0) = \sqrt{ST(0)}$

**FSTCW** op: store FPU control word ( [.1.3 on page 1024](#)) into 16-bit op after checking for pending exceptions.

**FNSTCW** op: store FPU control word ( [.1.3 on page 1024](#)) into 16-bit op.

**FSTSW** op: store FPU status word ( [.1.3 on page 1025](#)) into 16-bit op after checking for pending exceptions.

**FNSTSW** op: store FPU status word ( [.1.3 on page 1025](#)) into 16-bit op.

**FST** op: copy  $ST(0)$  to op

**FSTP** op: copy  $ST(0)$  to op; pop one element from the stack

**FSUBR** op:  $ST(0) = op - ST(0)$

**FSUBR**  $ST(0), ST(i)$ :  $ST(0) = ST(i) - ST(0)$

**FSUBRP**  $ST(1) = ST(0) - ST(1)$ ; pop one element from the stack, i.e., the value in the stack is replaced by the difference

**FSUB** op:  $ST(0) = ST(0) - op$

**FSUB**  $ST(0), ST(i)$ :  $ST(0) = ST(0) - ST(i)$

**FSUBP**  $ST(1) = ST(1) - ST(0)$ ; pop one element from the stack, i.e., the value in the stack is replaced by the difference

**FUCOM**  $ST(i)$ : compare  $ST(0)$  and  $ST(i)$

**FUCOM** compare  $ST(0)$  and  $ST(1)$

**FUCOMP** compare  $ST(0)$  and  $ST(1)$ ; pop one element from stack.

**FUCOMPP** compare ST(0) and ST(1); pop two elements from stack.

The instructions perform just like FCOM, but an exception is raised only if one of the operands is SNaN, while QNaN numbers are processed smoothly.

**FXCH** ST(i) exchange values in ST(0) and ST(i)

**FXCH** exchange values in ST(0) and ST(1)

### Instructions having printable ASCII opcode

(In 32-bit mode).

These can be suitable for shellcode construction. See also: [8.14.1 on page 901](#).

ASCII character	hexadecimal code	x86 instruction
0	30	XOR
1	31	XOR
2	32	XOR
3	33	XOR
4	34	XOR
5	35	XOR
7	37	AAA
8	38	CMP
9	39	CMP
:	3a	CMP
;	3b	CMP
<	3c	CMP
=	3d	CMP
?	3f	AAS
@	40	INC
A	41	INC
B	42	INC
C	43	INC
D	44	INC
E	45	INC
F	46	INC
G	47	INC
H	48	DEC
I	49	DEC
J	4a	DEC
K	4b	DEC
L	4c	DEC
M	4d	DEC
N	4e	DEC
O	4f	DEC
P	50	PUSH
Q	51	PUSH
R	52	PUSH
S	53	PUSH
T	54	PUSH
U	55	PUSH
V	56	PUSH
W	57	PUSH
X	58	POP
Y	59	POP
Z	5a	POP
[	5b	POP
\	5c	POP
]	5d	POP
^	5e	POP
~	5f	POP
␣	60	PUSHA
a	61	POPA
h	68	PUSH
i	69	IMUL



j	6a	PUSH
k	6b	IMUL
p	70	JO
q	71	JNO
r	72	JB
s	73	JAE
t	74	JE
u	75	JNE
v	76	JBE
w	77	JA
x	78	JS
y	79	JNS
z	7a	JP

Also:

ASCII character	hexadecimal code	x86 instruction
f	66	(in 32-bit mode) switch to 16-bit operand size
g	67	(in 32-bit mode) switch to 16-bit address size

In summary: AAA, AAS, CMP, DEC, IMUL, INC, JA, JAE, JB, JBE, JE, JNE, JNO, JNS, JO, JP, JS, POP, POPA, PUSH, PUSHA, XOR.

## .1.7 npad

It is an assembly language macro for aligning labels on a specific boundary.

That's often needed for the busy labels to where the control flow is often passed, e.g., loop body starts. So the CPU can load the data or code from the memory effectively, through the memory bus, cache lines, etc.

Taken from `listing.inc` (MSVC):

By the way, it is a curious example of the different NOP variations. All these instructions have no effects whatsoever, but have a different size.

Having a single idle instruction instead of couple of NOP-s, is accepted to be better for CPU performance.

```
;; LISTING.INC
;;
;; This file contains assembler macros and is included by the files created
;; with the -FA compiler switch to be assembled by MASM (Microsoft Macro
;; Assembler).
;;
;; Copyright (c) 1993-2003, Microsoft Corporation. All rights reserved.

;; non destructive nops
npad macro size
if size eq 1
    nop
else
if size eq 2
    mov edi, edi
else
if size eq 3
    ; lea ecx, [ecx+00]
    DB 8DH, 49H, 00H
else
if size eq 4
    ; lea esp, [esp+00]
```



## .2 ARM

### .2.1 Terminology

ARM was initially developed as 32-bit CPU, so that's why a *word* here, unlike x86, is 32-bit.

**byte** 8-bit. The DB assembly directive is used for defining variables and arrays of bytes.

**halfword** 16-bit. DCW assembly directive —"—.

**word** 32-bit. DCD assembly directive —"—.

**doubleword** 64-bit.

**quadword** 128-bit.

### .2.2 Versions

- ARMv4: Thumb mode introduced.
- ARMv6: used in iPhone 1st gen., iPhone 3G (Samsung 32-bit RISC ARM 1176JZ(F)-S that supports Thumb-2)
- ARMv7: Thumb-2 was added (2003). was used in iPhone 3GS, iPhone 4, iPad 1st gen. (ARM Cortex-A8), iPad 2 (Cortex-A9), iPad 3rd gen.
- ARMv7s: New instructions added. iPhone 5, iPhone 5c, iPad 4th gen. (Apple A6).
- ARMv8: 64-bit CPU, **AKA** ARM64 **AKA** AArch64. Was used in iPhone 5S, iPad Air (Apple A7). There is no Thumb mode in 64-bit mode, only ARM (4-byte instructions).

### .2.3 32-bit ARM (AArch32)

#### General purpose registers

- R0 — function result is usually returned using R0
- R1...R12 — GPRs
- R13 — **AKA** SP ([stack pointer](#))
- R14 — **AKA** LR ([link register](#))
- R15 — **AKA** PC (program counter)

R0-R3 are also called "scratch registers": the function's arguments are usually passed in them, and the values in them are not required to be restored upon the function's exit.

#### Current Program Status Register (CPSR)

Bit	Description
0..4	M — processor mode
5	T — Thumb state
6	F — FIQ disable
7	I — IRQ disable
8	A — imprecise data abort disable
9	E — data endianness
10..15, 25, 26	IT — if-then state
16..19	GE — greater-than-or-equal-to
20..23	DNM — do not modify
24	J — Java state
27	Q — sticky overflow
28	V — overflow
29	C — carry/borrow/extend
30	Z — zero bit
31	N — negative/less than

## VFP (floating point) and NEON registers

0..31 <sup>bits</sup>	32..64	65..96	97..127
Q0 <sup>128 bits</sup>			
D0 <sup>64 bits</sup>		D1	
S0 <sup>32 bits</sup>	S1	S2	S3

S-registers are 32-bit, used for the storage of single precision numbers.

D-registers are 64-bit ones, used for the storage of double precision numbers.

D- and S-registers share the same physical space in the CPU—it is possible to access a D-register via the S-registers (it is senseless though).

Likewise, the **NEON** Q-registers are 128-bit ones and share the same physical space in the CPU with the other floating point registers.

In VFP 32 S-registers are present: S0..S31.

In VFPv2 there 16 D-registers are added, which in fact occupy the same space as S0..S31.

In VFPv3 (**NEON** or “Advanced SIMD”) there are 16 more D-registers, D0..D31, but the D16..D31 registers are not sharing space with any other S-registers.

In **NEON** or “Advanced SIMD” another 16 128-bit Q-registers were added, which share the same space as D0..D31.

## .2.4 64-bit ARM (AArch64)

### General purpose registers

The number of registers has been doubled since AArch32.

- X0 — function result is usually returned using X0
- X0...X7 — Function arguments are passed here.
- X8
- X9...X15 — are temporary registers, the callee function can use and not restore them.
- X16
- X17
- X18
- X19...X29 — callee function can use them, but must restore them upon exit.
- X29 — used as **FP** (at least GCC)
- X30 — “Procedure Link Register” **AKA LR** ([link register](#)).
- X31—register always contains zero **AKA XZR** or “Zero Register”. It’s 32-bit part is called **WZR**.
- **SP**, not a general purpose register anymore.

See also: [*Procedure Call Standard for the ARM 64-bit Architecture (AArch64)*, (2013)]<sup>12</sup>.

The 32-bit part of each X-register is also accessible via W-registers (W0, W1, etc.).

High 32-bit part	low 32-bit part
X0	
	W0

## .2.5 Instructions

There is a **-S** suffix for some instructions in ARM, indicating that the instruction sets the flags according to the result. Instructions which lacks this suffix are not modify flags. For example **ADD** unlike **ADDs** will add two numbers, but the flags will not be touched. Such instructions are convenient to use between **CMP** where the flags are set and, e.g. conditional jumps, where the flags are used. They are also better in terms of data dependency analysis (because less number of registers are modified during execution).

<sup>12</sup>Also available as <http://go.yurichev.com/17287>

## Conditional codes table

Code	Description	Flags
EQ	Equal	Z == 1
NE	Not equal	Z == 0
CS <i>AKA</i> HS (Higher or Same)	Carry set / Unsigned, Greater than, equal	C == 1
CC <i>AKA</i> LO (LOwer)	Carry clear / Unsigned, Less than	C == 0
MI	Minus, negative / Less than	N == 1
PL	Plus, positive or zero / Greater than, equal	N == 0
VS	Overflow	V == 1
VC	No overflow	V == 0
HI	Unsigned higher / Greater than	C == 1 and Z == 0
LS	Unsigned lower or same / Less than or equal	C == 0 or Z == 1
GE	Signed greater than or equal / Greater than or equal	N == V
LT	Signed less than / Less than	N != V
GT	Signed greater than / Greater than	Z == 0 and N == V
LE	Signed less than or equal / Less than, equal	Z == 1 or N != V
None / AL	Always	Any

## .3 MIPS

### .3.1 Registers

( O32 calling convention )

#### General purpose registers **GPR**

Number	Pseudoname	Description
\$0	\$ZERO	Always zero. Writing to this register is like <b>NOP</b> .
\$1	\$AT	Used as a temporary register for assembly macros and pseudo instructions.
\$2 ...\$3	\$V0 ...\$V1	Function result is returned here.
\$4 ...\$7	\$A0 ...\$A3	Function arguments.
\$8 ...\$15	\$T0 ...\$T7	Used for temporary data.
\$16 ...\$23	\$S0 ...\$S7	Used for temporary data*.
\$24 ...\$25	\$T8 ...\$T9	Used for temporary data.
\$26 ...\$27	\$K0 ...\$K1	Reserved for <b>OS</b> kernel.
\$28	\$GP	Global Pointer**.
\$29	\$SP	<b>SP</b> *.
\$30	\$FP	<b>FP</b> *.
\$31	\$RA	<b>RA</b> .
n/a	PC	<b>PC</b> .
n/a	HI	high 32 bit of multiplication or division remainder***.
n/a	LO	low 32 bit of multiplication and division remainder***.

#### Floating-point registers

Name	Description
\$F0..\$F1	Function result returned here.
\$F2..\$F3	Not used.
\$F4..\$F11	Used for temporary data.
\$F12..\$F15	First two function arguments.
\$F16..\$F19	Used for temporary data.
\$F20..\$F31	Used for temporary data*.

\* — Callee must preserve the value.

\*\* — Callee must preserve the value ( except in **PIC** code).

\*\*\* — accessible using the **MFHI** and **MFL0** instructions.

### .3.2 Instructions

There are 3 kinds of instructions:

- R-type: those which have 3 registers. R-instruction usually have the following form:

```
instruction destination, source1, source2
```

One important thing to keep in mind is that when the first and second register are the same, IDA may show the instruction in its shorter form:

```
instruction destination/source1, source2
```

That somewhat reminds us of the Intel syntax for x86 assembly language.

- I-type: those which have 2 registers and a 16-bit immediate value.
- J-type: jump/branch instructions, have 26 bits for encoding the offset.

### Jump instructions

What is the difference between B- instructions (BEQ, B, etc.) and J- ones (JAL, JALR, etc.)?

The B-instructions have an I-type, hence, the B-instructions' offset is encoded as a 16-bit immediate. JR and JALR are R-type and jump to an absolute address specified in a register. J and JAL are J-type, hence the offset is encoded as a 26-bit immediate.

In short, B-instructions can encode a condition (B is in fact pseudo instruction for BEQ \$ZERO, \$ZERO, LABEL), while J-instructions can't.

## .4 Some GCC library functions

name	meaning
__divdi3	signed division
__moddi3	getting remainder (modulo) of signed division
__udivdi3	unsigned division
__umoddi3	getting remainder (modulo) of unsigned division

## .5 Some MSVC library functions

ll in function name stands for "long long", e.g., a 64-bit data type.

name	meaning
__alldiv	signed division
__allmul	multiplication
__allrem	remainder of signed division
__allshl	shift left
__allshr	signed shift right
__aulldiv	unsigned division
__aullrem	remainder of unsigned division
__aullshr	unsigned shift right

Multiplication and shift left procedures are the same for both signed and unsigned numbers, hence there is only one function for each operation here .

The source code of these function can be found in the installed [MSVS](#), in VC/crt/src/intel/\*.asm.

## .6 Cheatsheets

### .6.1 IDA

Hot-keys cheatsheet:

key	meaning
Space	switch listing and graph view
C	convert to code
D	convert to data
A	convert to string
*	convert to array
U	undefine
O	make offset of operand
H	make decimal number
R	make char
B	make binary number
Q	make hexadecimal number
N	rename identifier
?	calculator
G	jump to address
:	add comment
Ctrl-X	show references to the current function, label, variable (incl. in local stack)
X	show references to the function, label, variable, etc.
Alt-I	search for constant
Ctrl-I	search for the next occurrence of constant
Alt-B	search for byte sequence
Ctrl-B	search for the next occurrence of byte sequence
Alt-T	search for text (including instructions, etc.)
Ctrl-T	search for the next occurrence of text
Alt-P	edit current function
Enter	jump to function, variable, etc.
Esc	get back
Num -	fold function or selected area
Num +	unhide function or area

Function/area folding may be useful for hiding function parts when you realize what they do. this is used in `myscript`<sup>13</sup> for hiding some often used patterns of inline code.

## .6.2 OllyDbg

Hot-keys cheatsheet:

hot-key	meaning
F7	trace into
F8	step over
F9	run
Ctrl-F2	restart

## .6.3 MSVC

Some useful options which were used through this book. .

option	meaning
/O1	minimize space
/Ob0	no inline expansion
/Ox	maximum optimizations
/GS-	disable security checks (buffer overflows)
/Fa(file)	generate assembly listing
/Zi	enable debugging information
/Zp(n)	pack structs on <i>n</i> -byte boundary
/MD	produced executable will use MSVCR*.DLL

Some information about MSVC versions: [5.1.1 on page 702](#).

## .6.4 GCC

Some useful options which were used through this book.

<sup>13</sup>[GitHub](#)

option	meaning
-Os	code size optimization
-O3	maximum optimization
-regparm=	how many arguments are to be passed in registers
-o file	set name of output file
-g	produce debugging information in resulting executable
-S	generate assembly listing file
-masm=intel	produce listing in Intel syntax
-fno-inline	do not inline functions

## .6.5 GDB

Some of commands we used in this book:

option	meaning
break filename.c:number	set a breakpoint on line number in source code
break function	set a breakpoint on function
break *address	set a breakpoint on address
b	—” —
p variable	print value of variable
run	run
r	—” —
cont	continue execution
c	—” —
bt	print stack
set disassembly-flavor intel	set Intel syntax
disas	disassemble current function
disas function	disassemble function
disas function,+50	disassemble portion
disas \$eip,+0x10	—” —
disas/r	disassemble with opcodes
info registers	print all registers
info float	print FPU-registers
info locals	dump local variables (if known)
x/w ...	dump memory as 32-bit word
x/w \$rdi	dump memory as 32-bit word at address in RDI
x/10w ...	dump 10 memory words
x/s ...	dump memory as string
x/i ...	dump memory as code
x/10c ...	dump 10 characters
x/b ...	dump bytes
x/h ...	dump 16-bit halfwords
x/g ...	dump giant (64-bit) words
finish	execute till the end of function
next	next instruction (don't dive into functions)
step	next instruction (dive into functions)
set step-mode on	do not use line number information while stepping
frame n	switch stack frame
info break	list of breakpoints
del n	delete breakpoint
set args ...	set command-line arguments



# **Acronyms Used**

<b>OS</b> Operating System .....	xv
<b>OOP</b> Object-Oriented Programming.....	547
<b>PL</b> Programming Language .....	xiii
<b>PRNG</b> Pseudorandom Number Generator .....	viii
<b>ROM</b> Read-Only Memory .....	82
<b>ALU</b> Arithmetic Logic Unit.....	25
<b>PID</b> Program/process ID.....	810
<b>LF</b> Line Feed (10 or '\n' in C/C++) .....	528
<b>CR</b> Carriage Return (13 or '\r' in C/C++) .....	528
<b>LIFO</b> Last In First Out .....	30
<b>MSB</b> Most Significant Bit.....	318
<b>LSB</b> Least Significant Bit .....	
<b>NSA</b> National Security Agency .....	464
<b>CFB</b> Cipher Feedback .....	857
<b>CSPRNG</b> Cryptographically Secure Pseudorandom Number Generator .....	858
<b>ABI</b> Application Binary Interface.....	15
<b>RA</b> Return Address .....	21
<b>PE</b> Portable Executable .....	5
<b>SP</b> <a href="#">stack pointer</a> . SP/ESP/RSP in x86/x64. SP in ARM.....	18
<b>DLL</b> Dynamic-Link Library .....	758
<b>PC</b> Program Counter. IP/EIP/RIP in x86/64. PC in ARM.....	19
<b>LR</b> Link Register .....	6
<b>IDA</b> Interactive Disassembler and Debugger developed by <a href="#">Hex-Rays</a> .....	6
<b>IAT</b> Import Address Table.....	759
<b>INT</b> Import Name Table.....	759
<b>RVA</b> Relative Virtual Address .....	759

<b>VA</b> Virtual Address .....	759
<b>OEP</b> Original Entry Point .....	748
<b>MSVC</b> Microsoft Visual C++ .....	
<b>MSVS</b> Microsoft Visual Studio .....	1035
<b>ASLR</b> Address Space Layout Randomization .....	612
<b>MFC</b> Microsoft Foundation Classes .....	762
<b>TLS</b> Thread Local Storage .....	282
<b>AKA</b> Also Known As .....	30
<b>CRT</b> C Runtime library .....	10
<b>CPU</b> Central Processing Unit .....	xv
<b>GPU</b> Graphics Processing Unit .....	868
<b>FPU</b> Floating-Point Unit .....	v
<b>CISC</b> Complex Instruction Set Computing .....	19
<b>RISC</b> Reduced Instruction Set Computing .....	2
<b>GUI</b> Graphical User Interface .....	755
<b>RTTI</b> Run-Time Type Information .....	561
<b>BSS</b> Block Started by Symbol .....	24
<b>SIMD</b> Single Instruction, Multiple Data .....	195
<b>BSOD</b> Blue Screen of Death .....	749
<b>DBMS</b> Database Management Systems .....	xiii
<b>ISA</b> Instruction Set Architecture .....	ix
<b>HPC</b> High-Performance Computing .....	521
<b>SEH</b> Structured Exception Handling .....	37
<b>ELF</b> Executable File format widely used in *NIX systems including Linux .....	80
<b>TIB</b> Thread Information Block .....	282
<b>PIC</b> Position Independent Code .....	542

<b>NAN</b> Not a Number .....	1026
<b>NOP</b> No Operation.....	6
<b>BEQ</b> (PowerPC, ARM) Branch if Equal.....	95
<b>BNE</b> (PowerPC, ARM) Branch if Not Equal .....	209
<b>BLR</b> (PowerPC) Branch to Link Register.....	830
<b>XOR</b> eXclusive OR.....	1032
<b>MCU</b> Microcontroller Unit .....	499
<b>RAM</b> Random-Access Memory .....	3
<b>GCC</b> GNU Compiler Collection .....	4
<b>EGA</b> Enhanced Graphics Adapter .....	1000
<b>VGA</b> Video Graphics Array.....	1000
<b>API</b> Application Programming Interface .....	623
<b>ASCII</b> American Standard Code for Information Interchange .....	292
<b>ASCIIZ</b> ASCII Zero (null-terminated ASCII string ) .....	93
<b>IA64</b> Intel Architecture 64 (Itanium) .....	465
<b>EPIC</b> Explicitly Parallel Instruction Computing .....	998
<b>OOE</b> Out-of-Order Execution.....	466
<b>MSDN</b> Microsoft Developer Network.....	616
<b>STL</b> (C++) Standard Template Library.....	568
<b>PODT</b> (C++) Plain Old Data Type .....	580
<b>HDD</b> Hard Disk Drive.....	591
<b>VM</b> Virtual Memory	
<b>WRK</b> Windows Research Kernel.....	719
<b>GPR</b> General Purpose Registers.....	2
<b>SSDT</b> System Service Dispatch Table .....	749
<b>RE</b> Reverse Engineering .....	1016

<b>RAID</b> Redundant Array of Independent Disks .....	vi
<b>BCD</b> Binary-Coded Decimal.....	447
<b>BOM</b> Byte Order Mark.....	709
<b>GDB</b> GNU Debugger .....	49
<b>FP</b> Frame Pointer.....	23
<b>MBR</b> Master Boot Record .....	714
<b>JPE</b> Jump Parity Even (x86 instruction) .....	237
<b>CIDR</b> Classless Inter-Domain Routing.....	489
<b>STMFd</b> Store Multiple Full Descending (ARM instruction)	
<b>LDMFd</b> Load Multiple Full Descending (ARM instruction)	
<b>STMED</b> Store Multiple Empty Descending (ARM instruction).....	30
<b>LDMED</b> Load Multiple Empty Descending (ARM instruction).....	30
<b>STMFA</b> Store Multiple Full Ascending (ARM instruction).....	30
<b>LDMFA</b> Load Multiple Full Ascending (ARM instruction).....	30
<b>STMEA</b> Store Multiple Empty Ascending (ARM instruction).....	30
<b>LDMEA</b> Load Multiple Empty Ascending (ARM instruction).....	30
<b>APSR</b> (ARM) Application Program Status Register.....	260
<b>FPSCR</b> (ARM) Floating-Point Status and Control Register.....	260
<b>RFC</b> Request for Comments.....	713
<b>TOS</b> Top of Stack.....	662
<b>LVA</b> (Java) Local Variable Array.....	669
<b>JVM</b> Java Virtual Machine .....	viii
<b>JIT</b> Just-In-Time compilation.....	661
<b>CDFS</b> Compact Disc File System .....	725
<b>CD</b> Compact Disc	
<b>ADC</b> Analog-to-Digital Converter.....	721

<b>EOF</b> End of File .....	86
<b>DIY</b> Do It Yourself .....	619
<b>MMU</b> Memory Management Unit.....	610
<b>DES</b> Data Encryption Standard .....	448
<b>MIME</b> Multipurpose Internet Mail Extensions.....	448
<b>DBI</b> Dynamic Binary Instrumentation .....	527
<b>XML</b> Extensible Markup Language .....	628
<b>JSON</b> JavaScript Object Notation .....	628
<b>URL</b> Uniform Resource Locator .....	4
<b>IV</b> Initialization Vector .....	x
<b>RSA</b> Rivest Shamir Adleman.....	953
<b>CPRNG</b> Cryptographically secure PseudoRandom Number Generator.....	954
<b>GiB</b> Gibibyte .....	968
<b>CRC</b> Cyclic redundancy check .....	988
<b>AES</b> Advanced Encryption Standard .....	988
<b>GC</b> Garbage Collector .....	617
<b>IDE</b> Integrated development environment .....	376
<b>BB</b> Basic Block.....	1011

# Glossary

**anti-pattern** Generally considered as bad practice. [32](#), [77](#), [466](#)

**arithmetic mean** a sum of all values divided by their count. [522](#)

**atomic operation** “*ατομος*” stands for “indivisible” in Greek, so an atomic operation is guaranteed not to be interrupted by other threads. [640](#), [790](#)

**basic block** a group of instructions that do not have jump/branch instructions, and also don't have jumps inside the block from the outside. In [IDA](#) it looks just like as a list of instructions without empty lines. [693](#), [1001](#), [1002](#)

**callee** A function being called by another. [32](#), [47](#), [68](#), [87](#), [98](#), [100](#), [102](#), [421](#), [466](#), [548](#), [651](#), [735–738](#), [740](#), [741](#), [1043](#)

**caller** A function calling another. [6–8](#), [10](#), [29](#), [47](#), [87](#), [98](#), [99](#), [101](#), [109](#), [156](#), [421](#), [475](#), [548](#), [735–738](#), [741](#)

**compiler intrinsic** A function specific to a compiler which is not an usual library function. The compiler generates a specific machine code instead of a call to it. Often, it's a pseudofunction for a specific CPU instruction. Read more: ([11.3 on page 995](#)). [1035](#)

**CP/M** Control Program for Microcomputers: a very basic disk [OS](#) used before MS-DOS. [901](#)

**decrement** Decrease by 1. [18](#), [184](#), [185](#), [203](#), [440](#), [728](#), [1028](#), [1031](#), [1035](#)

**dongle** Dongle is a small piece of hardware connected to LPT printer port (in past) or to USB. [829](#)

**endianness** Byte order. [21](#), [79](#), [346](#), [1032](#)

**GiB** Gibibyte:  $2^{30}$  or 1024 mebibytes or 1073741824 bytes. [15](#)

**heap** usually, a big chunk of memory provided by the [OS](#) so that applications can divide it by themselves as they wish. `malloc()/free()` work with the heap. [30](#), [348](#), [564](#), [567](#), [580](#), [581](#), [596](#), [597](#), [629](#), [757](#), [758](#)

**increment** Increase by 1. [16](#), [19](#), [185](#), [188](#), [203](#), [209](#), [327](#), [330](#), [440](#), [1028](#)

**integral data type** usual numbers, but not a real ones. may be used for passing variables of boolean data type and enumerations. [231](#)

**jump offset** a part of the `JMP` or `Jcc` instruction's opcode, to be added to the address of the next instruction, and this is how the new [PC](#) is calculated. May be negative as well. [94](#), [133](#), [1028](#)

**leaf function** A function which does not call any other function. [28](#), [32](#)

**link register** (RISC) A register where the return address is usually stored. This makes it possible to call leaf functions without using the stack, i.e., faster. [32](#), [830](#), [1041](#), [1042](#)

**loop unwinding** It is when a compiler, instead of generating loop code for  $n$  iterations, generates just  $n$  copies of the loop body, in order to get rid of the instructions for loop maintenance. [187](#)

**name mangling** used at least in C++, where the compiler needs to encode the name of class, method and argument types in one string, which will become the internal name of the function. You can read more about it here: [3.21.1 on page 547](#). [547](#), [703](#), [704](#)

**NaN** not a number: a special cases for floating point numbers, usually signaling about errors. [233](#), [255](#), [1000](#)

**NEON** AKA “Advanced SIMD”—SIMD from ARM. [1041](#), [1042](#)

**NOP** “no operation”, idle instruction. [728](#)

**NTAPI** [API](#) available only in the Windows NT line. Largely not documented by Microsoft. [797](#)

**padding** *Padding* in English language means to stuff a pillow with something to give it a desired (bigger) form. In computer science, padding means to add more bytes to a block so it will have desired size, like  $2^n$  bytes.. [711](#)

**PDB** (Win32) Debugging information file, usually just function names, but sometimes also function arguments and local variables names. [702](#), [760](#), [797](#), [798](#), [805](#), [806](#), [884](#)

**POKE** BASIC language instruction for writing a byte at a specific address. [728](#)

**product** Multiplication result. [98](#), [224](#), [227](#), [409](#), [433](#), [454](#)

**quotient** Division result. [218](#), [220](#), [222](#), [223](#), [227](#), [432](#), [501](#), [524](#)

**real number** numbers which may contain a dot. this is *float* and *double* in C/C++. [218](#)

**register allocator** The part of the compiler that assigns CPU registers to local variables. [202](#), [308](#), [422](#)

**reverse engineering** act of understanding how the thing works, sometimes in order to clone it. [iii](#), [1035](#)

**security cookie** A random value, different at each execution. You can read more about it here: [1.26.3 on page 281](#). [780](#)

**stack frame** A part of the stack that contains information specific to the current function: local variables, function arguments, [RA](#), etc.. [69](#), [98](#), [99](#), [482](#), [780](#)

**stack pointer** A register pointing to a place in the stack. [9](#), [11](#), [19](#), [30](#), [35](#), [43](#), [55](#), [57](#), [74](#), [100](#), [548](#), [651](#), [735-738](#), [1022](#), [1029](#), [1041](#), [1048](#)

**stdout** standard output. [21](#), [35](#), [156](#)

**tail call** It is when the compiler (or interpreter) transforms the recursion (*tail recursion*) into an iteration for efficiency. [485](#)

**thunk function** Tiny function with a single role: call another function. [22](#), [42](#), [392](#), [830](#), [839](#)

**tracer** My own simple debugging tool. You can read more about it here: [7.2.1 on page 792](#). [189-191](#), [545](#), [615](#), [706](#), [717](#), [719](#), [720](#), [776](#), [785](#), [825](#), [826](#), [886](#), [892](#), [896](#), [897](#), [899](#), [916](#), [994](#)

**user mode** A restricted CPU mode in which it all application software code is executed. cf. [kernel mode](#). [846](#)

**Windows NT** Windows NT, 2000, XP, Vista, 7, 8, 10. [291](#), [419](#), [650](#), [709](#), [749](#), [759](#), [789](#), [904](#), [1034](#)

**word** data type fitting in [GPR](#). In the computers older than PCs, the memory size was often measured in words rather than bytes.. [447-450](#), [455](#), [570](#), [630](#)

**xoring** often used in the English language, which implying applying the [XOR](#) operation. [780](#), [842](#), [845](#)



# Index

- .NET, 765
- 0x0BADF00D, 76
- 0xCCCCCCCC, 76
  
- Ada, 106
- AES, 855
- Alpha AXP, 2
- AMD, 740
- Angband, 303
- Angry Birds, 261, 262
- Apollo Guidance Computer, 211
- ARM, 209, 732, 830, 1040
  - Addressing modes, 440
  - ARM mode, 2
  - ARM1, 450
  - armel, 227
  - armhf, 227
  - Condition codes, 136
  - D-registers, 226, 1041
  - Data processing instructions, 503
  - DCB, 19
  - hard float, 227
  - if-then block, 260
  - Instructions
    - ADC, 398
    - ADD, 20, 106, 136, 192, 322, 334, 503, 1042
    - ADDAL, 136
    - ADDCC, 175
    - ADDS, 104, 398, 1042
    - ADR, 19, 136
    - ADRcc, 136, 164, 466
    - ADRP/ADD pair, 23, 56, 83, 288, 302, 443
    - ANDcc, 539
    - ASR, 337
    - ASRS, 316, 503
    - B, 55, 136, 137
    - Bcc, 96, 97, 147
    - BCS, 137, 263
    - BEQ, 95, 164
    - BGE, 137
    - BIC, 316, 321, 339
    - BL, 19–23, 136, 444
    - BLcc, 136
    - BLE, 137
    - BLS, 137
    - BLT, 192
    - BLX, 21
    - BNE, 137
    - BX, 103, 176
    - CMP, 95, 96, 136, 164, 175, 192, 334, 1042
    - CSEL, 145, 149, 151, 334
    - EOR, 321
    - FCMPE, 263
    - FCSEL, 263
    - FMOV, 442
    - FMRS, 322
    - IT, 152, 260, 284
    - LDMccFD, 136
    - LDMEA, 30
    - LDMED, 30
    - LDMFA, 30
    - LDMFD, 19, 30, 136
    - LDP, 24
    - LDR, 57, 74, 82, 270, 287, 440
    - LDRB, 364
    - LDRB.W, 209
    - LDRSB, 209
    - LEA, 466
    - LSL, 334, 337
    - LSL.W, 334
    - LSLR, 539
    - LSLS, 271, 321, 539
    - LSR, 337
    - LSRS, 321
    - MADD, 104
    - MLA, 103, 104
    - MOV, 8, 19, 20, 334, 503
    - MOVcc, 147, 151
    - MOVK, 442
    - MOVT, 20, 503
    - MOVT.W, 21
    - MOVW, 21
    - MUL, 106
    - MULS, 104
    - MVNS, 209
    - NEG, 510
    - ORR, 316
    - POP, 18–20, 30, 32
    - PUSH, 20, 30, 32
    - RET, 24
    - RSB, 141, 297, 334, 510
    - SBC, 398
    - SMMUL, 503
    - STMEA, 30
    - STMED, 30
    - STMFA, 30, 58
    - STMFD, 18, 30
    - STMIA, 57
    - STMIB, 58
    - STP, 23, 56
    - STR, 57, 270
    - SUB, 57, 297, 334
    - SUBcc, 539
    - SUBEQ, 210
    - SUBS, 398
    - SXTB, 365
    - SXTW, 302

- TEST, 202
- TST, 309, 334
- VADD, 227
- VDIV, 227
- VLDR, 227
- VMOV, 227, 260
- VMOVGT, 260
- VMRS, 260
- VMUL, 227
- XOR, 142, 322
- Leaf function, 32
- Mode switching, 103, 176
- mode switching, 21
- Optional operators
  - ASR, 334, 503
  - LSL, 270, 297, 334, 442
  - LSR, 334, 503
  - ROR, 334
  - RRX, 334
- Pipeline, 175
- Registers
  - APSR, 260
  - FPSCR, 260
  - Link Register, 19, 32, 55, 177, 1041
  - R0, 107, 1041
  - scratch registers, 209, 1041
  - X0, 1042
  - Z, 95, 1041
- S-registers, 226, 1041
- soft float, 227
- Thumb mode, 2, 137, 176
- Thumb-2 mode, 2, 176, 260, 262
- ARM64
  - lo12, 56
- ASLR, 759
- AT&T syntax, 12, 37
- AWK, 718
- Base address, 758
- base32, 711
- Base64, 711
- base64, 713, 852, 955
- base64scanner, 464, 711
- bash, 108
- BASIC
  - POKE, 728
- BeagleBone, 863
- binary grep, 716, 791
- Binary Ninja, 791
- Binary tree, 587
- BIND.EXE, 764
- BinNavi, 791
- binutils, 379
- Binwalk, 947
- Bitcoin, 636, 863
- Boehm garbage collector, 618
- Boolector, 42
- Booth's multiplication algorithm, 217
- Borland C++, 608
- Borland C++Builder, 704
- Borland Delphi, 14, 704, 707, 1036
- BSoD, 749
- BSS, 760
- Buffer Overflow, 273, 280, 780
- C language elements
  - C99, 109
    - bool, 305
    - restrict, 519
    - variable length arrays, 284
  - Comma, 1006
  - const, 9, 82, 472
  - for, 184, 487
  - if, 124, 155
  - Pointers, 68, 74, 110, 384, 421, 600
  - Post-decrement, 440
  - Post-increment, 440
  - Pre-decrement, 440
  - Pre-increment, 440
  - ptrdiff\_t, 618
  - return, 10, 87, 109
  - Short-circuit, 529, 531, 1007
  - switch, 154, 155, 164
  - while, 201
- C standard library
  - alloca(), 35, 284, 466, 771
  - assert(), 290, 713
  - atexit(), 569
  - atoi(), 504, 875
  - close(), 753
  - exit(), 475
  - fread(), 626
  - free(), 466, 597
  - fwrite(), 626
  - getenv(), 876
  - localtime(), 659
  - localtime\_r(), 355
  - longjmp, 630
  - longjmp(), 156
  - malloc(), 348, 466, 597
  - memchr(), 1031
  - memcmp(), 452, 517, 715, 1032
  - memcpy(), 12, 68, 515, 629, 1030
  - memmove(), 629
  - memset(), 265, 514, 896, 1031, 1032
  - open(), 753
  - pow(), 229
  - puts(), 20
  - qsort(), 384, 474
  - rand(), 339, 705, 803, 805, 824, 850
  - read(), 626, 753
  - realloc(), 466
  - scanf(), 67
  - setjmp, 630
  - srand(), 824
  - strcat(), 518
  - strcmp(), 452, 475, 511, 753
  - strcpy(), 12, 513, 851
  - strlen(), 201, 418, 513, 530, 1031
  - strstr(), 474
  - strtok, 212
  - time(), 659, 824
  - toupper(), 537
  - va\_arg, 523
  - va\_list, 526
  - vprintf, 526
  - write(), 626
- C++, 888
  - C++11, 580, 744

- exceptions, [771](#)
- ostream, [562](#)
- References, [563](#)
- RTTI, [561](#)
- STL, [702](#)
  - std::forward\_list, [579](#)
  - std::list, [570](#)
  - std::map, [587](#)
  - std::set, [587](#)
  - std::string, [563](#)
  - std::vector, [580](#)
- C11, [744](#)
- Callbacks, [384](#)
- Canary, [281](#)
- cdecl, [43](#), [735](#)
- Chess, [463](#)
- Cipher Feedback mode, [857](#)
- clusterization, [952](#)
- COFF, [837](#)
- column-major order, [292](#)
- Compiler intrinsic, [36](#), [454](#), [995](#)
- Compiler's anomalies, [147](#), [301](#), [316](#), [333](#), [497](#), [535](#), [995](#)
- Core dump, [611](#)
- Cray, [408](#), [450](#), [461](#), [464](#)
- CRC32, [467](#), [486](#)
- CRT, [755](#), [776](#)
- CryptoMiniSat, [428](#)
- CryptoPP, [734](#), [855](#)
- Cygwin, [703](#), [706](#), [765](#), [793](#)
  
- Data general Nova, [217](#)
- De Morgan's laws, [1008](#)
- DEC Alpha, [407](#)
- DES, [408](#), [422](#)
- dlopen(), [753](#)
- dlsym(), [753](#)
- dmalloc, [611](#)
- Donald E. Knuth, [450](#)
- DOSBox, [904](#)
- DosBox, [720](#)
- double, [219](#), [740](#)
- Doubly linked list, [462](#), [570](#)
- dtruss, [792](#)
- Duff's device, [498](#)
- Dynamically loaded libraries, [22](#)
  
- Edsger W. Dijkstra, [598](#)
- EICAR, [901](#)
- ELF, [80](#)
- Entropy, [925](#), [944](#)
- Error messages, [713](#)
  
- fastcall, [14](#), [34](#), [67](#), [307](#), [736](#)
- fetchmail, [448](#)
- FidoNet, [711](#)
- FILETIME, [405](#)
- FIXUP, [827](#)
- float, [219](#), [740](#)
- Forth, [685](#)
- FORTTRAN, [22](#)
- Fortran, [292](#), [519](#), [598](#), [703](#)
- FreeBSD, [715](#)
- Function epilogue, [29](#), [55](#), [57](#), [136](#), [364](#), [718](#)
- Function prologue, [10](#), [29](#), [32](#), [57](#), [281](#), [718](#)
  
- Fused multiply-add, [103](#), [104](#)
- Fuzzing, [510](#)
  
- Garbage collector, [617](#), [686](#)
- GCC, [703](#), [1044](#), [1045](#)
- GDB, [28](#), [48](#), [52](#), [280](#), [392](#), [393](#), [792](#), [1046](#)
- GeolIP, [945](#)
- GHex, [791](#)
- Glibc, [392](#), [630](#), [748](#)
- Global variables, [77](#)
- GNU Scientific Library, [359](#)
- GnuPG, [954](#)
- GraphViz, [617](#)
- grep usage, [191](#), [262](#), [702](#), [716](#), [719](#), [885](#)
  
- Hash functions, [467](#)
- HASP, [715](#)
- Heartbleed, [629](#), [863](#)
- Heisenbug, [636](#), [645](#)
- Hex-Rays, [108](#), [198](#), [298](#), [303](#), [619](#), [643](#), [1002](#)
- Hiew, [93](#), [133](#), [154](#), [707](#), [712](#), [760](#), [761](#), [765](#), [791](#), [994](#)
- Honeywell 6070, [448](#)
  
- ICQ, [728](#)
- IDA, [87](#), [154](#), [379](#), [518](#), [696](#), [710](#), [791](#), [792](#), [976](#), [1044](#)
  - var\_?, [57](#), [74](#)
- IEEE 754, [218](#), [318](#), [377](#), [428](#), [1020](#)
- Inline code, [193](#), [315](#), [510](#), [553](#), [583](#)
- Integer overflow, [106](#)
- Intel
  - 8080, [209](#)
  - 8086, [209](#), [315](#), [846](#)
    - Memory model, [657](#), [1000](#)
  - 8253, [903](#)
  - 80286, [846](#), [1001](#)
  - 80386, [315](#), [1001](#)
  - 80486, [218](#)
  - FPU, [218](#)
- Intel 4004, [447](#)
- Intel C++, [9](#), [409](#), [995](#), [1001](#), [1029](#)
- Intel syntax, [12](#), [18](#)
- iPod/iPhone/iPad, [18](#)
- Itanium, [407](#), [998](#)
  
- JAD, [5](#)
- Java, [449](#), [661](#)
- John Carmack, [528](#)
- JPEG, [952](#)
- jumptable, [168](#), [176](#)
  
- Keil, [18](#)
- kernel panic, [749](#)
- kernel space, [748](#)
  
- LAPACK, [22](#)
- LARGE\_INTEGER, [405](#)
- LD\_PRELOAD, [752](#)
- Linker, [82](#), [547](#)
- Linux, [308](#), [750](#), [888](#)
  - libc.so.6, [307](#), [392](#)
- LISP, [604](#)
- LLDB, [792](#)
- LLVM, [18](#)

- long double, [219](#)
- Loop unwinding, [187](#)
- LZMA, [947](#)
- Mac OS Classic, [829](#)
- Mac OS X, [793](#)
- Mathematica, [598](#), [815](#)
- MD5, [467](#), [714](#)
- memfrob(), [854](#)
- Memoization, [816](#)
- MFC, [762](#), [876](#)
- Microsoft, [405](#)
- Microsoft Word, [629](#)
- MIDI, [715](#)
- MinGW, [703](#), [915](#)
- minifloat, [442](#)
- MIPS, [2](#), [722](#), [733](#), [760](#), [830](#), [951](#)
  - Branch delay slot, [8](#)
  - Global Pointer, [24](#), [298](#)
  - Instructions
    - ADD, [106](#)
    - ADDIU, [25](#), [85](#), [86](#)
    - ADDU, [106](#)
    - AND, [317](#)
    - BC1F, [265](#)
    - BC1T, [265](#)
    - BEQ, [97](#), [138](#)
    - BLTZ, [142](#)
    - BNE, [138](#)
    - BNEZ, [178](#)
    - BREAK, [503](#)
    - C.LT.D, [265](#)
    - J, [6](#), [8](#), [25](#)
    - JAL, [106](#)
    - JALR, [25](#), [106](#)
    - JR, [167](#)
    - LB, [198](#)
    - LBU, [198](#)
    - LI, [444](#)
    - LUI, [25](#), [85](#), [86](#), [320](#), [444](#)
    - LW, [25](#), [75](#), [86](#), [167](#), [445](#)
    - MFHI, [106](#), [504](#), [1043](#)
    - MFLO, [106](#), [504](#), [1043](#)
    - MTC1, [381](#)
    - MULT, [106](#)
    - NOR, [211](#)
    - OR, [28](#)
    - ORI, [317](#), [444](#)
    - SB, [198](#)
    - SLL, [178](#), [213](#), [336](#)
    - SLLV, [336](#)
    - SLT, [138](#)
    - SLTIU, [178](#)
    - SLTU, [138](#), [140](#), [178](#)
    - SRL, [218](#)
    - SUBU, [142](#)
    - SW, [62](#)
  - Load delay slot, [167](#)
- O32, [62](#), [67](#), [1043](#)
- Pseudoinstructions
  - B, [195](#)
  - BEQZ, [140](#)
  - LA, [27](#)
  - LI, [8](#)
  - MOVE, [25](#), [84](#)
  - NEGU, [142](#)
  - NOP, [28](#), [84](#)
  - NOT, [211](#)
  - Registers
    - FCCR, [264](#)
    - HI, [504](#)
    - LO, [504](#)
- MS-DOS, [14](#), [33](#), [282](#), [608](#), [654](#), [714](#), [720](#), [728](#), [758](#), [846](#), [901](#), [902](#), [956](#), [1000](#), [1020](#), [1030](#), [1034](#), [1035](#)
  - DOS extenders, [1001](#)
- MSVC, [1044](#), [1045](#)
- MSVCRT.DLL, [915](#)
- Name mangling, [547](#)
- Native API, [759](#)
- Non-a-numbers (NaNs), [255](#)
- Notepad, [948](#)
- NSA, [464](#)
- objdump, [379](#), [752](#), [765](#), [791](#)
- octet, [448](#)
- OEP, [758](#), [765](#)
- OllyDbg, [45](#), [70](#), [79](#), [99](#), [111](#), [127](#), [170](#), [188](#), [204](#), [221](#), [234](#), [245](#), [268](#), [275](#), [278](#), [292](#), [293](#), [325](#), [346](#), [363](#), [364](#), [369](#), [372](#), [387](#), [762](#), [792](#), [1045](#)
- OOP
  - Polymorphism, [547](#)
- opaque predicate, [543](#)
- OpenMP, [636](#), [705](#)
- OpenSSL, [629](#), [863](#)
- OpenWatcom, [703](#), [737](#)
- Oracle RDBMS, [9](#), [408](#), [712](#), [768](#), [888](#), [895](#), [897](#), [968](#), [978](#), [995](#), [1001](#)
- Page (memory), [419](#)
- Pascal, [707](#)
- PDP-11, [440](#)
- PGP, [711](#)
- Phrack, [711](#)
- Pin, [527](#)
- PNG, [950](#)
- position-independent code, [19](#), [750](#)
- PowerPC, [2](#), [24](#), [829](#)
- Propagating Cipher Block Chaining, [868](#)
- Punched card, [265](#)
- puts() instead of printf(), [20](#), [72](#), [107](#), [134](#)
- Python, [527](#), [597](#)
  - ctypes, [743](#)
- Qt, [14](#)
- Quake, [528](#)
- Quake III Arena, [383](#)
- Racket, [1007](#)
- rada.re, [13](#)
- Radare, [792](#)
- radare2, [953](#)
- rafind2, [791](#)
- RAID4, [461](#)
- RAM, [82](#)
- Raspberry Pi, [18](#)
- ReactOS, [774](#)
- Recursion, [29](#), [31](#), [485](#)

- Tail recursion, [485](#)
- Register allocation, [422](#)
- Relocation, [22](#)
- Resource Hacker, [796](#)
- Reverse Polish notation, [265](#)
- RISC pipeline, [136](#)
- ROM, [82](#)
- ROT13, [854](#)
- row-major order, [292](#)
- RSA, [5](#)
- RVA, [758](#)
  
- SAP, [702](#), [884](#)
- Scheme, [1007](#)
- SCO OpenServer, [837](#)
- Scratch space, [739](#)
- Security cookie, [281](#), [780](#)
- Security through obscurity, [713](#)
- SHA1, [467](#)
- SHA512, [637](#)
- Shadow space, [101](#), [102](#), [429](#)
- Shellcode, [542](#), [749](#), [759](#), [902](#), [1038](#)
- Signed numbers, [125](#), [452](#)
- SIMD, [428](#), [517](#)
- Software cracking, [14](#), [152](#), [614](#)
- SQLite, [616](#)
- SSE, [428](#)
- SSE2, [428](#)
- Stack, [30](#), [98](#), [156](#)
  - Stack frame, [69](#)
  - Stack overflow, [31](#)
- stdcall, [735](#), [994](#)
- strace, [752](#), [792](#)
- strtoll(), [866](#)
- Stuxnet, [715](#)
- Syntactic Sugar, [155](#)
- syscall, [307](#), [748](#), [792](#)
- Sysinternals, [712](#), [793](#)
  
- Tabulation hashing, [463](#)
- Tagged pointers, [604](#)
- TCP/IP, [466](#)
- thiscall, [547](#), [548](#), [737](#)
- Thumb-2 mode, [21](#)
- thunk-functions, [22](#), [764](#), [830](#), [839](#)
- TLS, [282](#), [744](#), [760](#), [765](#), [1023](#)
  - Callbacks, [747](#), [765](#)
- Tor, [711](#)
- tracer, [189](#), [389](#), [391](#), [706](#), [717](#), [719](#), [776](#), [785](#), [792](#), [856](#), [886](#), [892](#), [896](#), [897](#), [899](#), [994](#)
- Turbo C++, [608](#)
  
- uClibc, [630](#)
- UCS-2, [449](#)
- UFS2, [715](#)
- Unicode, [708](#)
- UNIX
  - chmod, [4](#)
  - diff, [728](#)
  - fork, [631](#)
  - getopt, [866](#)
  - grep, [712](#), [994](#)
  - mmap(), [608](#)
  - od, [791](#)
  - strings, [712](#), [791](#)
  - xxd, [791](#), [931](#)
- Unrolled loop, [193](#), [284](#), [498](#), [500](#), [514](#)
- uptime, [752](#)
- UPX, [954](#)
- USB, [831](#)
- UseNet, [711](#)
- user space, [748](#)
- user32.dll, [154](#)
- UTF-16, [449](#)
- UTF-16LE, [708](#), [709](#)
- UTF-8, [708](#), [955](#)
- Uuencode, [955](#)
- Uuencoding, [711](#)
  
- VA, [758](#)
- Valgrind, [645](#)
- Variance, [852](#)
  
- Watcom, [703](#)
- win32
  - FindResource(), [604](#)
  - GetOpenFileName, [212](#)
  - GetProcAddress(), [616](#)
  - HINSTANCE, [616](#)
  - HMODULE, [616](#)
  - LoadLibrary(), [616](#)
  - MAKEINTRESOURCE(), [604](#)
- WinDbg, [792](#)
- Windows, [789](#)
  - API, [1020](#)
  - EnableMenuItem, [797](#)
  - IAT, [758](#)
  - INT, [758](#)
  - KERNEL32.DLL, [306](#)
  - MSVCR80.DLL, [385](#)
  - NTAPI, [797](#)
  - ntoskrnl.exe, [888](#)
  - PDB, [702](#), [760](#), [797](#), [805](#), [884](#)
  - Structured Exception Handling, [37](#), [766](#)
  - TIB, [282](#), [766](#), [1023](#)
  - Win32, [305](#), [709](#), [752](#), [758](#), [1001](#)
    - GetProcAddress, [764](#)
    - LoadLibrary, [764](#)
    - MulDiv(), [454](#), [814](#)
    - Ordinal, [762](#)
    - RaiseException(), [766](#)
    - SetUnhandledExceptionFilter(), [768](#)
  - Windows 2000, [759](#)
  - Windows 3.x, [650](#), [1001](#)
  - Windows NT4, [759](#)
  - Windows Vista, [758](#), [797](#)
  - Windows XP, [759](#), [765](#), [805](#)
- Windows 2000, [406](#)
- Windows 98, [154](#)
- Windows File Protection, [154](#)
- Windows Research Kernel, [407](#)
- Wine, [774](#)
- Wolfram Mathematica, [925](#)
  
- x86
  - AVX, [408](#)
  - Flags
    - CF, [34](#), [1028](#), [1031](#), [1032](#), [1035](#), [1036](#)
    - DF, [1032](#), [1036](#)
    - IF, [1032](#), [1036](#)

FPU, 1024  
 Instructions  
 AAA, 1039  
 AAS, 1039  
 ADC, 397, 654, 1028  
 ADD, 9, 43, 98, 505, 654, 1028  
 ADDSD, 429  
 ADDSS, 439  
 ADRcc, 144  
 AESDEC, 856  
 AESENC, 856  
 AESKEYGENASSIST, 858  
 AND, 10, 306, 310, 323, 337, 371, 1028, 1032  
 BSF, 420, 1032  
 BSR, 1032  
 BSWAP, 466, 1032  
 BT, 1032  
 BTC, 319, 1032  
 BTR, 319, 790, 1032  
 BTS, 319, 1032  
 CALL, 9, 31, 730, 763, 869, 944, 1028  
 CBW, 453, 1032  
 CDQ, 404, 453, 1032  
 CDQE, 453, 1032  
 CLD, 1032  
 CLI, 1032  
 CMC, 1032  
 CMOVcc, 136, 144, 145, 148, 151, 466, 1032  
 CMP, 87, 474, 1028, 1039  
 CMPSB, 715, 1032  
 CMPSD, 1032  
 CMPSQ, 1032  
 CMPSW, 1032  
 COMISD, 437  
 COMISS, 439  
 CPUID, 369, 1034  
 CWD, 453, 654, 913, 1032  
 CWDE, 453, 1032  
 DEC, 203, 1028, 1039  
 DIV, 453, 1034  
 DIVSD, 429, 718  
 FABS, 1036  
 FADD, 1036  
 FADDP, 220, 226, 1036  
 FATRET, 332, 333  
 FCHS, 1036  
 FCMOVcc, 257  
 FCOM, 244, 255, 1036  
 FCOMP, 232, 1036  
 FCOMPP, 1036  
 FDIV, 220, 716, 717, 1037  
 FDIVP, 220, 1037  
 FDIVR, 226, 1037  
 FDIVRP, 1037  
 FDUP, 685  
 FILD, 1037  
 FIST, 1037  
 FISTP, 1037  
 FLD, 230, 232, 1037  
 FLD1, 1037  
 FLDCW, 1037  
 FLDZ, 1037  
 FMUL, 220, 1037  
 FMULP, 1037  
 FNSTCW, 1037  
 FNSTSW, 232, 255, 1037  
 FSCALE, 382  
 FSINCOS, 1037  
 FSQRT, 1037  
 FST, 1037  
 FSTCW, 1037  
 FSTP, 230, 1037  
 FSTSW, 1037  
 FSUB, 1037  
 FSUBP, 1037  
 FSUBR, 1037  
 FSUBRP, 1037  
 FUCOM, 255, 1037  
 FUCOMI, 257  
 FUCOMP, 1037  
 FUCOMPP, 255, 1037  
 FWAIT, 218  
 FXCH, 996, 1037  
 IDIV, 453, 501, 1034  
 IMUL, 98, 301, 453, 454, 604, 1028, 1039  
 IN, 730, 846, 903, 1035  
 INC, 203, 994, 1028, 1039  
 INT, 33, 901, 1034  
 INT3, 706  
 IRET, 1034, 1035  
 JA, 125, 256, 453, 1028, 1039  
 JAE, 125, 1028, 1039  
 JB, 125, 453, 1028, 1039  
 JBE, 125, 1028, 1039  
 JC, 1028  
 Jcc, 97, 147  
 JCXZ, 1028  
 JE, 156, 1028, 1039  
 JECXZ, 1028  
 JG, 125, 453, 1028  
 JGE, 125, 1028  
 JL, 125, 453, 1028  
 JLE, 125, 1028  
 JMP, 31, 42, 55, 764, 994, 1028  
 JNA, 1028  
 JNAE, 1028  
 JNB, 1028  
 JNBE, 256, 1028  
 JNC, 1028  
 JNE, 87, 125, 1028, 1039  
 JNG, 1028  
 JNGE, 1028  
 JNL, 1028  
 JNLE, 1028  
 JNO, 1028, 1039  
 JNS, 1028, 1039  
 JNZ, 1028  
 JO, 1028, 1039  
 JP, 233, 1028, 1039  
 JPO, 1028  
 JRCXZ, 1028  
 JS, 1028, 1039  
 JZ, 95, 156, 995, 1028  
 LAHF, 1029  
 LEA, 69, 100, 351, 477, 488, 505, 740, 801,  
 869, 1029  
 LEAVE, 11, 1029  
 LES, 851, 912

LOCK, 789  
 LODSB, 903  
 LOOP, 184, 200, 718, 912, 1035  
 MAXSD, 437  
 MOV, 8, 10, 12, 514, 515, 730, 761, 869, 944, 994, 1030  
 MOVDQA, 411  
 MOVDQU, 411  
 MOVSB, 1030  
 MOVSD, 436, 516, 1030  
 MOVSDX, 436  
 MOVSQ, 1030  
 MOVSS, 439  
 MOVSW, 1030  
 MOVSX, 201, 209, 363-365, 453, 1030  
 MOVFXD, 286  
 MOVZX, 202, 348, 830, 1030  
 MUL, 453, 454, 604, 1030  
 MULSD, 429  
 NEG, 509, 1030  
 NOP, 488, 994, 1030, 1039  
 NOT, 207, 209, 1030  
 OR, 310, 530, 1030  
 OUT, 730, 846, 1035  
 PADDD, 411  
 PCMPEQB, 420  
 PLMULHW, 409  
 PLMULLD, 409  
 PMOVMSKB, 420  
 POP, 9, 30, 31, 1030, 1039  
 POPA, 1035, 1039  
 POPCNT, 1035  
 POPF, 903, 1035  
 PUSH, 9, 11, 30, 31, 69, 730, 869, 944, 1030, 1039  
 PUSHA, 1035, 1039  
 PUSHF, 1035  
 PXOR, 420  
 RCL, 718, 1035  
 RCR, 1035  
 RET, 6, 7, 10, 31, 281, 548, 651, 994, 1030  
 ROL, 333, 995, 1035  
 ROR, 995, 1035  
 SAHF, 255, 1030  
 SAL, 642, 1036  
 SAR, 337, 453, 521, 642, 912, 1036  
 SBB, 397, 1031  
 SCASB, 903, 1031  
 SCASD, 1031  
 SCASQ, 1031  
 SCASW, 1031  
 SET, 471  
 SETcc, 138, 202, 256, 1036  
 SHL, 213, 267, 337, 642, 1031  
 SHR, 217, 337, 371, 642, 1031  
 SHRD, 403, 1031  
 STC, 1036  
 STD, 1036  
 STI, 1036  
 STOSB, 500, 1031  
 STOSD, 1031  
 STOSQ, 515, 1031  
 STOSW, 1031  
 SUB, 10, 11, 87, 156, 474, 505, 1028, 1032  
 SYSCALL, 1034, 1036  
 SYSENTER, 749, 1034, 1036  
 TEST, 201, 306, 309, 337, 1032  
 UD2, 1036  
 XADD, 790  
 XCHG, 1030, 1036  
 XOR, 10, 87, 207, 521, 718, 842, 994, 1032, 1039  
 MMX, 408  
 Prefixes  
   LOCK, 790, 1027  
   REP, 1027, 1030, 1031  
   REPE/REPNE, 1027  
   REPNE, 1031  
 Registers  
   AF, 448  
   AH, 1029, 1030  
   CS, 1000  
   DF, 630  
   DR6, 1026  
   DR7, 1026  
   DS, 1000  
   EAX, 87, 107  
   EBP, 69, 98  
   ECX, 547  
   ES, 912, 1000  
   ESP, 43, 69  
   Flags, 87, 127, 1023  
   FS, 745  
   GS, 282, 745, 748  
   JMP, 174  
   RIP, 751  
   SS, 1000  
   ZF, 87, 306  
 SSE, 408  
 SSE2, 408  
 x86-64, 14, 15, 51, 68, 73, 94, 100, 421, 428, 731, 738, 751, 1020, 1026  
 Xcode, 18  
 XML, 711, 851  
 XOR, 857  
 Z80, 448  
 zlib, 630, 854  
 Zobrist hashing, 463  
 ZX Spectrum, 458